

# MECCANO



SUPPLEMENTARY  
MANUAL OF INSTRUCTIONS

MANUAL D'INSTRUCTIONS  
SUPPLÉMENTAIRES

Price  
Prix 0.35

No. 14 S.  
PRINTED IN ENGLAND  
IMPRIMÉ EN ANGLETERRE

MECCANO LIMITED, LIVERPOOL, ENG.

COPYRIGHT 1916  
MECCANO LTD.  
DEPOSE 1916



### Buffers—Tampons

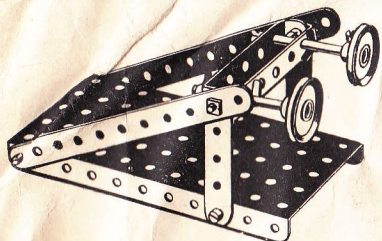

2 No. 2	4 No. 35
2 " 5	6 " 37
2 " 17	1 " 52
2 " 22	2 " 60

### Torpedo Destroyer Contre-Torpilleur

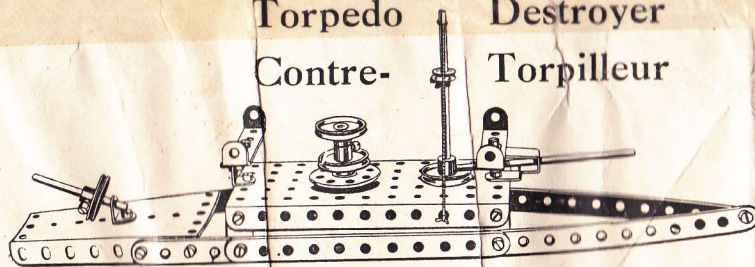

4 No. 2	1 No. 17	19 No. 37
2 " 5	4 " 22	1 " 44
4 " 10	1 " 23	1 " 52
1 " 11	1 " 24	1 " 54
1 " 12	3 " 35	2 " 60
2 " 15A		

### Scales—Balance

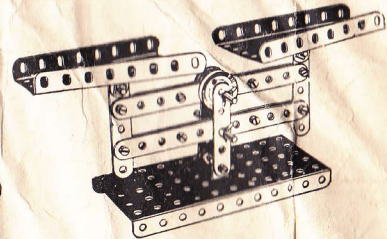

4 No. 2	2 No. 22A
8 " 5	4 " 35
1 " 11	19 " 37
2 " 12	1 " 52
2 " 17	2 " 54

### Metal Saw Scie à Métaux

4 No. 2	1 No. 19
5 " 5	2 " 22
1 " 10	1 " 24
8 " 12	2 " 35
1 " 17	23 " 37
	1 No. 52
	2 " 60

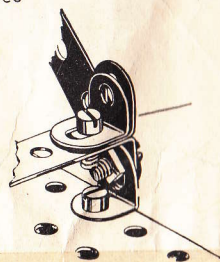
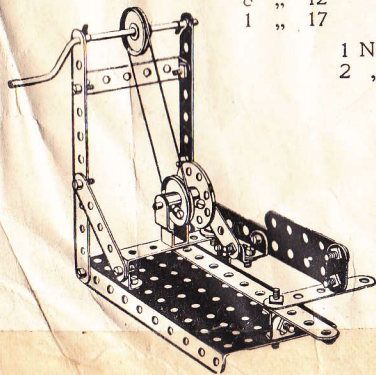

### Anchor Ancre

2 No. 2
3 " 5
4 " 10
4 " 12
11 " 37
1 " 57

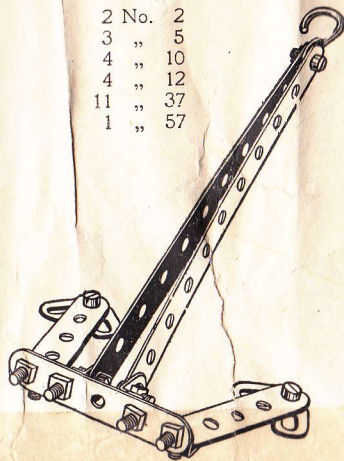

### Stamping Machine Machine à Estamper

4 No. 2
8 " 5
2 " 12
2 " 15A
1 " 19
4 " 22
1 " 24
3 " 35
20 " 37
1 " 52
2 " 60

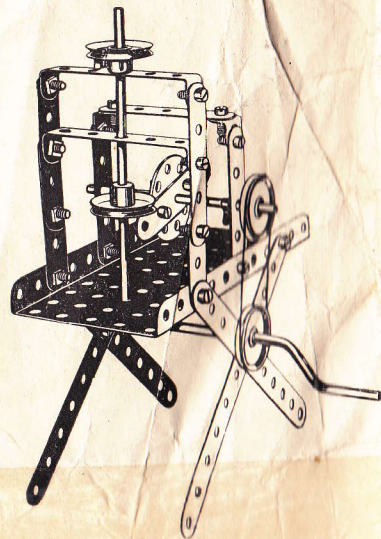



### Sharpshooter Gun Canon de Précision

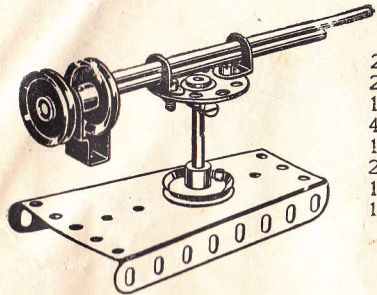

- 2 No. 12
- 2 " 15A
- 1 " 17
- 4 " 22
- 1 " 24
- 2 " 37
- 1 " 44
- 1 " 54

### Spinning Top Devidoir à Fil

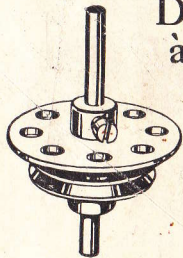

- 1 No. 17
- 1 " 22
- 1 " 24

### Roulette Wheel Roulette

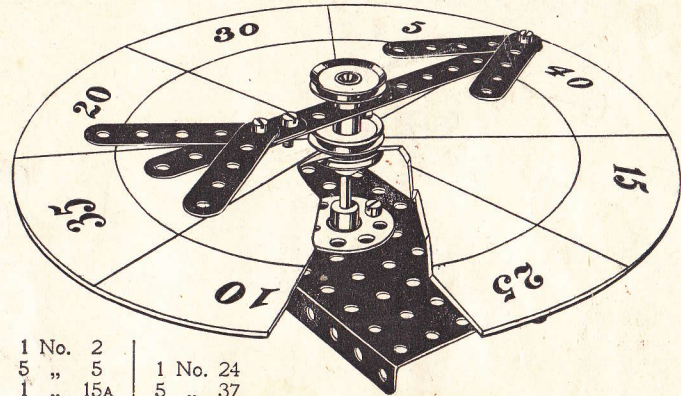

- |         |          |
|---------|----------|
| 1 No. 2 | 1 No. 24 |
| 5 " 5   | 5 " 37   |
| 1 " 15A | 1 " 52   |
| 3 " 22  |          |

### Anti-Aircraft Gun Canon Anti Avion

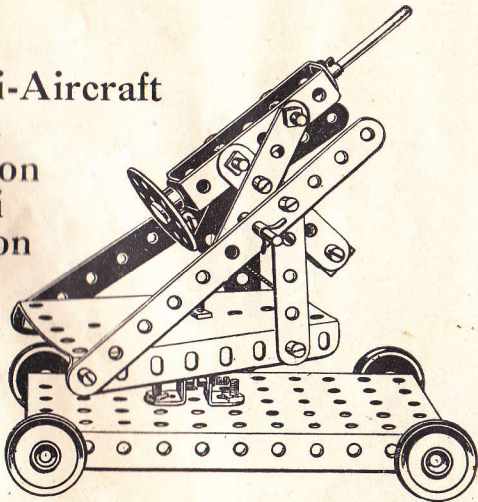

- |         |          |          |
|---------|----------|----------|
| 2 No. 2 | 4 No. 22 | 1 No. 44 |
| 6 " 5   | 1 " 24   | 1 " 52   |
| 4 " 12  | 5 " 35   | 1 " 54   |
| 2 " 15A | 23 " 37  | 2 " 60   |

### Band Saw Scie à Ruban

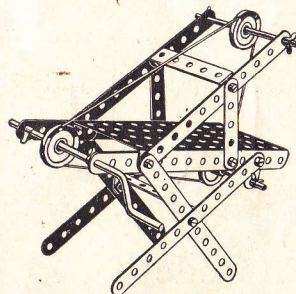

- |         |          |
|---------|----------|
| 6 No. 2 | 3 No. 22 |
| 4 " 5   | 6 " 35   |
| 2 " 10  | 10 " 37  |
| 2 " 15A | 1 " 52   |
| 1 " 19  | 2 " 60   |

### Punching Machine Emporte Pièce

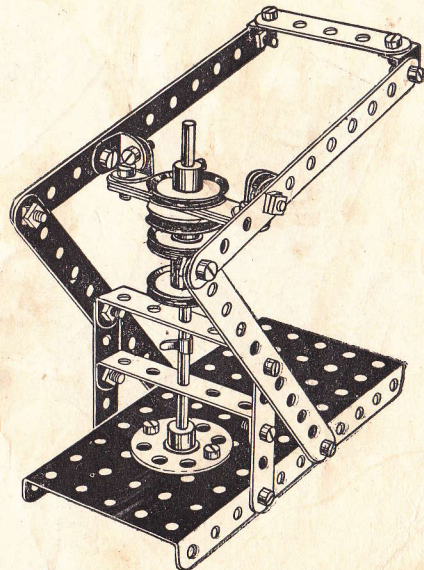

- 4 No. 2
- 7 " 5
- 6 " 12
- 1 " 15A
- 4 " 22
- 1 " 24
- 1 " 35
- 22 " 37
- 1 " 52
- 2 " 60

- 2
- 5
- 10
- 12
- 15A
- 22
- 37
- 52
- 54
- 60



### Timber Drag Triqueballe

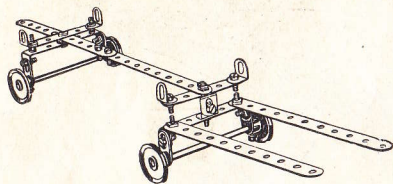

4 No. 2	4 No. 22
4 " 10	18 " 37
6 " 12	3 " 60
2 " 15A	

### Steering Truck Truck sur Essieux Mobiles

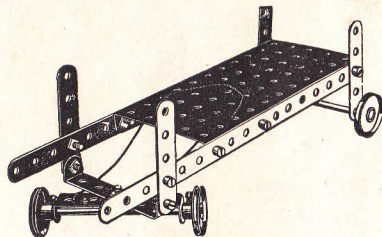

2 No. 2	11 No. 37
4 " 5	1 " 52
2 " 15A	2 " 60
4 No. 22	

### Boiler Truck Truck pour Chaudières

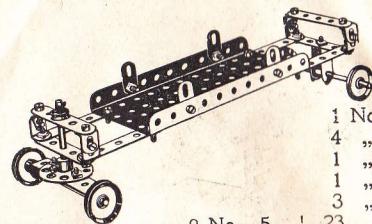

	1 No. 17
	4 " 22
	1 " 23
	1 " 24
	3 " 35
8 No. 5	23 " 37
4 " 10	1 " 44
8 " 12	1 " 52
2 " 15A	1 " 60

### Rocking Chair

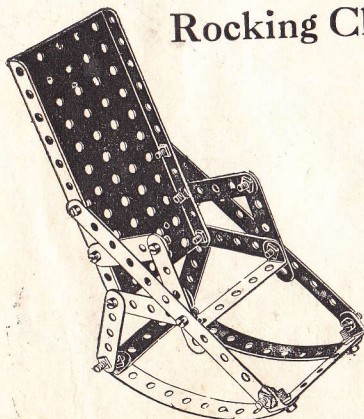

4 No. 2	18 No. 37
9 " 5	1 " 52
2 " 12	1 " 60

### Lurry—Wagonnette

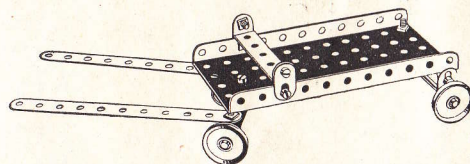

2 No. 2	13 No. 37
4 " 10	1 " 24
2 " 12	1 " 52
2 " 15A	2 " 60
4 No. 22	

### Telegraph Code Key Clavier de Code Télégraphique

3 No. 2	1 No. 22
1 " 10	12 " 37
5 " 12	1 " 52

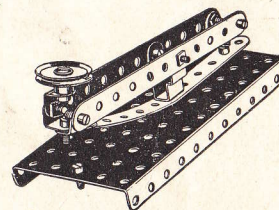

### Watch Stand Porte-Montre

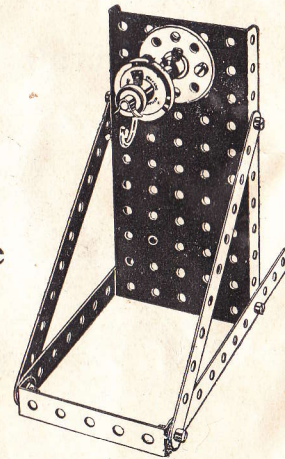

4 No. 2	1 No. 35
1 " 17	8 " 37
1 " 22	1 " 52
1 " 23	1 " 57
1 " 24	1 " 60



**Drop Hammer**  
Marteau à Déclic

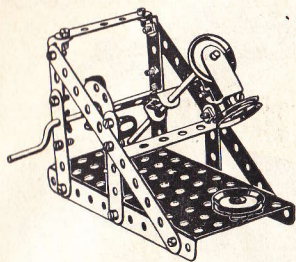

2 No. 2	3 No. 22
7 " 5	1 " 24
6 " 12	23 " 37
1 " 15A	1 " 44
1 " 19	1 " 52
2 No. 60	

**Furrowing Roller**  
Sillonneuse

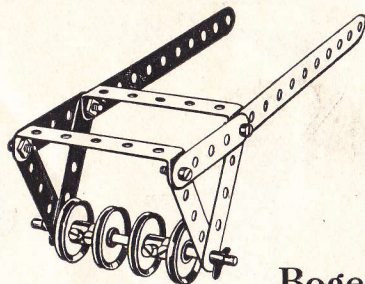

**Bogey Truck**  
Truck à Bogie

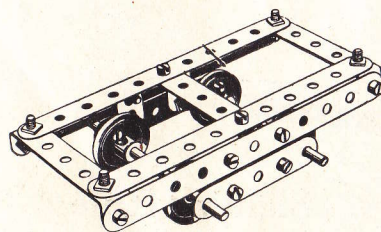

4 No. 2	4 No. 22
3 " 5	18 " 37
4 " 10	2 " 60
2 " 15A	

**Hay Tedder**  
Petite Faneuse

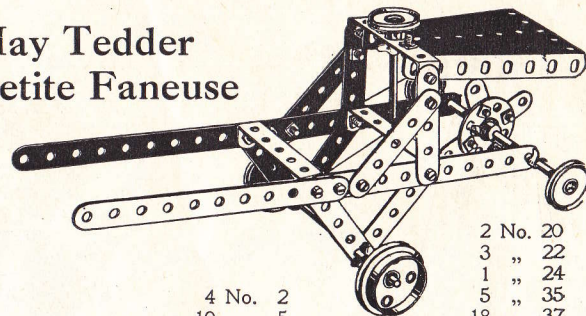

4 No. 2	2 No. 20
10 " 5	3 " 22
2 " 15A	1 " 24
1 " 17	5 " 35
	18 " 37
	1 " 54
	3 " 60

**Sleigh—Traineau**

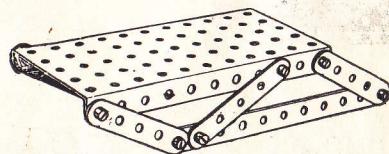

2 No. 2
6 " 5
12 " 37
1 " 52

**Double-Drop Hammer**

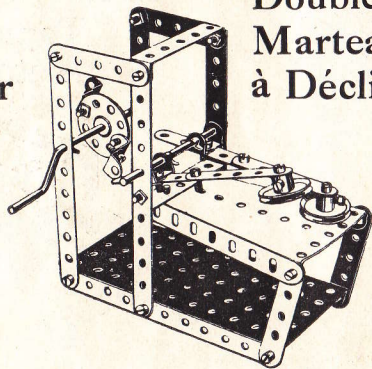

**Double-Marteau à Déclic**

4 No. 2	1 No. 19	22 No. 37
8 " 5	2 " 22	1 " 52
8 " 12	1 " 24	1 " 54
1 " 15A	4 " 35	2 " 60

**Ticca Gharry**  
Pousse-Pousse Indien

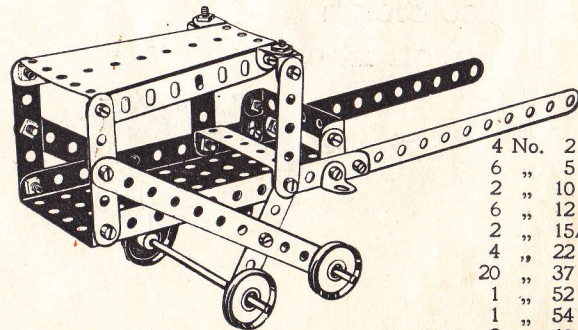

4 No. 2
6 " 5
2 " 10
6 " 12
2 " 15A
4 " 22
20 " 37
1 " 52
1 " 54
2 " 60

**Grill—Gril**

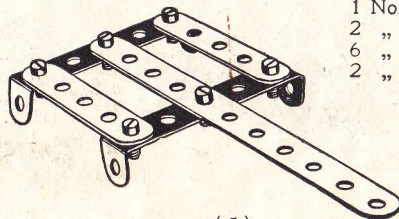

1 No. 2
2 " 5
6 " 37
2 " 60



## Gong

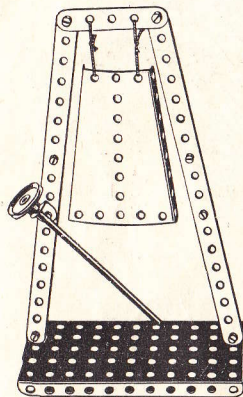

2	No.	2
1	"	5
3	"	12
1	"	15A
1	"	22
10	"	37
1	"	52
1	"	54

## Invalid Chair Chaise de Malade

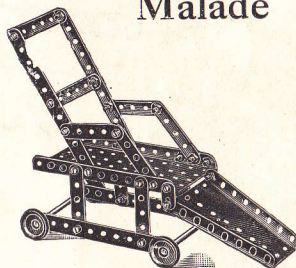

4	No.	2	22	No.	37
8	"	5	1	"	52
2	"	10	1	"	54
2	"	15A	2	"	60
4	"	22			

## Deck Chair Chaise de Pont

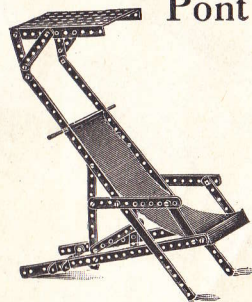

4	No.	1	1	No.	15A
4	"	2	30	"	37
1	"	3	1	"	52
6	"	5	2	"	60
6	"	12			

## Rock Drill Foret à Roc

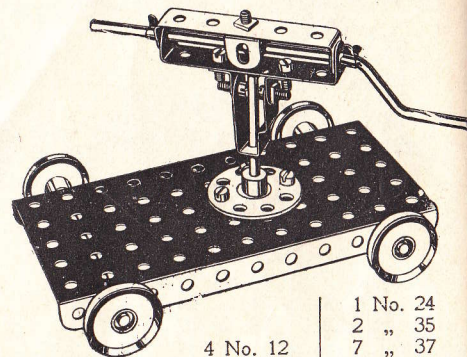

4	No.	12	1	No.	24
1	"	15A	2	"	35
1	"	19	7	"	37
4	"	22	1	"	44
			1	"	52
			2	"	60

## Hatchet Hachette

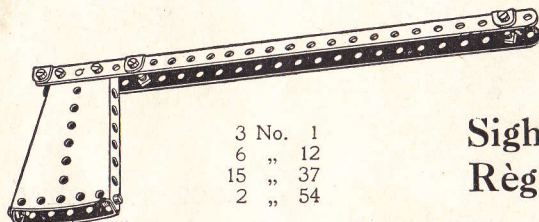

3	No.	1
6	"	12
15	"	37
2	"	54

## Horse Sleigh Traineau Hippomobile

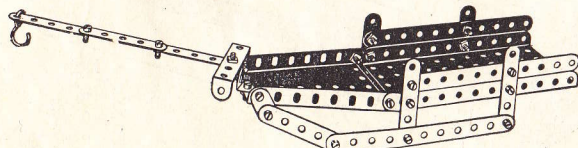

4	No.	2	25	No.	37
9	"	5	1	"	52
4	"	10	1	"	54
2	"	12	1	"	57

## Sighting Rule Règle-Mireuse

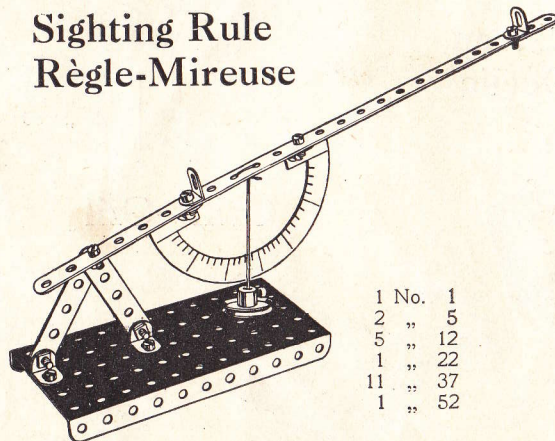

1	No.	1
2	"	5
5	"	12
1	"	22
11	"	37
1	"	52

## Motor Van Tapissière Automobile

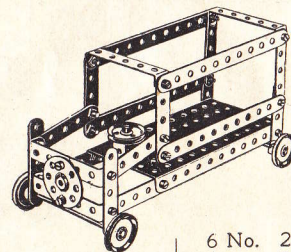

6	No.	2
1	"	3
9	"	5
1	"	11
4	"	22
1	"	22A
1	"	24
22	"	37
1	"	52
4	"	60



### Invalid Chair Chaise d'Invalide

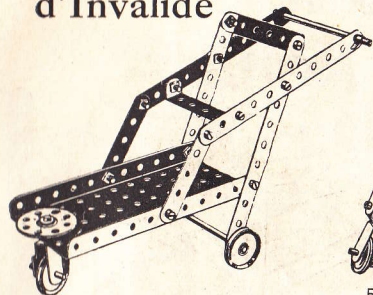

4 No. 2	1 No. 24
2 " 5	2 " 35
2 " 15A	13 " 37
1 " 18	1 " 44
3 " 22	2 " 60

### Foot Cycle Patinette

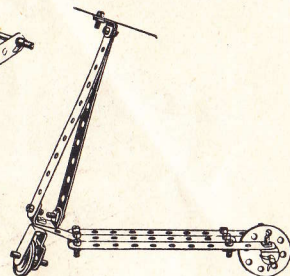

5 No. 2	1 No. 22
1 " 5	1 " 24
4 " 10	4 " 35
1 " 11	15 " 37
3 " 12	1 " 44
2 " 17	

### Coster's Barrow Voiture- Fruitière

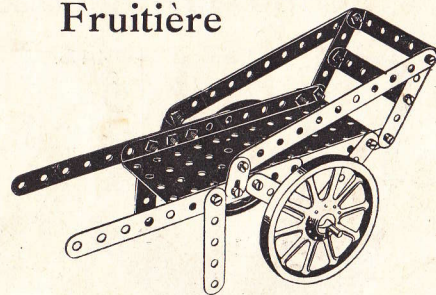

4 No. 2	4 No. 35
8 " 5	16 " 37
2 " 10	1 " 52
1 " 15A	2 " 60
2 " 19A	

### Cart Charrette

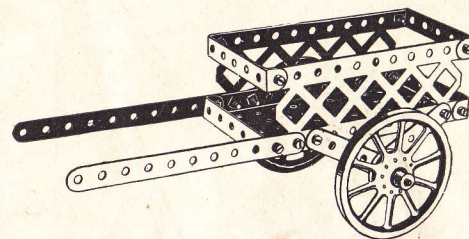

4 No. 2	2 No. 22	2 No. 59
4 " 5	15 " 37	4 " 60
1 " 15	1 " 44	2 " 100
2 " 19A	1 " 52	

### Mail Bag Hanger Porte- manteau

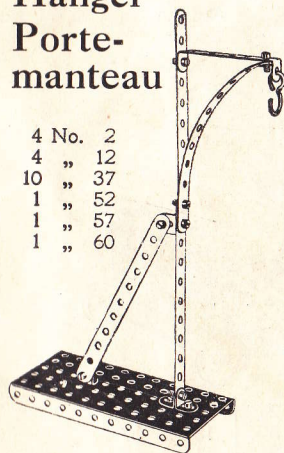

4 No. 2
4 " 12
10 " 37
1 " 52
1 " 57
1 " 60

### Bed Table Somno

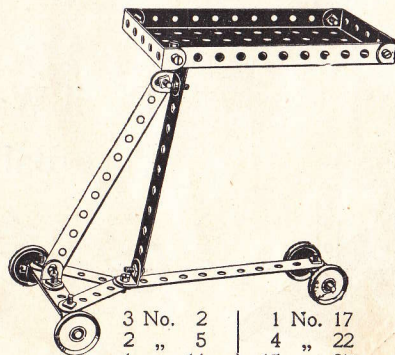

3 No. 2	1 No. 17
2 " 5	4 " 22
1 " 11	15 " 37
4 " 12	1 " 52
1 " 15A	3 " 60

### Motor Lurry Wagonette Automobile

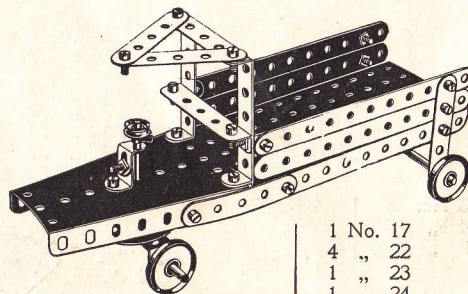

	1 No. 17
	4 " 22
	1 " 23
	1 " 24
	2 " 35
	25 " 37
4 No. 2	1 " 52
8 " 5	1 " 54
8 " 12	2 " 60
2 " 15A	

### Forge Bellows Forge à Soufflets

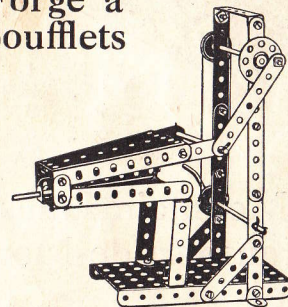

4 No. 2	1 No. 19
1 " 3	2 " 22
2 " 5	1 " 24
2 " 10	5 " 35
1 " 11	25 " 37
2 " 12	1 " 52
2 " 15A	2 " 54
1 " 17	3 " 60



**Jib Crane**  
**Grue à Flèche**

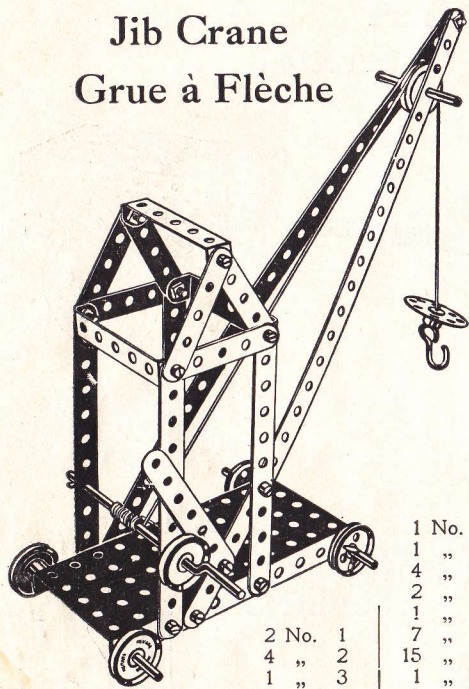

1 No. 17	
1 " 19	
4 " 22	
2 " 22A	
1 " 24	
7 " 35	
15 " 37	
1 " 52	
1 " 57	
2 " 15A	3 " 60

**Lawn Mower**      **Tondeuse à Gazon**

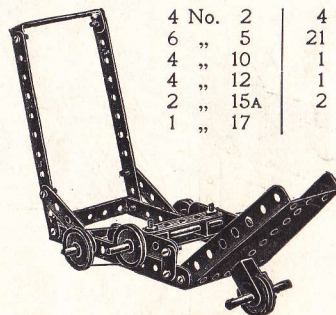

4 No. 2	4 No. 22
6 " 5	21 " 37
4 " 10	1 " 44
4 " 12	1 " 54
2 " 15A	2 " 60
1 " 17	

**Maize Sheller**  
**Décortiqueuse**

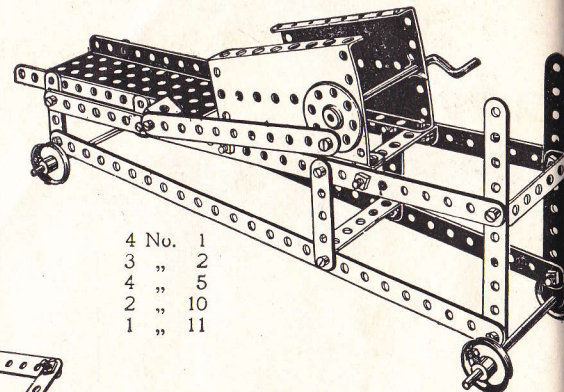

4 No. 1
3 " 2
4 " 5
2 " 10
1 " 11

**Music Stand**  
**Pupitre à Musique**

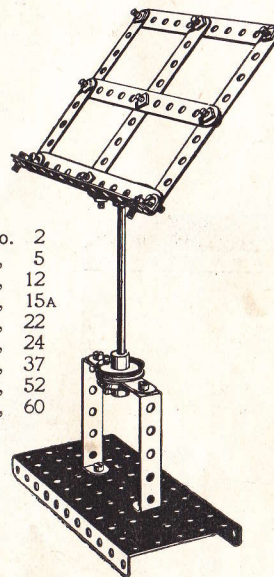

4 No. 2
7 " 5
3 " 12
1 " 15A
2 " 22
1 " 24
16 " 37
1 " 52
2 " 60

2 No. 15	26 No. 37
1 " 19	1 " 52
4 " 22	2 " 54
1 " 24	4 " 60
2 " 35	

**Mountain Transport**  
**Transport de Montagne**

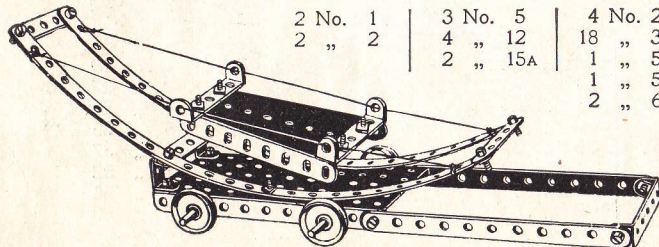

2 No. 1	3 No. 5	4 No. 22
2 " 2	4 " 12	18 " 37
	2 " 15A	1 " 52
		1 " 54
		2 " 60

**Devil Wall**  
**Pare-Balles**

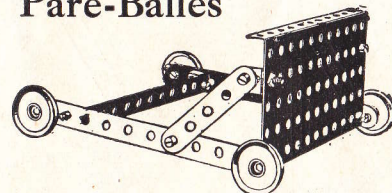

3 No. 2	4 No. 22
2 " 5	18 " 37
6 " 12	1 " 52



## Mechanical Hammers Marteaux Mécaniques

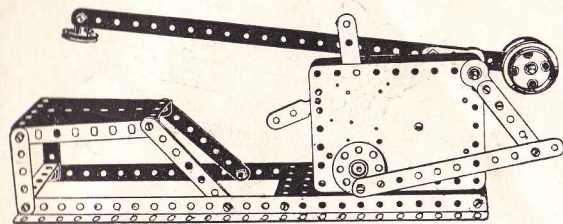

1 No. 1	4 No. 12	26 No. 37
1 " 2	1 " 17	1 " 52
2 " 3	2 " 20	1 " 54
2 " 5	1 " 22	1 " 60
2 " 8	1 " 24	2 " 62

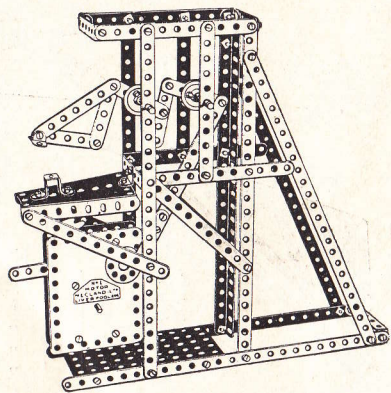

6 No. 1
11 " 2
1 " 3
7 " 5
2 " 8
3 " 12
2 " 15 <sup>A</sup>
4 " 22
1 " 24
4 " 35
48 " 37
1 " 45
1 " 52
1 " 54
2 " 60

## Baby Chair Chaise d'Enfant

8 No. 2
2 " 3
10 " 5
6 " 12
2 " 17
4 " 22
32 " 37
6 " 60

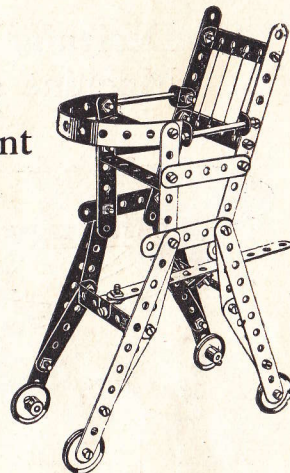

## Needlework Basket Travaillouse

4 No. 1
6 " 2
2 " 3
6 " 5
12 " 12
46 " 37
1 " 52
3 " 60

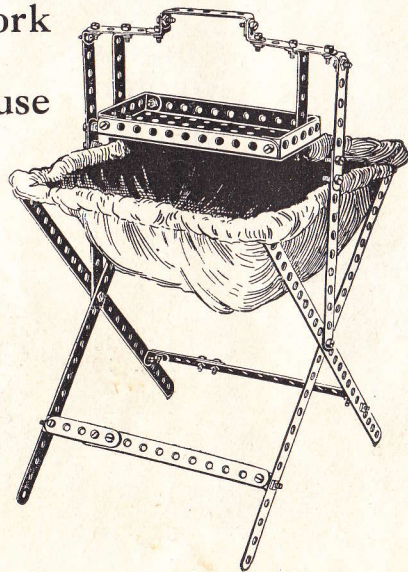

## Candy Puller Etireuse de Pâte de Guimauve

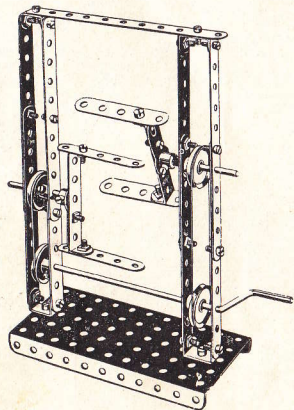

9 No. 2
4 " 5
4 " 11
2 " 17
1 " 19
4 " 22
2 " 35
26 " 37
1 " 52
1 " 60
2 " 62

## Try-your-Strength Machine Enregistreur de Force Musculaire

2 No. 1
3 " 2
2 " 5
2 " 8
4 " 12
1 " 16
2 " 17
1 " 18
4 " 22
1 " 24
29 " 37
1 " 44
1 " 45
1 " 52
1 " 54
4 " 60
1 " 62

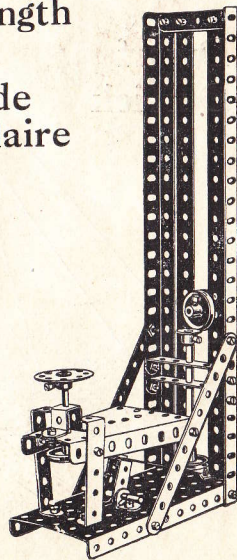



## Designing Machine Machine à Dessiner

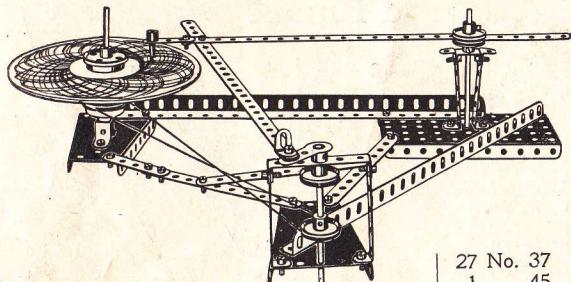

2 No. 1	1 No. 12	4 No. 22	27 No. 37
3 " 2	2 " 15A	1 " 24	1 " 45
2 " 8	1 " 16	1 " 24	1 " 52
1 " 11	1 " 20	1 " 35	2 " 54
			5 " 60
			2 " 62

## Crossbow—Arbalète

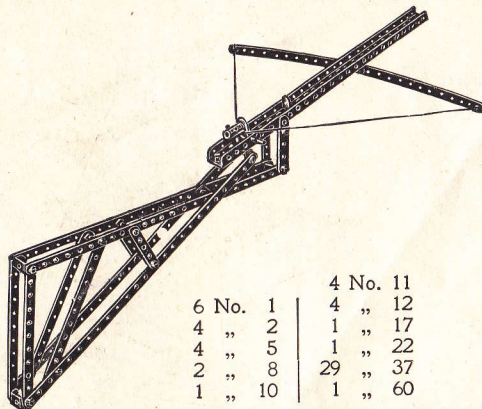

6 No. 1	4 No. 11
4 " 2	4 " 12
4 " 5	1 " 17
2 " 8	1 " 22
1 " 10	29 " 37
	1 " 60

## Lathe—Tour

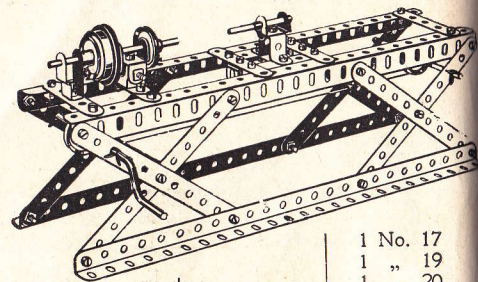

8 No. 2	4 No. 8	1 No. 17
7 " 5	3 " 11	1 " 19
	4 " 12	1 " 20
	1 " 15A	4 " 22
	1 " 16	6 " 35
		41 " 37
		1 " 44
		1 " 45

## Dwarf Derrick

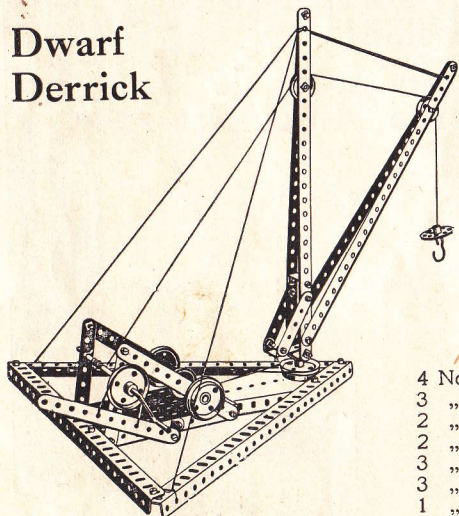

4 No. 1	1 No. 19
3 " 2	4 " 20
2 " 3	2 " 22
2 " 5	2 " 22A
3 " 8	1 " 23
3 " 11	1 " 24
1 " 15A	4 " 35
1 " 17	39 " 37
	1 " 45
	1 " 52
	1 " 54
	1 " 57
	1 " 62

## Derrick Nain

## Potato Reaper Recolteuse de Patates

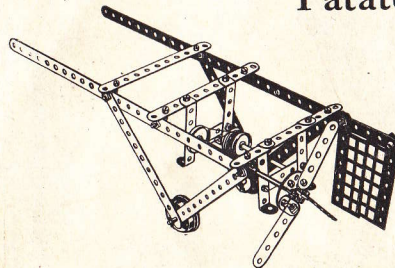

2 No. 1	1 No. 15A	5 No. 35
8 " 2	2 " 20	31 " 37
4 " 5	2 " 22	4 " 60
10 " 12	2 " 22A	2 " 61
2 " 15	1 " 24	

## Embossing Machine Machine à Gaufrer

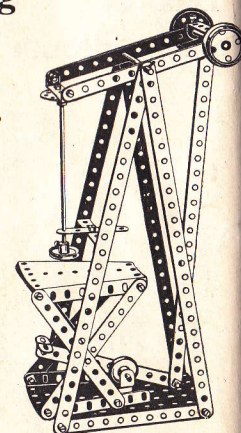

5 No. 1
7 " 2
1 " 5
1 " 15
2 " 15A
1 " 18
2 " 20
2 " 22
1 " 24
4 " 35
23 " 37
1 " 44
1 " 52
2 " 54
3 " 60



Gong

- 6 No. 1
- 4 " 2
- 2 " 5
- 2 " 8
- 2 " 11
- 1 " 15
- 1 " 22
- 27 " 37
- 1 " 54

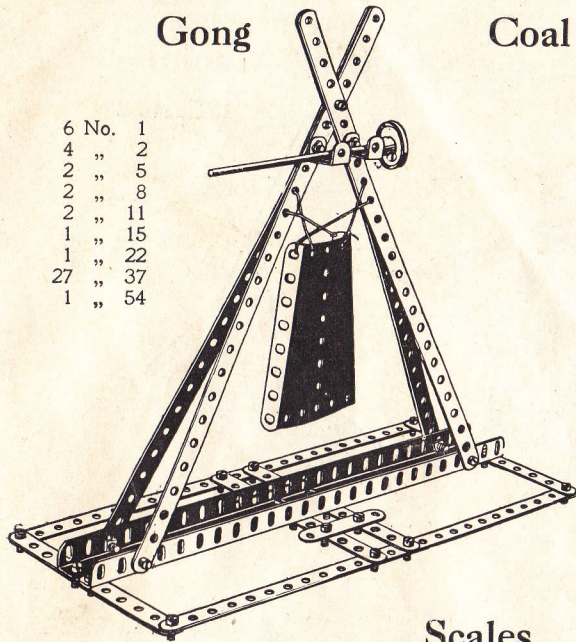

Coal Shaker

Cribleur à Charbon

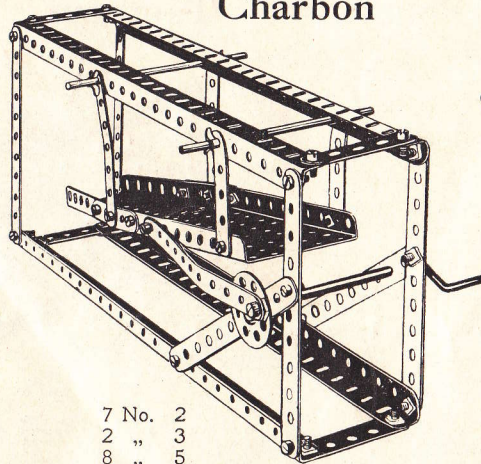

- |         |          |
|---------|----------|
| 7 No. 2 |          |
| 2 " 3   |          |
| 8 " 5   |          |
| 4 " 8   |          |
| 2 " 15A | 5 No. 35 |
| 1 " 19  | 30 " 37  |
| 1 " 24  | 1 " 52   |
|         | 1 " 54   |

Hay Stacker  
Faneuse

- |          |          |
|----------|----------|
| 11 No. 2 | 4 No. 12 |
| 1 " 3    | 1 " 16   |
| 12 " 5   | 2 " 20   |
| 4 " 8    | 2 " 35   |
|          | 41 " 37  |
|          | 1 " 52   |

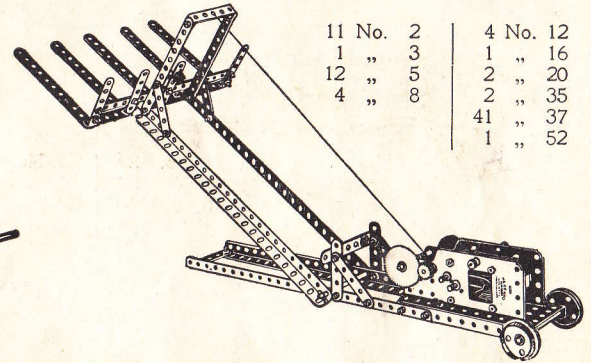

Scales  
Balance

- 1 No. 1
- 6 " 2
- 5 " 5
- 4 " 10
- 4 " 12
- 1 " 17
- 2 " 22A
- 2 " 35
- 32 " 37
- 1 " 52
- 2 " 54
- 5 " 60

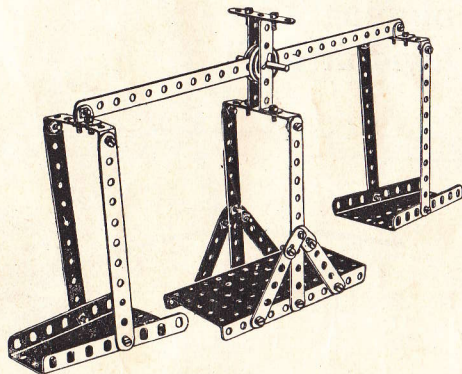

Coaster  
Côtier

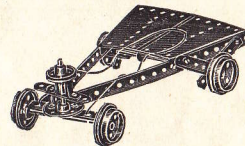

- 2 No. 2
- 5 " 5
- 1 " 15
- 1 " 16
- 1 " 17
- 4 " 20
- 1 " 22
- 1 " 24
- 1 " 37
- 1 " 45
- 2 " 54
- 1 " 60

Aéroplage

- 3 No. 1
- 1 " 2
- 3 " 5
- 4 " 12
- 1 " 15
- 4 " 16
- 2 " 22
- 1 " 22A
- 6 " 24
- 1 " 35
- 15 " 37
- 1 " 44
- 1 " 52
- 1 " 54
- 2 " 60

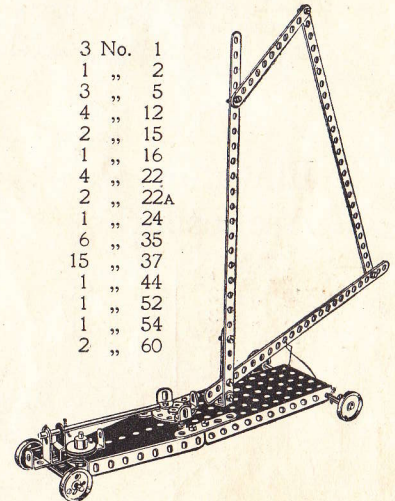



Ducking Chair  
Charrette de Poney

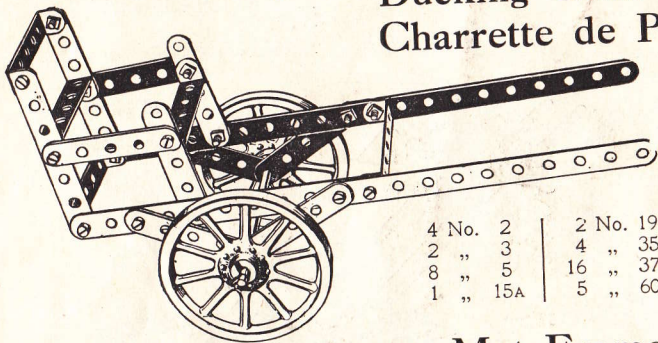

4 No.	2	2 No.	19A
2 "	3	4 "	35
8 "	5	16 "	37
1 "	15A	5 "	60

Mat Frame  
Câdre à Tisser

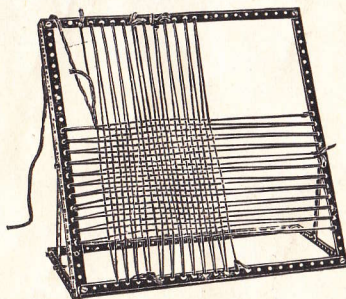

1 No.	1
4 "	2
4 "	8
2 "	12
14 "	37

Elevator  
Ascenseur

1 No.	1	2 No.	22A
10 "	2	5 "	35
1 "	3	44 "	37
10 "	5	1 "	44
4 "	8	1 "	52
4 "	12	2 "	54
1 "	15A	5 "	60
1 "	17		
1 "	19		
1 "	22		

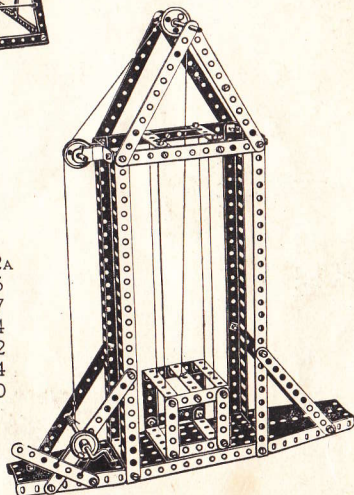

Sifter  
Tamiseur

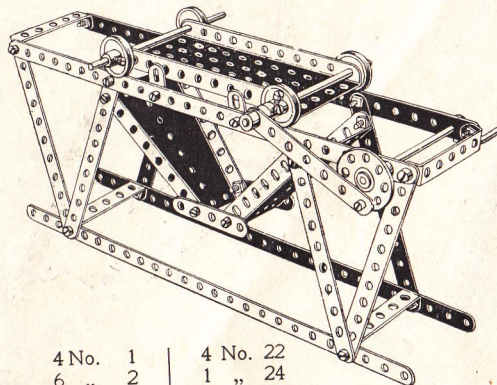

4 No.	1	4 No.	22
6 "	2	1 "	24
1 "	3	4 "	35
2 "	5	26 "	37
4 "	10	1 "	52
2 "	15A	2 "	54
1 "	19	4 "	60

Cutting Machine  
Cisailles

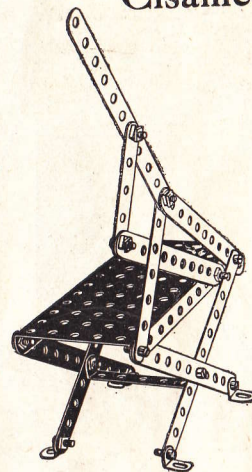

8 No.	2
1 "	3
1 "	5
4 "	12
20 "	37
1 "	52

Spinning Top  
Dévidoir à Fil

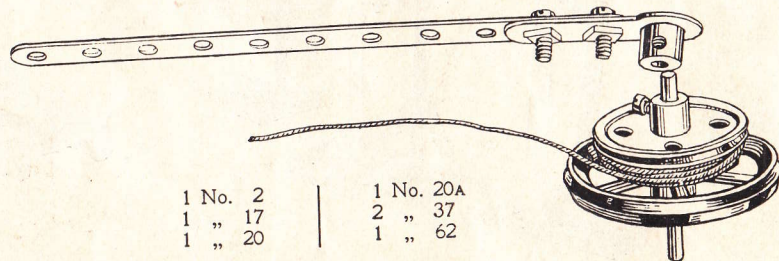

1 No.	2	1 No.	20A
1 "	17	2 "	37
1 "	20	1 "	62



### Locomotive

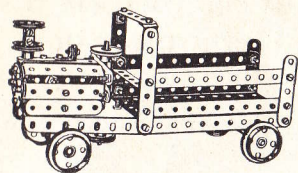

4 No. 2	1 No. 16	46 No. 37
2 " 3	1 " 17	1 " 45
7 " 5	4 " 20	1 " 52
4 " 10	4 " 22	1 " 54
1 " 11	1 " 23	6 " 60
8 " 12	1 " 24	2 " 62
2 " 15A	3 " 35	

### Easel Chevalet

5 No. 1
2 " 2
2 " 3
1 " 5
2 " 12
14 " 37
1 " 60

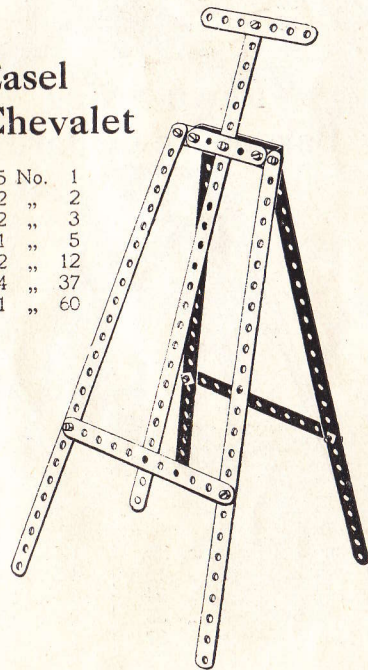

### Flax Cleaner

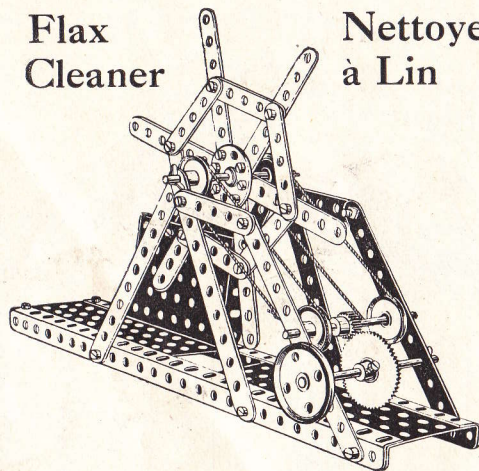

6 No. 2
6 " 3
8 " 5
2 " 8
1 " 15A
2 " 16
1 " 21
4 " 22
1 " 24
1 " 26
1 " 27A
3 " 35
28 " 37
2 " 52

### Coffee Grinder Moulin à Café

1 No. 1	2 No. 17
2 " 2	1 " 24
6 " 3	2 " 26
2 " 4	28 " 37
4 " 5	2 " 54
4 " 12	4 " 59
1 " 15	2 " 62
1 " 16	

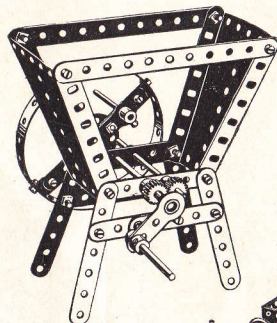

### Wire Rope Maker Machine à faire le câble en fil de fer

2 No. 2	3 No. 15
1 " 3	2 " 15A
10 " 5	2 " 19
3 " 11	4 " 20
8 " 12	1 " 24

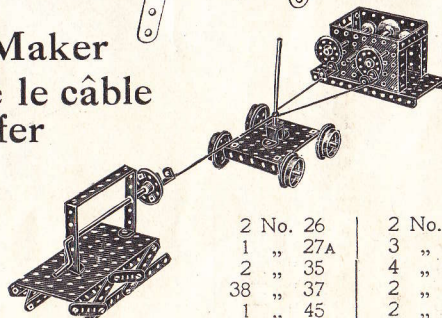

2 No. 26	2 No. 52
1 " 27A	3 " 53
2 " 35	4 " 59
38 " 37	2 " 60
1 " 45	2 " 62

### Oscillating Steam Engine

### Machine à Vapeur Oscillante

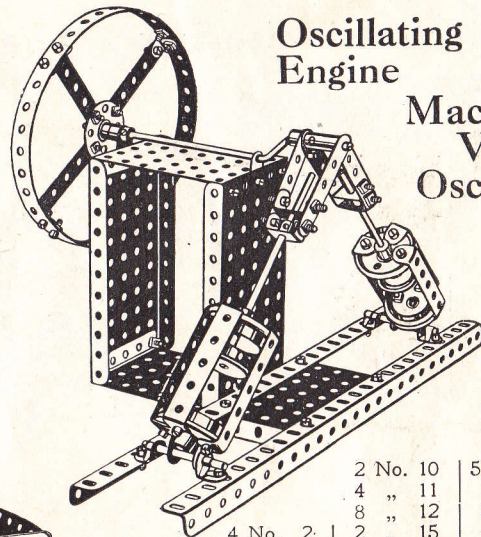

4 No. 20	2 " 22	1 " 24	2 " 37	4 " 54	2 " 52	3 " 53	4 " 59	6 " 60	1 " 63
2 No. 10	4 " 11	8 " 12	2 " 15	2 " 17	1 " 19				

### Lace Jennier Métier à Dentelle

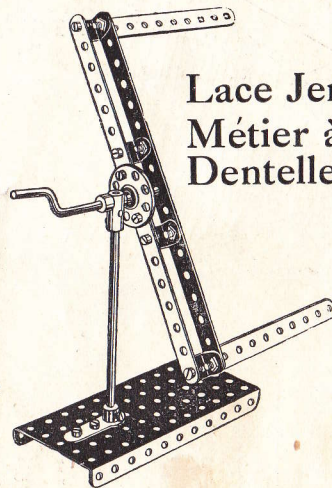

8 No. 2
4 " 11
1 " 15
1 " 19
1 " 24
14 " 37
1 " 52
1 " 59
1 " 62
1 " 63



## Actuated See-Saw Balancoire à va-et-vient Horizontal

1 No.	2
2 "	3
8 "	8
3 "	15
3 "	15A
4 "	20
1 "	21
1 "	22
1 "	24
1 "	26
1 "	27

4 No.	35
27 "	37
2 "	52
3 "	53
4 "	59
1 "	62

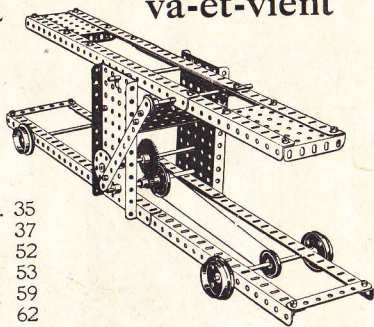

## Tip Wagon Wagon Basculant

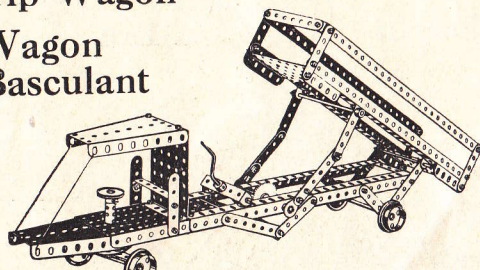

2 No.	1
1 "	2
6 "	3
2 "	4
11 "	5
4 "	8
9 "	12

4 No.	15
2 "	15A
1 "	16
1 "	17
4 "	20
1 "	21
3 "	22

1 No.	23
1 "	24
1 "	26
1 "	27
4 "	35
1 "	37
1 "	45

2 No.	52
3 "	53
1 "	54
4 "	59
6 "	60
2 "	62

## Demonstration Scales Balance de Démonstration

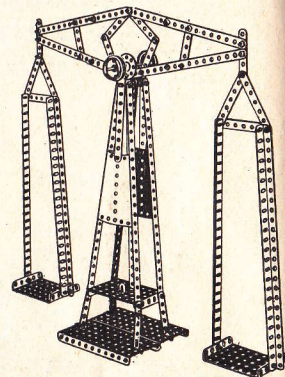

5 No.	1
10 "	2
6 "	3
12 "	5
4 "	8
2 "	11
5 "	12
1 "	16
2 "	20
1 "	24
49 "	37
2 "	52
3 "	53
2 "	54

## Ice Boat Yacht- Traineau

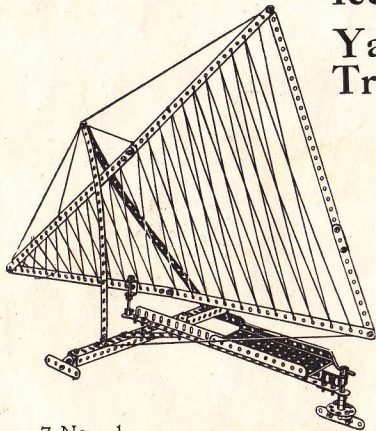

7 No.	1
1 "	2
2 "	3
3 "	5
2 "	8
2 "	10

3 No.	11
6 "	12
2 "	17
1 "	19
1 "	24

39 No.	37
1 "	52
3 "	59
2 "	62
1 "	63

## Motor Dump Truck Truck-Deversoir- Automobile

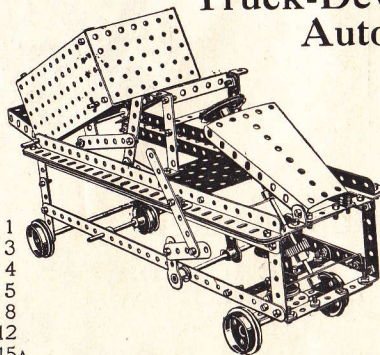

2 No.	1
6 "	3
2 "	4
12 "	5
4 "	8
6 "	12
3 "	15A
2 "	16
1 "	17
1 "	19
4 "	20
1 "	22
1 "	24

1 No.	27
1 "	32
2 "	35
54 "	37
1 "	45
1 "	52

3 No.	53
2 "	54
4 "	59
4 "	60
2 "	62
1 "	63

## Lawn Swing Balancoire de Jardin

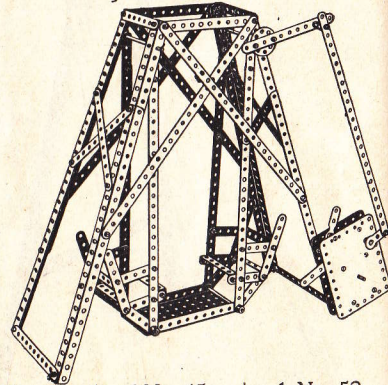

9 No.	1
9 "	2
6 "	3
12 "	5
8 "	8

2 No.	15A
2 "	16
1 "	24
6 "	35
65 "	37

1 No.	52
4 "	59
6 "	60
2 "	62
1 "	63



**"Drop the Nigger"  
"Lachez le Nègre"**

1	No.	1
6	"	3
8	"	8
1	"	12
3	"	15A
1	"	17
1	"	22
6	"	35
33	"	37
1	"	44
2	"	53
2	"	54
3	"	59
4	"	60
1	"	63

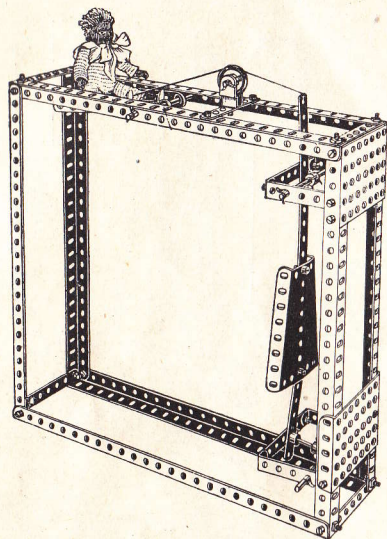

**Perambulator  
Voiturette**

3	No.	1
10	"	2
12	"	5
2	"	10
12	"	12
3	"	15A
1	"	16
4	"	19A
2	"	22
10	"	35
45	"	37
1	"	52
3	"	60



**Conductor's  
Punch**

**Poinçon  
de  
Rece-  
veur**

3	No.	5
1	"	11
1	"	15A
1	"	22
9	"	37
1	"	43
2	"	53
1	"	59

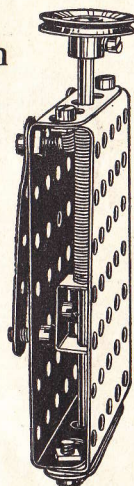

**Rattle  
Crécelle**

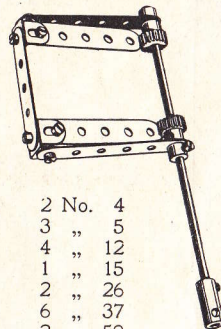

2	No.	4
3	"	5
4	"	12
1	"	15
2	"	26
6	"	37
2	"	59
1	"	63

**Roundabout**

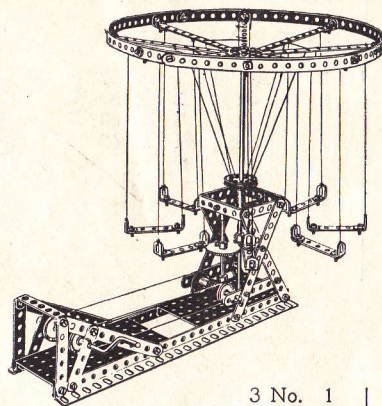

3	No.	1
14	"	2
2	"	3
2	"	4

**Manège**

12	No.	5
2	"	8
24	"	12
3	"	15
1	"	16
1	"	19
1	"	21
4	"	22
2	"	26
1	"	27
1	"	32
68	"	37
12	"	38
2	"	52
4	"	59
4	"	60
1	"	63

**Scarifier  
Scarificateur**

6	No.	2
3	"	3
10	"	5
6	"	12
1	No.	17
1	"	22
22	"	37
2	"	59

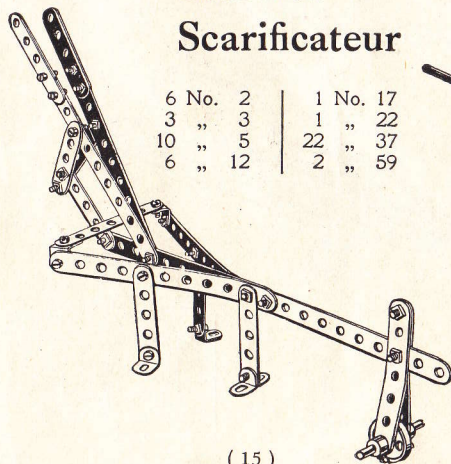

**Field Gun and Carriage  
Canon de Campagne et Caisson**

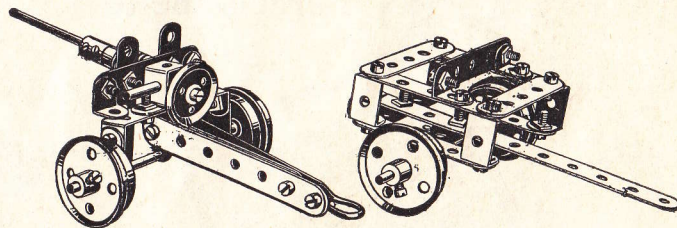

1	No.	2
5	"	3
12	"	5
2	"	10
4	"	11
5	"	12
2	No.	15A
1	"	16
1	"	17
4	"	20
1	"	22
1	"	32
27	No.	37
1	"	45
1	"	57
2	"	59
2	"	60
1	"	63



## Locomotive Crane Grue-Locomotive

2 No. 1	1 No. 21	1 No. 57
2 " 2	1 " 22	2 " 59
2 " 3	1 " 24	5 " 60
3 " 11	1 " 26	1 " 63
2 " 12	1 " 33	
2 " 15A	2 " 35	
1 " 17	38 " 37	
1 " 18	2 " 52	
1 " 19	3 " 53	
4 " 20	1 " 54	

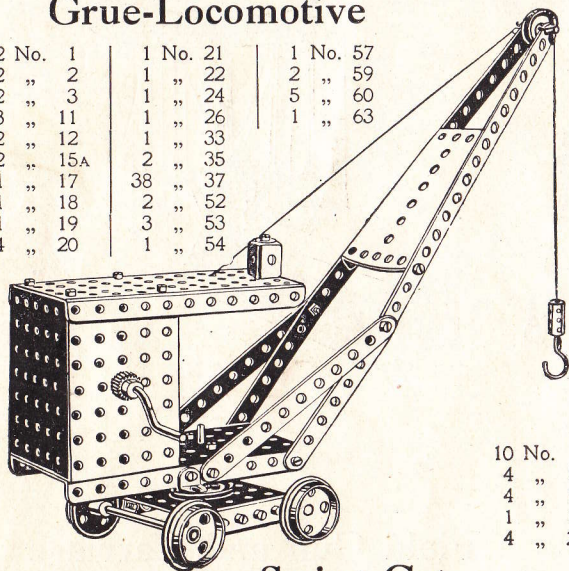

10 No. 2	20 No. 37
4 " 10	1 " 52
4 " 12	2 " 53
1 " 19	2 " 54
4 " 22	

## Oil Cake Chopper Coupe-Tourteau

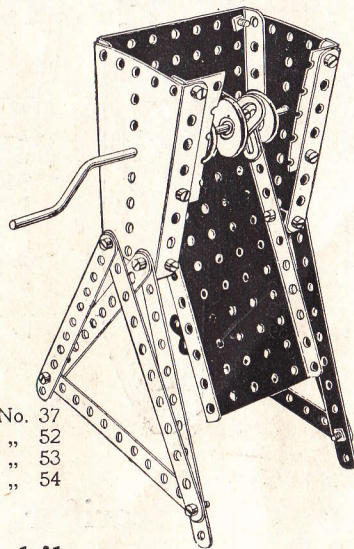

## Swing Cot Bercelonnette

10 No. 1	20 No. 12
14 " 2	2 " 17
2 " 3	2 " 22
8 " 5	62 " 37
2 " 8	2 " 62
2 " 11	

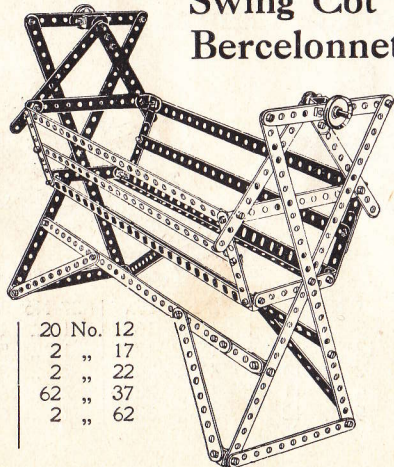

## Automobile

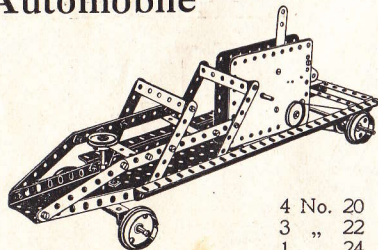

2 No. 2	4 No. 20
6 " 3	3 " 22
2 " 8	1 " 24
4 " 12	1 " 37
2 " 15	38 " 37
2 " 17	1 " 45
	1 " 46
	2 " 52
	1 " 54
	3 " 59
	7 " 60

## Band Saw Scie à Ruban

4 No. 2	2 No. 17
4 " 5	1 " 20A
1 " 8	1 " 21
3 " 11	1 " 22
3 " 12	1 " 26
1 " 16	1 " 27A
	21 " 37
	2 " 52
	2 " 59
	1 " 60

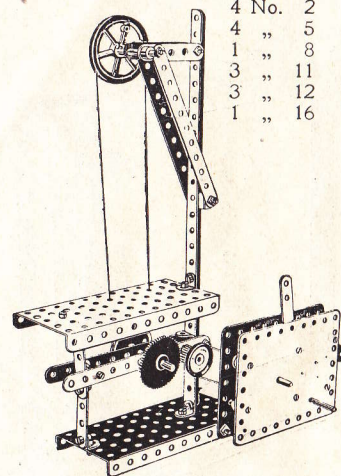

## Rocking Chair

2 No. 1	48 No. 37
13 " 2	2 " 53
8 " 5	3 " 60
2 " 10	
2 " 11	
11 " 12	

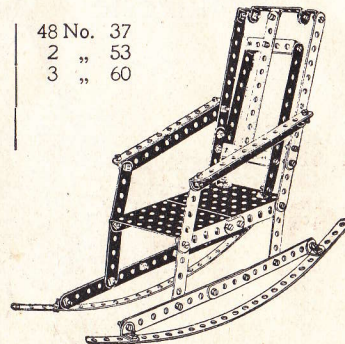



### Swing Balançoire

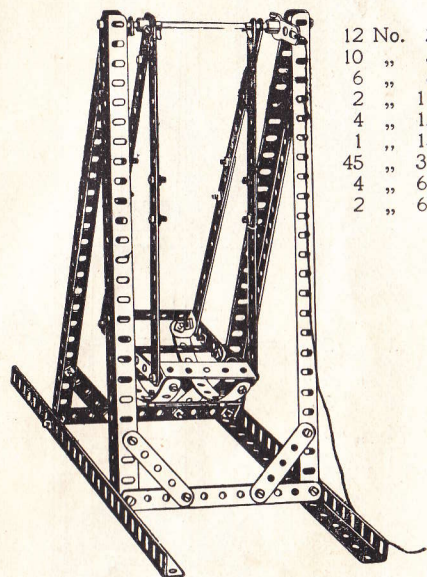

12	No.	2
10	"	5
6	"	8
2	"	11
4	"	12
1	"	15
45	"	37
4	"	60
2	"	62

### Automatic Swing Boat Balançoire Russe

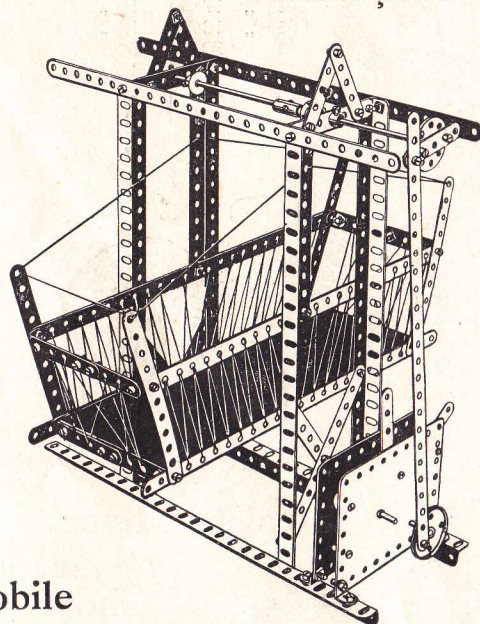

7	No.	1
10	"	2
3	"	3
12	"	5
4	"	8
12	"	12
2	"	15
2	"	21
1	"	24
1	"	37
66	"	59
2	"	62
2	"	63
1	"	

### Swing Balançoire

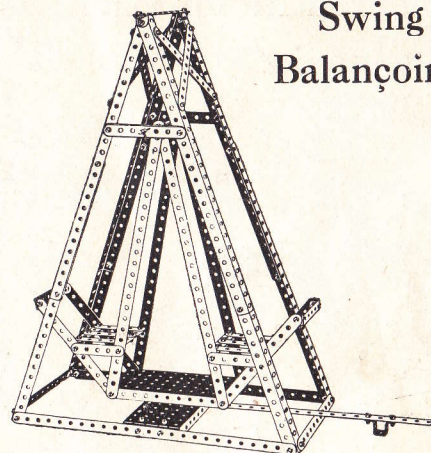

7	No.	1	1	No.	15
11	"	2	6	"	35
2	"	3	67	"	37
10	"	5	1	"	45
8	"	8	2	"	52
6	"	12	6	"	60

### Automobile

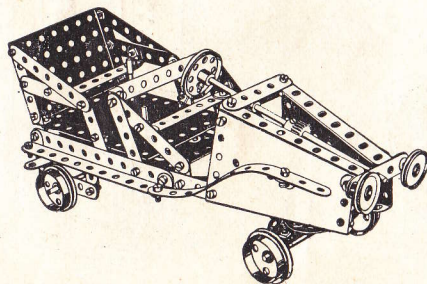

8	No.	2	1	No.	21
5	"	3	2	"	22
4	"	4	1	"	24
9	"	5	2	"	26
6	"	10	1	"	28
28	"	12	1	"	29
1	"	14	17	"	37
1	"	15	1	"	45
1	"	15A	1	"	53
1	"	17	2	"	54
4	"	20	4	"	59
			2	"	60

### Harmonograph Harmonographe

1	No.	2	1	No.	27A
4	"	3	2	"	29
1	"	4	1	"	32
2	"	5	27	"	37
2	"	14	2	"	45
2	"	17	2	"	52
1	"	19	8	"	59
2	"	24	4	"	60
2	"	26			

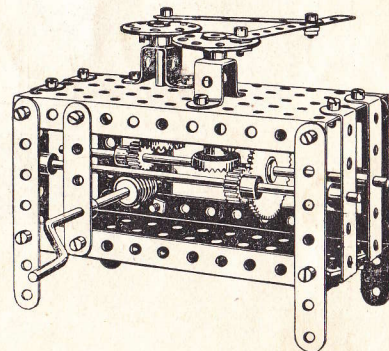



# Armoured Motor Car

Automobile  
Blindée

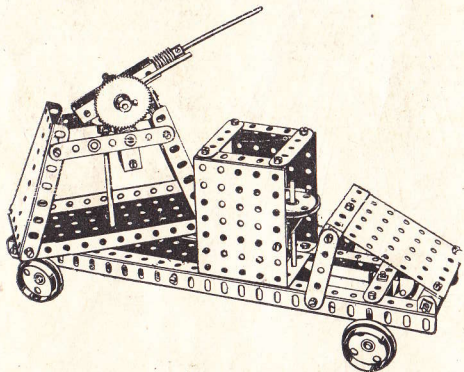

- 2 No. 3
- 9 " 5
- 2 " 8
- 2 " 11
- 2 " 12
- 2 " 15
- 2 " 15A
- 1 " 16
- 3 " 17
- 4 " 20
- 1 " 21
- 4 " 22
- 1 " 24
- 1 " 26
- 1 " 27
- 1 " 32
- 43 " 37
- 1 " 45
- 2 " 52
- 3 " 53
- 2 " 54
- 1 " 59
- 7 " 60
- 1 " 62
- 1 " 63

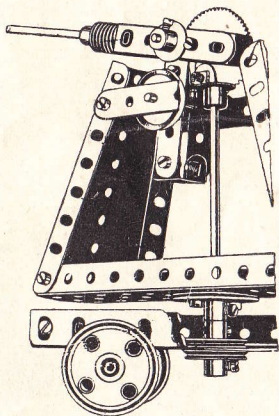

# Armoured Motor Tricycle

Auto  
Tricycle  
Armé

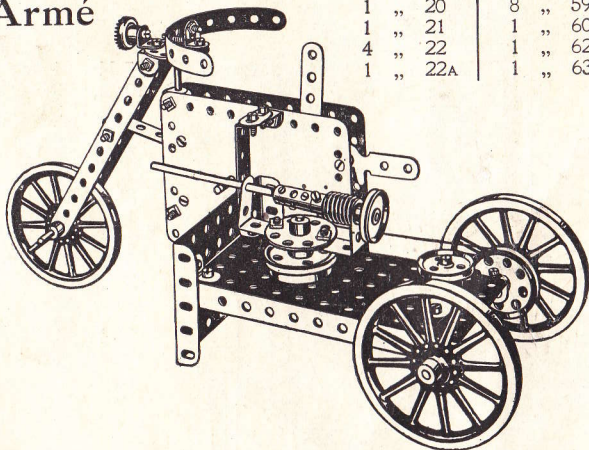

- |         |          |
|---------|----------|
| 4 No. 2 | 2 No. 24 |
| 1 " 5   | 1 " 29   |
| 1 " 10  | 1 " 33   |
| 3 " 11  | 29 " 37  |
| 6 " 12  | 2 " 45   |
| 2 " 15  | 1 " 46   |
| 1 " 17  | 1 " 52   |
| 1 " 18  | 1 " 53   |
| 1 " 20  | 8 " 59   |
| 1 " 21  | 1 " 60   |
| 4 " 22  | 1 " 62   |
| 1 " 22A | 1 " 63   |

# Chocolate Mixer Mélangeur à Chocolat

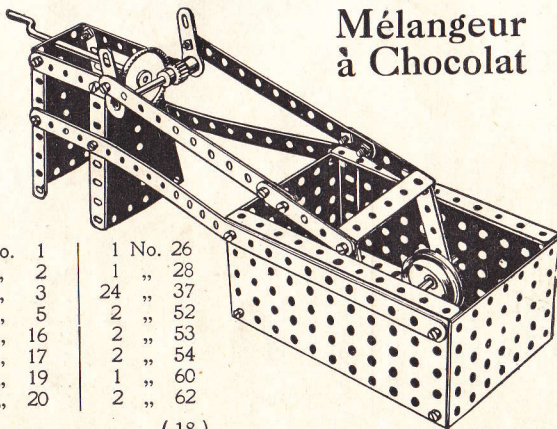

- |         |          |
|---------|----------|
| 2 No. 1 | 1 No. 26 |
| 2 " 2   | 1 " 28   |
| 2 " 3   | 24 " 37  |
| 4 " 5   | 2 " 52   |
| 1 " 16  | 2 " 53   |
| 1 " 17  | 2 " 54   |
| 1 " 19  | 1 " 60   |
| 2 " 20  | 2 " 62   |

# Elevator Ascenseur

- 4 No. 1
- 20 " 2
- 4 " 3
- 2 " 4
- 2 " 5
- 8 " 8
- 9 " 12
- 2 " 14
- 1 " 15
- 2 " 17
- 1 " 19
- 3 " 22
- 1 " 26
- 1 " 27A
- 1 " 33
- 74 " 37
- 1 " 44
- 2 " 52
- 2 " 53
- 5 " 59
- 1 " 63

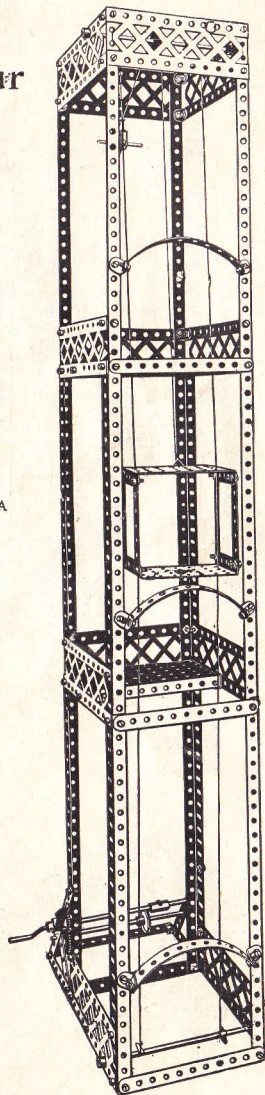



## Clay Modelling Machine

Machine à  
Modeler  
l'Argile

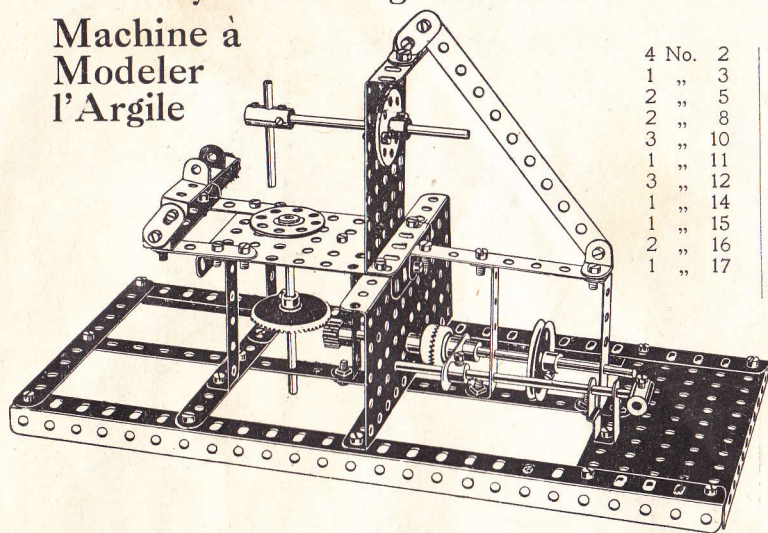

4	No.	2
1	"	3
2	"	5
2	"	8
3	"	10
1	"	11
3	"	12
1	"	14
1	"	15
2	"	16
1	"	17

## Distance Indicator Compteur de Distances

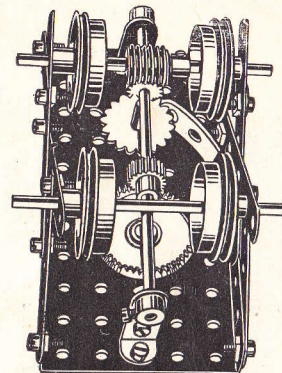
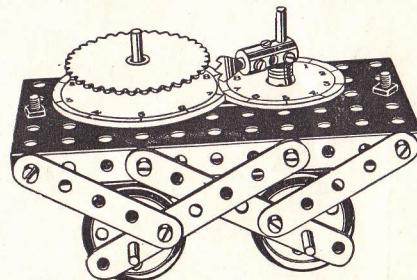

1	No.	21
2	"	24
1	"	26
1	"	28
2	"	29
41	"	37
2	"	52
2	"	53
2	"	59
7	"	60
1	"	62
2	"	63

4	No.	3
1	"	4
4	"	5
2	"	10
2	"	12
1	"	15
2	"	16

4	No.	20
2	"	26
1	"	28
1	"	32
19	"	37
1	"	52
3	"	59

2	No.	62
1	"	63
1	"	65
1	"	95
1	"	96

## Mixing Machine Mélangeoir

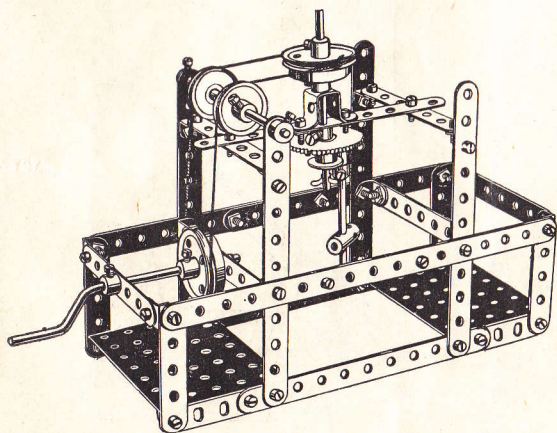

11	No.	2
6	"	3
4	"	5
12	"	12
1	"	15A
2	"	16
1	"	19
2	"	20
2	"	22
1	"	26
1	"	27
43	"	37
1	"	45
2	"	53
3	"	59
2	"	62
2	"	63

## Fire Watertower Tour d'Eau à Incendie

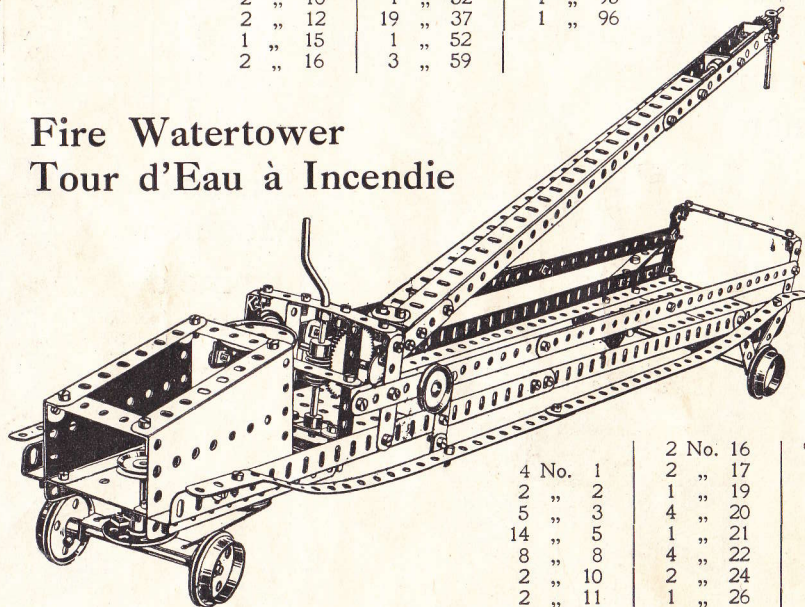

4	No.	1
2	"	2
5	"	3
14	"	5
8	"	8
2	"	10
2	"	11
12	"	12
3	"	15A
2	No.	16
2	"	17
1	"	19
4	"	20
1	"	21
4	"	22
2	"	24
1	"	26
1	"	27A
1	"	32
98	No.	37
1	"	45
1	"	52
3	"	53
2	"	54
5	"	59
3	"	60
2	"	62
1	"	63



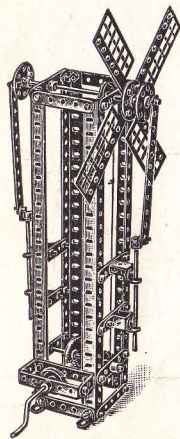

Double-action  
Windmill Pump  
Pompe Double-action  
de Moulin à Vent

2 No.	2	1 No.	24
14 "	5	1 "	26
4 "	8	1 "	28
2 "	11	54 "	37
10 "	12	2 "	45
3 "	15	1 "	46
1 "	16	5 "	59
1 "	19	1 "	60
1 "	21	4 "	61
2 "	22	2 "	62

Treadle Hammer  
Marteau à  
Pédale

14 No.	2
2 "	4
4 "	5
1 "	15
1 "	16
1 "	24
4 "	35
29 "	37
1 "	45
1 "	52
5 "	60
1 "	62
2 "	63

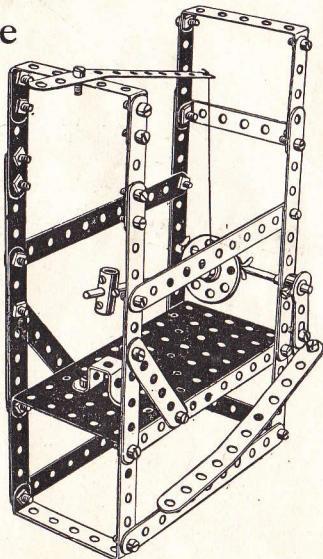

Field Gun  
Canon de  
Campagne

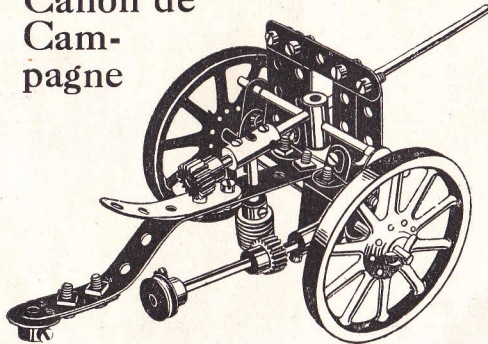

1 No.	2	2 No.	16	17 No.	37
7 "	5	1 "	17	1 "	44
2 "	10	2 "	19A	2 "	59
6 "	12	1 "	23A	1 "	60
1 "	14	2 "	26	1 "	62
1 "	15	1 "	32	2 "	63
		6 "	35		

Drilling  
Machine  
Machine à  
Percer

4 No.	5	2 No.	53
1 "	15	2 "	59
1 "	15A	1 "	62
1 "	17	1 "	63
1 "	21		
2 "	22		
1 "	26		
1 "	28		
13 "	37		
1 "	45		
1 "	46		

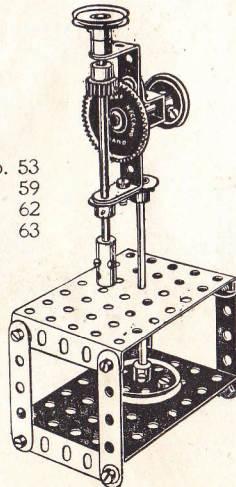

Motor  
Car

Automobile

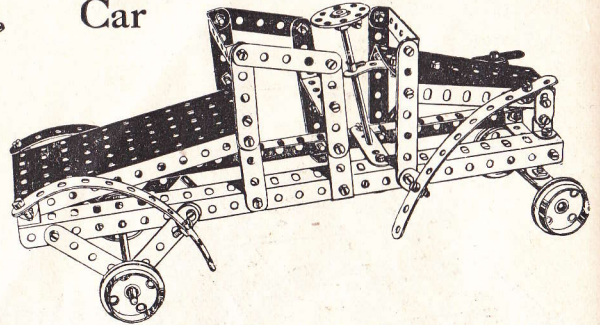

5 No.	2	1 No.	15	55 No.	37
2 "	3	2 "	15A	1 "	45
14 "	5	4 "	20	1 "	52
2 "	8	1 "	24	1 "	54
2 "	10	1 "	35	6 "	60
12 "	12			1 "	62

Catapult

Catapulte

2 No.	1	4 No.	17
5 "	2	1 "	24
6 "	3	1 "	26
4 "	4	1 "	28
12 "	5	1 "	33
4 "	8	84 "	37
2 "	11	1 "	43
12 "	12	2 "	53
1 "	14	4 "	59
1 "	15	2 "	63

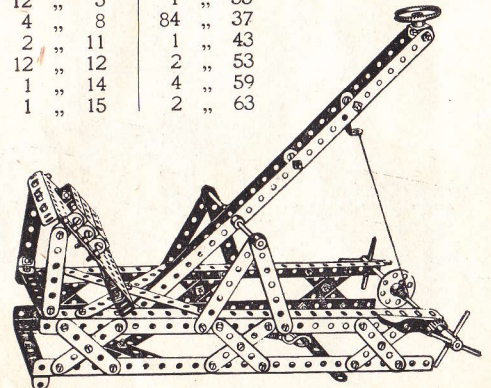



## Mechanical Navyy Excavateur Mécanique

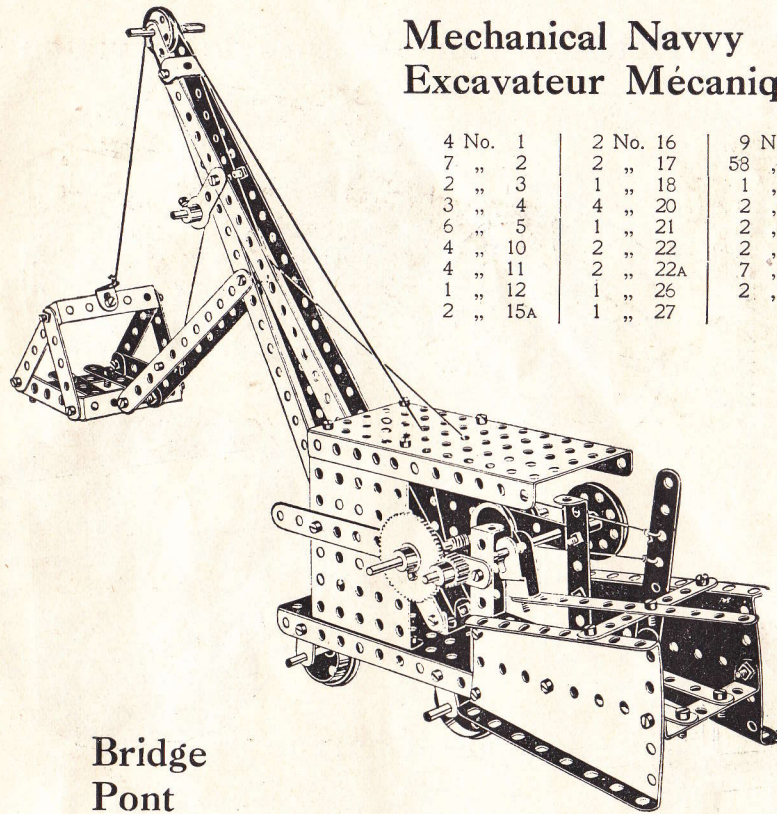

4 No.	1	2 No.	16	9 No.	35
7 "	2	2 "	17	58 "	37
2 "	3	1 "	18	1 "	44
3 "	4	4 "	20	2 "	52
6 "	5	1 "	21	2 "	53
4 "	10	2 "	22	2 "	54
4 "	11	2 "	22A	7 "	60
1 "	12	1 "	26	2 "	62
2 "	15A	1 "	27		

## Bridge Pont

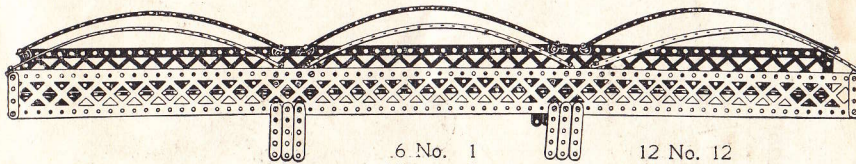

6 No.	1	12 No.	12
12 "	5	44 "	37
4 "	6	4 "	53
6 "	8	6 "	99

## Alternating Swing Balancoire Alternante

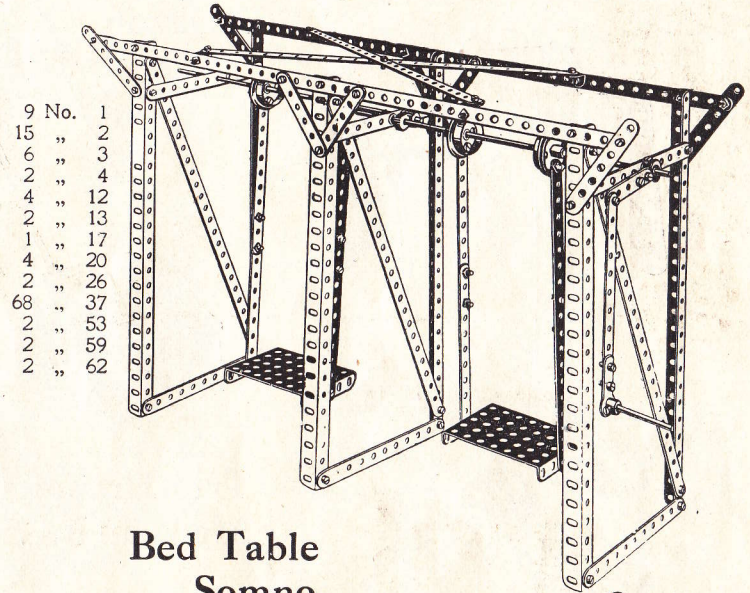

9 No.	1
15 "	2
6 "	3
2 "	4
4 "	12
2 "	13
1 "	17
4 "	20
2 "	26
68 "	37
2 "	53
2 "	59
2 "	62

## Bed Table Somno

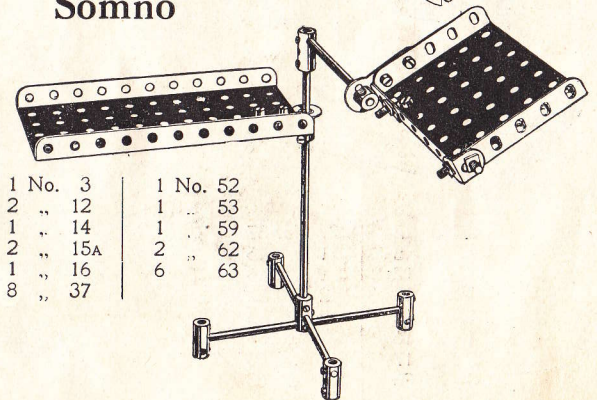

1 No.	3	1 No.	52
2 "	12	1 "	53
1 "	14	1 "	59
2 "	15A	2 "	62
1 "	16	6 "	63
8 "	37		



## Automatic Gong Gong Automatique

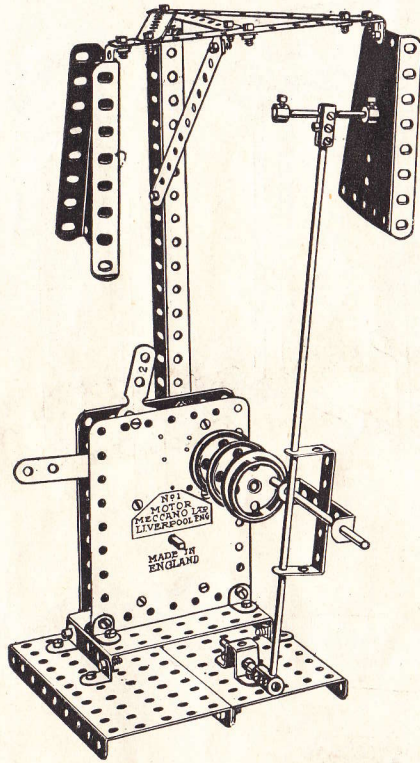

5	No.	2
1	"	8
11	"	12
1	"	13
1	"	15
1	"	16
2	"	17
3	"	20
2	"	35

29	No.	37
1	"	45
1	"	46
2	"	52
2	"	54
3	"	59
1	"	60
2	"	63

## Lawn Mower Tondeuse à Gazon

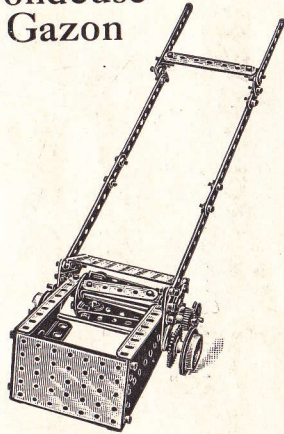

4	No.	2
2	"	3
10	"	5
4	"	10
2	"	12
3	"	15
2	"	20
2	"	22
1	"	23
2	"	24
1	"	26
1	"	27A
1	"	37
50	"	53
3	"	54
2	"	54

## Trip-Hammer Marteau à Cames

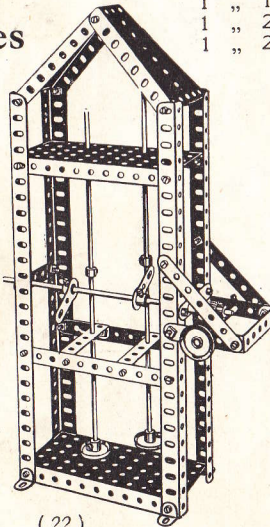

2	No.	2
2	"	3
4	"	5
4	"	8
4	"	12
2	"	13
1	"	14
1	"	16
1	"	17

3	No.	22
1	"	26
1	"	32
32	"	37
2	"	52
2	"	54
4	"	59
3	"	60
2	"	62
1	"	63

## Delivery Van—Voiture de Livraison

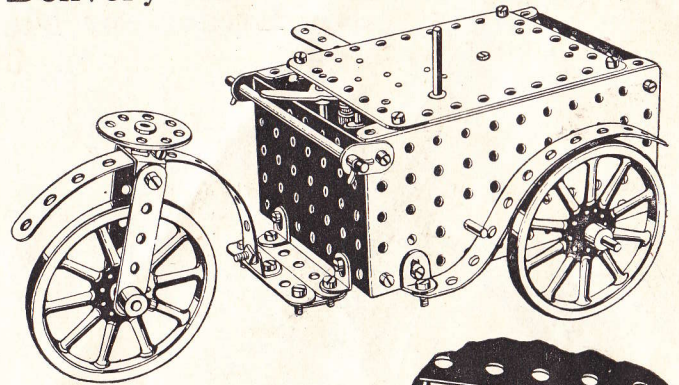

3	No.	2
4	"	5
4	"	10
1	"	11
5	"	12
1	"	15
1	"	15A
1	"	18
1	"	24
1	"	26

1	No.	28
2	"	35
27	"	37
2	"	52
2	"	53
6	"	59
9	"	94
1	"	95
1	"	96

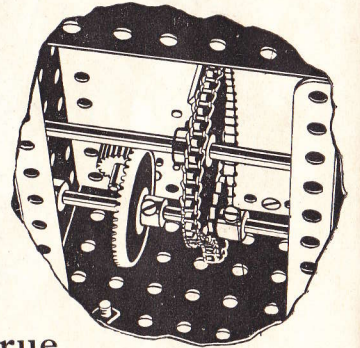

## Plough—Charrue

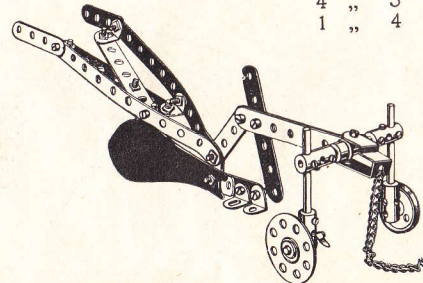

2	No.	2
4	"	3
1	"	4

1	No.	5
4	"	6
6	"	12
2	"	17
1	"	18
1	"	22
1	"	24
15	"	37
1	"	41
1	"	44
2	"	59
4	"	63
3	"	94



**Periscope  
Périscope**

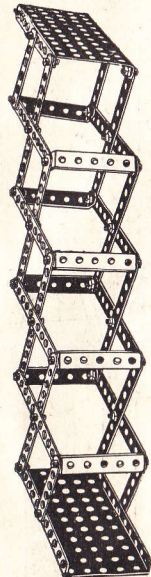

16	No.	2
4	"	4
32	"	37
2	"	52
8	"	60

**Windmill Scare  
Epouvantail de  
Moulin-à Vent**

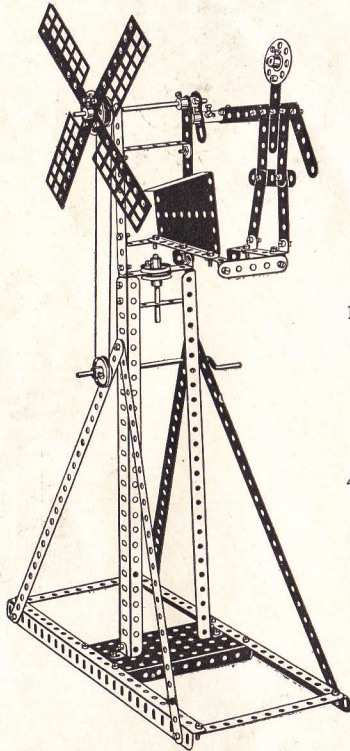

**Wire Rope Maker  
Machine à faire le  
Câble-fil de Fer**

10	No.	2	2	No.	14	2	No.	22A
6	"	3	4	"	15	1	"	24
4	"	4	1	"	16	1	"	26
12	"	5	4	"	17	1	"	27A
4	"	8	4	"	19	80	"	37
8	"	12	8	"	20	2	"	52
1	"	13	4	"	22	7	"	59

**Potato Chopper  
Eplucheuse de  
Pommes Terre**

8	No.	2
2	"	8
4	"	12
4	"	13
2	"	15A
1	"	16
2	"	20
4	"	24
1	"	24
5	"	35
38	"	37
2	"	50
1	"	53
6	"	60
1	"	63

4	No.	1
4	"	2
10	"	5
4	"	8
4	"	12
1	"	15A
2	"	17
1	"	19
4	"	22
2	"	24
2	"	37
49	"	52
1	"	54
1	"	59
4	"	60
4	"	61
4	"	62
1	"	63

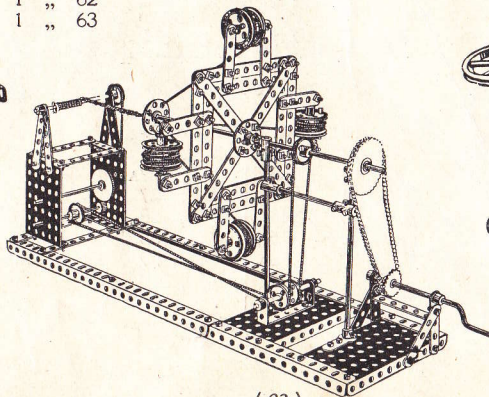
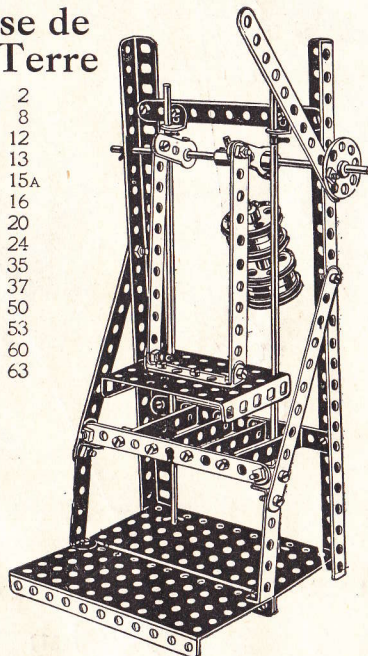

**Swing Saw  
Scie Oscillante**

8	No.	2
1	"	3
12	"	5
6	"	8
1	"	10
1	"	11
4	"	12
1	"	14
2	"	17
1	"	21
45	"	37
2	"	52
8	"	59
2	"	60
1	"	63
1	"	94
1	"	95
2	"	96

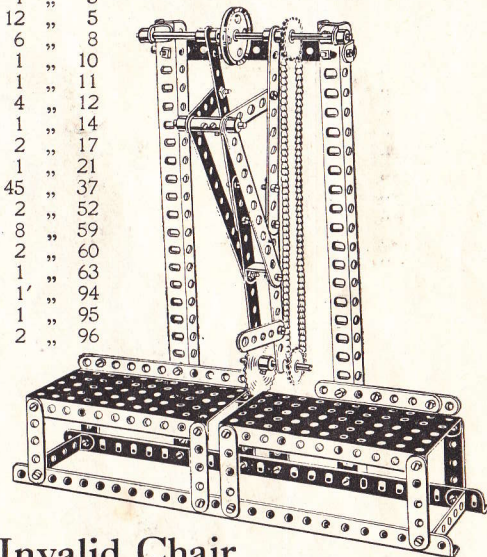

**Invalid Chair  
Voiturette  
de Malade**

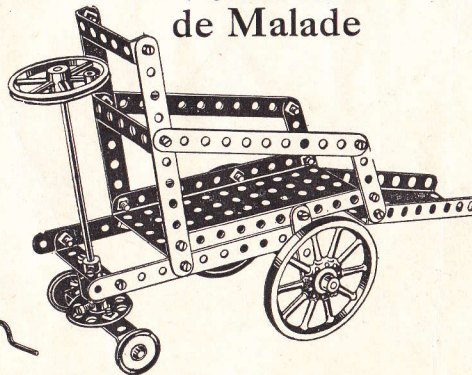

6	No.	2
4	"	5
2	"	15A
1	"	16
2	"	19A
1	"	20A
2	"	22
1	"	24
24	"	37
1	"	46
1	"	52
1	"	54
1	"	59
4	"	60



# Crane—Grue

2 No.	1	54 No.	37
5 "	2	2 "	52
6 "	5	1 "	57
2 "	8	7 "	59
12 "	12	4 "	60
1 "	13	2 "	63
2 "	14	4 "	99
2 "	16	8 "	100
4 "	17		
1 "	18		
8 "	20		
1 "	19A		
2 "	22		
1 "	24		
6 "	35		

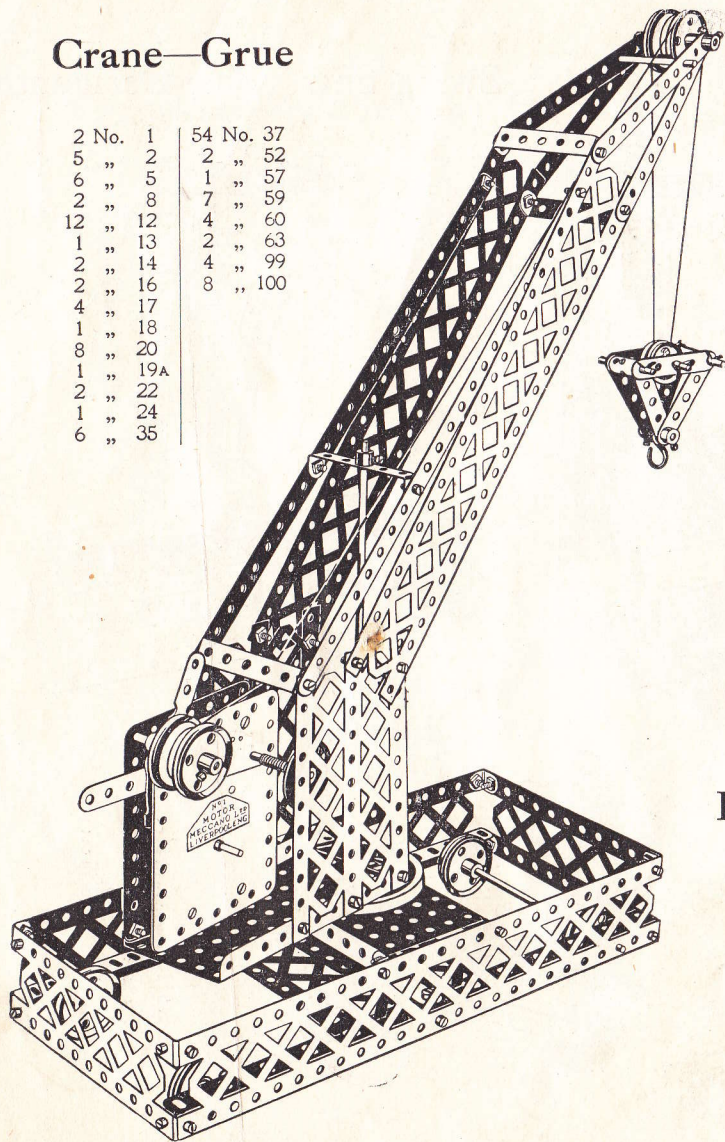

# Printing Machine—Machine à Imprimer

2 No.	1	1 No.	21
9 "	2	2 "	24
10 "	3	2 "	26
2 "	4	1 "	27A
9 "	5	12 "	35
10 "	10	73 "	37
12 "	12	1 "	52
1 "	14	4 "	53
4 "	15	6 "	59
3 "	15A	4 "	60
2 "	16		

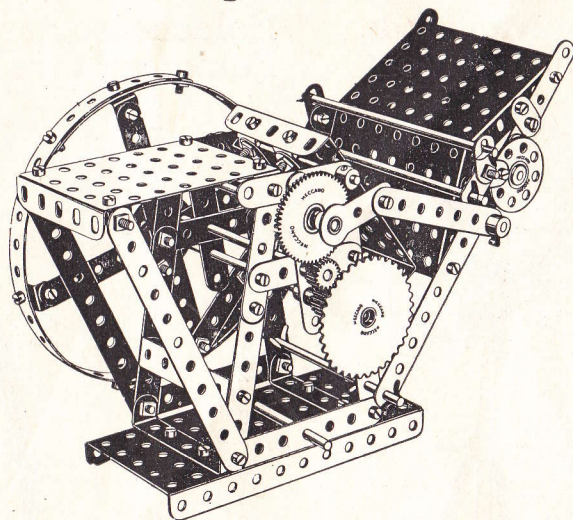

# Belgian Water Wheel

# Roue Hydraulique Belge

10 No.	1	1 No.	24
12 "	2	3 "	26
12 "	5	1 "	27A
4 "	8	82 "	37
28 "	12	2 "	52
2 "	15	2 "	53
1 "	15A	4 "	59
1 "	16	5 "	60
1 "	21	1 "	63

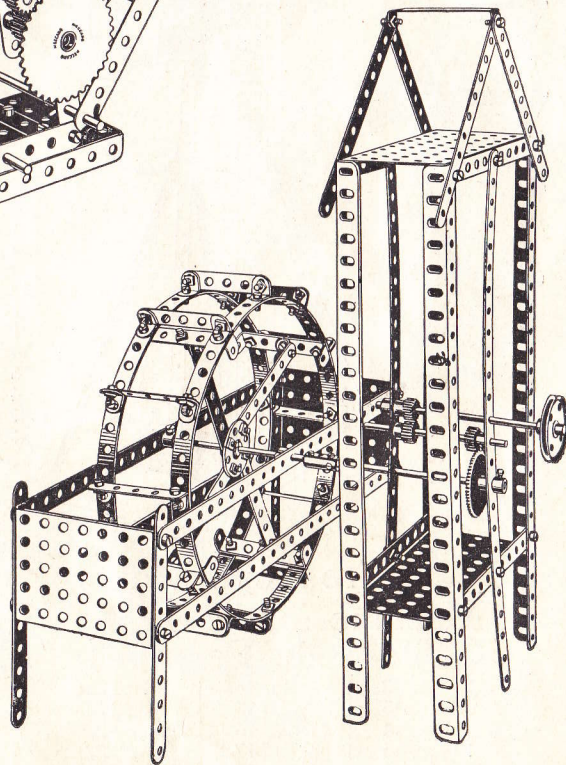



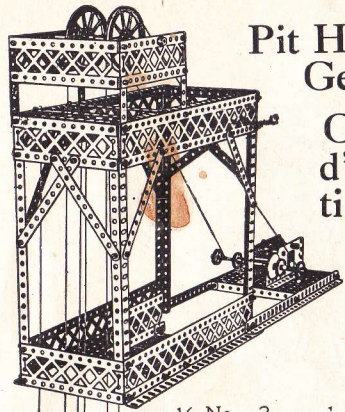

**Pit Head Gear**  
Cage  
d'Extraction de  
Mines

16 No. 2	1 No. 27A
12 " 5	110 " 37
10 " 8	4 " 52
10 " 12	4 " 53
2 " 14	7 " 59
2 " 19A	4 " 99
4 " 22	7 " 100
1 " 26	

**Carpet Sweeper**  
Balai-Brosse à Tapis

6 No. 3	1 No. 26
2 " 10	2 " 27
8 " 12	14 " 37
1 " 13	2 " 53
2 " 15	3 " 59
2 " 15A	2 " 60
4 " 20	2 " 63
2 " 24	

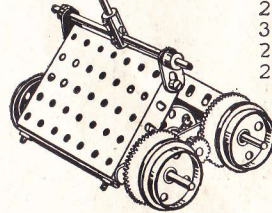

**Timber Carriage**  
Camion pour Bois  
de Charpente

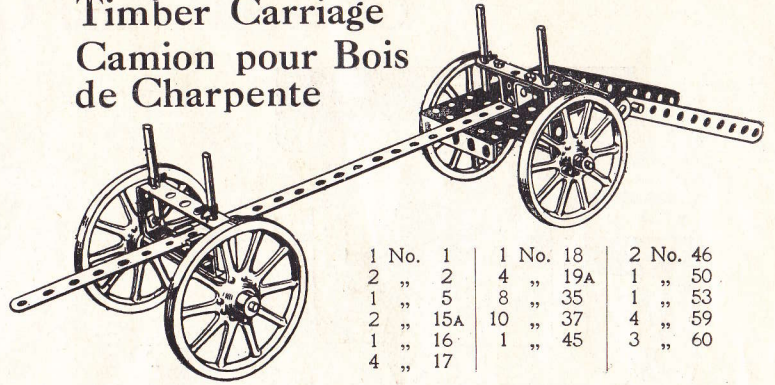

1 No. 1	1 No. 18	2 No. 46
2 " 2	4 " 19A	1 " 50
1 " 5	8 " 35	1 " 53
2 " 15A	10 " 37	4 " 59
1 " 16	1 " 45	3 " 60
4 " 17		

**Delivery Cart**  
Voiture de Livraison

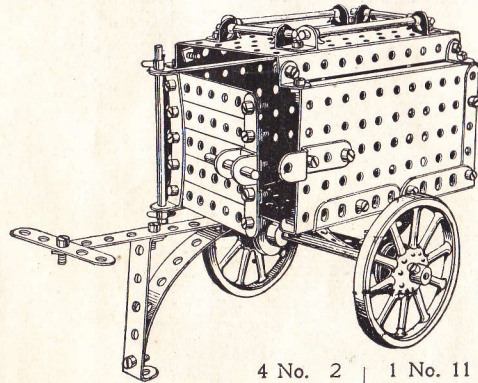

4 No. 2	1 No. 11
5 " 3	12 " 12
3 " 5	1 " 15
2 " 10	3 " 16

**Spooling Machine**  
Bobinoir

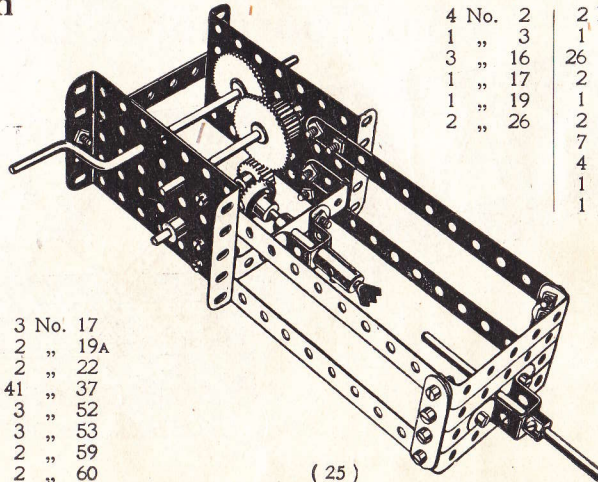

4 No. 2	2 No. 27A
1 " 3	1 " 29
3 " 16	26 " 37
1 " 17	2 " 45
1 " 19	1 " 46
2 " 26	2 " 53
	7 " 59
	4 " 60
	1 " 63
	1 " 65

**Ladder Echelle**

4 No. 1
8 " 2
2 " 3
3 " 5
2 " 10
8 " 12
1 " 16
2 " 17
10 " 35
44 " 37
2 " 59
9 " 60

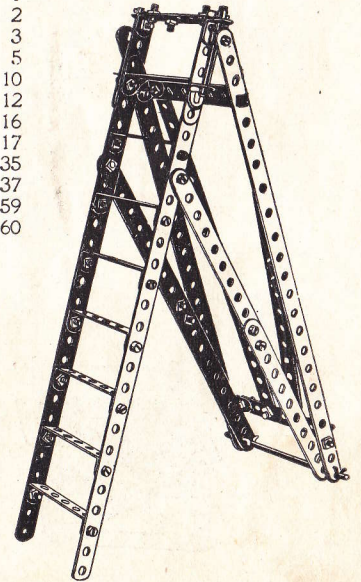



## Caterpillar and Gun—Tracteur et Canon

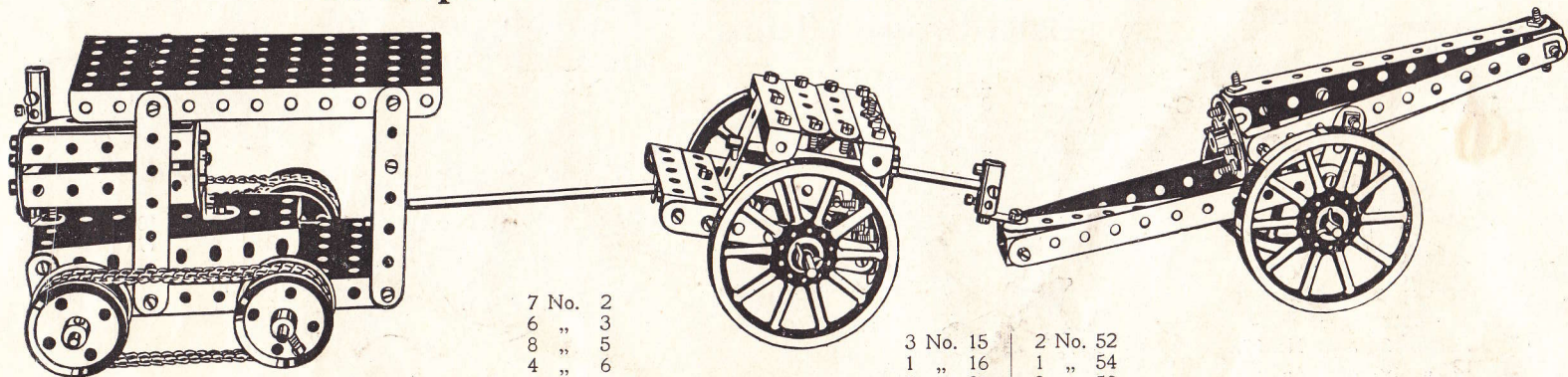

7	No.	2
6	"	3
8	"	5
4	"	6
1	"	10
4	"	11
8	"	12
2	"	14

3	No.	15	2	No.	52
1	"	16	1	"	54
8	"	20	3	"	59
3	"	24	11	"	60
4	"	35	2	"	63
78	"	37	4	"	94

## Rolling Lift Bridge Pont Tournant et Basculant

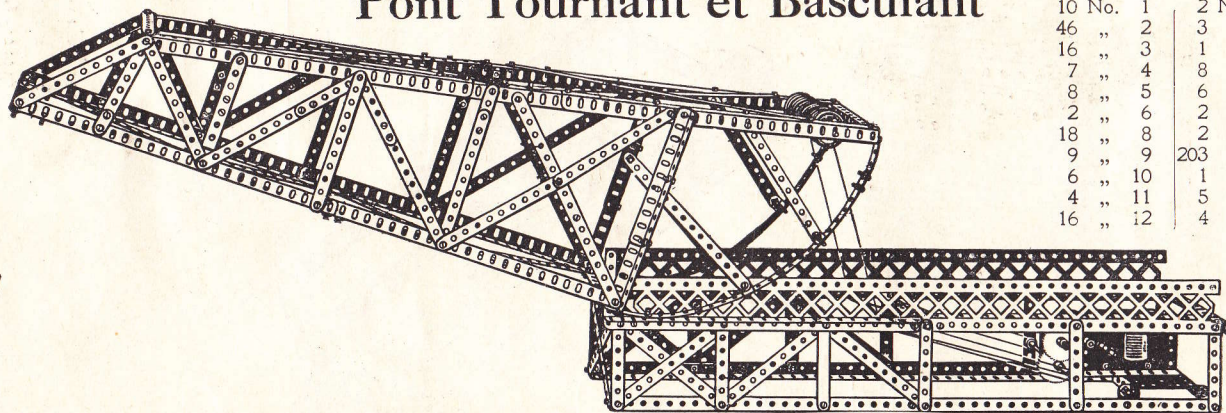

10	No.	1	2	No.	13
46	"	2	3	"	14
16	"	3	1	"	17
7	"	4	8	"	20
8	"	5	6	"	23
2	"	6	2	"	26
18	"	8	2	"	27
9	"	9	203	"	37
6	"	10	1	"	52
4	"	11	5	"	59
16	"	12	4	"	99



# Beam Engine

Machine  
à Vapeur  
à Balancier

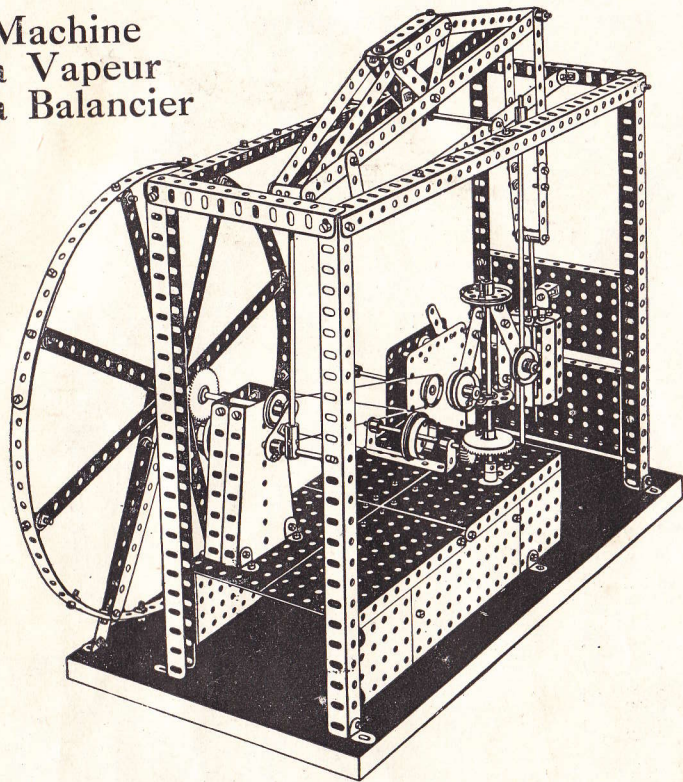

7 No.	1	27 No.	12	2 No.	21	1 No.	50
18 "	2	1 "	13	5 "	22	7 "	52
3 "	4	1 "	13A	2 "	23	4 "	53
10 "	5	1 "	14	4 "	24	2 "	54
1 "	6	3 "	15	2 "	26	7 "	59
8 "	8	1 "	16	1 "	27	6 "	60
4 "	9	2 "	17	1 "	28	3 "	62
6 "	10	2 "	18	149 "	37	5 "	63
4 "	11	2 "	20	1 "	46		

# Joy Wheel

Assiette au  
Beurre

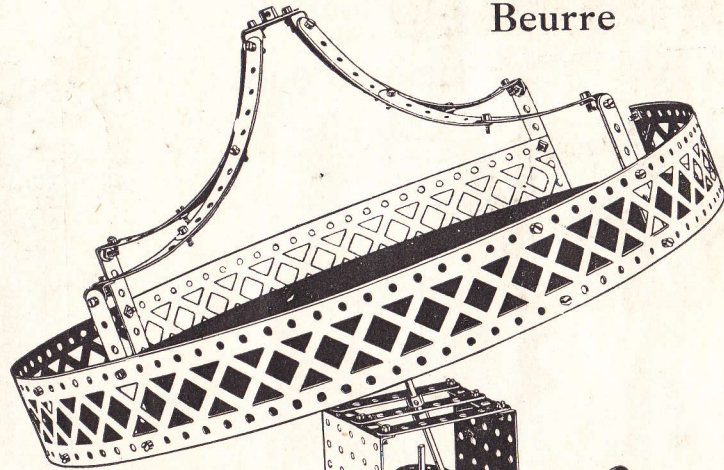

4 No.	1
23 "	2
15 "	3
4 "	4
3 "	5
1 "	6
4 "	8
10 "	12
1 "	14
1 "	15
1 "	15A
1 "	19
3 "	24
1 "	26
2 "	27
1 "	32
121 "	37
2 "	52
6 "	53
8 "	59
7 "	60
4 "	99

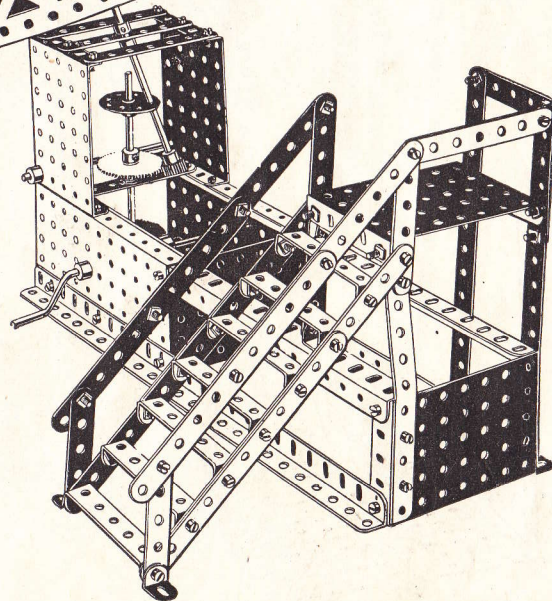



Purchase  
Block

Palan à Poulies  
Mouffées

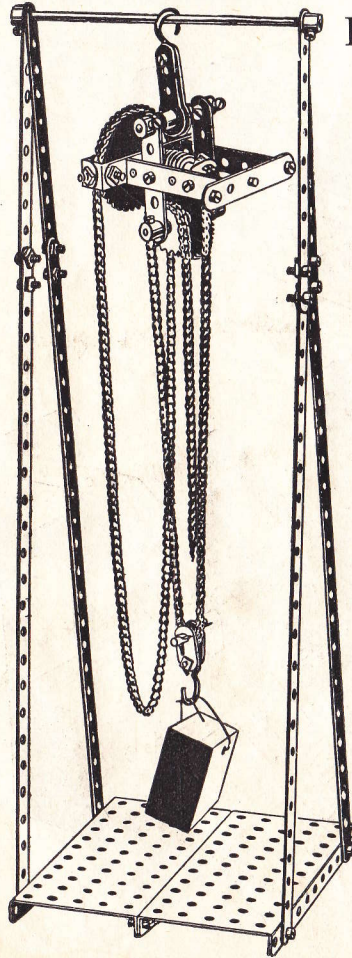

- 4 No. 1
- 4 " 2
- 3 " 5
- 2 " 10
- 1 " 12
- 1 " 15
- 1 " 16
- 2 " 17
- 1 " 18
- 1 " 27A
- 1 " 32
- 2 " 35
- 23 " 37
- 2 " 52
- 2 " 57
- 7 " 59
- 4 " 60
- 2 " 62
- 4' " 94
- 1 " 95
- 1 " 96

Semaphore  
Sémaphore

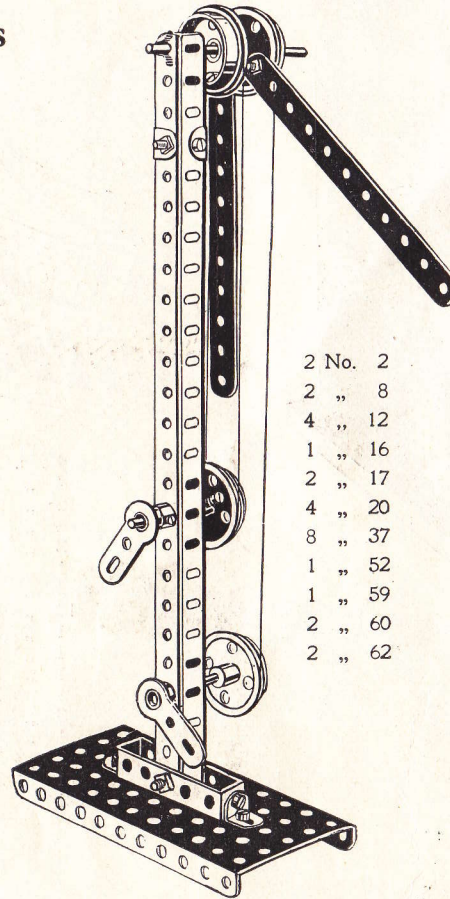

- 2 No. 2
- 2 " 8
- 4 " 12
- 1 " 16
- 2 " 17
- 4 " 20
- 8 " 37
- 1 " 52
- 1 " 59
- 2 " 60
- 2 " 62

Catapult  
Catapulte

- 2 No. 1
- 21 " 2
- 12 " 3
- 2 " 4
- 4 " 5
- 1 " 6
- 4 " 8
- 8 " 11
- 19 " 12
- 3 " 14
- 1 " 16
- 4 " 35
- 98 " 37
- 1 " 43
- 8 " 59
- 4 " 60

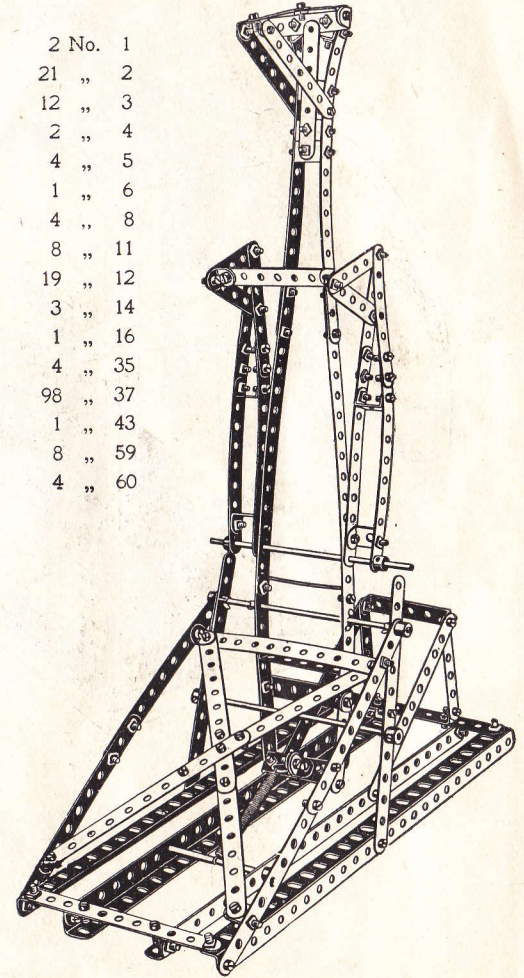



# Equatorial Mounting Equatorial

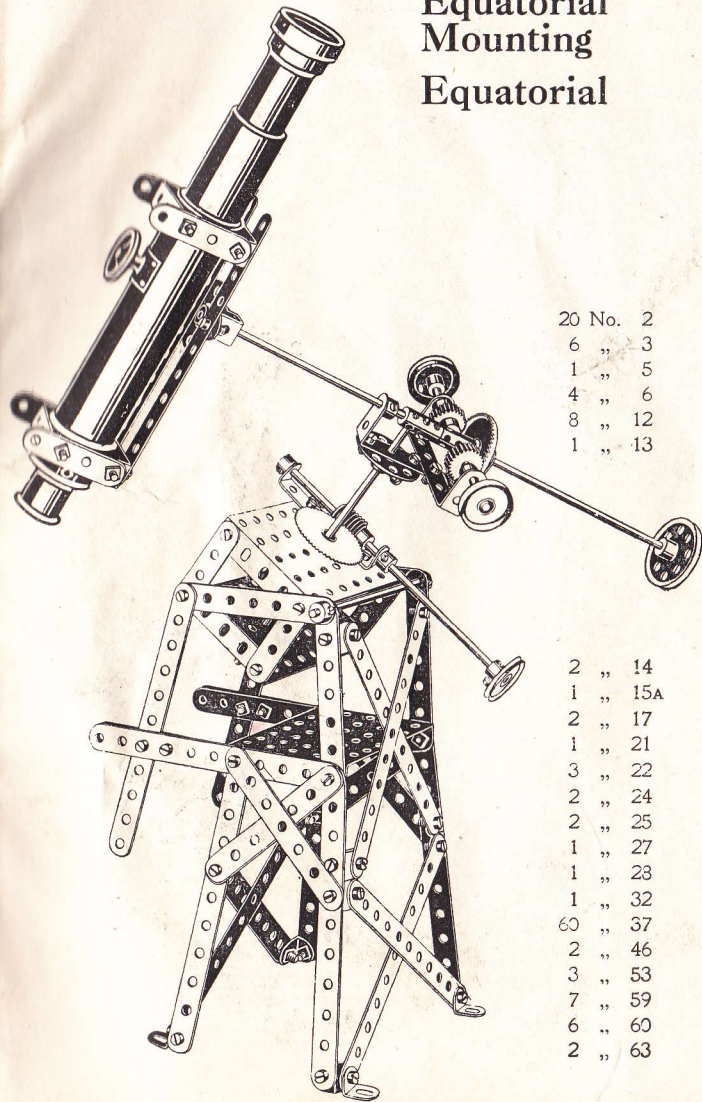

- 20 No. 2
- 6 " 3
- 1 " 5
- 4 " 6
- 8 " 12
- 1 " 13

- 2 " 14
- 1 " 15A
- 2 " 17
- 1 " 21
- 3 " 22
- 2 " 24
- 2 " 25
- 1 " 27
- 1 " 28
- 1 " 32
- 60 " 37
- 2 " 46
- 3 " 53
- 7 " 59
- 6 " 60
- 2 " 63

# Theatre Théâtre

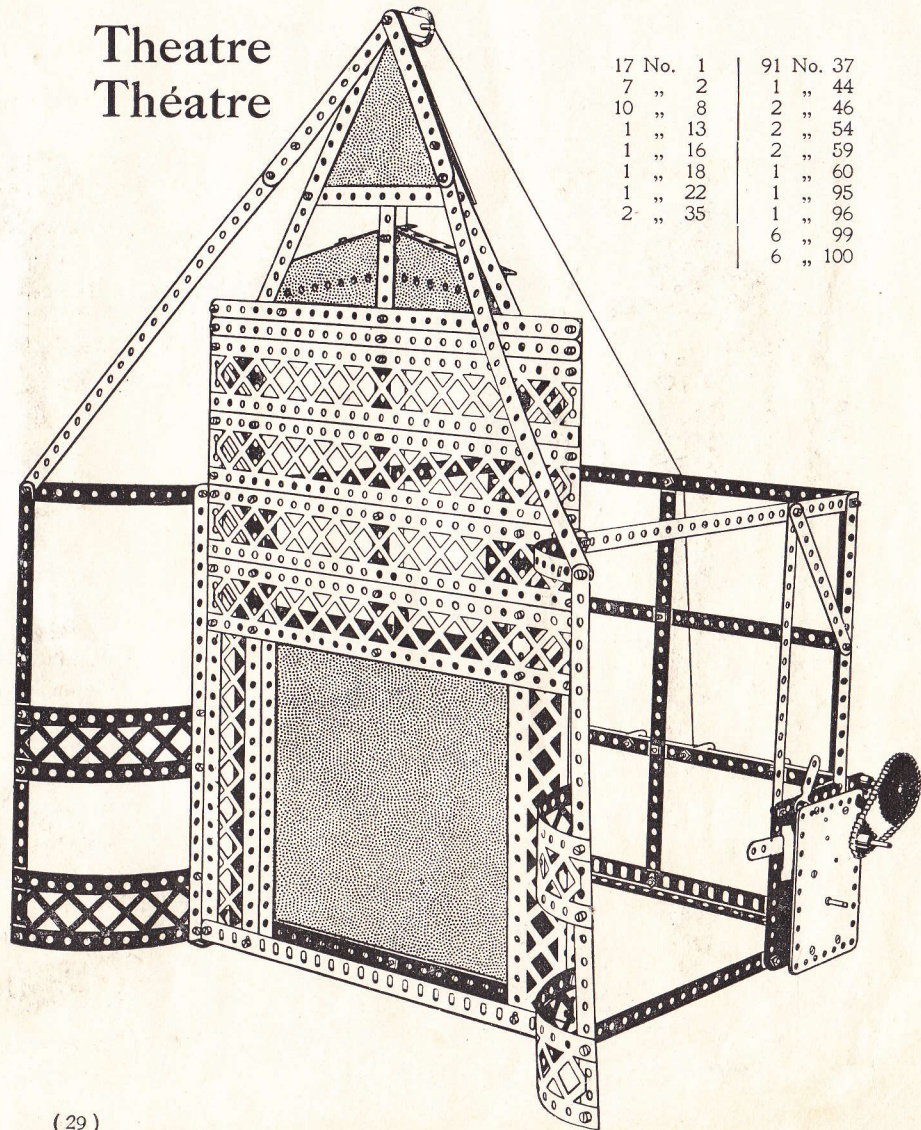

- |          |           |
|----------|-----------|
| 17 No. 1 | 91 No. 37 |
| 7 " 2    | 1 " 44    |
| 10 " 8   | 2 " 46    |
| 1 " 13   | 2 " 54    |
| 1 " 16   | 2 " 59    |
| 1 " 18   | 1 " 60    |
| 1 " 22   | 1 " 95    |
| 2 " 35   | 1 " 96    |
|          | 6 " 99    |
|          | 6 " 100   |



## Dental Chair Chaise de Dentiste

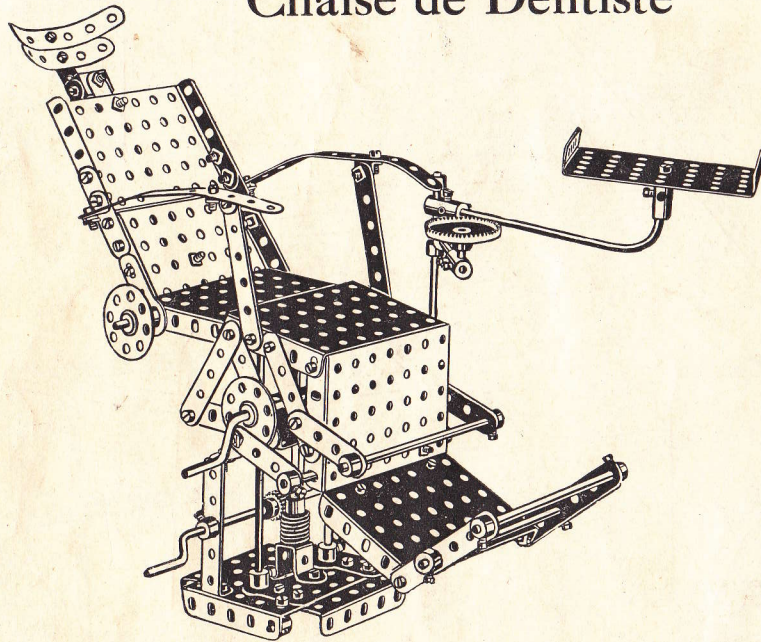

3 No. 2	1 No. 14	63 No. 37
2 " 3	3 " 15	1 " 45
4 " 4	5 " 15A	2 " 50
7 " 5	1 " 16	10 " 53
6 " 6	2 " 19	17 " 59
2 " 11	2 " 24	2 " 60
6 " 12	1 " 26	3 " 62
1 " 13A	1 " 28	4 " 63
	1 " 32	

## Loom—Métier à Tisser

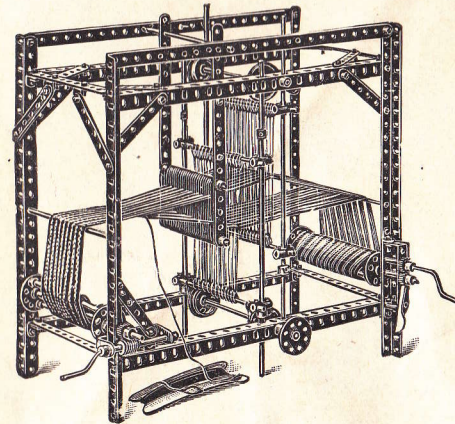

2 No. 1	2 No. 19
4 " 2	4 " 20
2 " 3	4 " 22
13 " 4	5 " 24
48 " 5	3 " 26
8 " 8	1 " 32
2 " 9	1 " 33
1 " 10	16 " 35
3 " 12	64 " 37
4 " 13	2 " 46
2 " 13A	2 " 52
8 " 14	12 " 59
4 " 15	8 " 63
2 " 15A	

## Roller Skate Patin à Roulettes

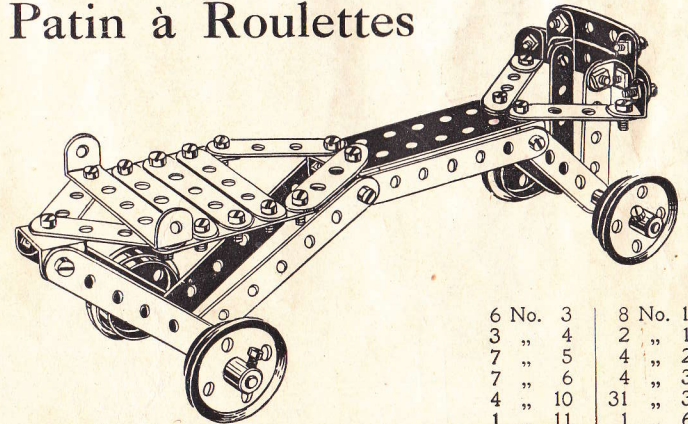

6 No. 3	8 No. 12
3 " 4	2 " 16
7 " 5	4 " 20
7 " 6	4 " 35
4 " 10	31 " 37
1 " 11	1 " 60



# Steam Shovel Pelle à Vapeur

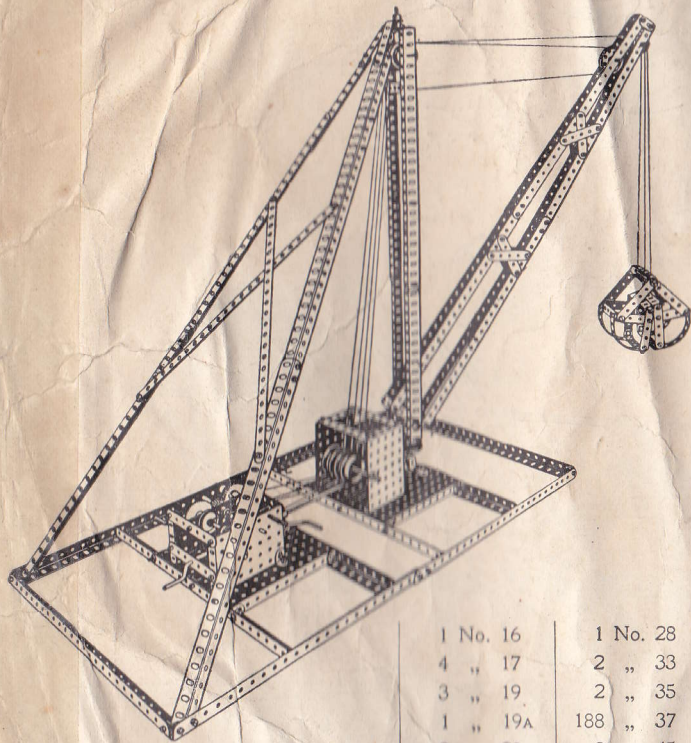

- 10 No. 1
- 12 " 3
- 4 " 4
- 16 " 5
- 4 " 6

- 18 No. 8
- 2 " 9
- 3 " 10
- 2 " 11
- 28 " 12
- 1 " 13

- 1 No. 16
- 4 " 17
- 3 " 19
- 1 " 19A
- 8 " 20
- 1 " 21
- 2 " 22
- 3 " 22A
- 2 " 24
- 4 " 26
- 2 " 27

- 1 No. 28
- 2 " 33
- 2 " 35
- 188 " 37
- 2 " 45
- 3 " 46
- 4 " 52
- 4 " 53
- 11 " 59
- 6 " 60
- 1 " 63

# Fret Saw

# Scie à découper

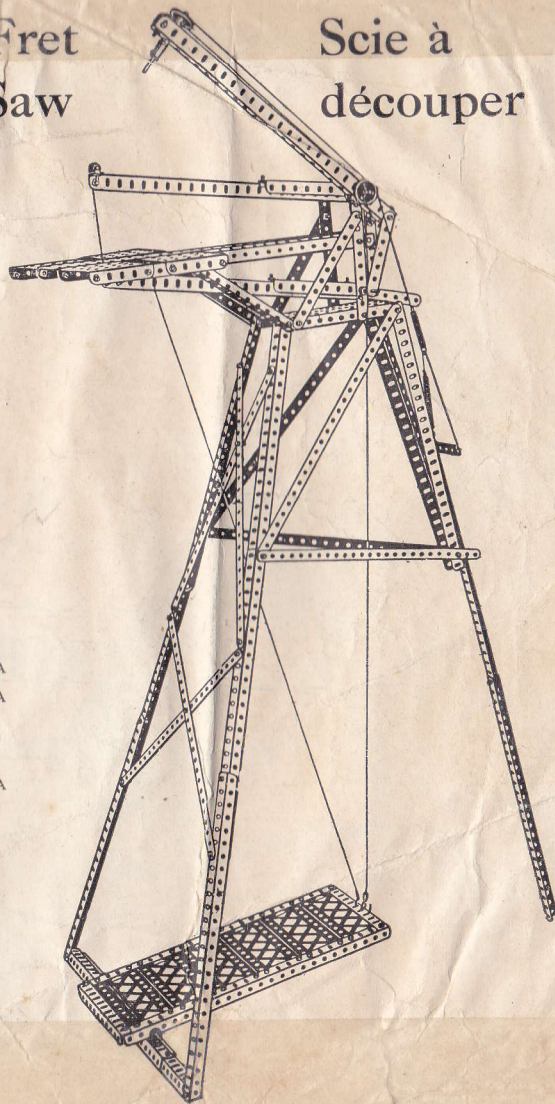

- 8 No. 1
- 6 " 2
- 3 " 3
- 1 " 4
- 1 " 5
- 20 " 8
- 4 " 9
- 2 " 10
- 3 " 12
- 1 " 13A
- 2 " 15A
- 1 " 16
- 1 " 22
- 2 " 22A
- 98 " 37
- 2 " 43
- 2 " 52
- 4 " 53
- 2 " 54
- 2 " 57
- 4 " 59
- 1 " 63
- 6 " 100



# Helter Skelter Toboggan Colimaçon

21 No.	1
7 "	2
15 "	5
8 "	8
6 "	9
2 "	10
4 "	12
157 "	37
2 "	52
4 "	53
2 "	54
9 "	60
10 "	99
2 "	100

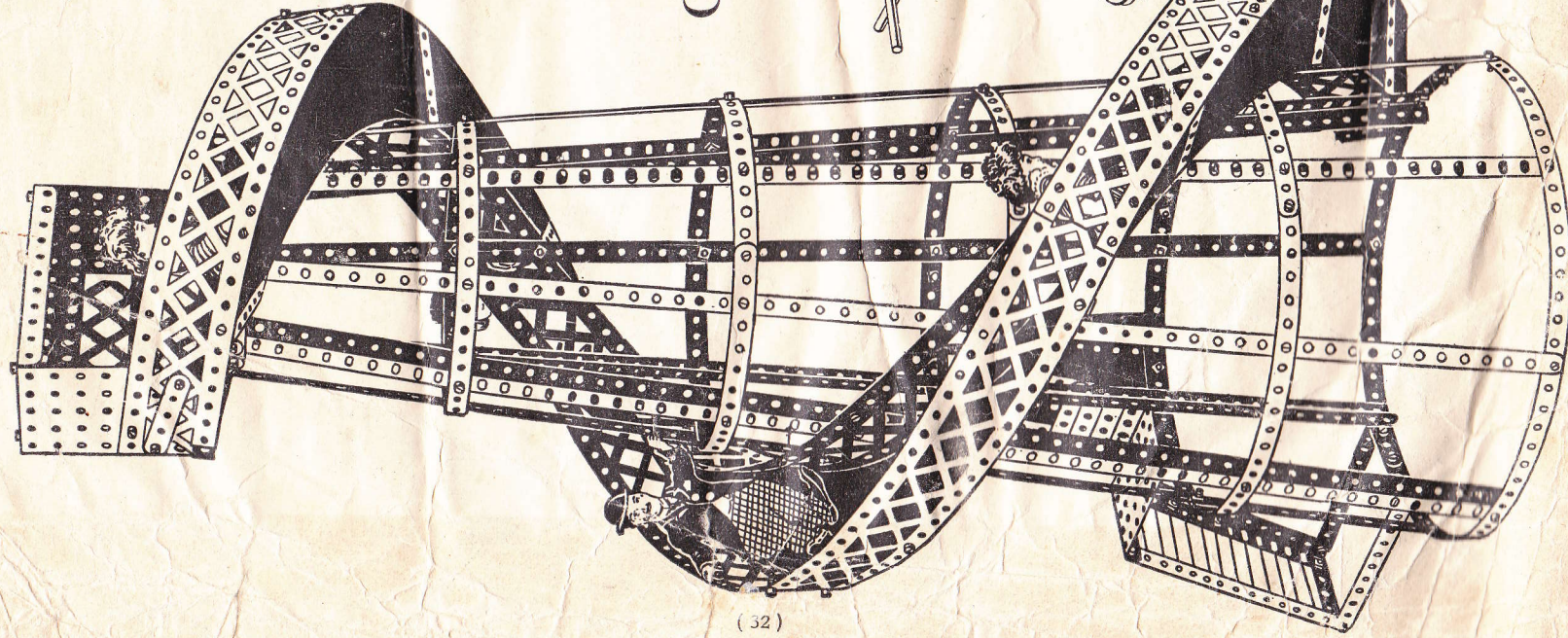

# Jaunting Car Charrette Irlandaise

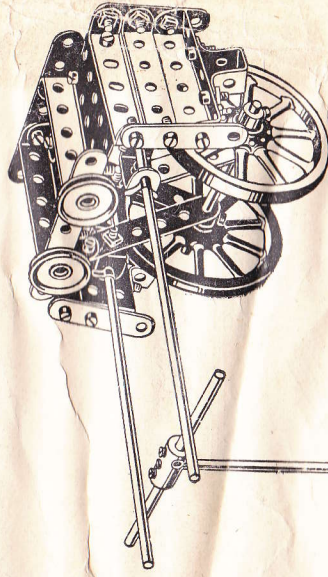

2 No.	3
4 "	4
4 "	6
14 "	12
2 "	13A
1 "	15
1 "	16
2 "	17
2 "	19A

1 No.	20
2 "	22
4 "	35
40 "	37
2 "	45
1 "	53
4 "	59
8 "	60
1 "	63