

Instructions  
Notice de montage  
Bauanleitung  
Istruzioni di montaggio  
Instrucciones de montaje  
Instruções de montagem  
Monteringsanvisning  
Kokoamisohje  
Monterings instruktioner  
Montagehandleiding

Οδηγίες συναρμολόγησης.  
組立説明書

# DESIGN 4

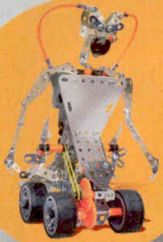
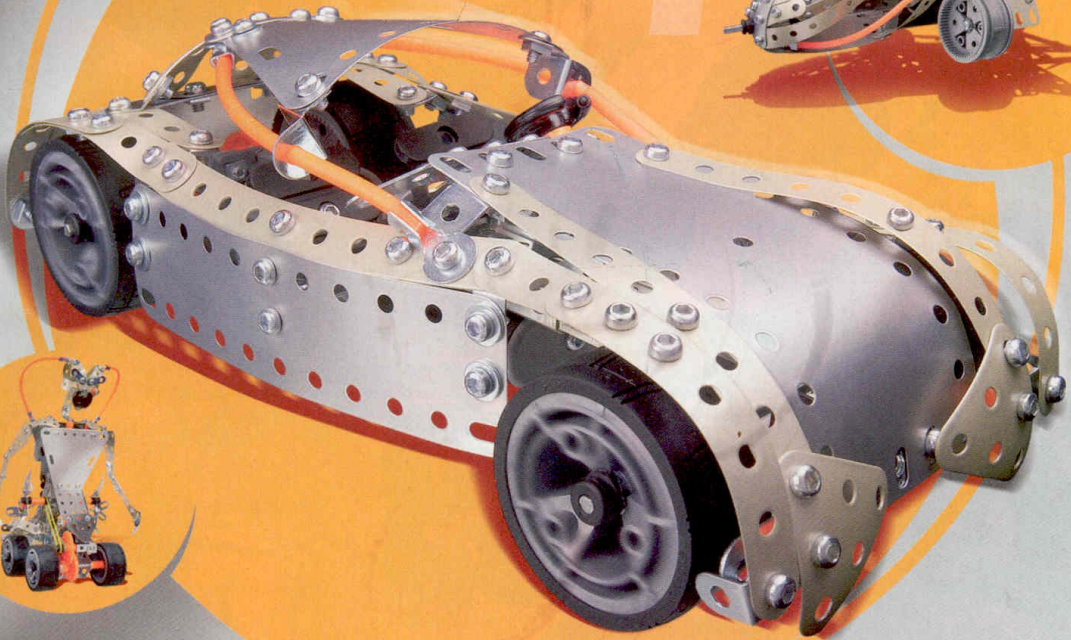

#7700

\* 8-15



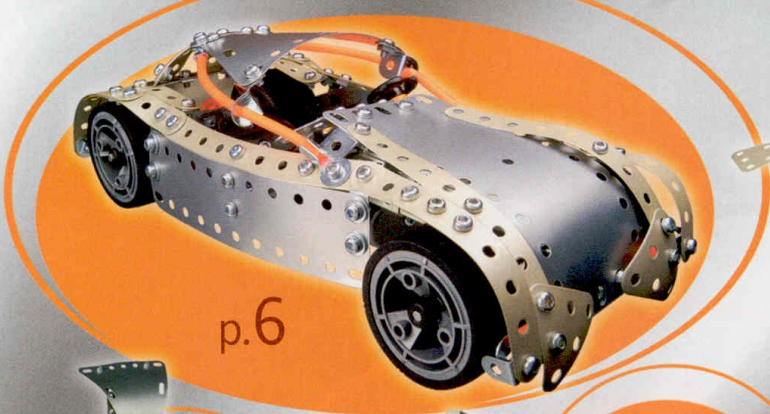

p.6



p.14



p.21



p.31

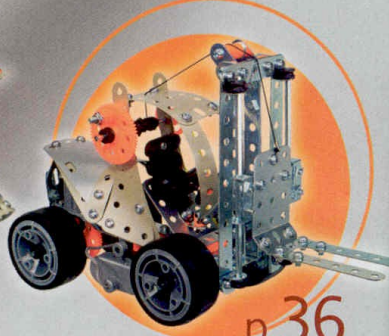

p.36



p.26



p.52

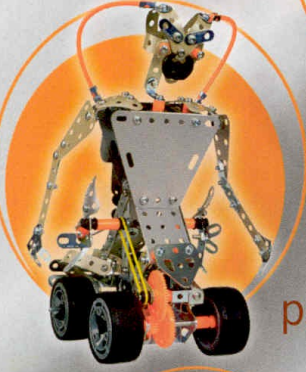

p.41

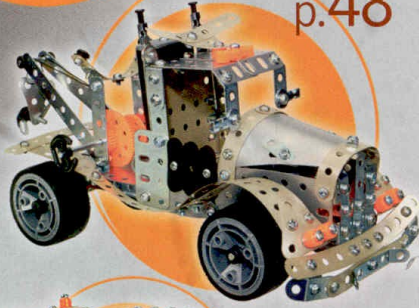

p.48

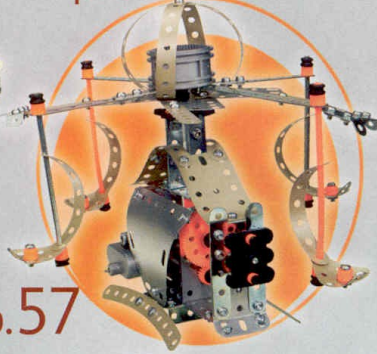

p.57

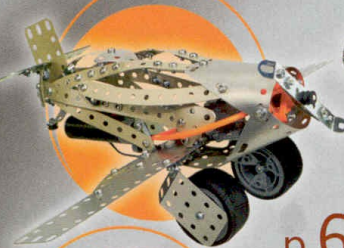

p.62

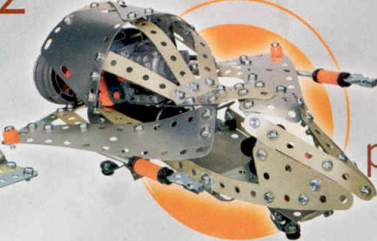
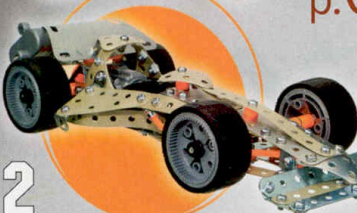
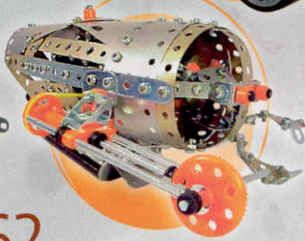

p.63

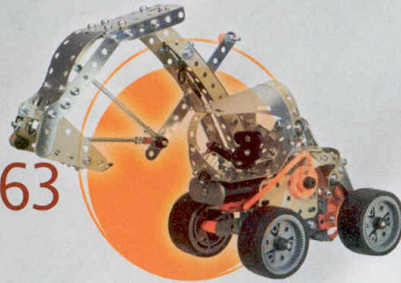

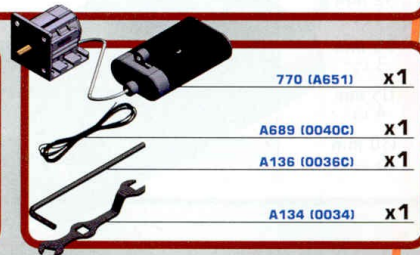
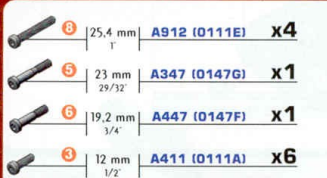
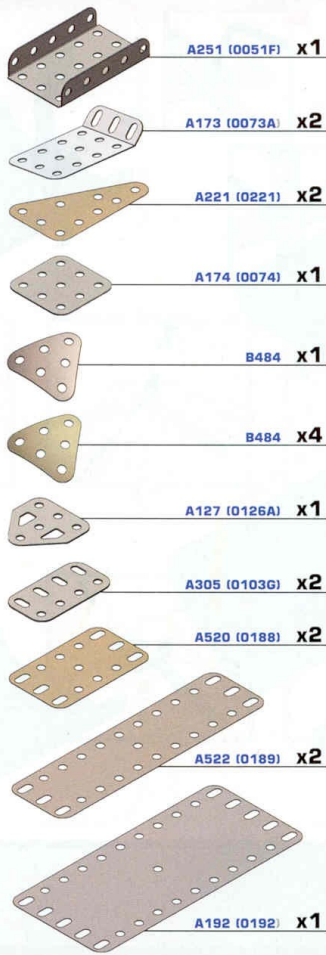
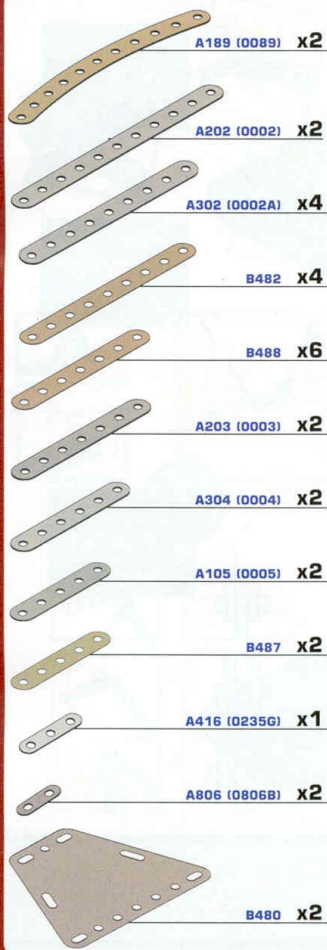

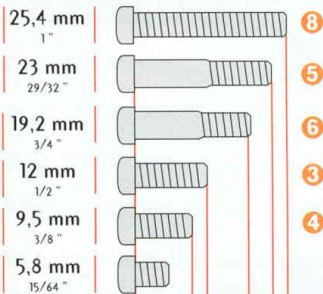
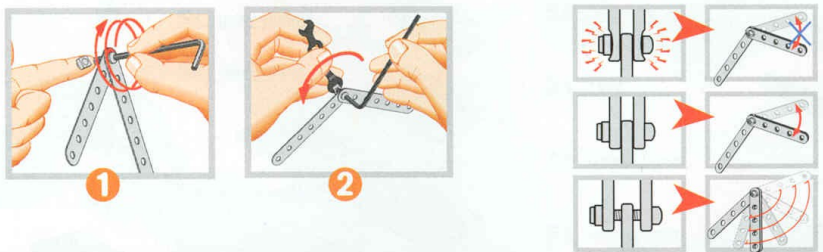
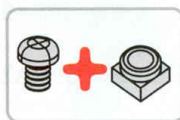
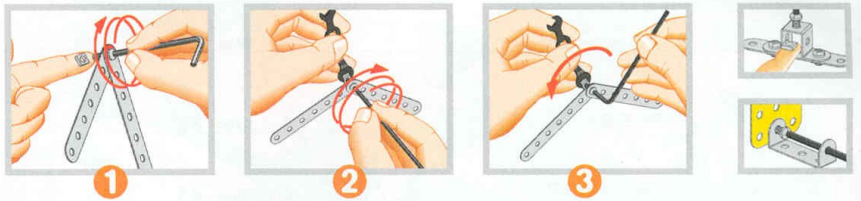
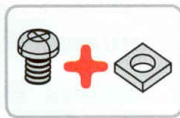
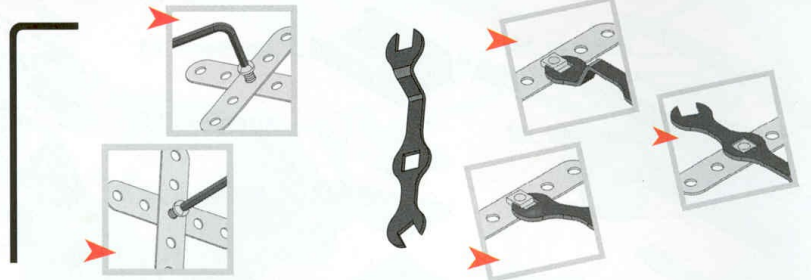

Scale  
Échelle  
Maßstab  
Scala

Escala  
Schaal  
Escala  
Skala

Mittakaava  
Målestok  
Κλίμακα  
スケール

1:1

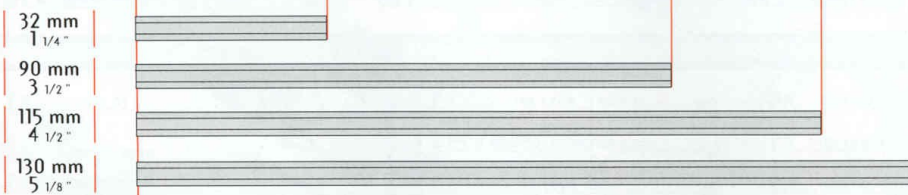

1

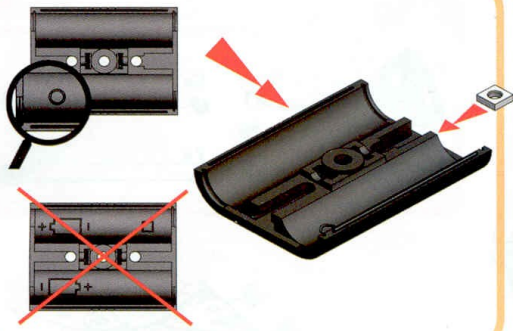

2

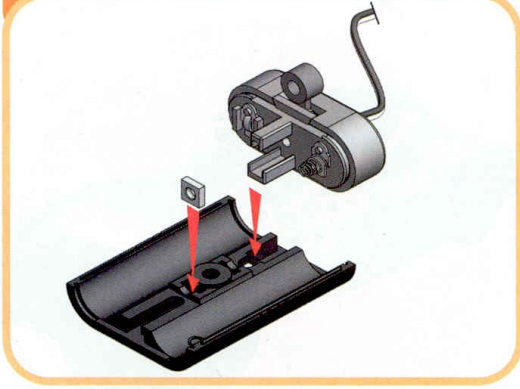

3

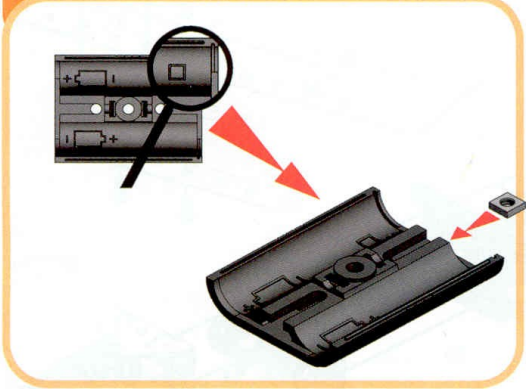

4

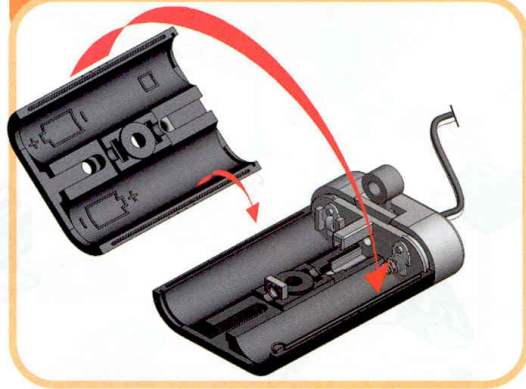

5

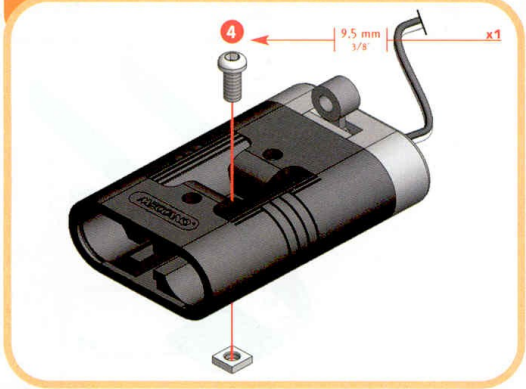

6



7

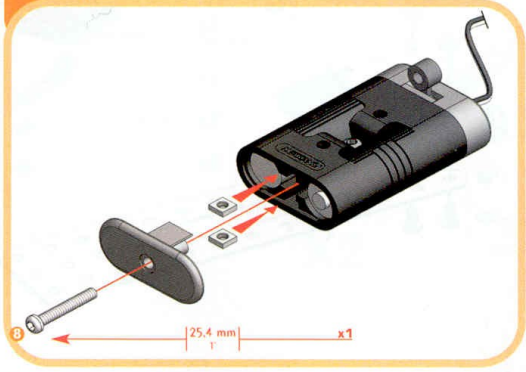

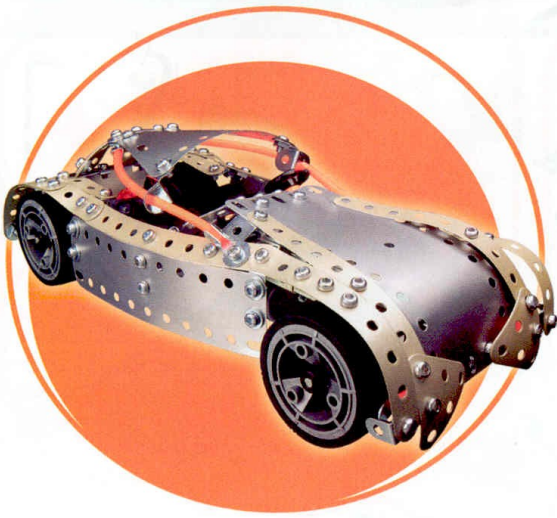

**1**

	x1		x2
	x2		x2

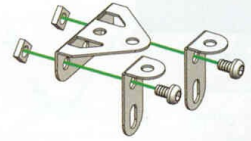

**2**

	x1
	x2
	x1
	x1
	x4
	x4

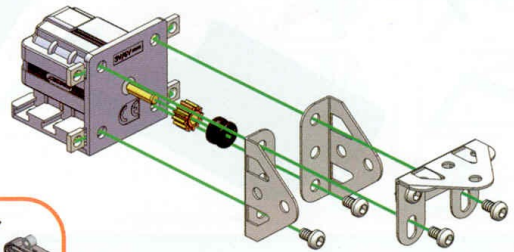

**5**

**3**

	x2		x2
	x1		x2

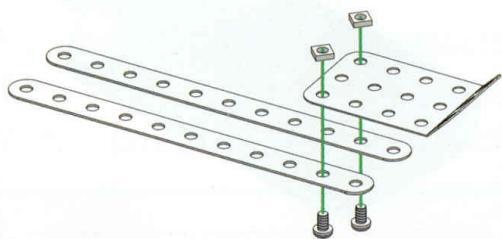

**4**

	x1
	x2
	x2

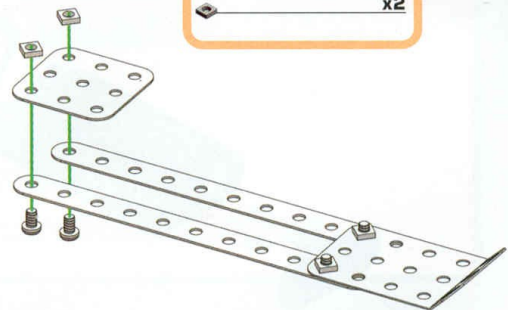

5

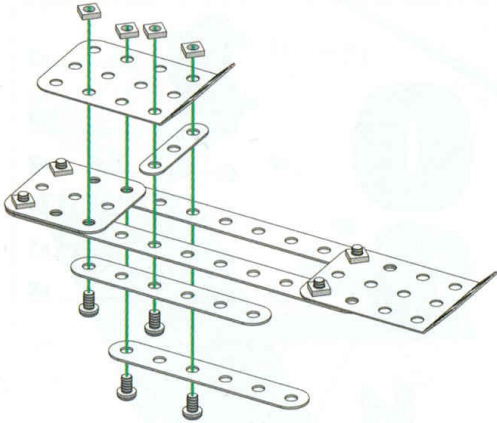
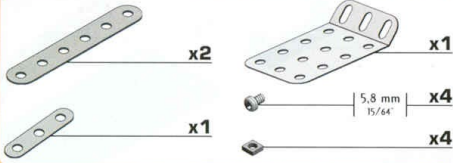

6 (2)+

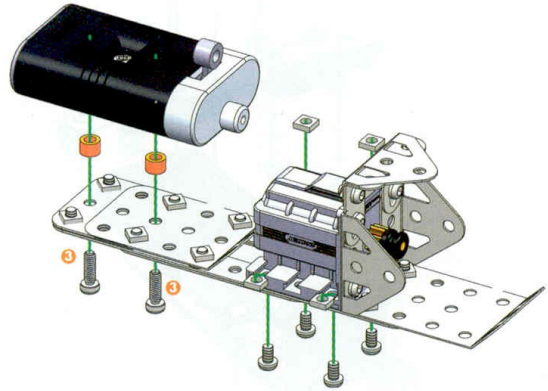

7

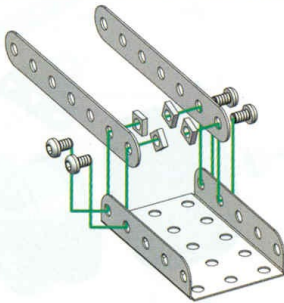
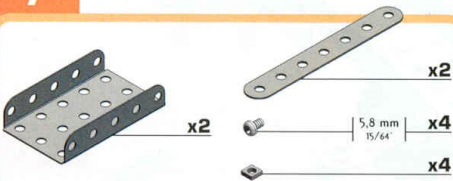

8

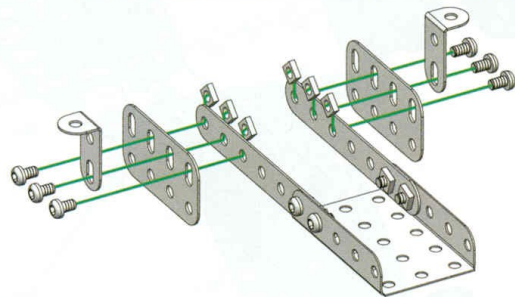
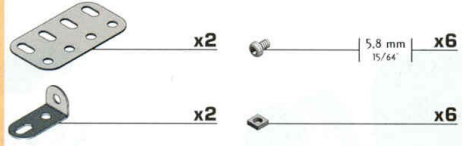

9

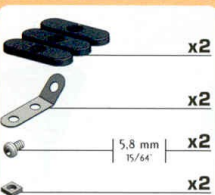

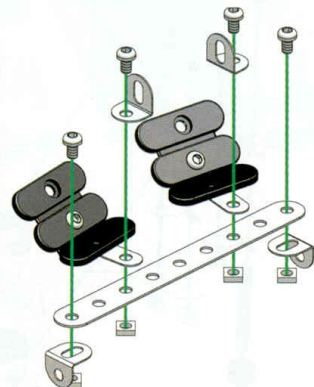
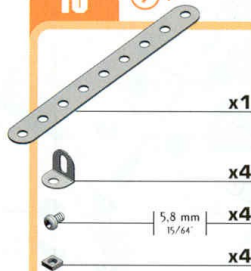

x2

10 (9)+



**11****6 + 8 + 10 +**

	5,8 mm 15/64"	<b>x4</b>
		<b>x2</b>

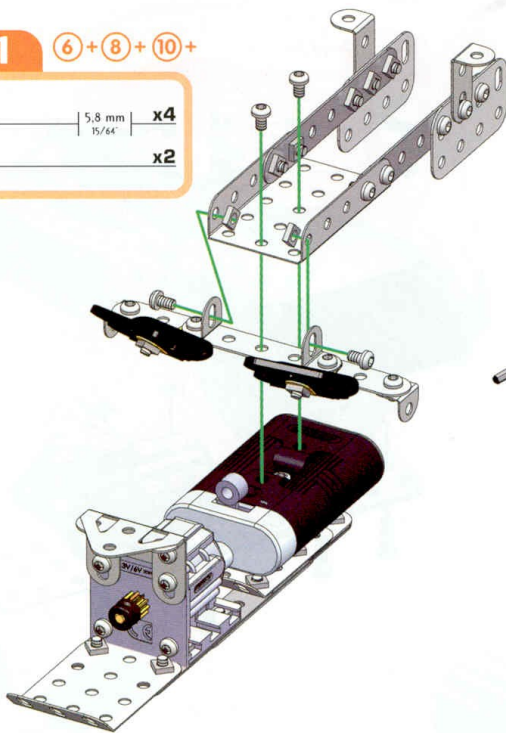
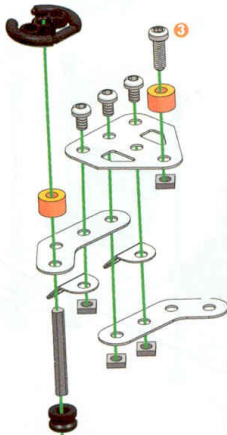
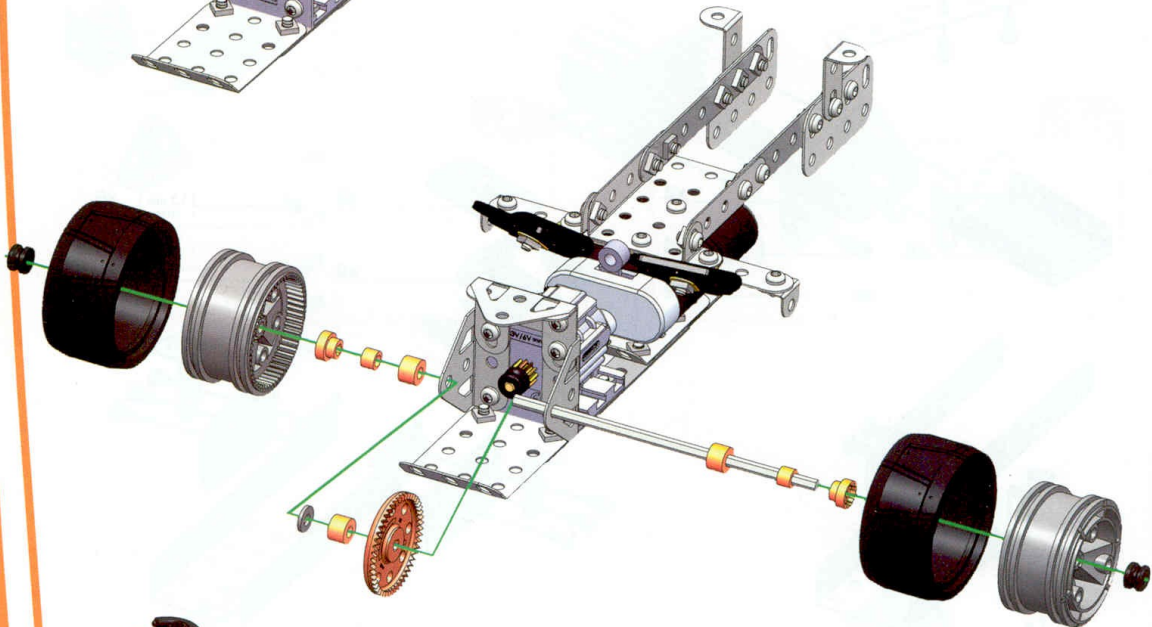
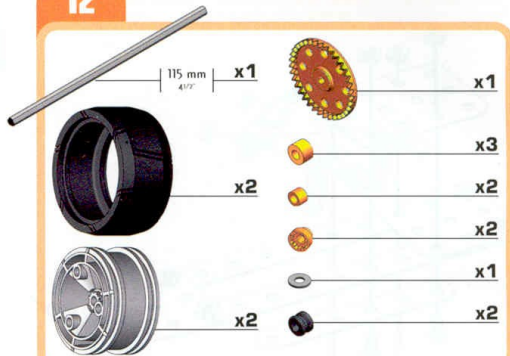
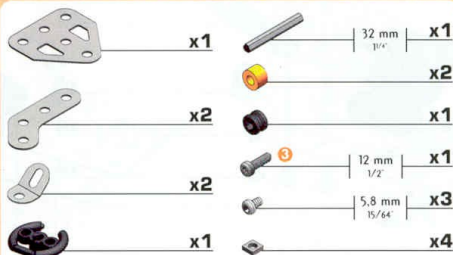
**12****13**



14

(13) +

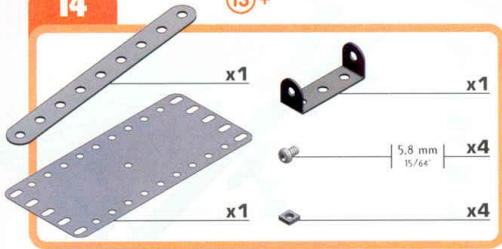

15

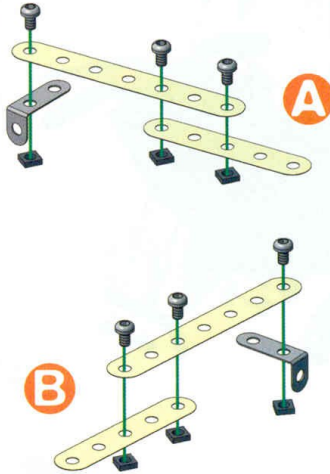
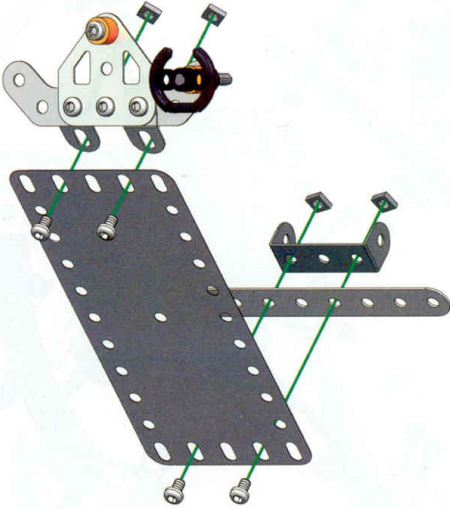
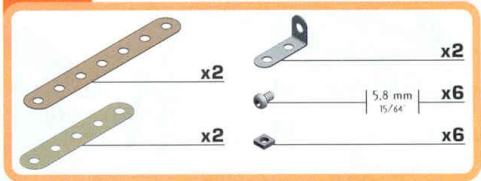



16

17

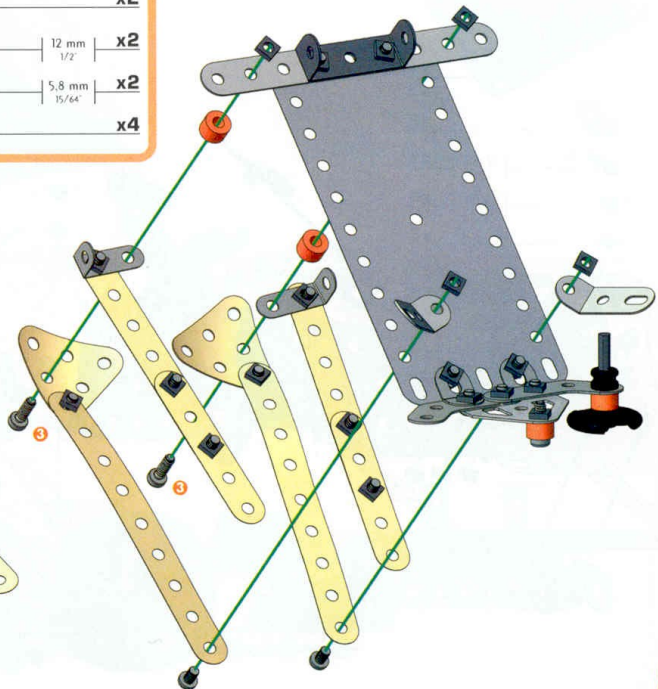
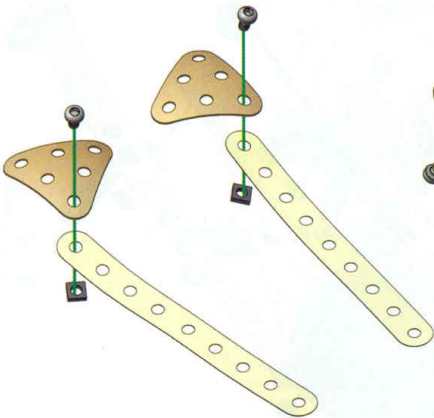
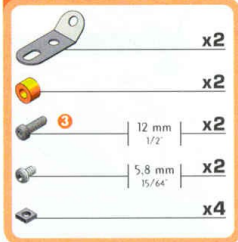
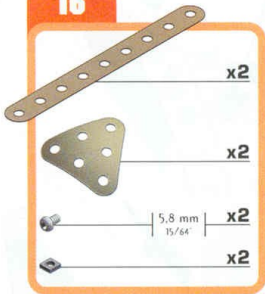





(14) + (15) + (16) +

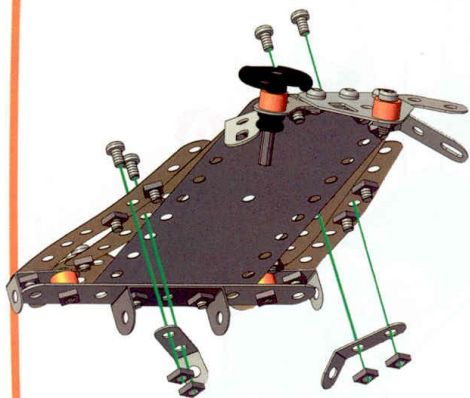





**18****17+**

-  x2
-  5,8 mm 15/64 x4
-  x4

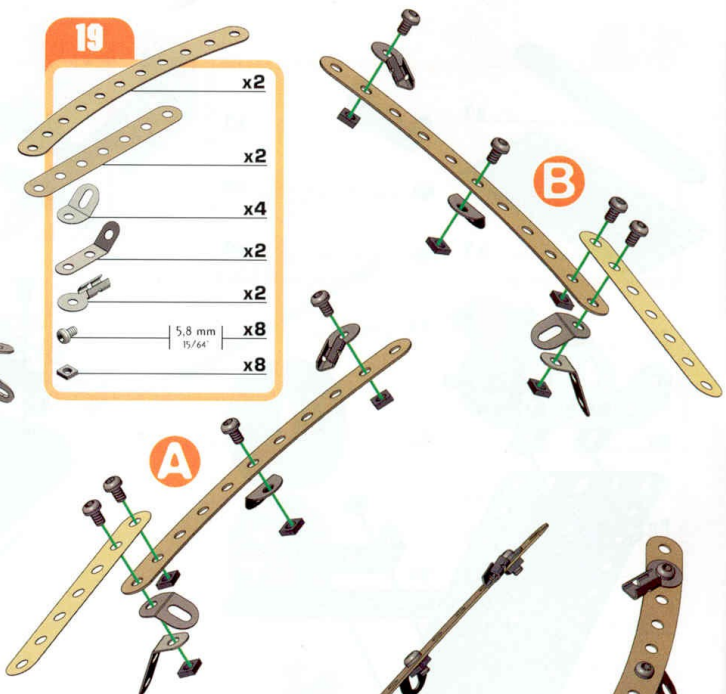

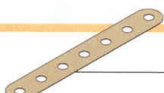

**19**

-  x2
-  x2
-  x4
-  x2
-  x2
-  5,8 mm 15/64 x8
-  x8

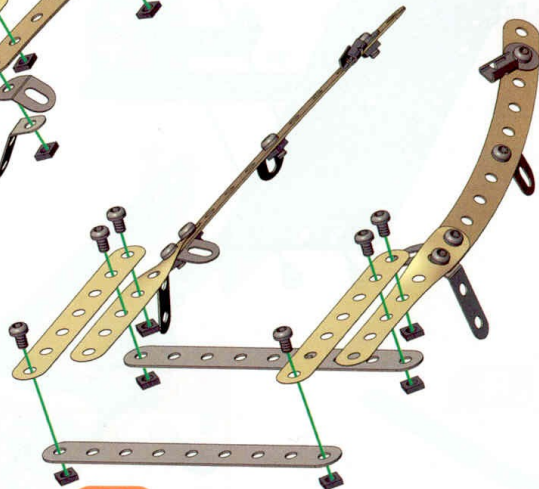
**20**

-  x2
-  x2
-  5,8 mm 15/64 x6
-  x6

**21**

-  x1
-  x2
-  12 mm 1/2 x1
-  5,8 mm 15/64 x4
-  x5

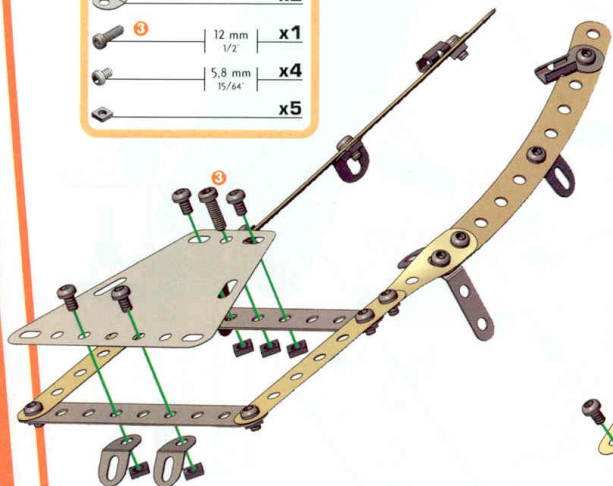
**22**

-  x2
-  x2
-  5,8 mm 15/64 x6
-  x6

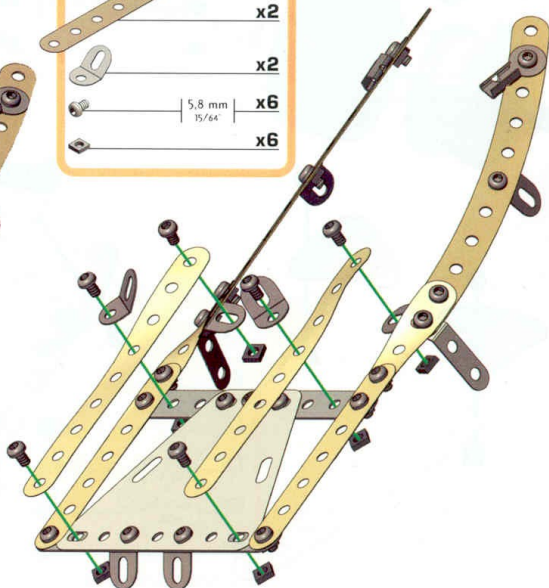

23

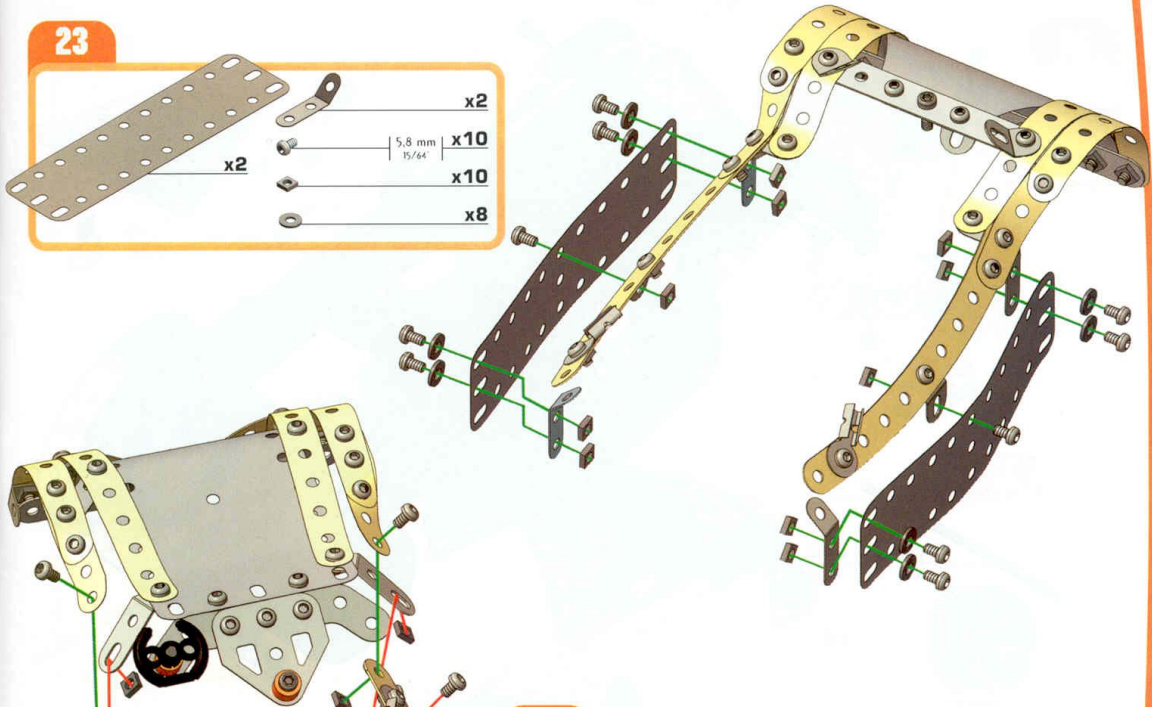
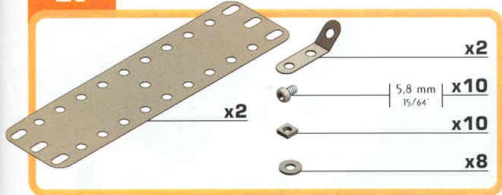

24

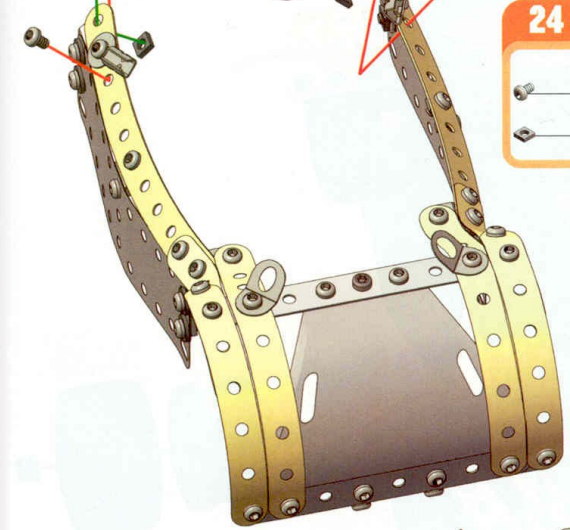
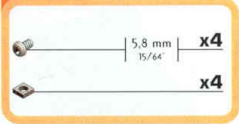

25

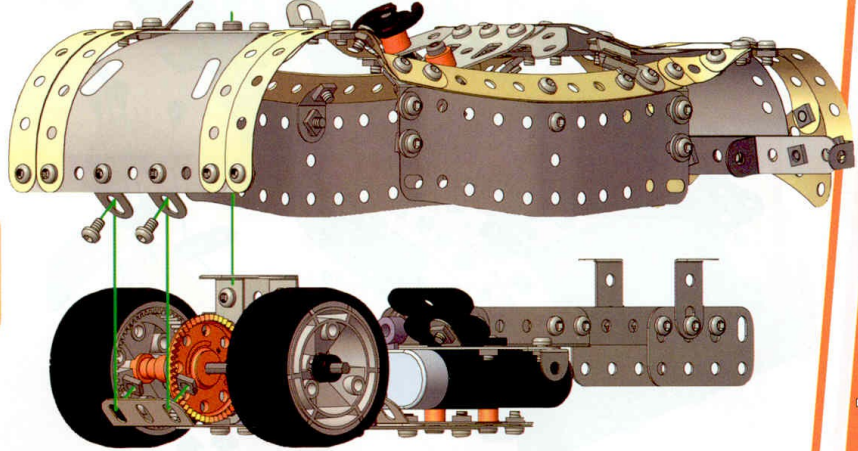
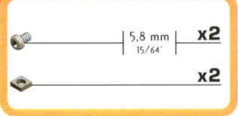

26

- 5,8 mm  $\frac{15}{64}$  x4
- x4

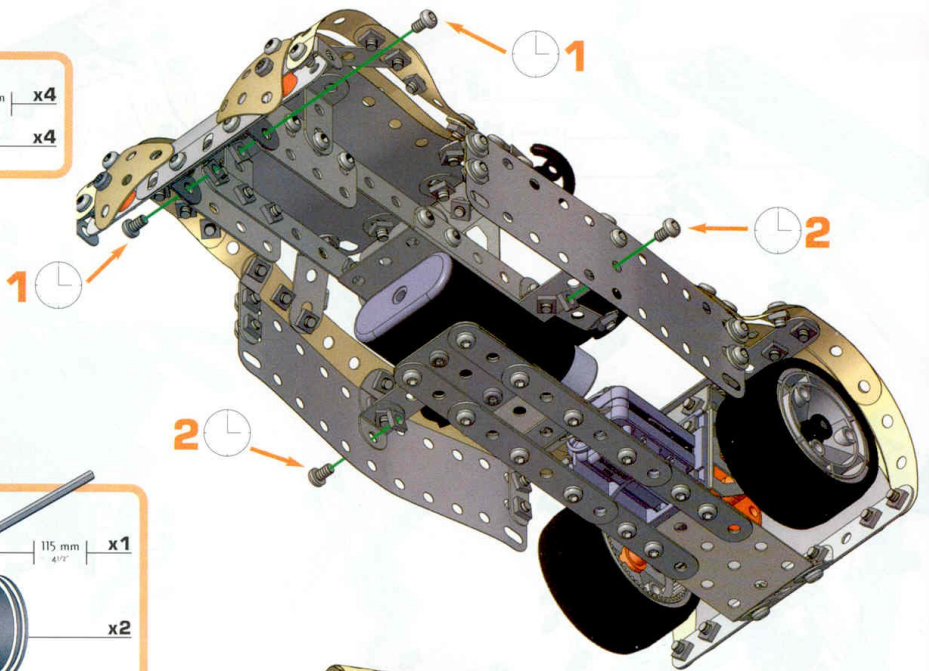

27

- 115 mm  $4\frac{1}{2}$  x1
- x2
- x2
- x6
- x2

2

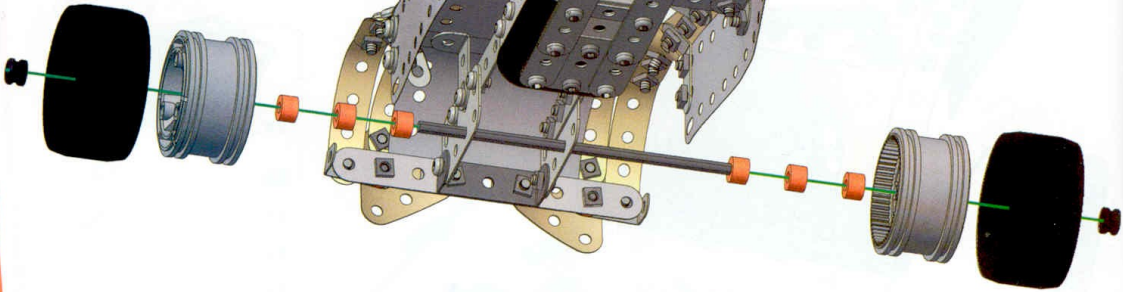
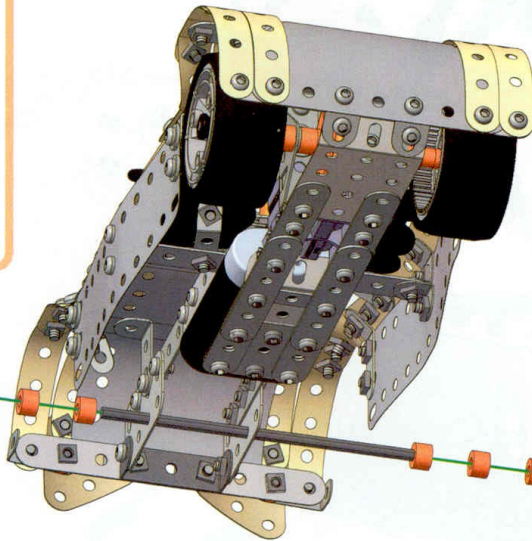

28

- x1
- x2
- x2
- 5,8 mm  $\frac{15}{64}$  x4
- x4

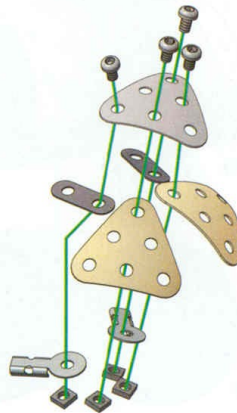

29

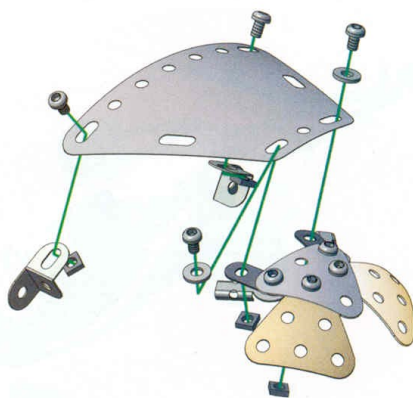
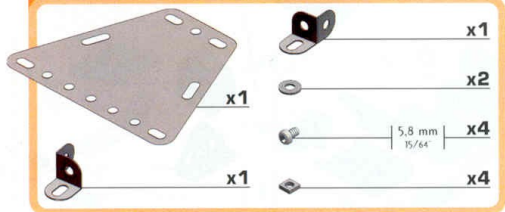

30

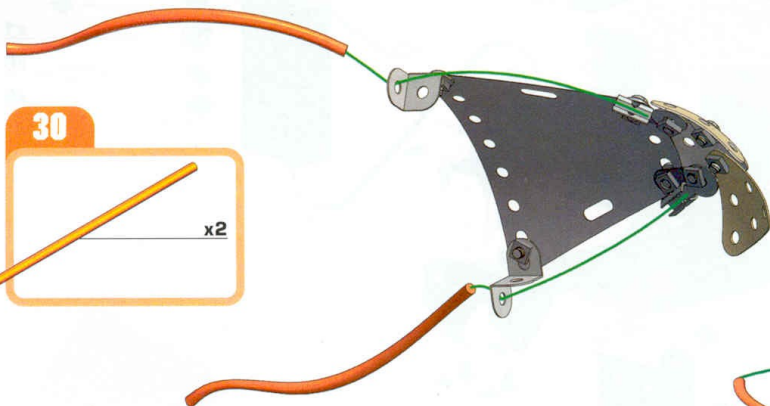
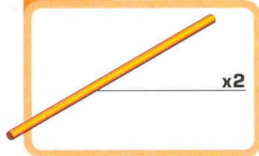

31

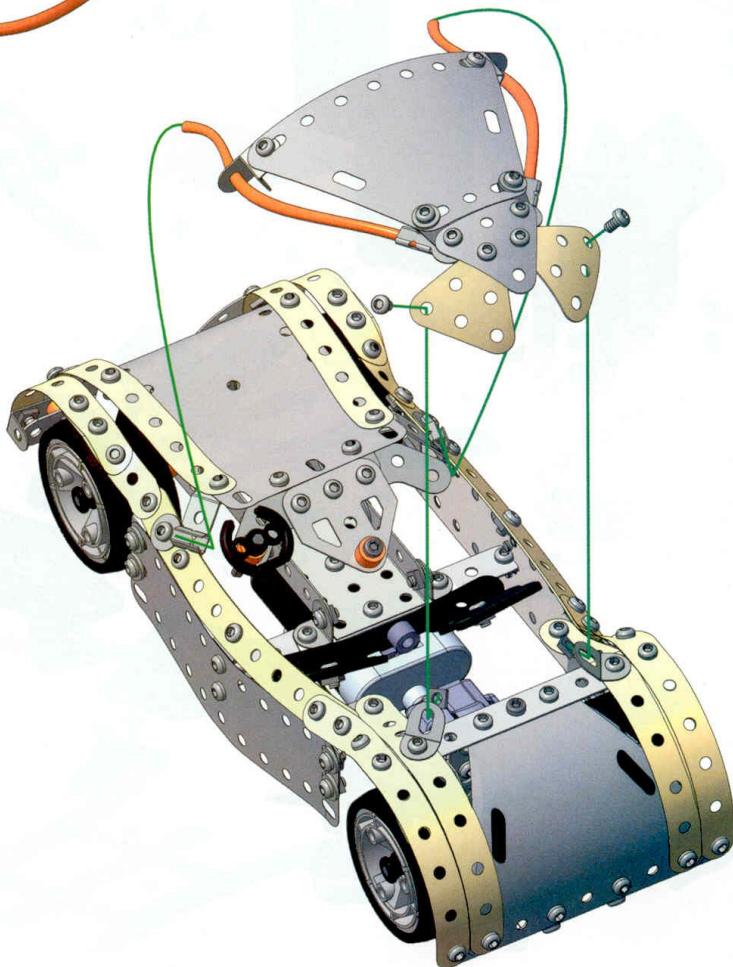
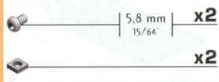



**1**

- x1
- x3
- x1
- x1
- x1
- 5,8 mm 15/64 x6
- x6

**5**

- x1
- x1

**2**

- x1
- x1
- x2
- 5,8 mm 15/64 x6
- x5

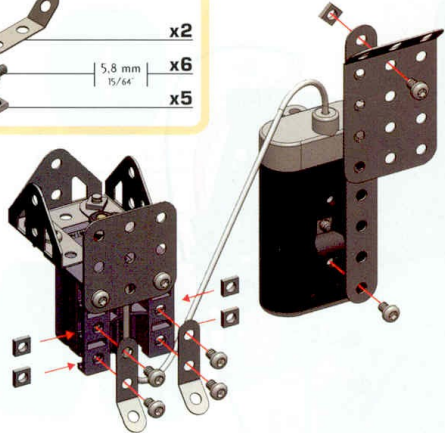
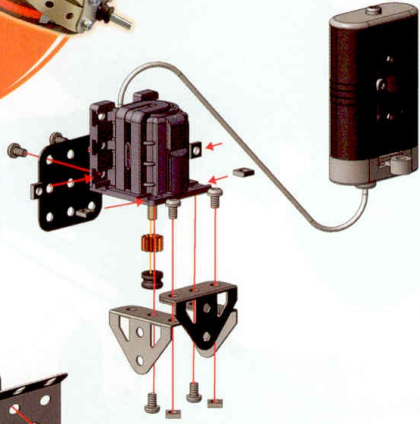

**3**

- x2
- 5,8 mm 15/64 x1
- x1

**5**





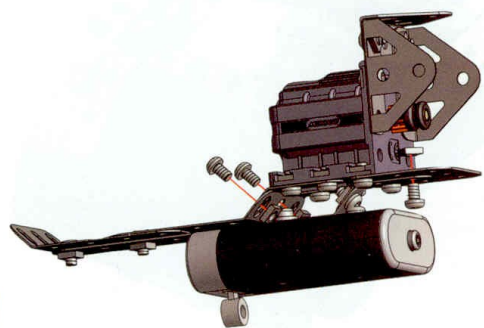
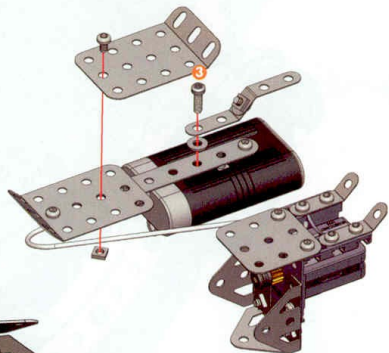

- 5,8 mm 15/64 x3
- x3

**4** (2)+(3)+

- x1
- x1
- 12 mm 1/2" 3 x1
- 5,8 mm 15/64 x1
- x1









6

-  x2
-  x2
-  x1
-  3 | 12 mm | 1/2" | x1
-  | 5,8 mm | 15/64" | x1
-  x2





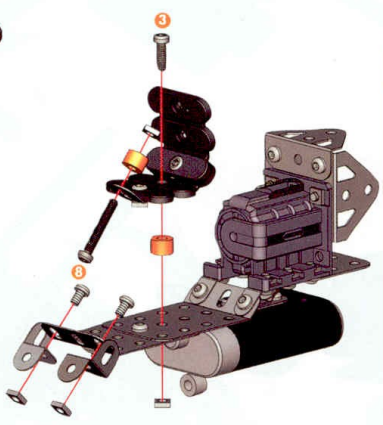

7

-  x1
-  x1
-  x2
-  8 | 25,4 mm | 1 1/2" | x1
-  5 | 12 mm | 1/2" | x1
-  | 5,8 mm | 15/64" | x2
-  x4







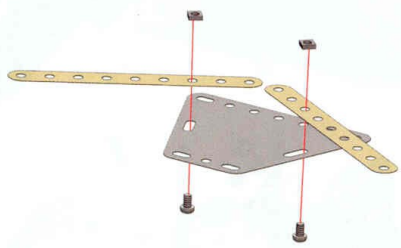

8

-  x1
-  x2
-  | 5,8 mm | 15/64" | x2
-  x2



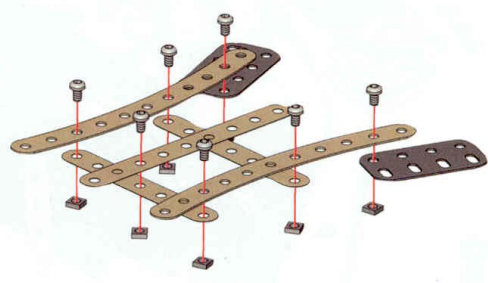

9

-  x1
-  x2
-  x2
-  x2
-  | 5,8 mm | 15/64" | x7
-  x7



10

(8) +

-  x2
-  | 5,8 mm | 15/64" | x3
-  x3

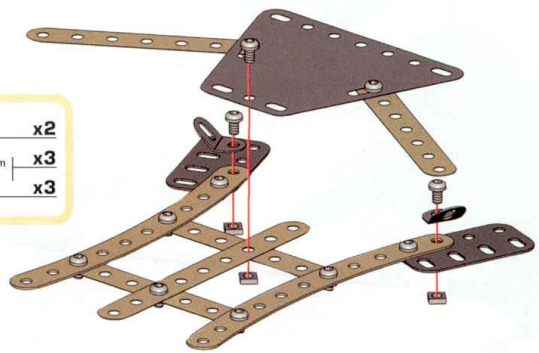

**11****7+ 10+**

	<b>x1</b>
	<b>x1</b>
	<b>x3</b>
	<b>x3</b>

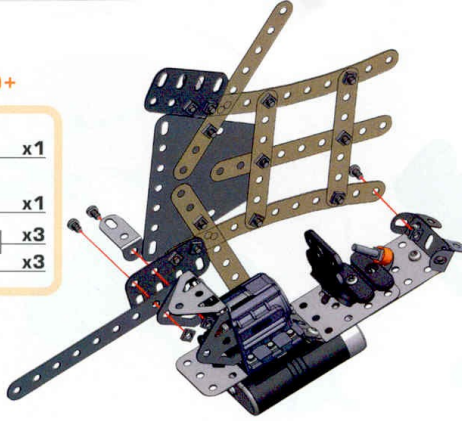
**12**

	<b>x1</b>
	<b>x1</b>
	<b>x4</b>
	<b>x1</b>
	<b>x1</b>
	<b>x3</b>
	<b>x5</b>

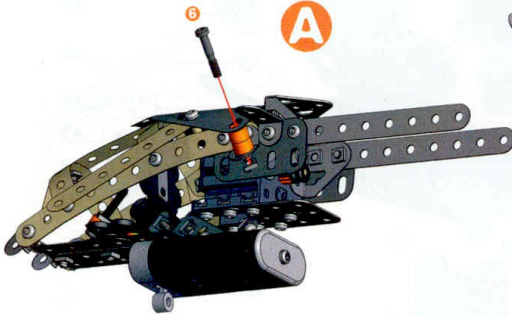
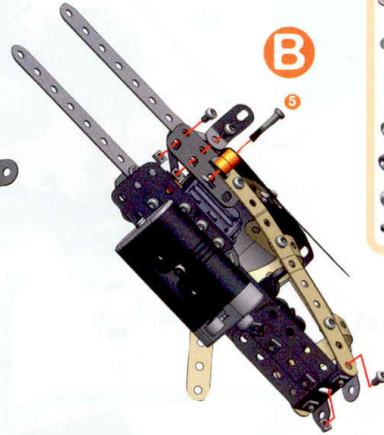
**A****B****13**

	<b>x2</b>
	<b>x1</b>
	<b>x2</b>
	<b>x5</b>
	<b>x5</b>

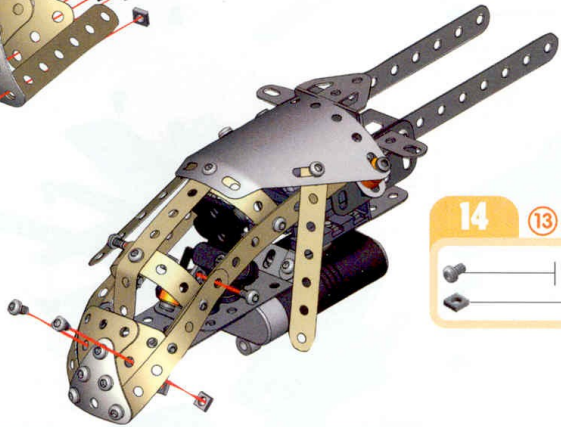
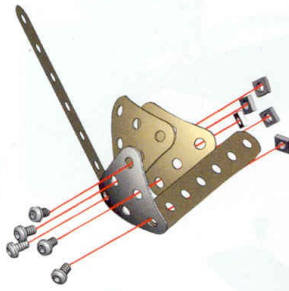
**14****13+**

	<b>x4</b>
	<b>x4</b>



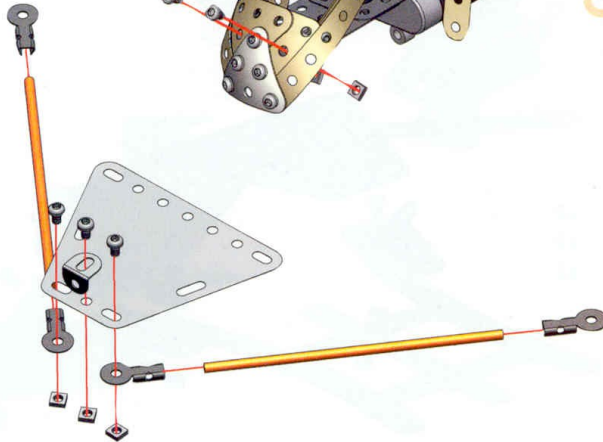

**15**

	<b>x2</b>
	<b>x1</b>
	<b>x1</b>
	<b>x4</b>
	<b>x3</b>
	<b>x3</b>





16

-  90 mm  $\frac{3}{16}$ " x1
-  x1
-  x1
-  5,8 mm  $\frac{15}{64}$ " x4
-  x4

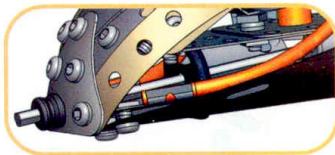
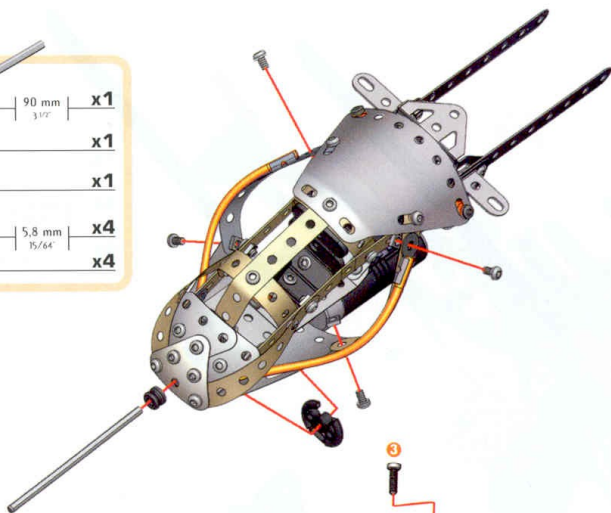





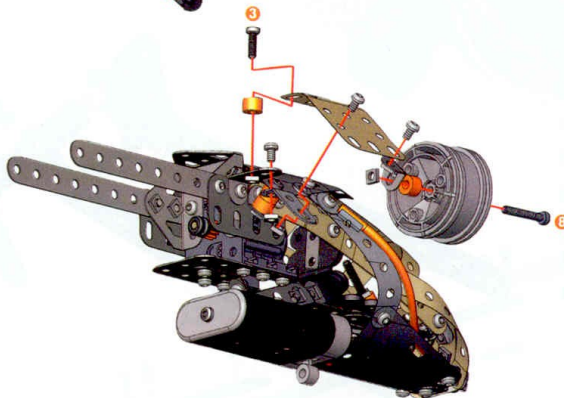





17

-  x1
-  x1
-  x1
-  x1
-  x1
-  x2
-  25,4 mm  $\frac{29}{32}$ " x1
-  12 mm  $\frac{1}{2}$ " x1
-  5,8 mm  $\frac{15}{64}$ " x3
-  x5





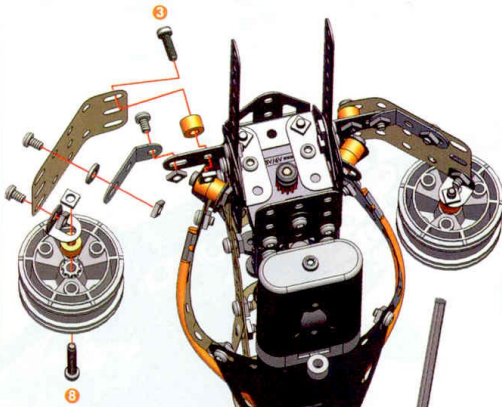

18

-  x1
-  x1
-  x1
-  x1
-  x1
-  x2
-  25,4 mm  $\frac{29}{32}$ " x1
-  12 mm  $\frac{1}{2}$ " x1
-  5,8 mm  $\frac{15}{64}$ " x3
-  x5







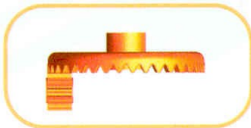
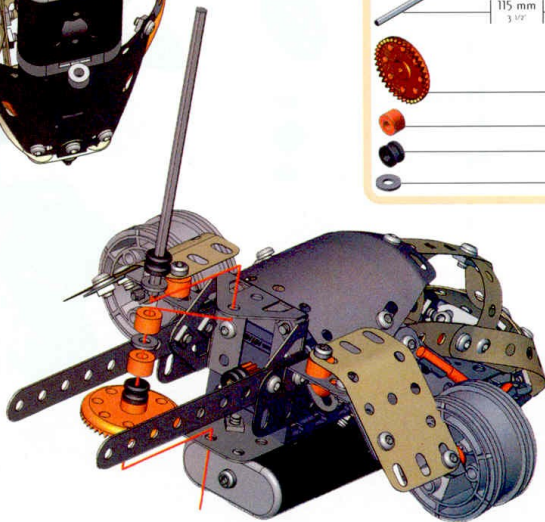

19

-  115 mm  $\frac{3}{16}$ " x1
-  x1
-  x2
-  x2
-  x2









20

-  x2
-  x2
-  x2
-  x1
-  5,8 mm | 15/64" x4
-  x4





21

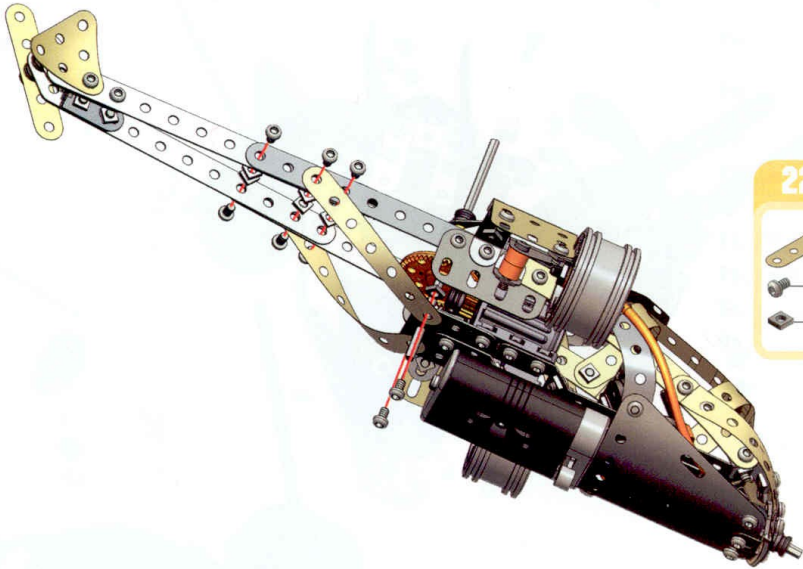

-  x1
-  32 mm | 1 1/4" x1
-  x1
-  x3
-  x3
-  5,8 mm | 15/64" x1
-  x1



22



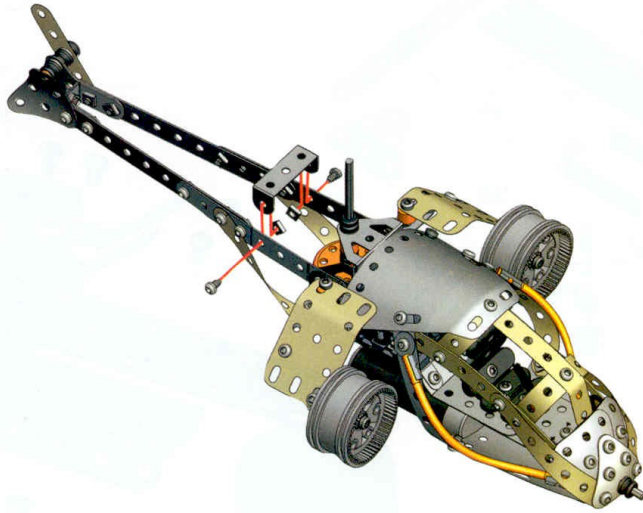

-  x2
-  5,8 mm | 15/64" x8
-  x8

23

-  x1
-  x2
-  x2







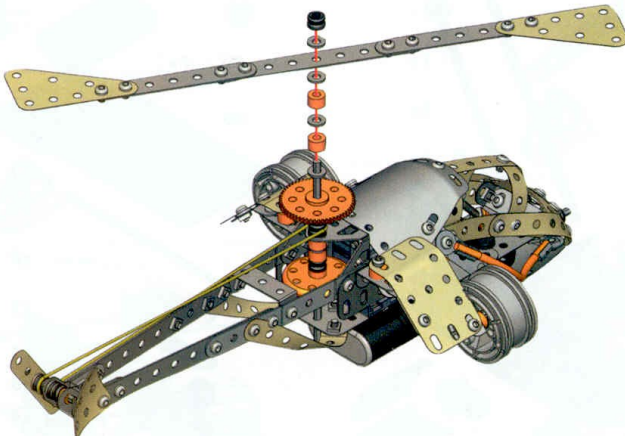
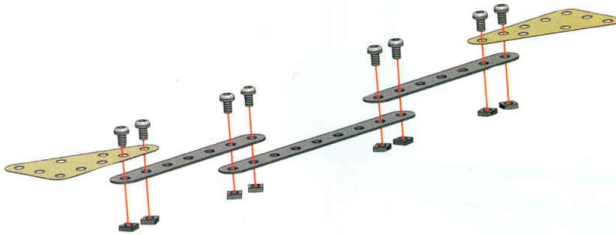

24

-  x1
-  x2
-  x2
-  x8
-  x8



25

-  x1
-  x2
-  x1
-  x4
-  x1
-  x1

26

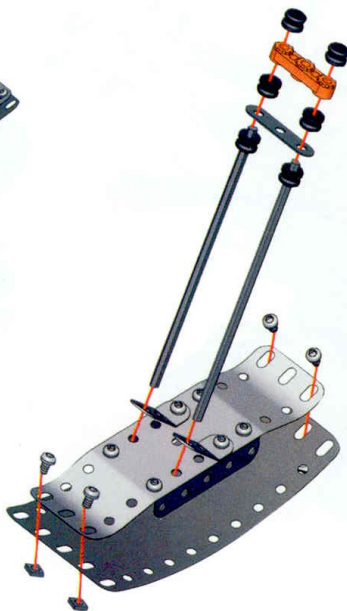
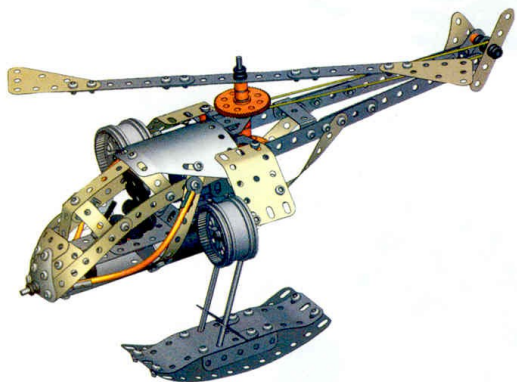
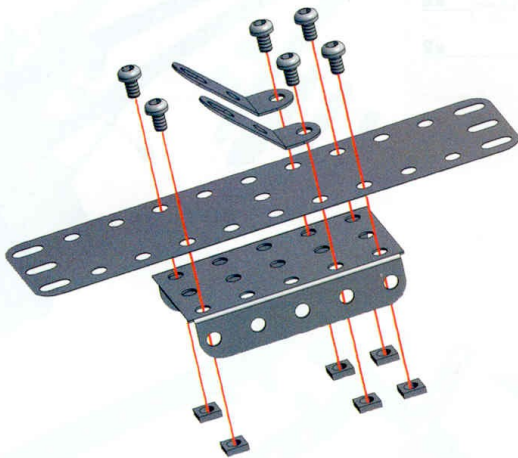
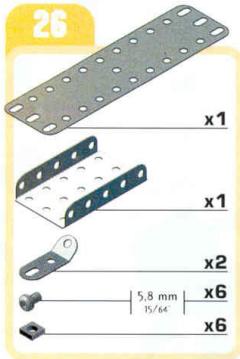

27

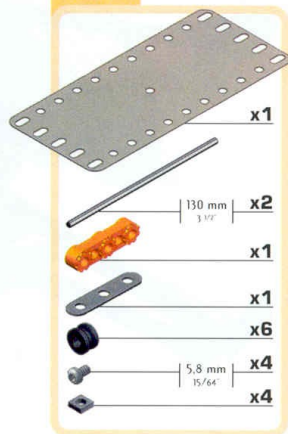



**1**

	x3		x6
	x3		x6
			x3

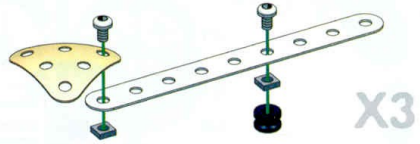

**2**

	x1
	x1
	x3
	x3
	x3

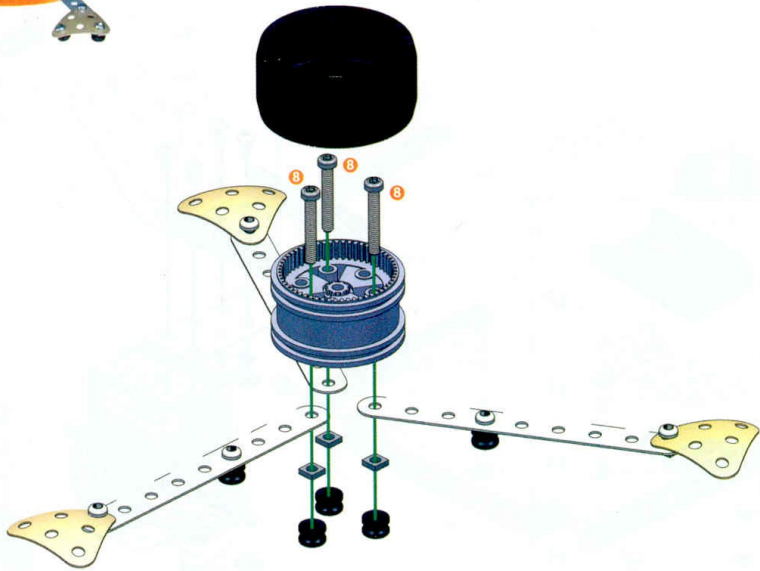

**3**





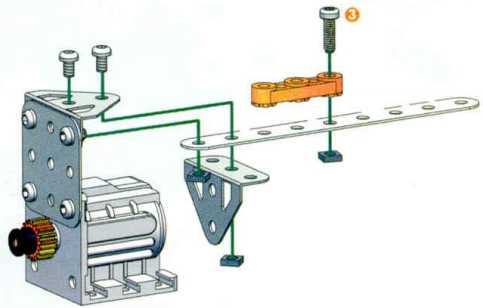
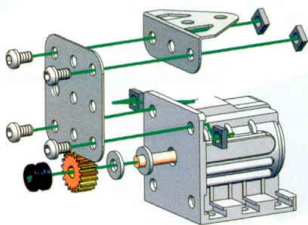

	x1		x1
	x1		x1
	x1		x2
	x1		x4
			x4

**4**

	x1		x1
	x1		x1
			x2
			x3





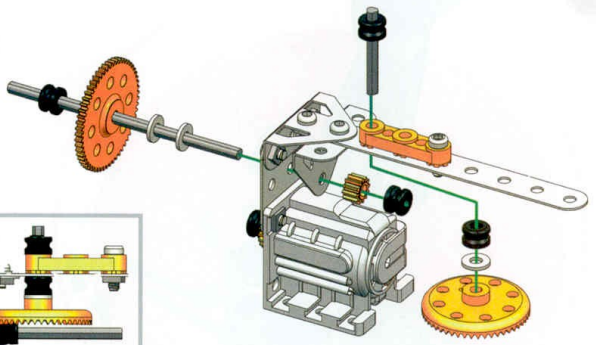
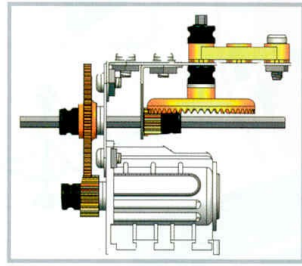

5

-  90 mm  $\frac{3}{2}$ " x1
-  32 mm  $\frac{11}{4}$ " x1
-  x1
-  x1
-  x1
-  x4
-  x3





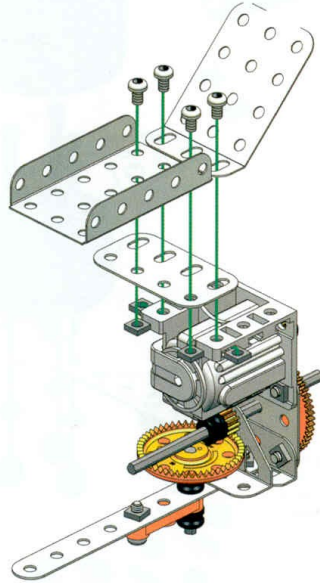

6

-  x1
-  x1
-  x1
-  5,8 mm  $\frac{15}{64}$ " x4
-  x4

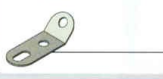

7

-  x1
-  x2
-  x2
-  5,8 mm  $\frac{15}{64}$ " x8
-  x6

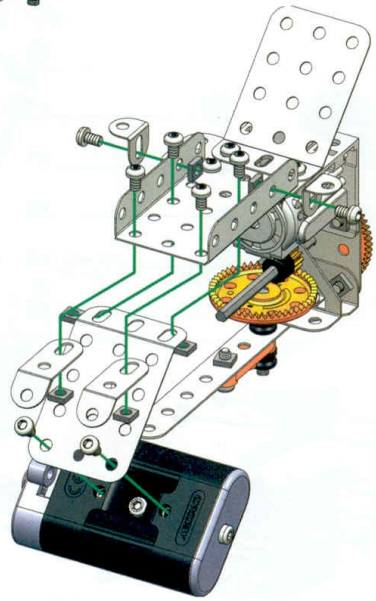

8

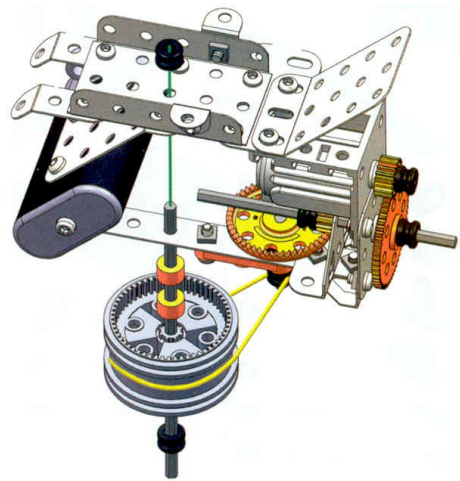
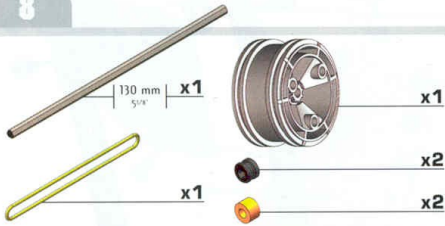

9

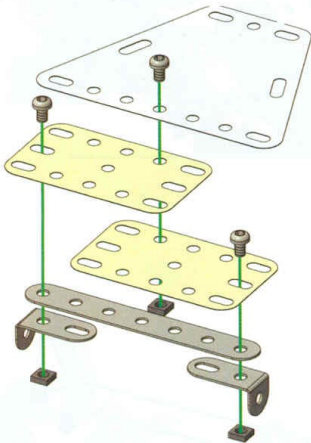
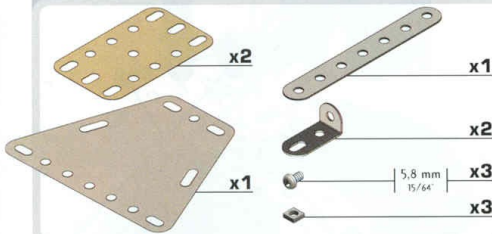

10

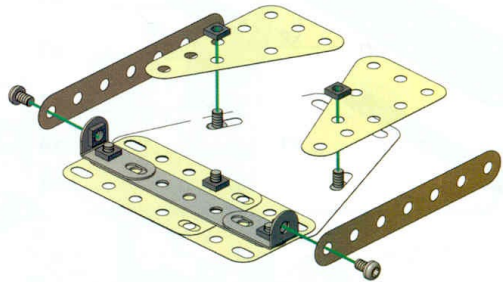
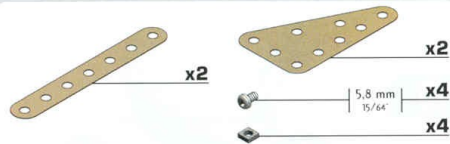





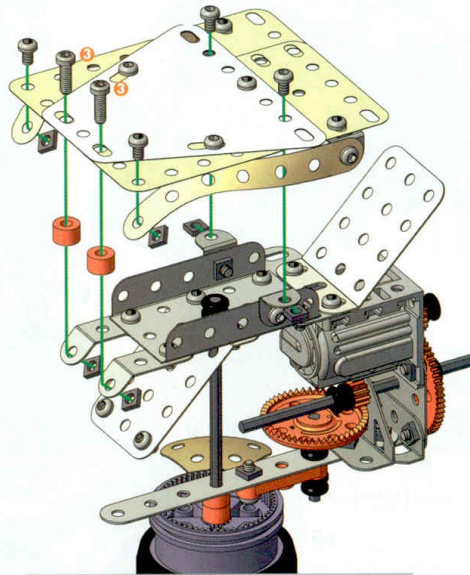
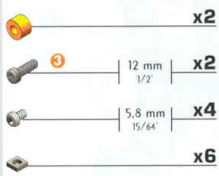

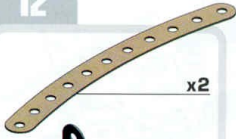

11





(2) + (8) + (10) +

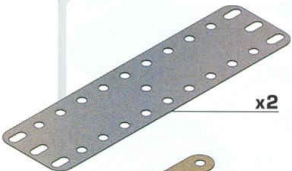
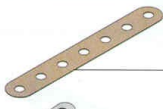

12

-  x2
-  x1
-  x2
-  x1
-  x1
-  | 12 mm 1/2" x2
-  | 5,8 mm 15/64" x6
-  x2
-  x6

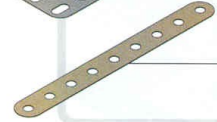

13

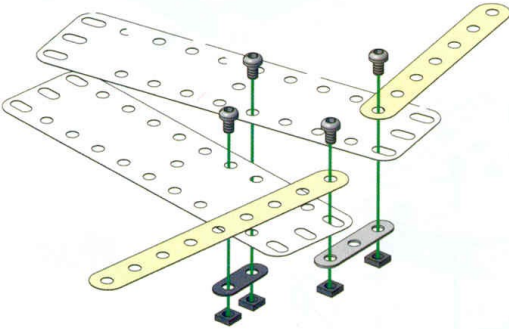
-  x2
-  x1
-  x1
-  x1
-  x1
-  | 5,8 mm 15/64" x4
-  x4



14



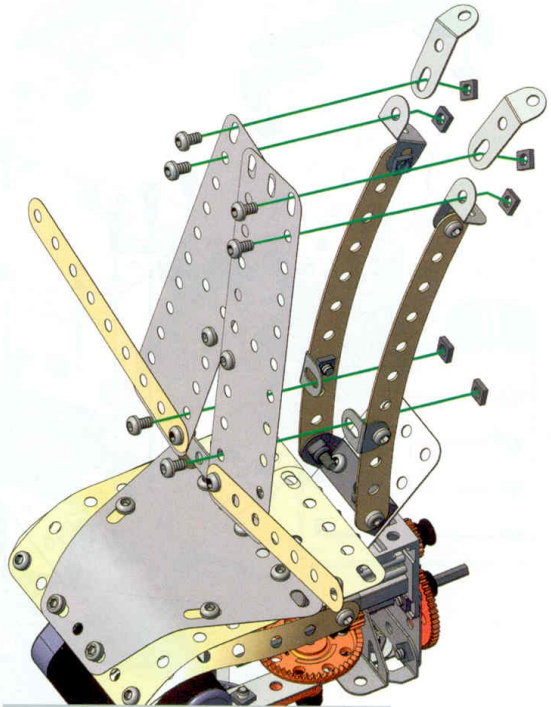
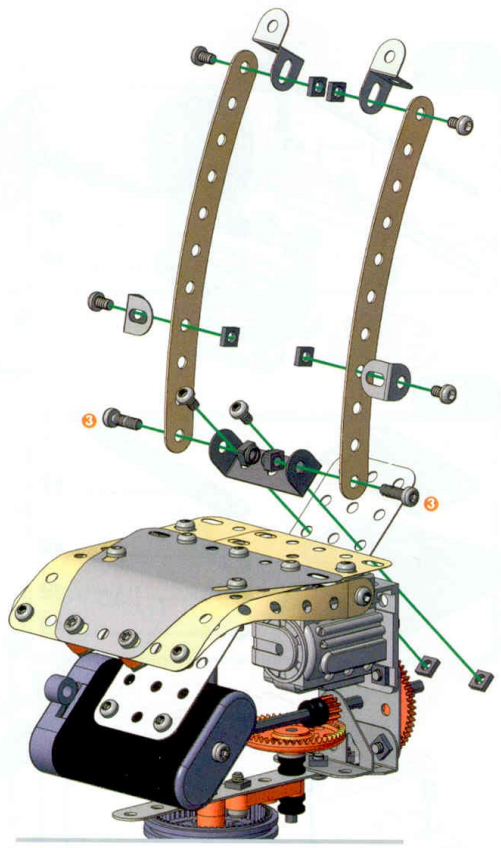

(12) + (13) +

-  x2
-  | 5,8 mm 15/64" x6
-  x6



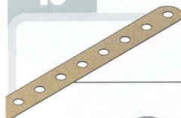



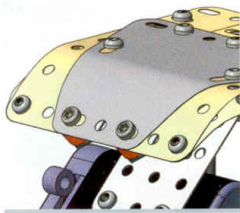
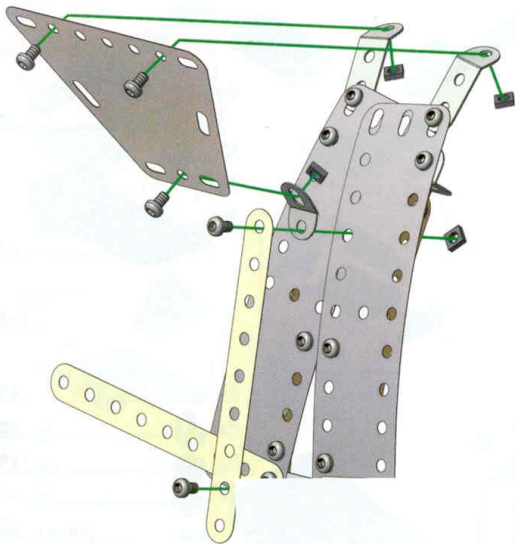

15

-  x1
-  x1
-  x1
-  x5
-  x5

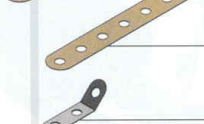





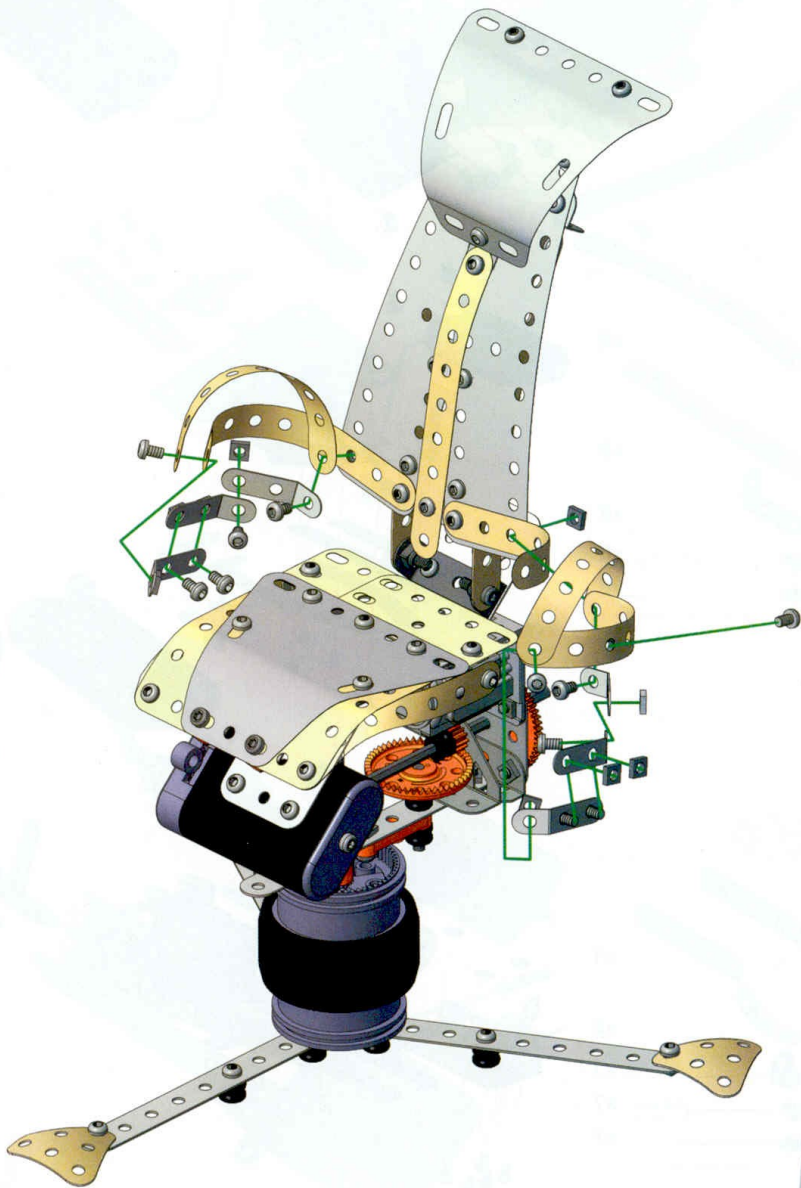

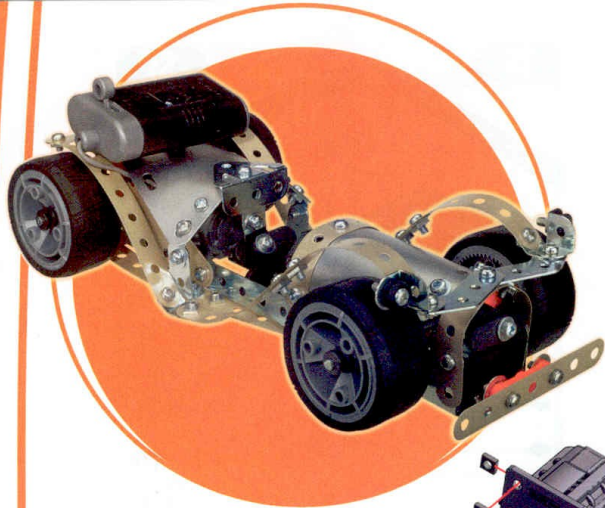

16

-  x1
-  x1
-  x1
-  x1
-  x1







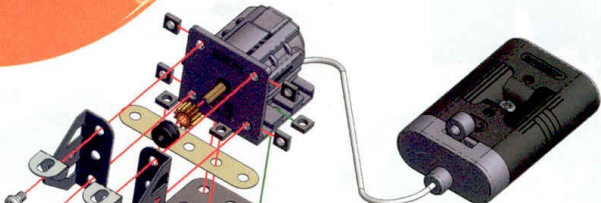

1

-  x1
-  x1
-  x2
-  x1
-  x2
-  x1
-  x1
-  | 5,8 mm | x8
-  | 15/64" | x8



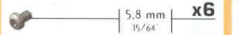

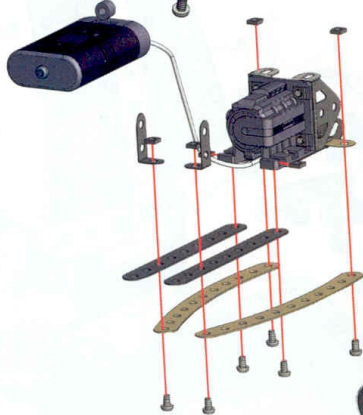

2

-  x2
-  x2
-  x2
-  | 5,8 mm | x6
-  | 15/64" | x6





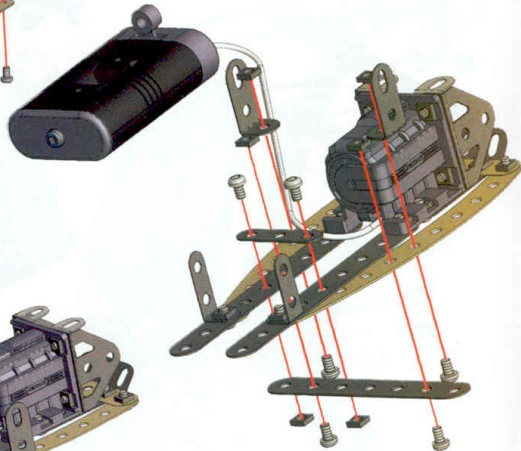

3

-  x1
-  x1
-  x2
-  | 5,8 mm | x6
-  | 15/64" | x6





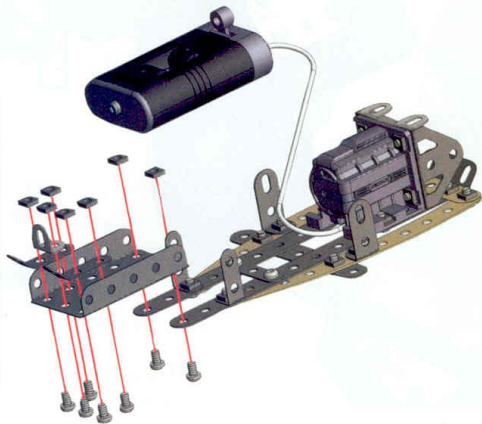

4

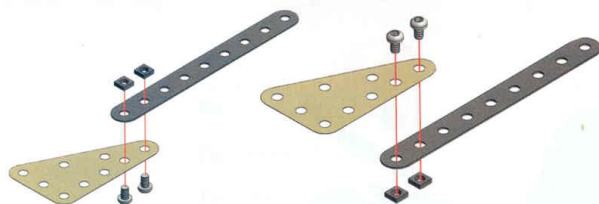
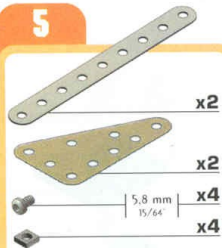
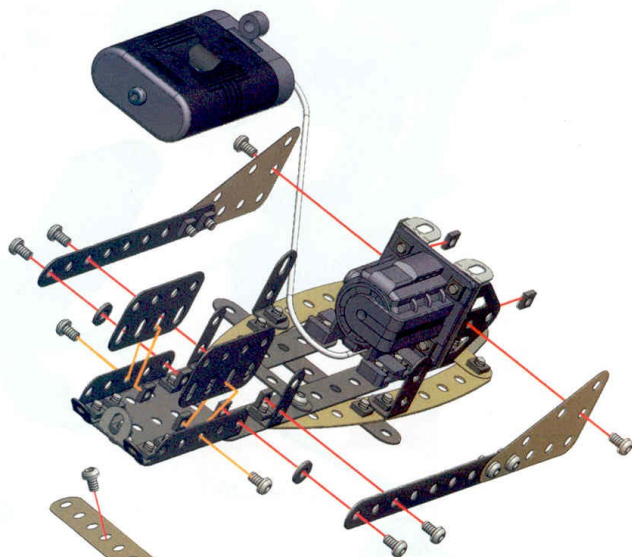
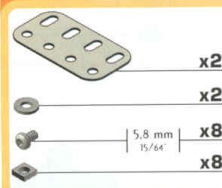
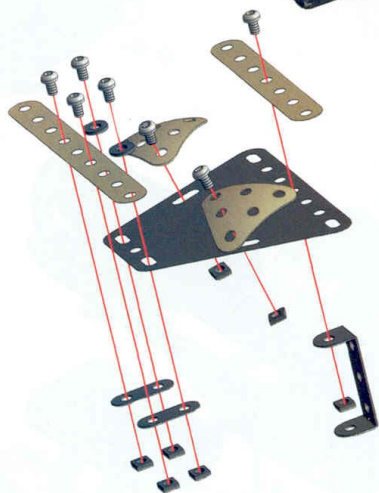
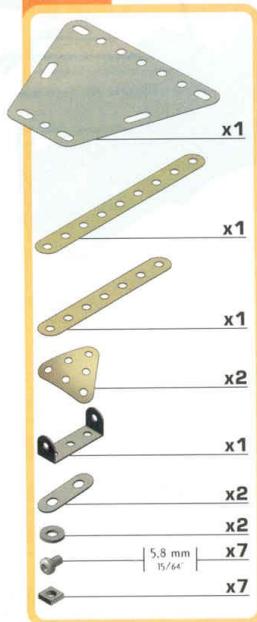
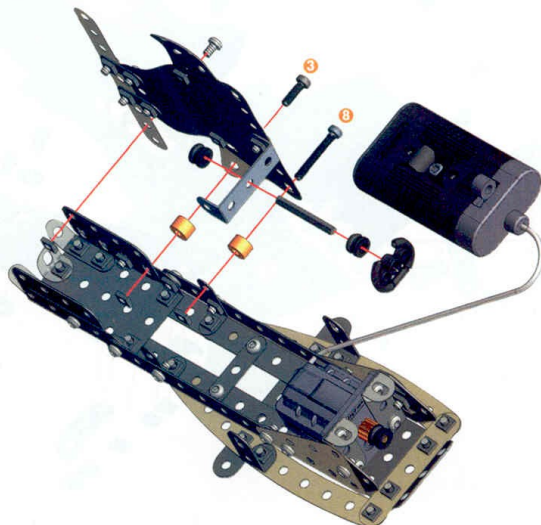
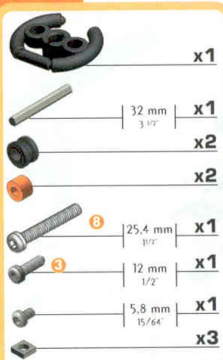
-  x1
-  x2
-  x1
-  | 5,8 mm | x7
-  | 15/64" | x7



**5****6****4 + 5****7****8**







**9**

	x2
 8	25,4 mm $\frac{1}{2}$ x1
 5	12 mm $\frac{1}{2}$ x1
	5,8 mm $\frac{15}{64}$ x1
	x3









**10**

	x1
	x2
	x1
	5,8 mm $\frac{15}{64}$ x5
	x3

**11**

	130 mm $3 \frac{1}{2}$ x1
	x1
	x2
	x3
	x2
	x1

**12**

	x1
	x1
	x1
	x3
	x2
	x1
	x3
	5,8 mm $\frac{15}{64}$ x9
	x9

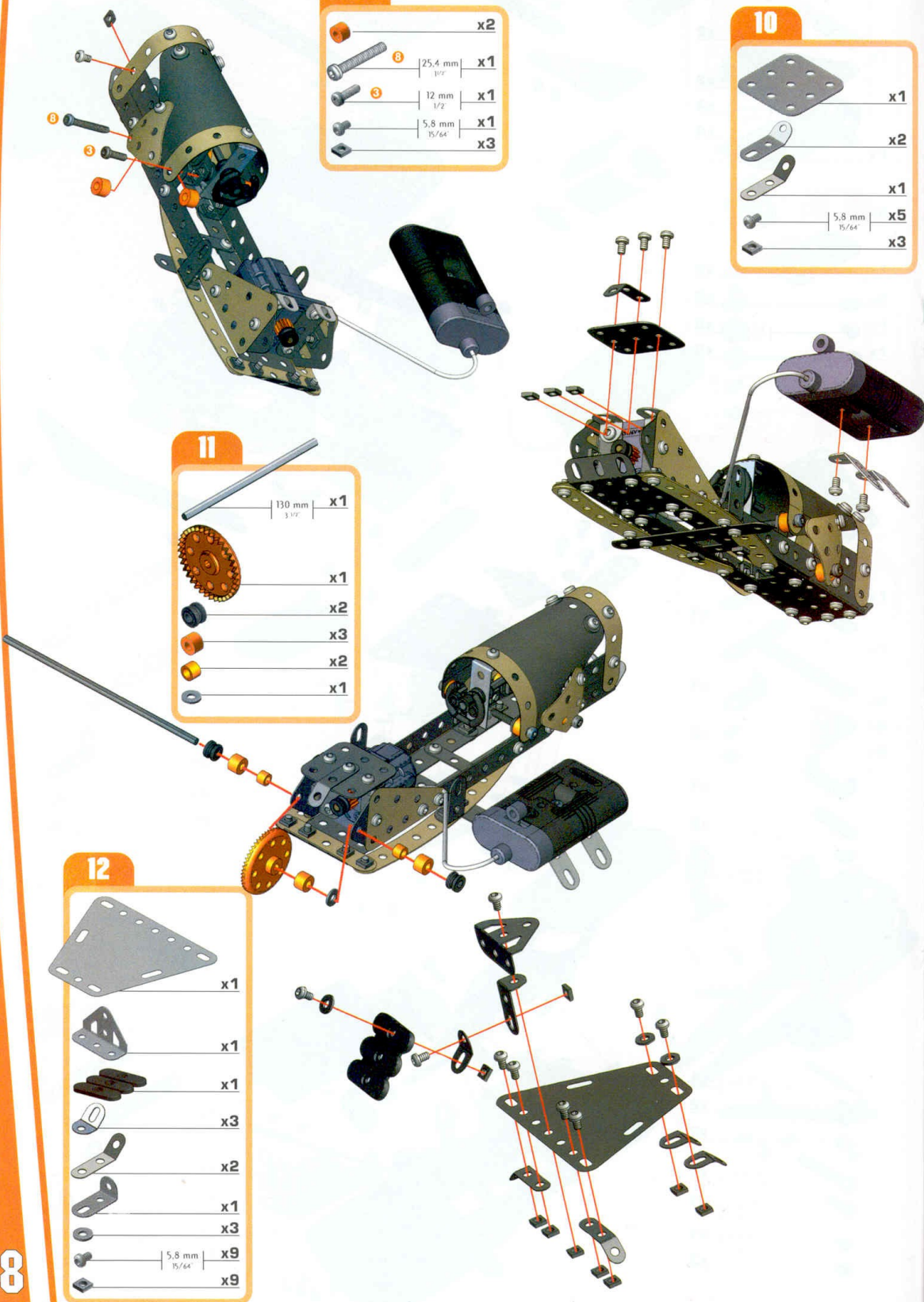

13

11+

	x1
	x2
	x2

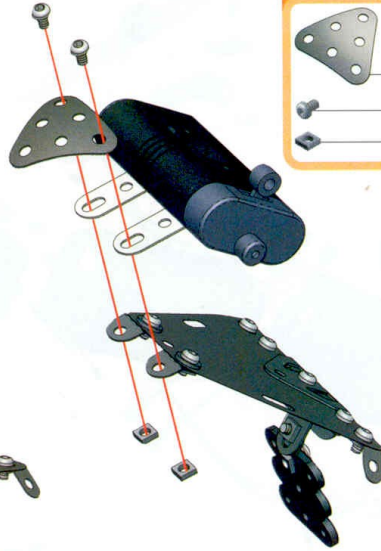

14

13+

	x2
	x1
	x1
	x2
	x3

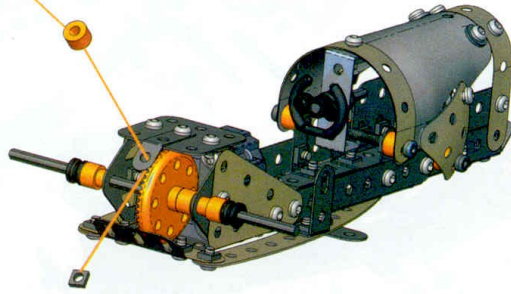
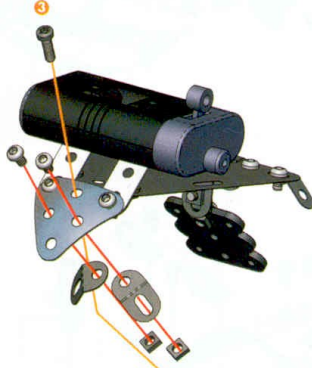





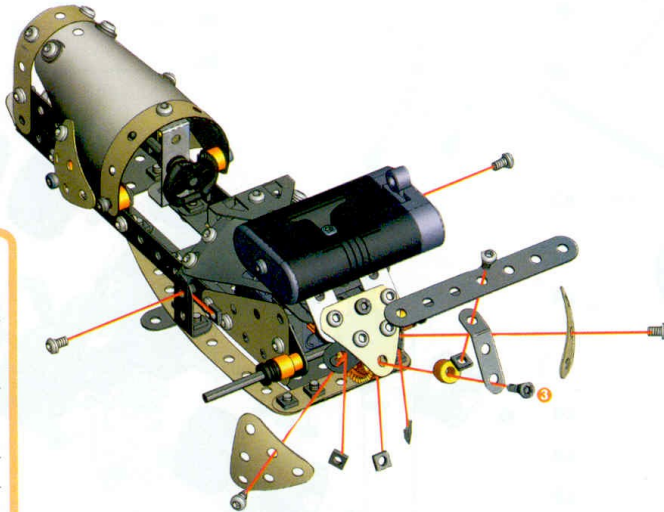



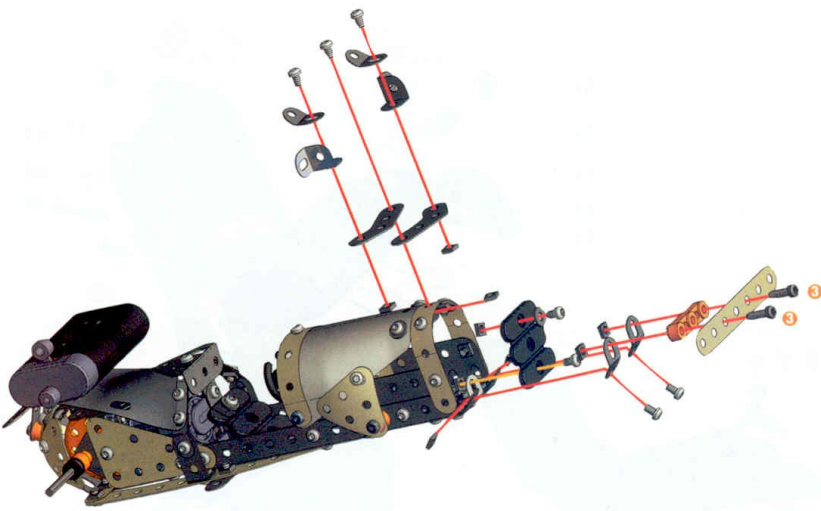

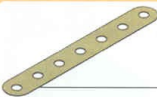

15

	x1
	x2
	x1
	x1
	x1
	x5
	x6









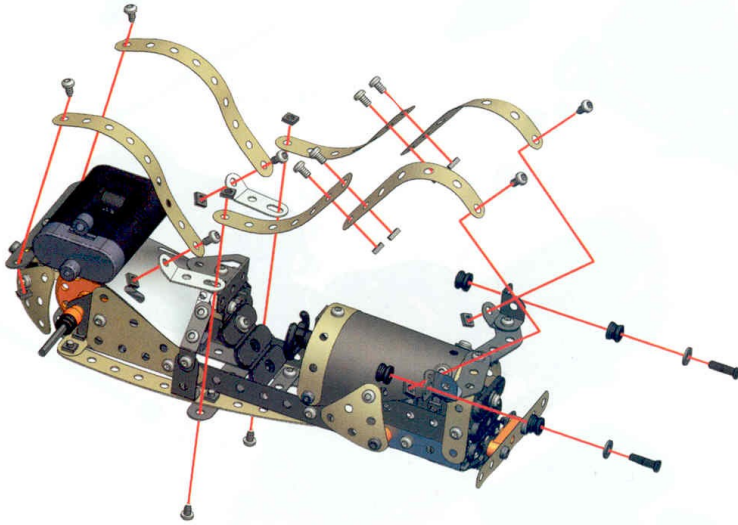

16



-  x1
-  x1
-  x1
-  x2
-  x4
-  x1
-  x1
-  x1
-  x1
-  12 mm 1/2" x2
-  5,8 mm 15/64" x7
-  x9

17



-  x2
-  x4
-  x2
-  x2
-  x4
-  x2
-  5,8 mm 15/64" x12
-  x12

18

-  115 mm 3/8" x1
-  x4
-  x4
-  x4
-  x2
-  x6

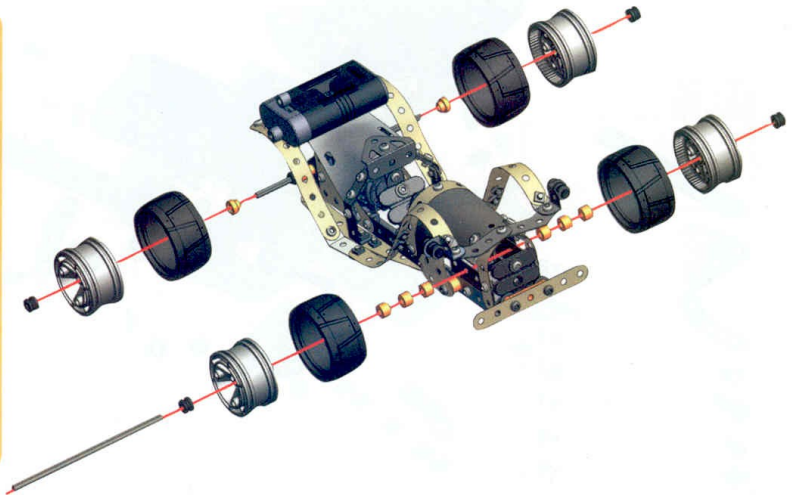

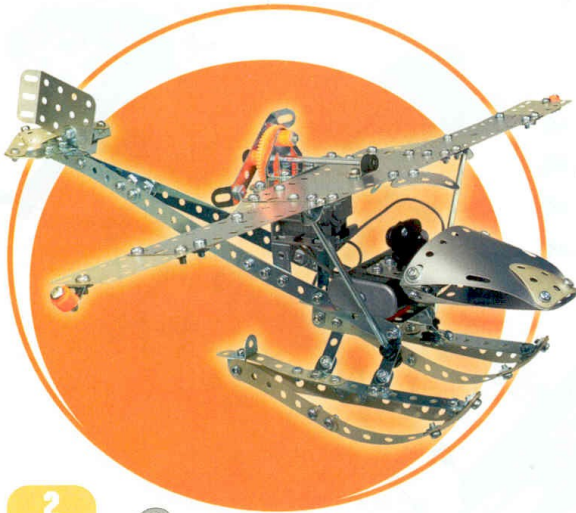

**1**

- 2 x 10-hole Technic beam (x2)
- 2 x 5-hole Technic beam (x2)
- 1 x 3-hole Technic triangle (x1)
- 6 x 5.8 mm 15/64 pins (x6)
- 6 x 5.8 mm 15/64 pins (x6)

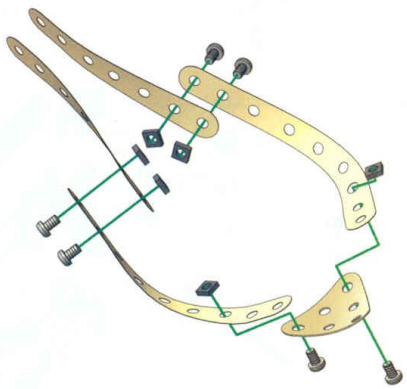

**2**

- 1 x 10-hole Technic beam (x1)
- 1 x 5-hole Technic beam (x1)
- 1 x black Technic bush (x1)
- 2 x Technic washers (x2)
- 1 x Technic L-plate (x1)
- 9 x 5.8 mm 15/64 pins (x9)
- 9 x 5.8 mm 15/64 pins (x9)

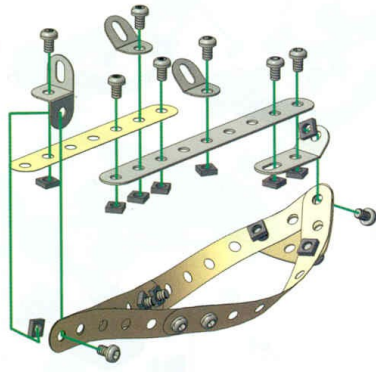

**3**

- 2 x 10-hole Technic beam (x2)
- 2 x 5-hole Technic beam (x2)
- 1 x 3-hole Technic triangle (x1)
- 6 x 5.8 mm 15/64 pins (x6)
- 6 x 5.8 mm 15/64 pins (x6)

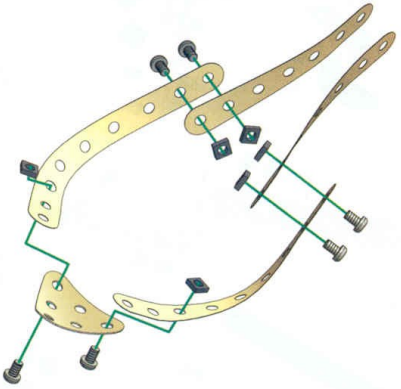

**4**

- 1 x 10-hole Technic beam (x1)
- 1 x 5-hole Technic beam (x1)
- 1 x black Technic bush (x1)
- 2 x Technic washers (x2)
- 1 x Technic L-plate (x1)
- 9 x 5.8 mm 15/64 pins (x9)
- 9 x 5.8 mm 15/64 pins (x9)

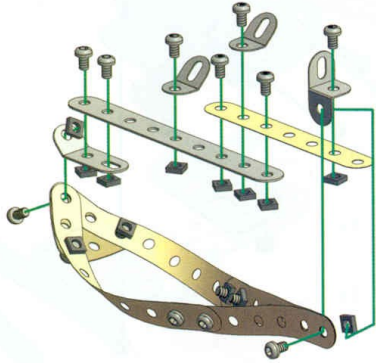

5

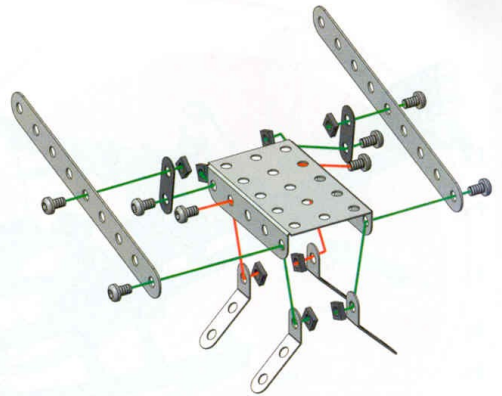
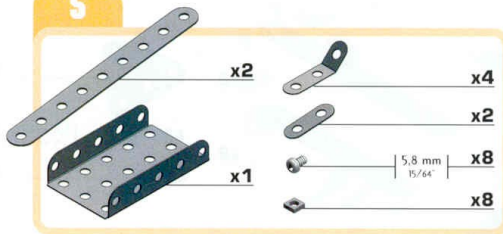

6

(2) + (4) +

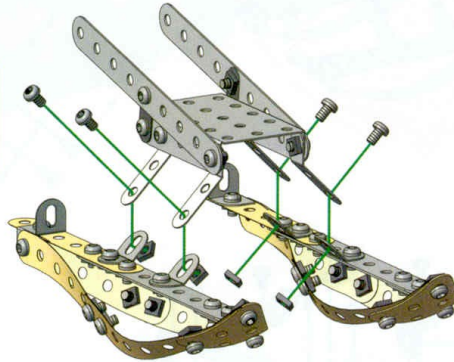
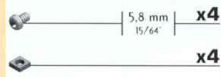

7

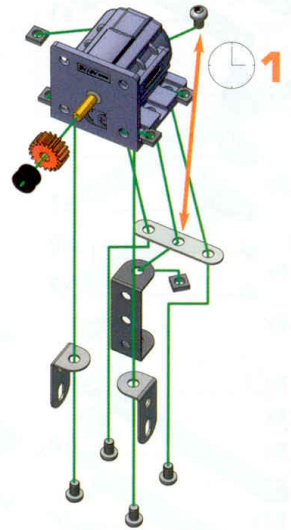
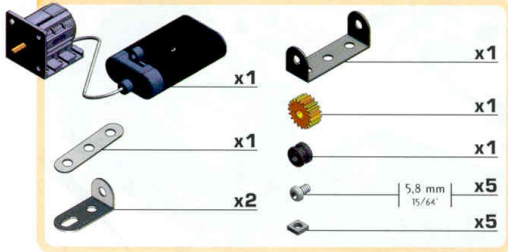

8

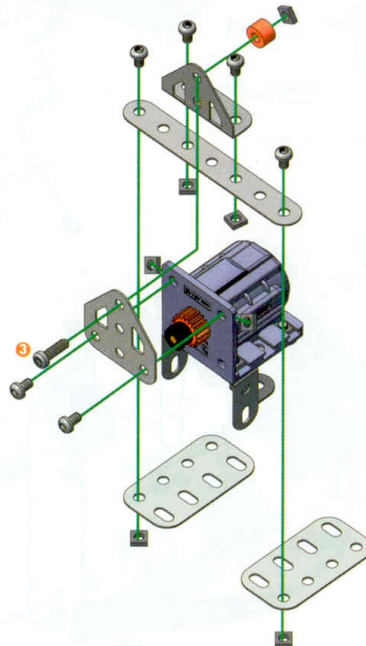
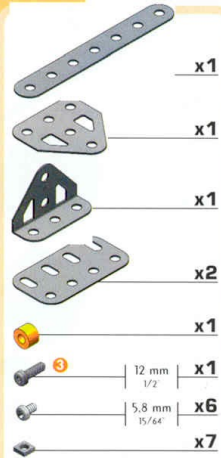



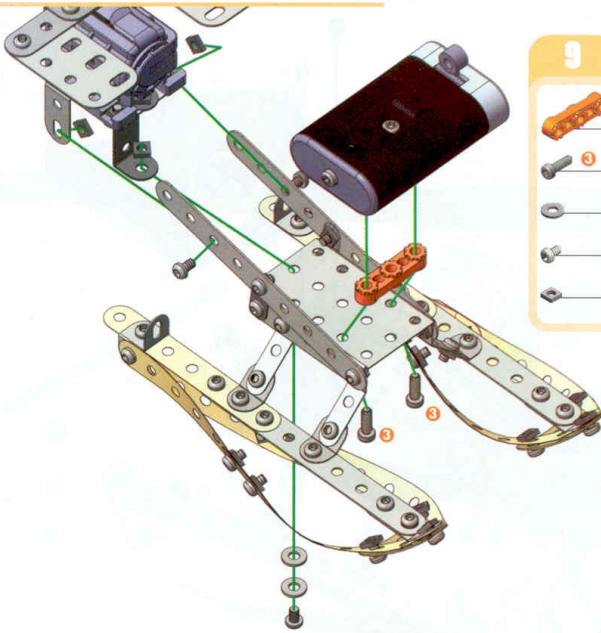

- 9** **6+**
- x1
  - 12 mm | 1/2 x2
  - 5,8 mm | 15/64 x3
  - 5,8 mm | 15/64 x3

- 10**
- x1
  - x1
  - x1
  - x1
  - x1
  - 32 mm | 10 x1
  - x1
  - x2
  - x1
  - 5,8 mm | 15/64 x2
  - 5,8 mm | 15/64 x2

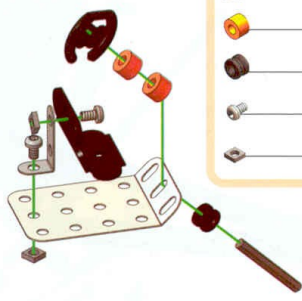

- 11**
- x2
  - x1
  - x4
  - x2
  - x2
  - 12 mm | 1/2 x2
  - 5,8 mm | 15/64 x6
  - 5,8 mm | 15/64 x8

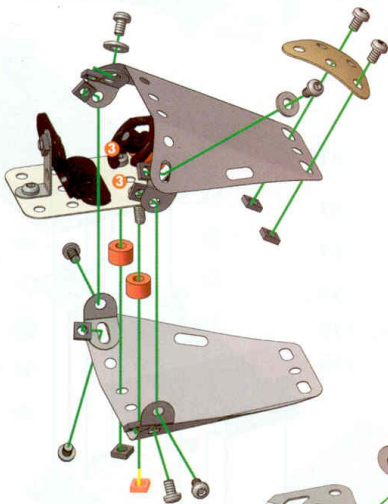

- 12**
- 2
  - 2
  - x2
  - 5,8 mm | 15/64 x5
  - 5,8 mm | 15/64 x5

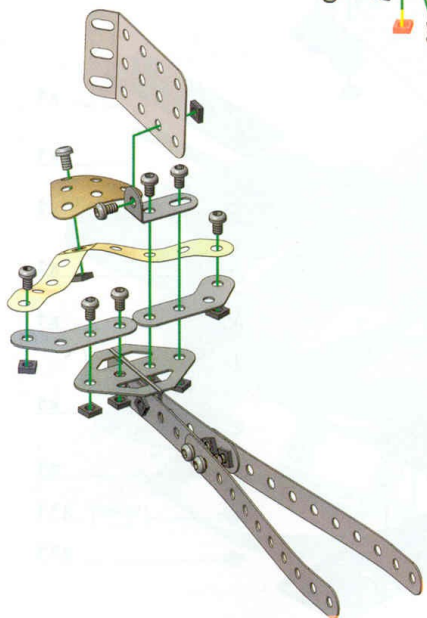
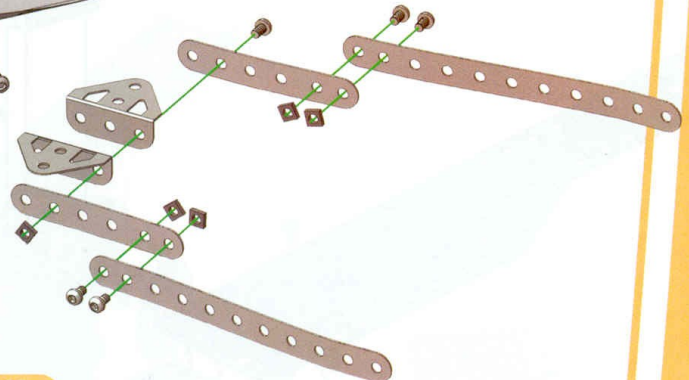

- 13**
- x2
  - x1
  - x1
  - x1
  - 5,8 mm | 15/64 x8
  - 5,8 mm | 15/64 x8

14

9 + 11 +

5,8 mm | 15/64 | x4  
 x4

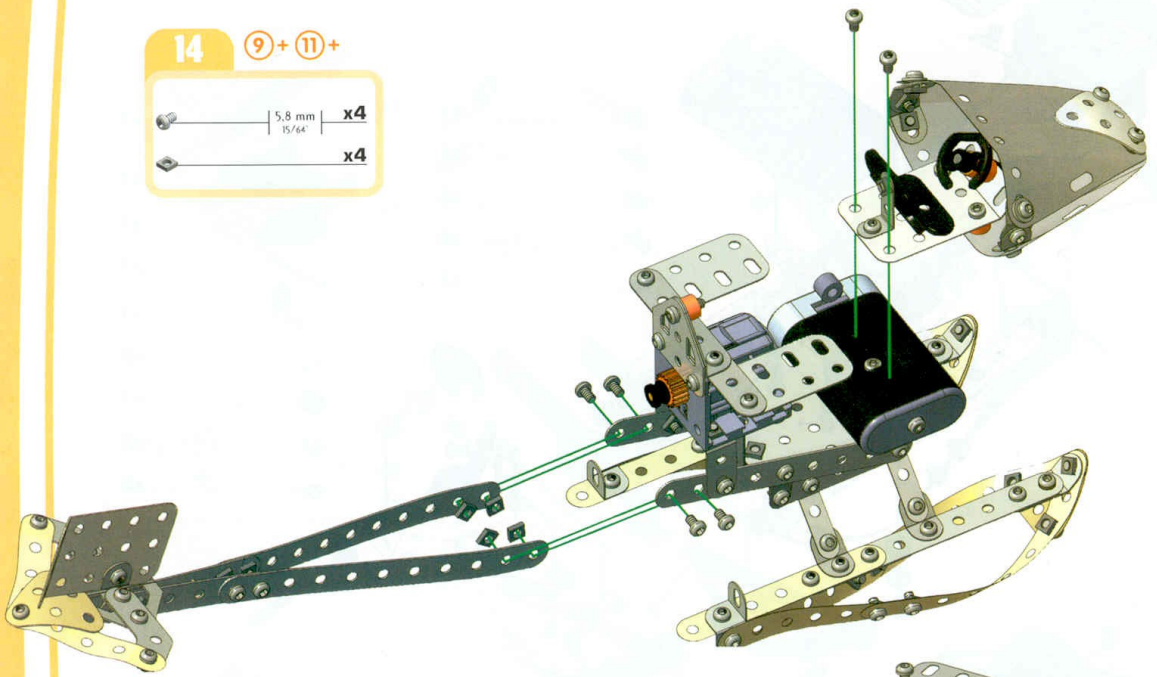

15

x1  
 x1  
 x1  
 x1  
 x1  
 x1  
 x1  
 5,8 mm | 15/64 | x10  
 x10

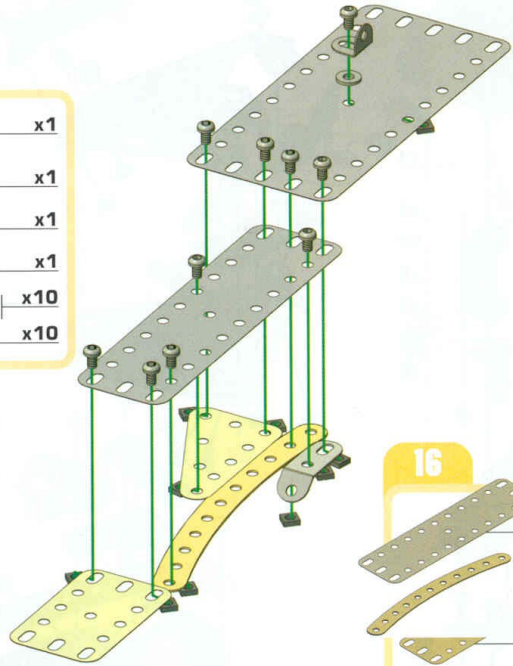

16

x1  
 x1  
 x1  
 x1  
 x1  
 x1  
 x1  
 x1  
 5,8 mm | 15/64 | x11  
 x11

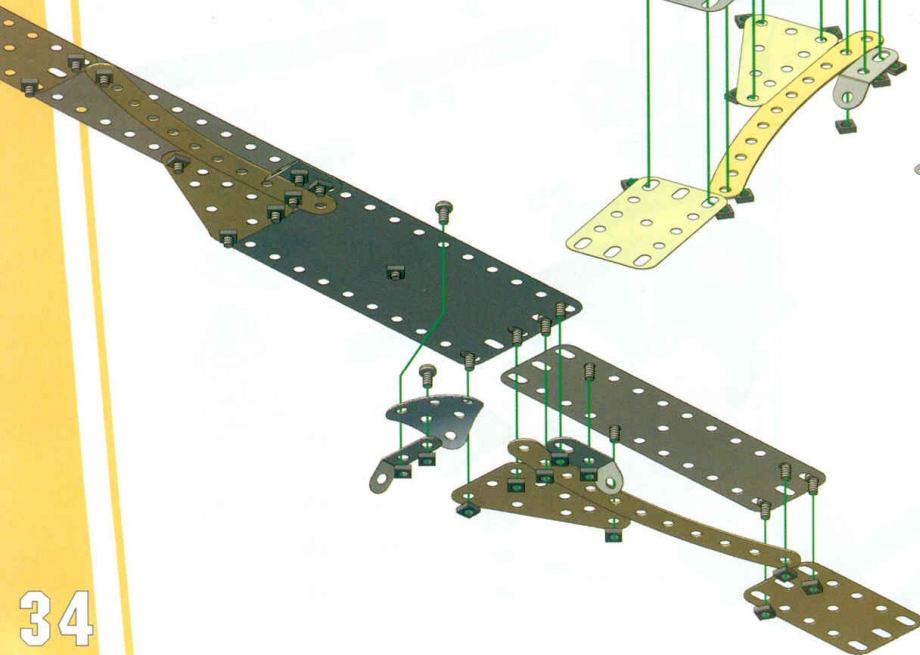











17

(14) +

-  130 mm  $\frac{5}{16}$ " x2
-  x4
-  5,8 mm  $\frac{15}{64}$ " x2
-  x2

18

-  90 mm  $\frac{3}{16}$ " x1
-  x1
-  x1
-  x2
-  x2
-  x2
-  x2
-  5,8 mm  $\frac{15}{64}$ " x2
-  x2

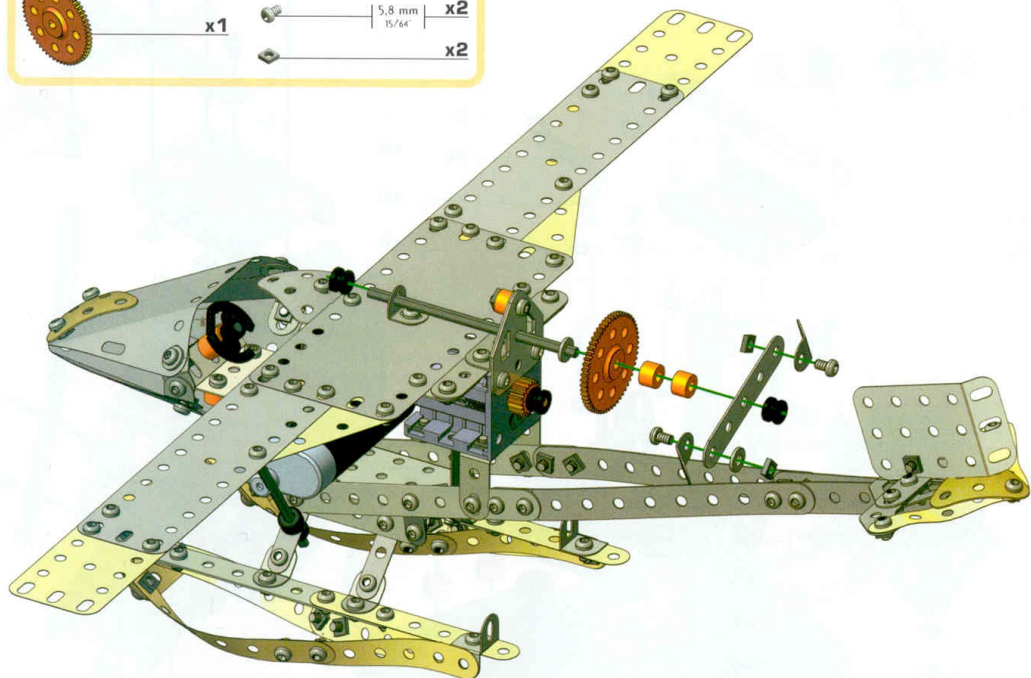

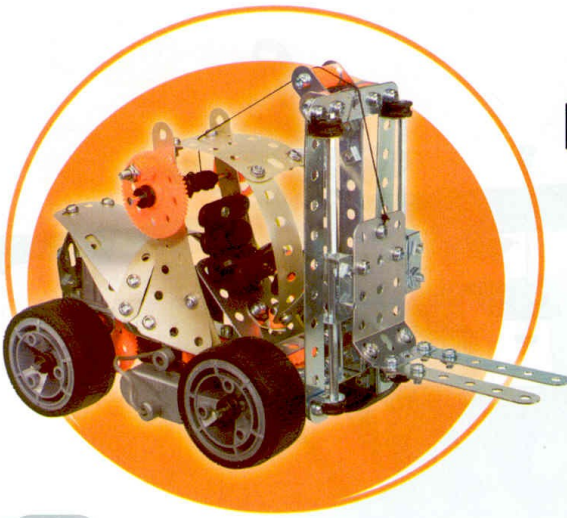

**1**

	x1		x2
	x1		x1
	x2		x1
	x2		x4
			x4

**5**

**2**

	x1		x1
	x3		x6
			x6

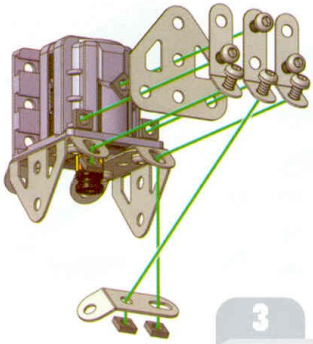

**3**

	x2		x2
	x1		x6
			x6

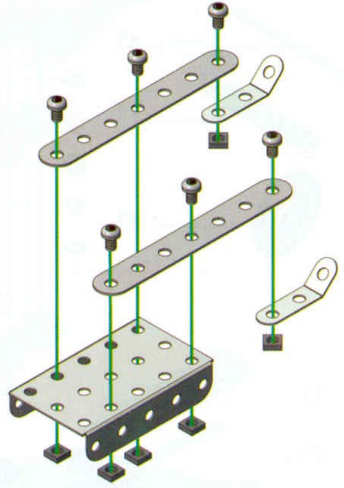





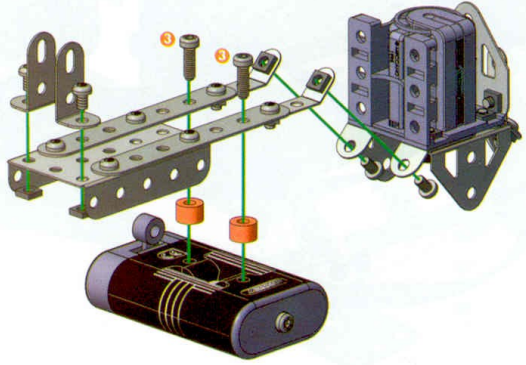







**4**    ② + ③ +





	x2
	x2
	x2
	x4
	x4



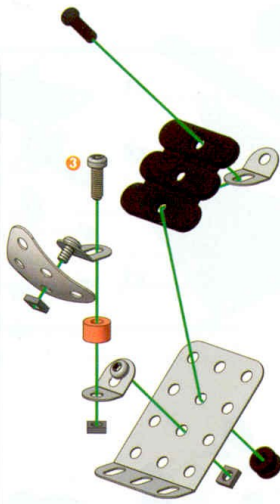





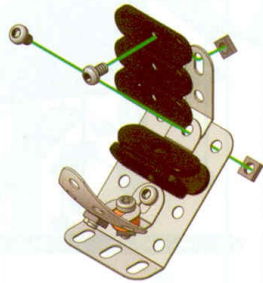

**5**

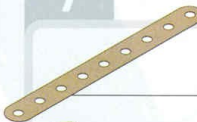
-  x1
-  x1
-  x1
-  x3
-  x1
-  x1
-  x1
-  x1
-  x1
-  x1
-  x2
-  x3





**6**

-  x1
-  5,8 mm 15/64 x2
-  x1
-  x2

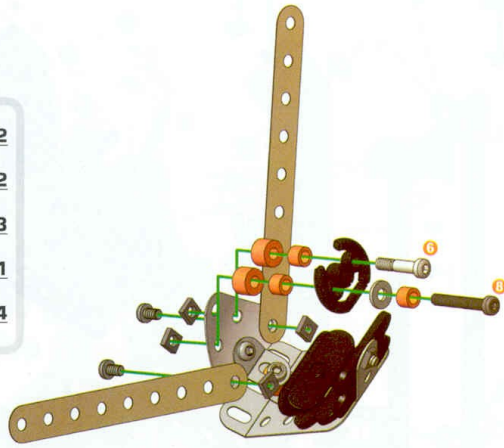
**7**

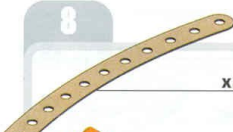
-  x2
-  5,8 mm 15/64 x2
-  x2
-  x3
-  25,4 mm 1 x1
-  19,2 mm 3/4 x1
-  x1
-  x4

**8**

-  x2
-  12 mm 1/2 x2
-  5,8 mm 15/64 x2
-  x1
-  x4

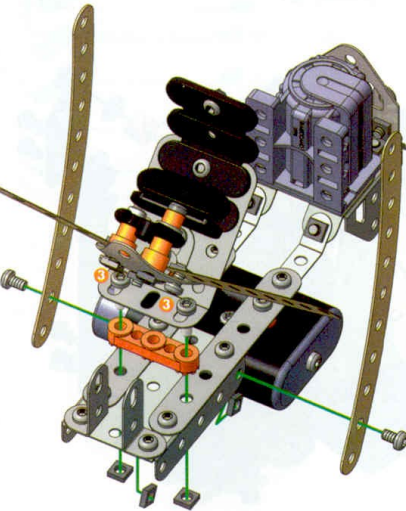
**9**

-  x1
-  x2
-  5,8 mm 15/64 x7
-  x7

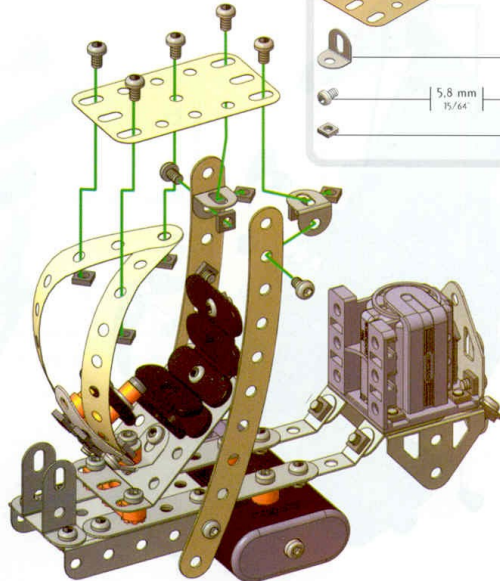

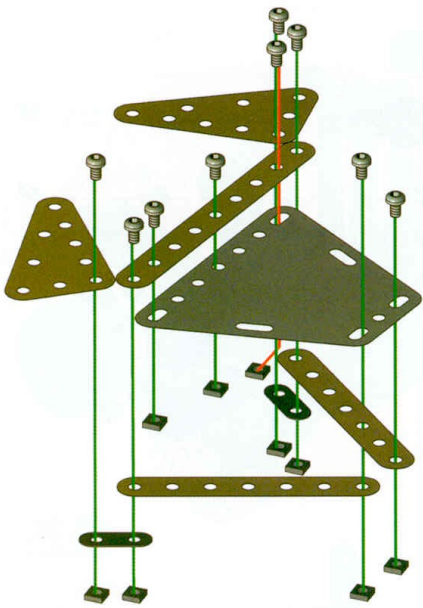

**10**

- x1 [Long thin plate]
- x2 [Triangular plate]
- x2 [Thin plate]
- x2 [Small pin]
- x1 [Large triangular plate]
- x9 [5,8 mm / 15/64 pin]
- x9 [Small pin]

**11** **9+**

- x2 [5,8 mm / 15/64 pin]
- x2 [Small pin]

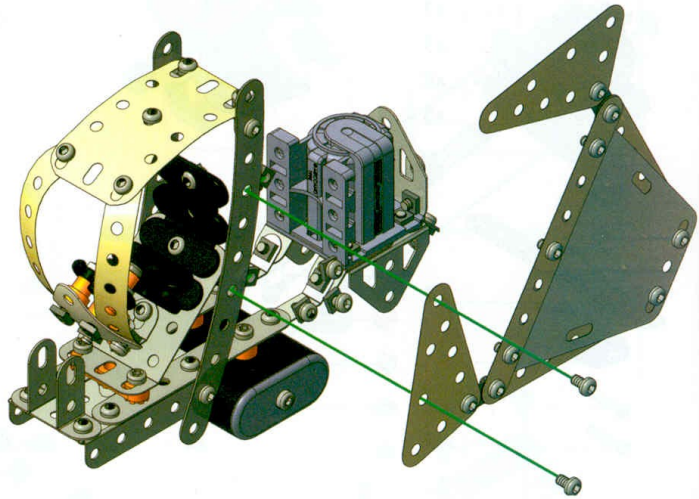

**12**

- x2 [5,8 mm / 15/64 pin]
- x2 [Small pin]

**13**

- x2 [Long thin plate]
- x2 [L-shaped plate]
- x3 [5,8 mm / 15/64 pin]
- x3 [Yellow bush]
- x1 [Washer]
- x1 [8 mm / 25,4 mm screw]
- x9 [Small pin]

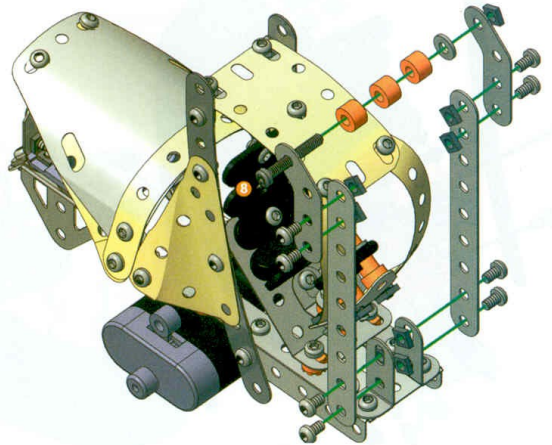
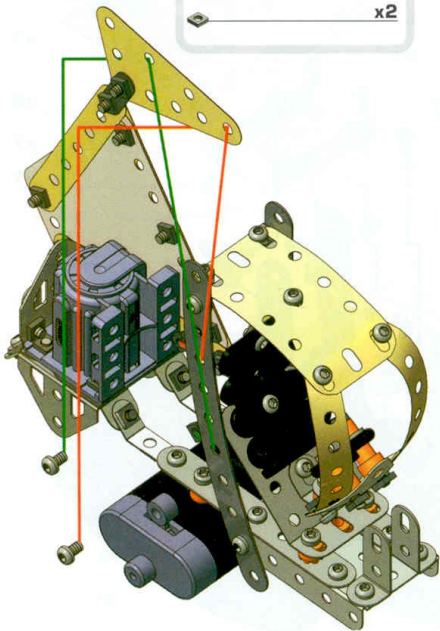

14

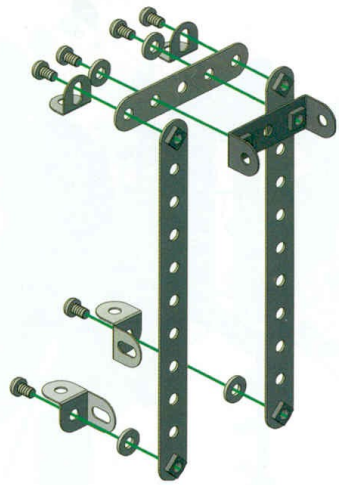
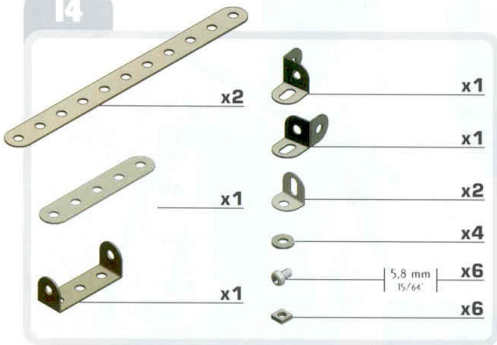

15

13 + 14 +

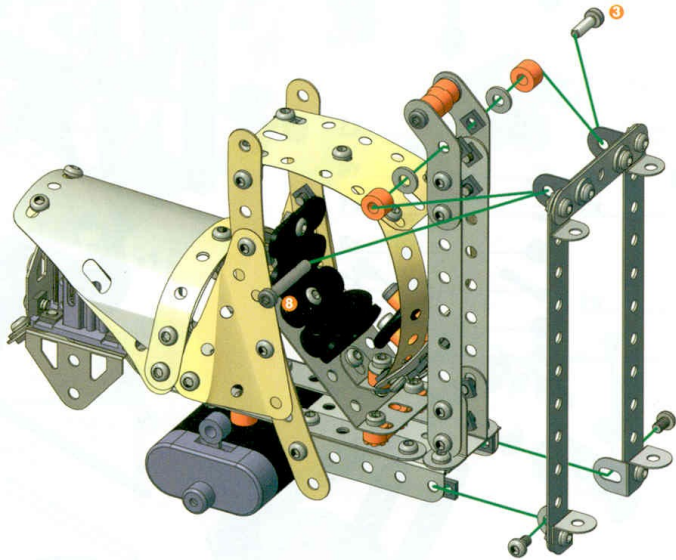
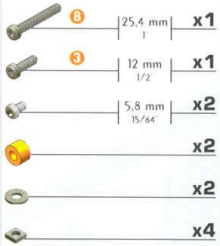

16

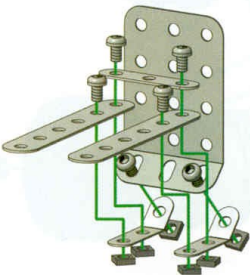
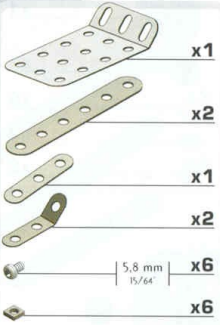

17

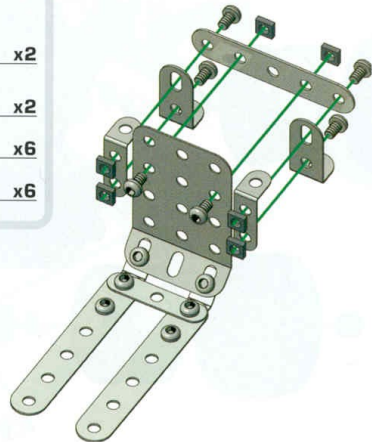
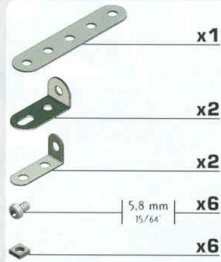

18

15 + 17 +

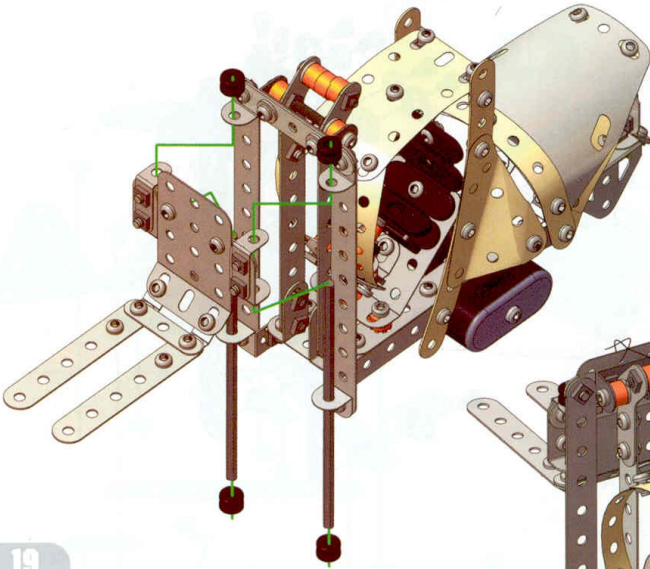

19

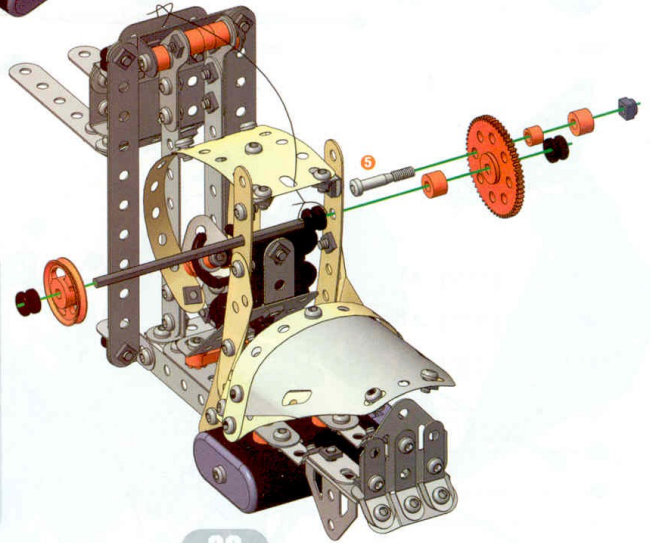
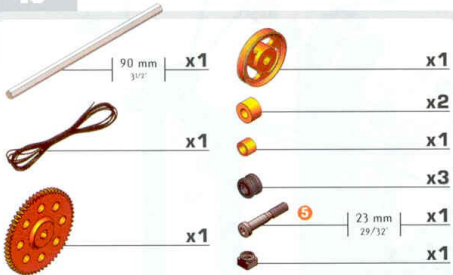

20

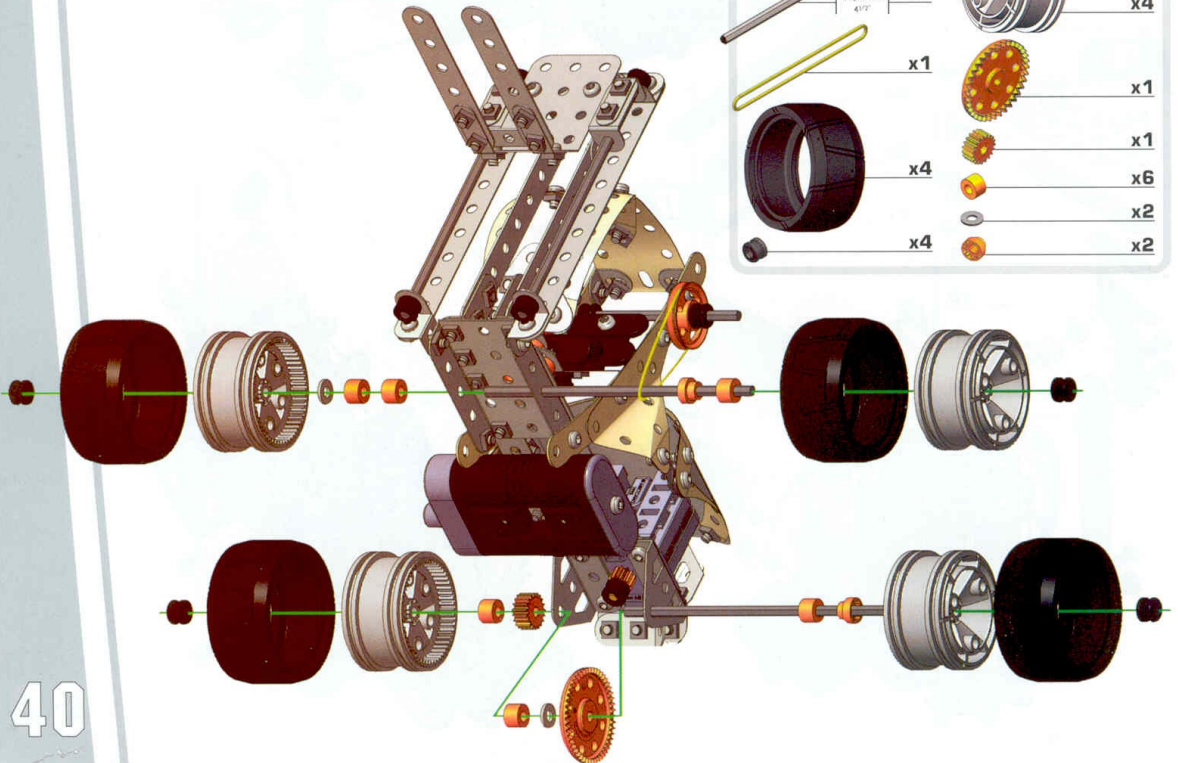
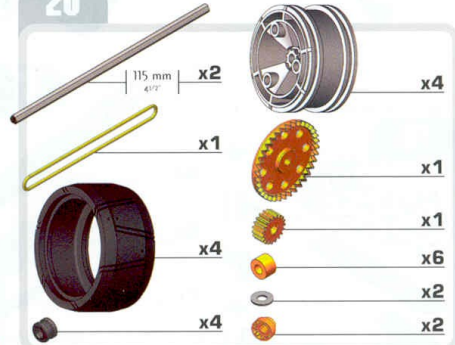



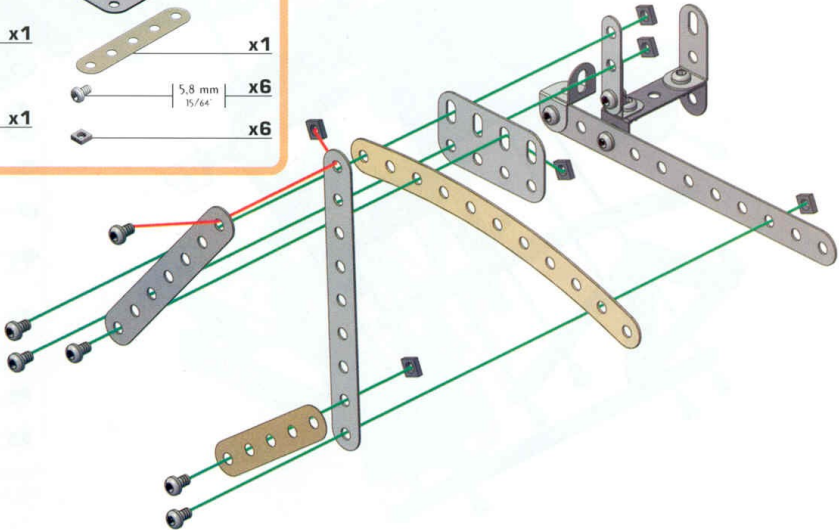
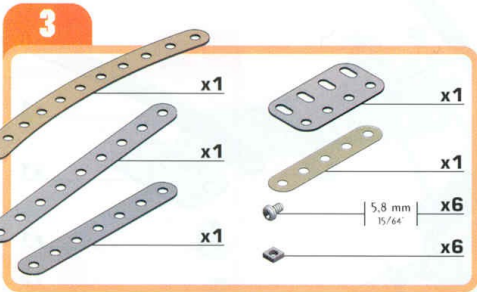
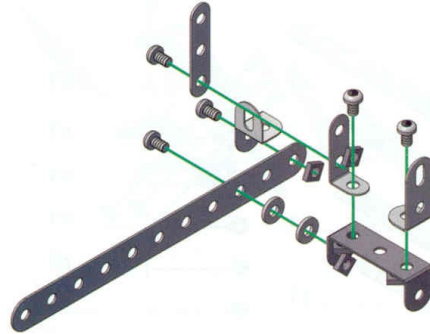
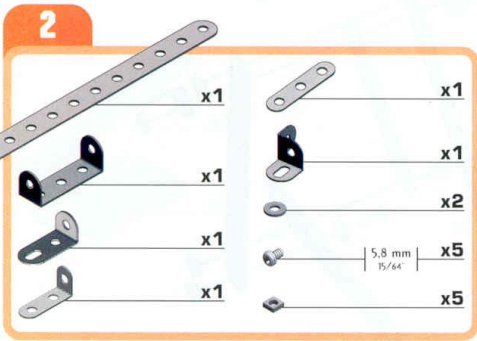
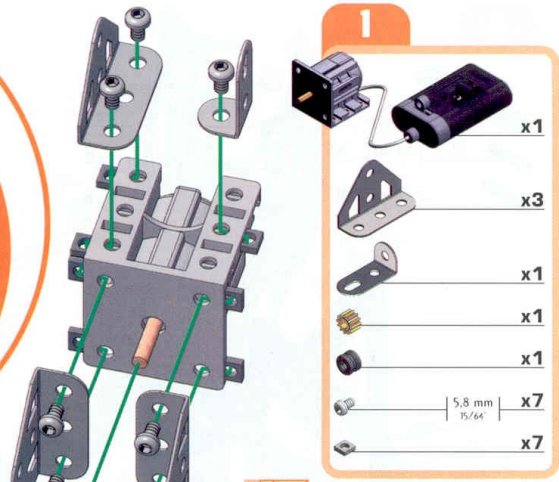
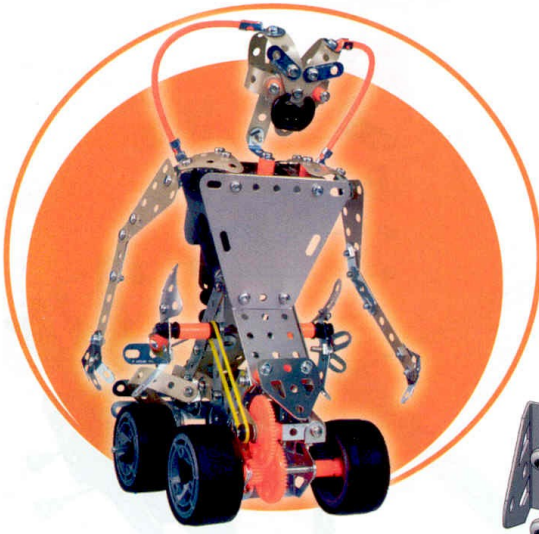

4

- |  |                 |  |    |
|--|-----------------|--|----|
|  | x1              |  | x4 |
|  | 19,2 mm<br>3/4" |  | x1 |
|  | 23 mm<br>29/32" |  | x2 |
|  |                 |  | x4 |

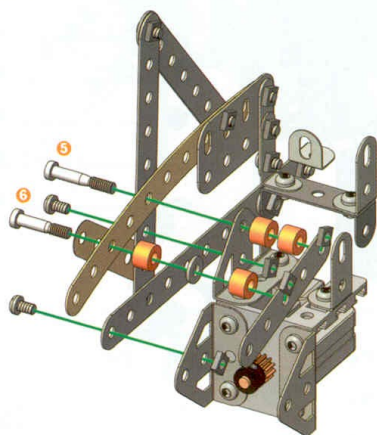

5

- |  |    |
|--|----|
|  | x1 |
|  | x1 |
|  | x3 |
|  | x3 |

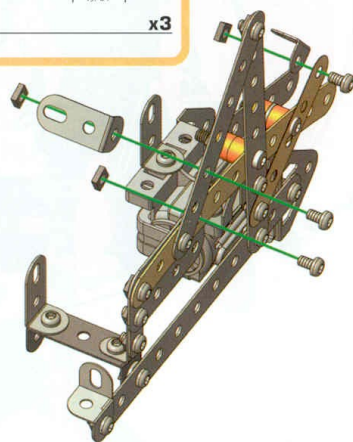

6

- |  |    |  |    |
|--|----|--|----|
|  | x1 |  | x1 |
|  | x1 |  | x1 |
|  | x1 |  | x1 |
|  | x1 |  | x1 |
|  | x1 |  | x5 |
|  |    |  | x5 |

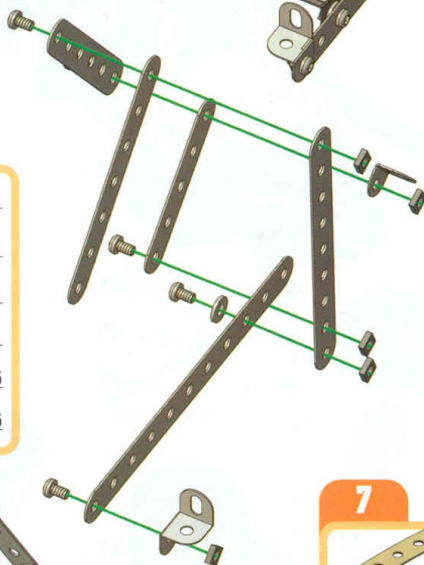

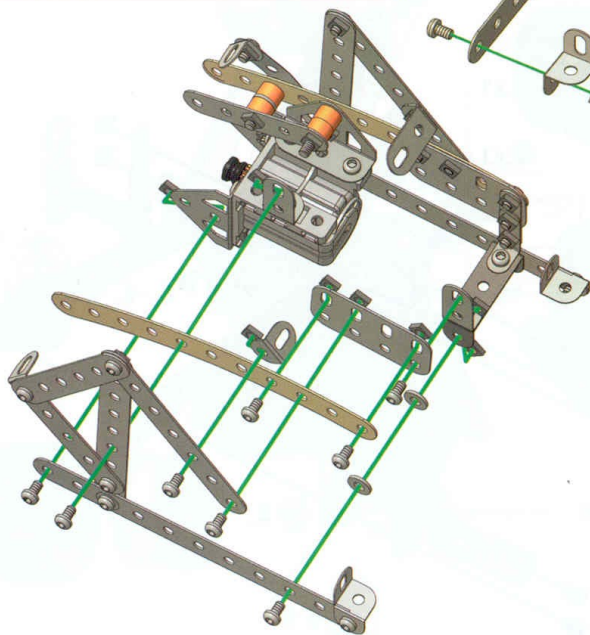

7

- |  |    |
|--|----|
|  | x1 |
|  | x1 |
|  | x1 |
|  | x2 |
|  | x8 |
|  | x8 |



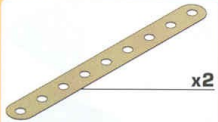
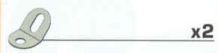

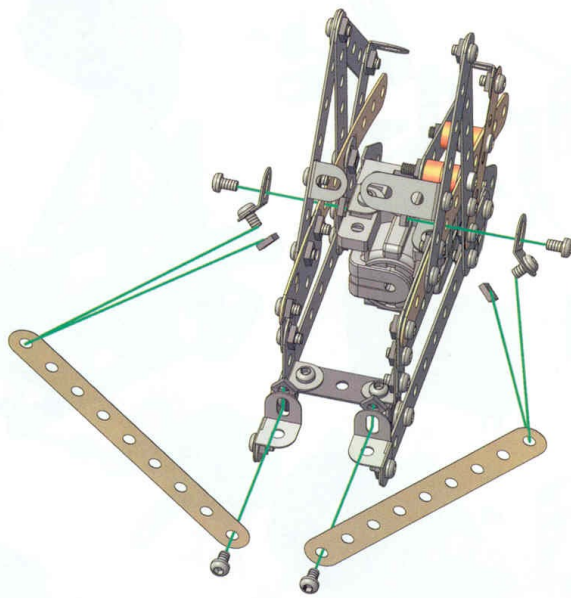

8

-  x2
-  x2
-  x6
-  x6

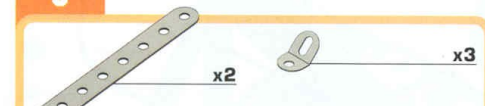

9

-  x2
-  x3
-  x6
-  x1
-  x6

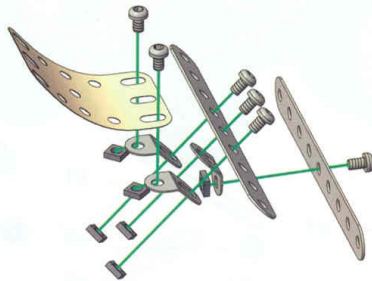





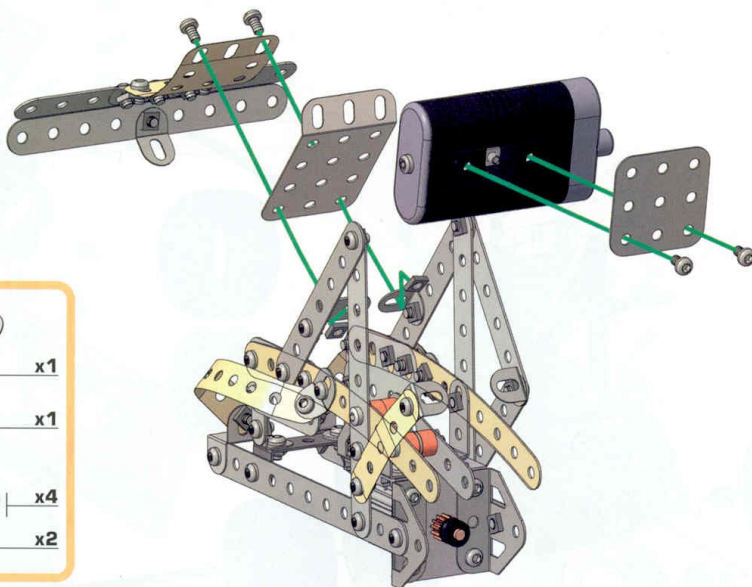

10







-  x1
-  x1
-  x4
-  x2

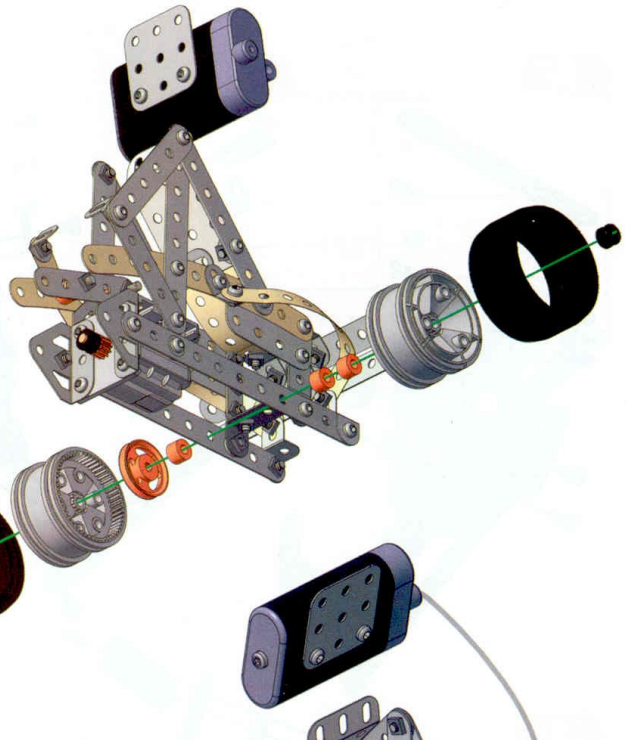









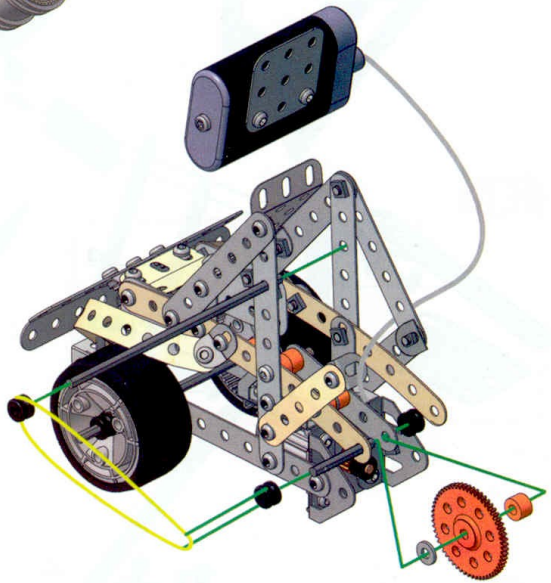

**11**

-  130 mm  $\frac{5}{16}$ " x1
-  x2
-  x2
-  x1
-  x2
-  x3

**12**





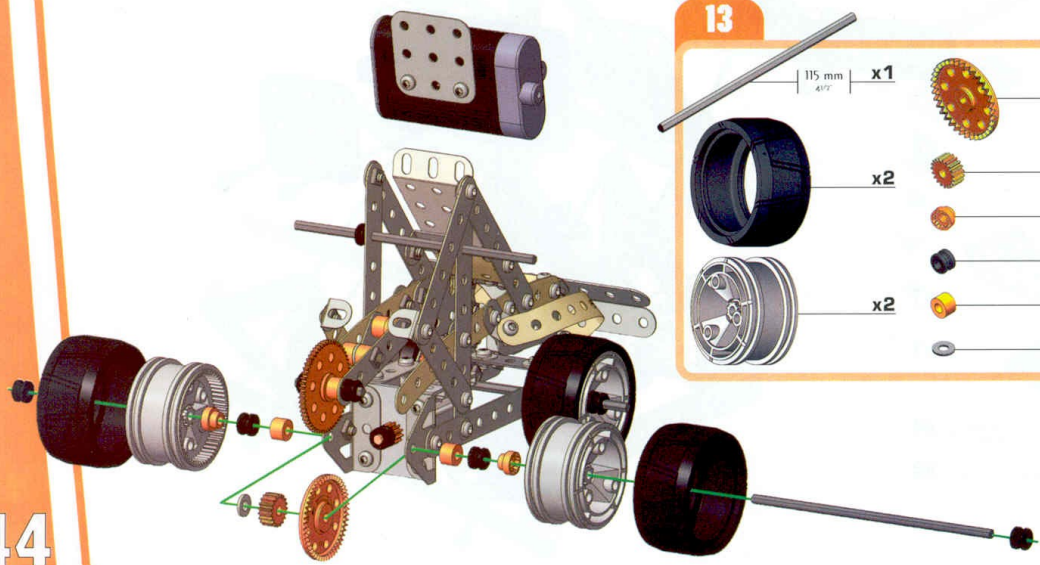

-  115 mm  $\frac{4}{16}$ " x1
-  x1
-  32 mm  $\frac{1}{4}$ " x1
-  x3
-  x1
-  x1
-  x1

**13**

-  115 mm  $\frac{4}{16}$ " x1
-  x2
-  x2
-  x1
-  x1
-  x2
-  x4
-  x2
-  x1







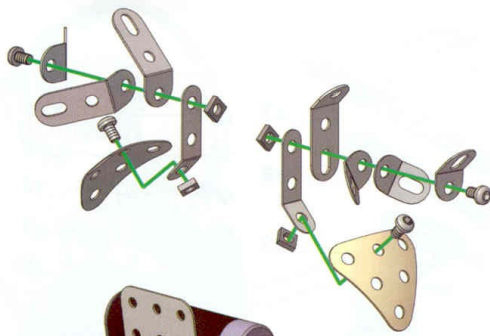



# 14

-  x1
-  x1
-  x3
-  x4
-  x2
-  5,8 mm 15/64 x4
-  x4







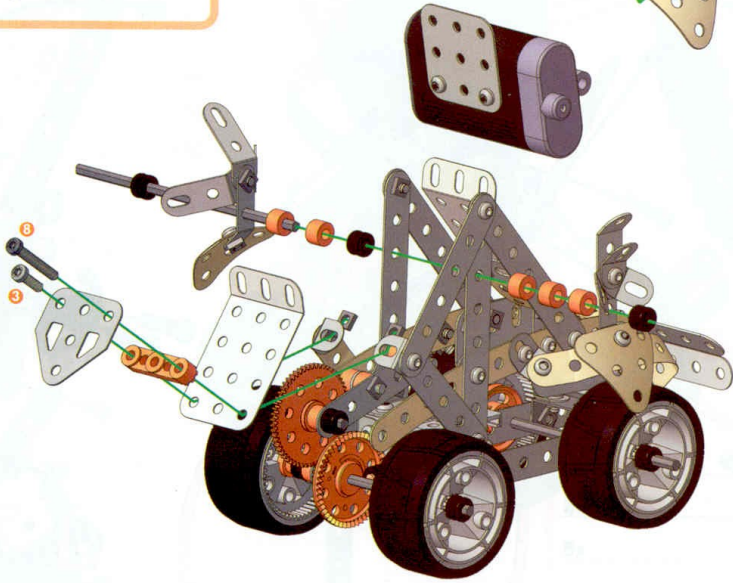

# 15

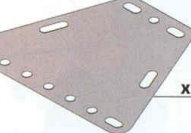
-  x1
-  x1
-  x1
-  25,4 mm x1
-  12 mm 1/2 x1
-  x5
-  x2
-  x2







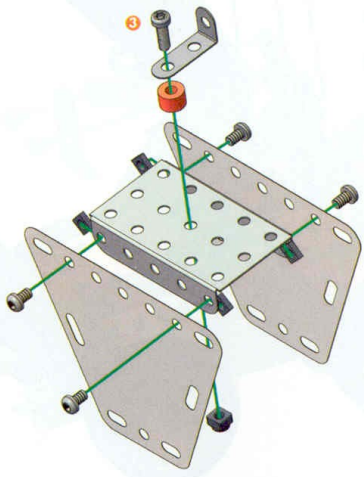

# 16

-  x1
-  x2
-  x1
-  x1
-  x1
-  12 mm 1/2 x1
-  5,8 mm 15/64 x4
-  x4



# 17

-  x2
-  x2
-  x2
-  x2
-  12 mm 1/2 x2
-  5,8 mm 15/64 x4
-  x6

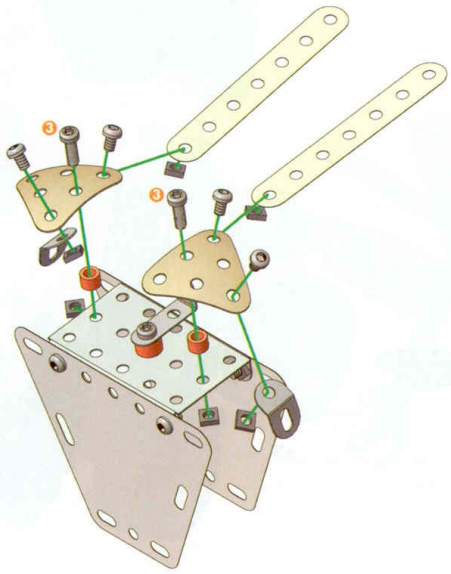

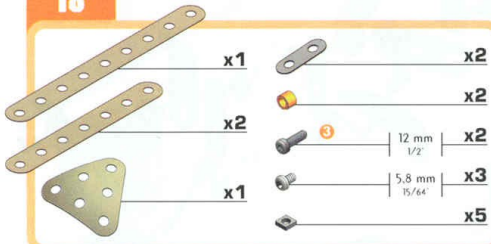
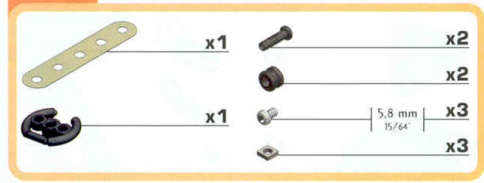
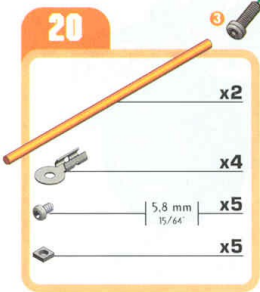
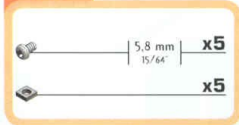
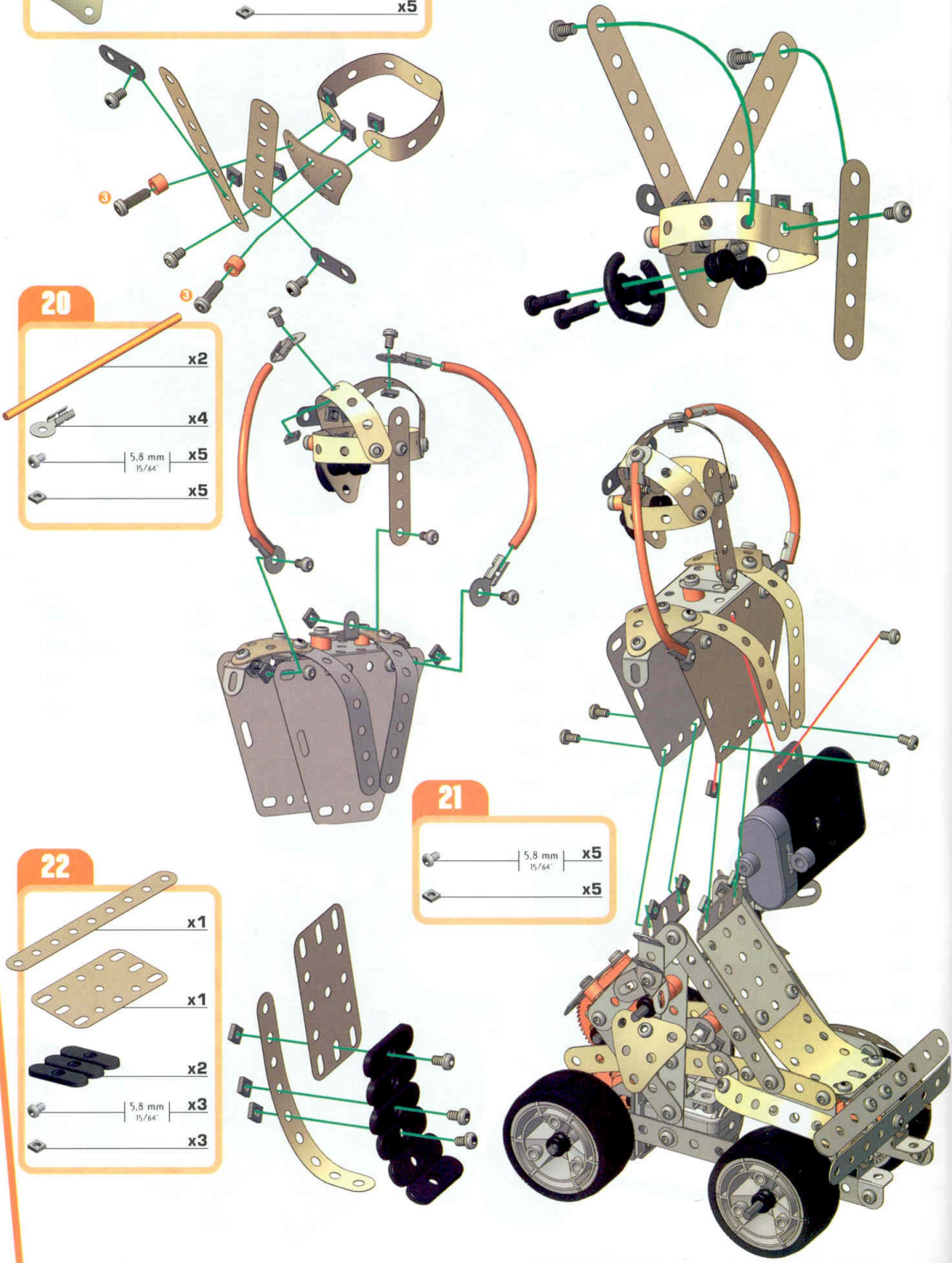
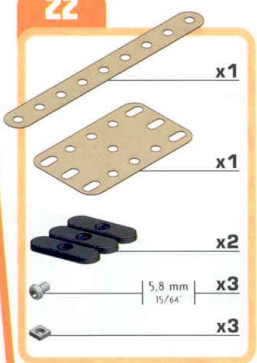
**18****19****20****21****22**

23 22+

- 5,8 mm 15/64 x3
- x1

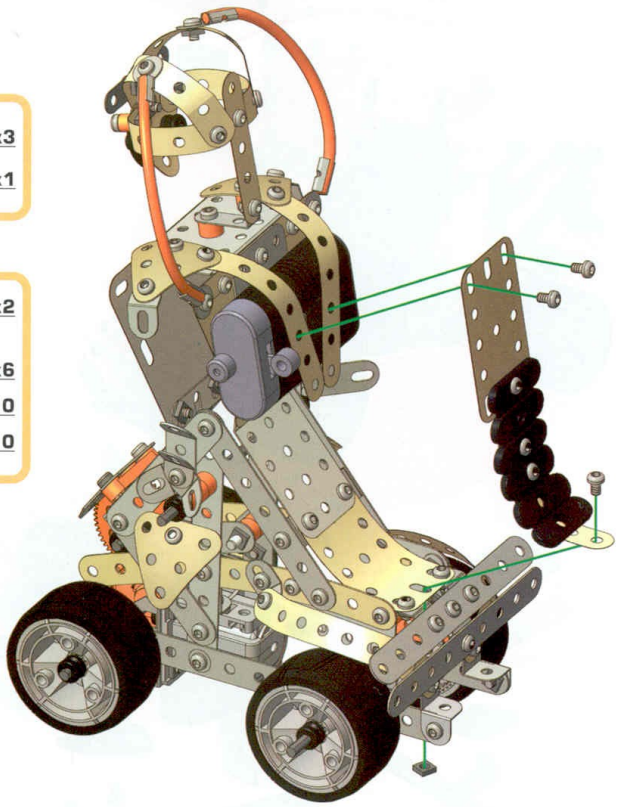

24

- x2
- x2
- x6
- 5,8 mm 15/64 x10
- x10

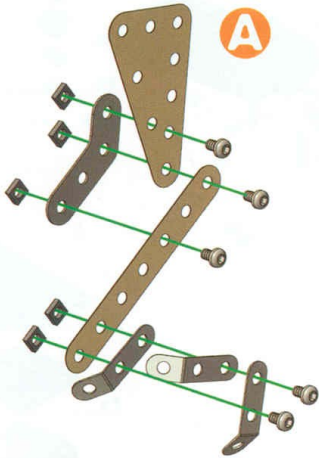

A

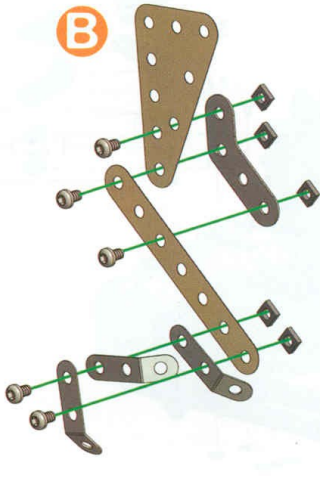

B

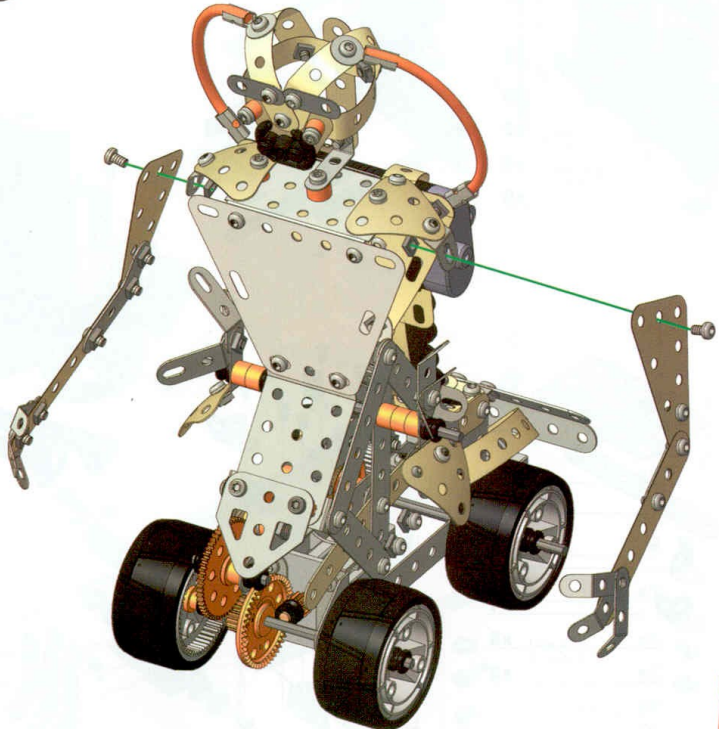





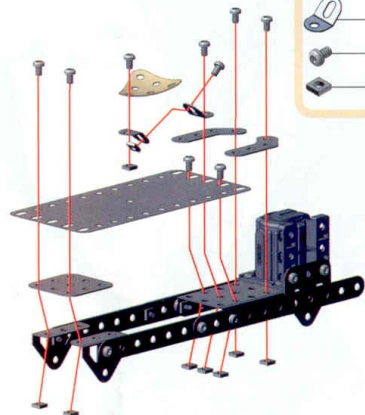
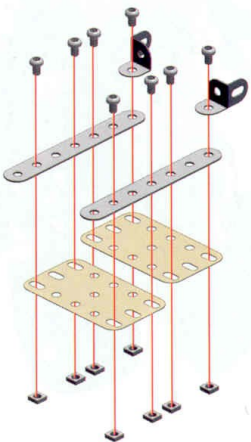
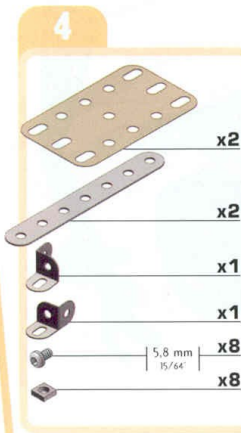
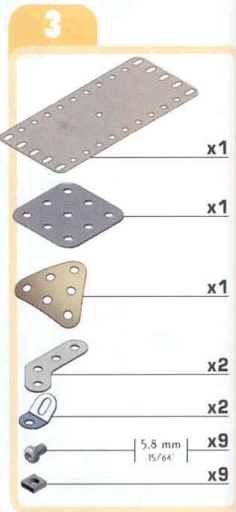
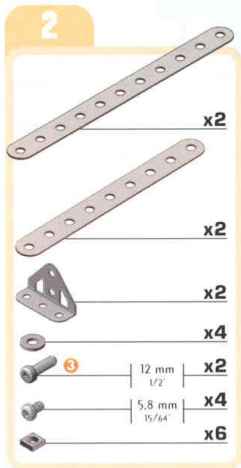
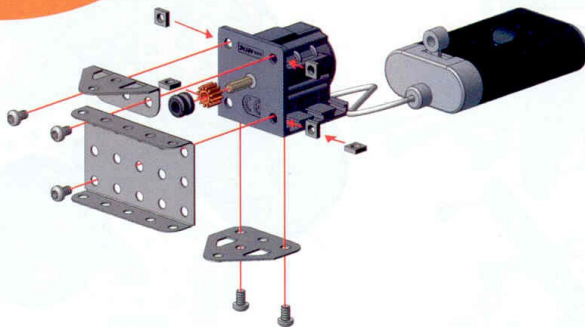
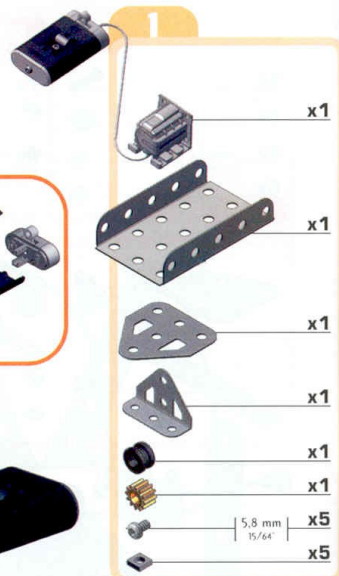
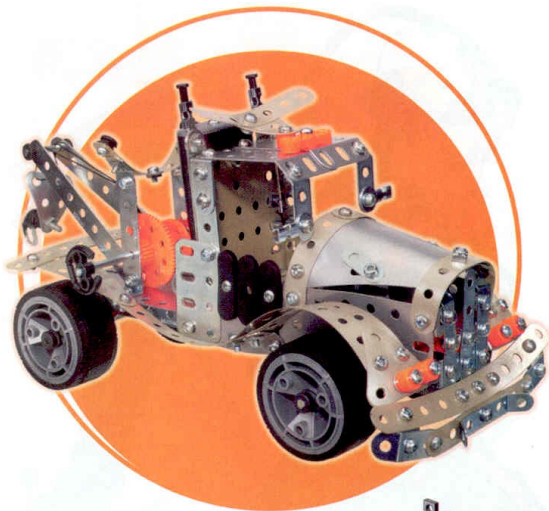

25 24 AB+

- 5,8 mm 15/64 x2
- x2

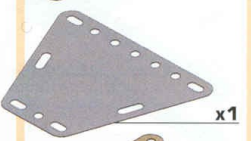



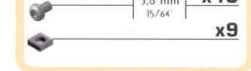



6

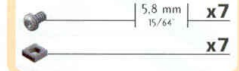

-  x2
-  x1
-  x1
-  x2
-  x2
-  x2
-  x1
-  x10
-  x9

8

-  x1
-  x1
-  x1
-  x1
-  x7
-  x7







5

3 + 4 +





-  x2
-  x5
-  x4

7

5 + 6 +





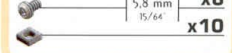

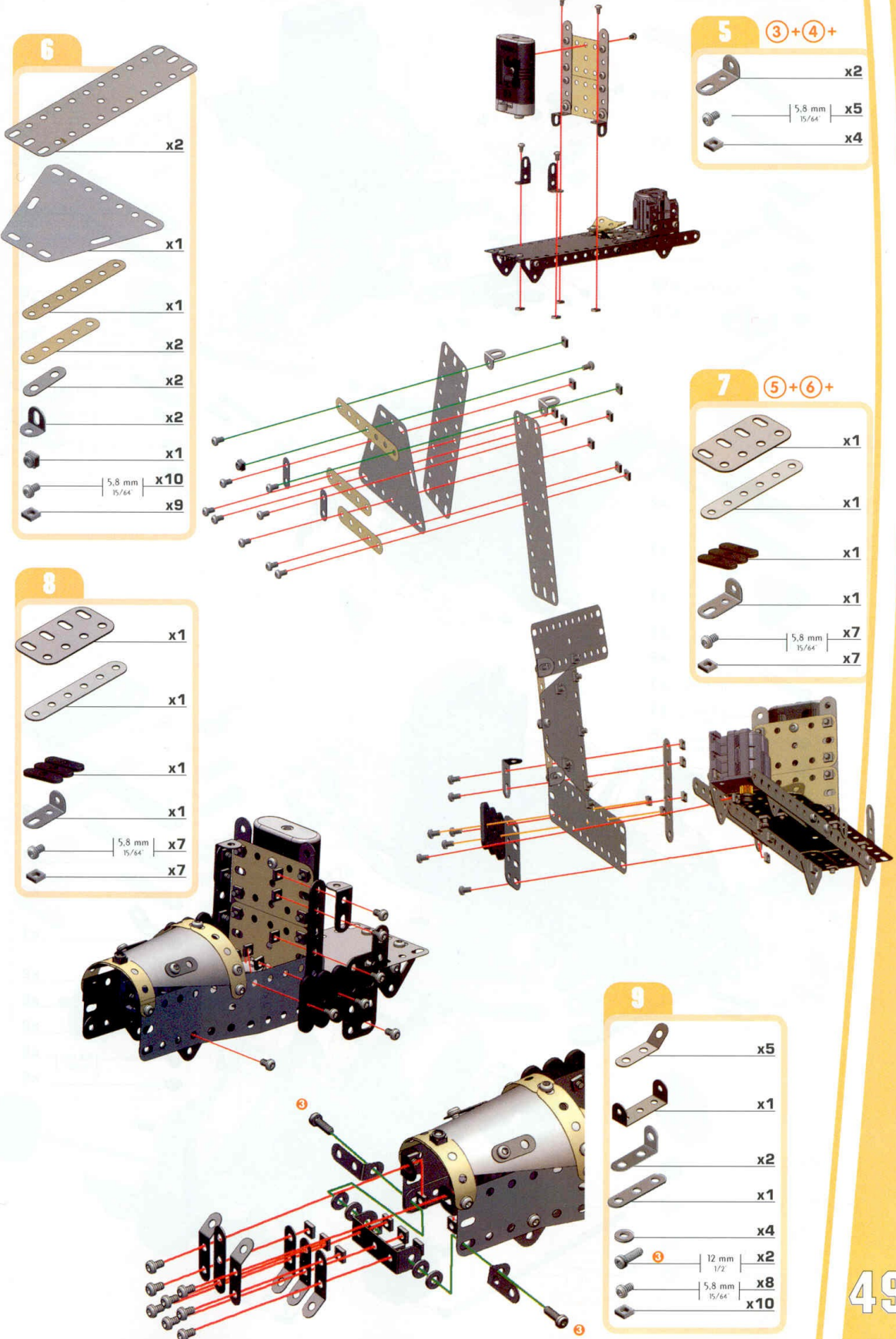
-  x1
-  x1
-  x1
-  x1
-  x7
-  x7

9

-  x5
-  x1
-  x2
-  x1
-  x4
-  x2
-  x8
-  x10







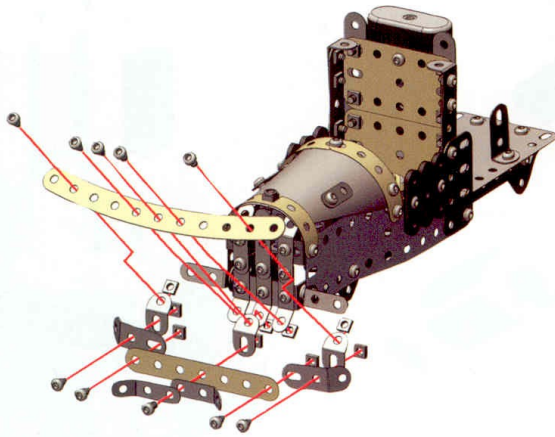



10

-  x1
-  x1
-  x2
-  x2
-  x3
-  | 5,8 mm | 15/64 | x10
-  x10



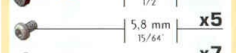
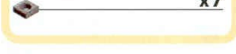



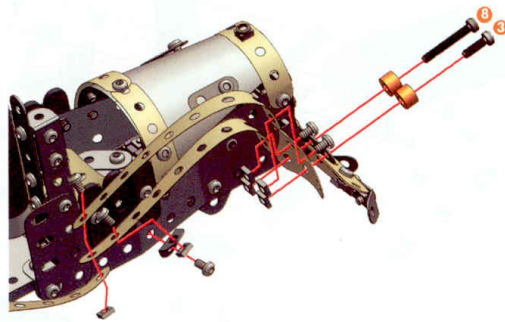



11

-  x2
-  x1
-  x1
-  x1
-  x2
-  x1
-  | 25,4 mm | 1 | x1
-  | 12 mm | 1/2 | x1
-  | 5,8 mm | 15/64 | x5
-  x7







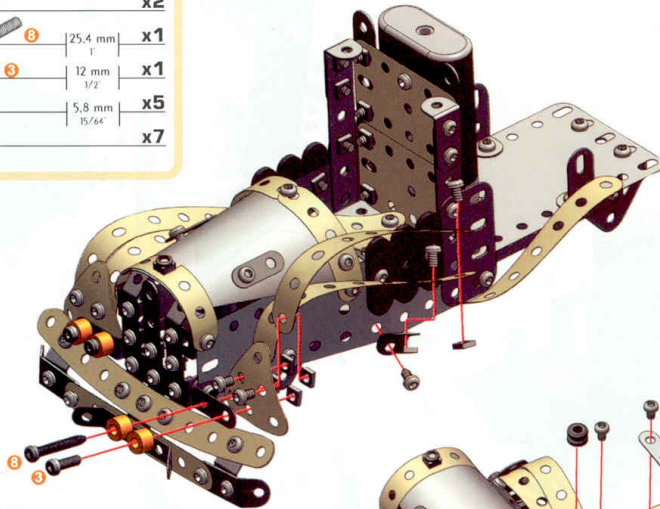



12

-  x2
-  x1
-  x1
-  x1
-  x2
-  | 25,4 mm | 1 | x1
-  | 12 mm | 1/2 | x1
-  | 5,8 mm | 15/64 | x5
-  x7

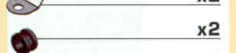

13

-  x2
-  x1
-  x2
-  x1
-  x2
-  x2
-  x2
-  | 5,8 mm | 15/64 | x9
-  x5

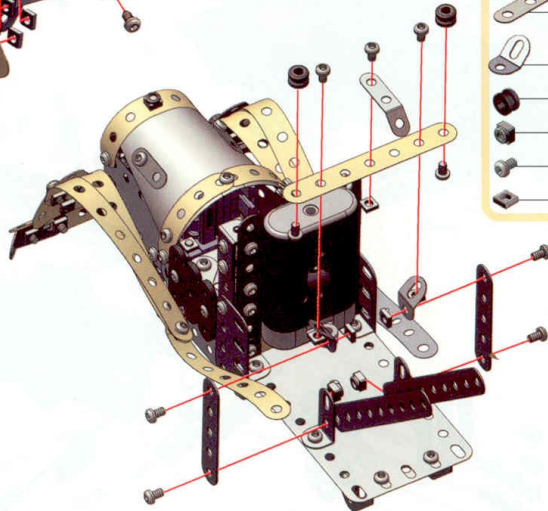

14

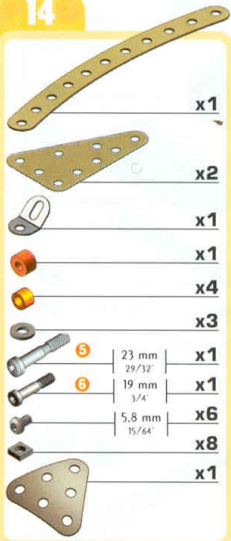

A

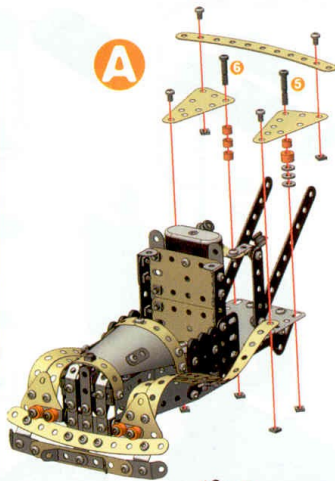

B



15

14+

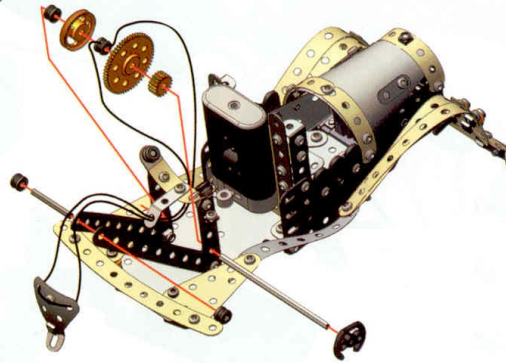
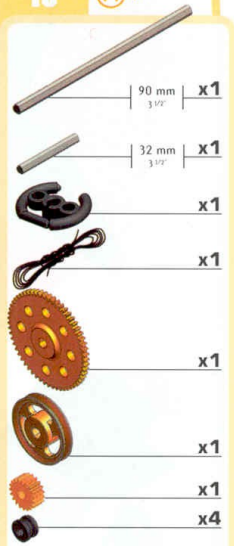

16

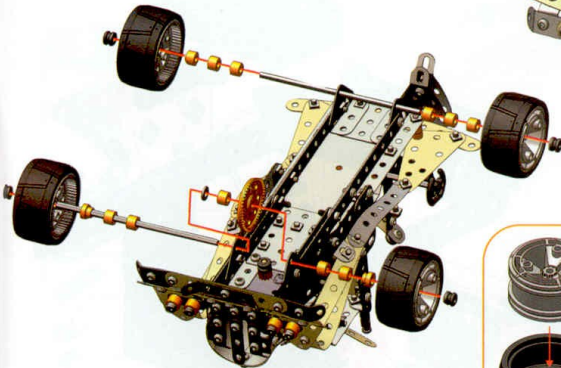
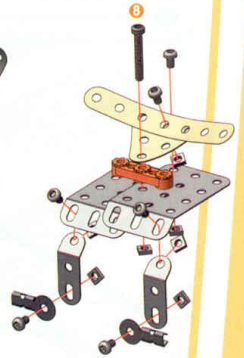
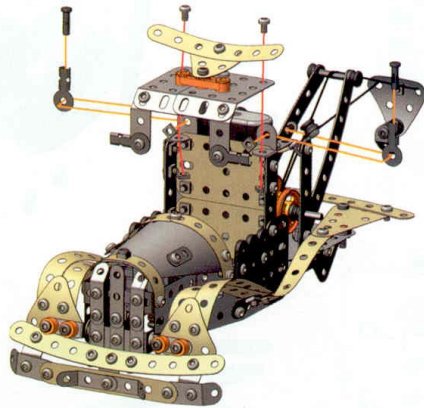
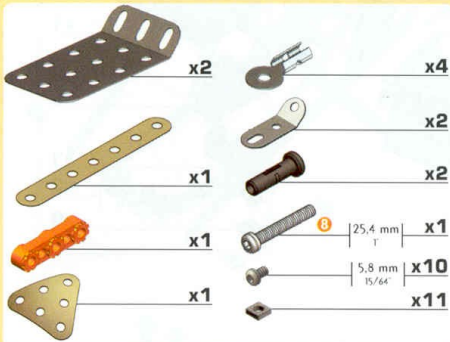

17

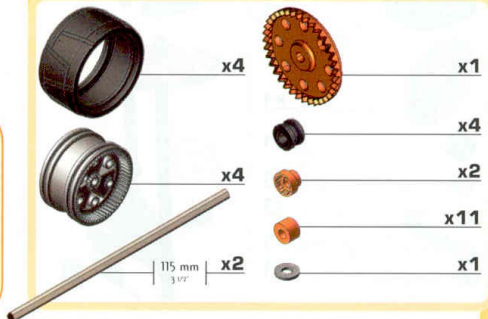

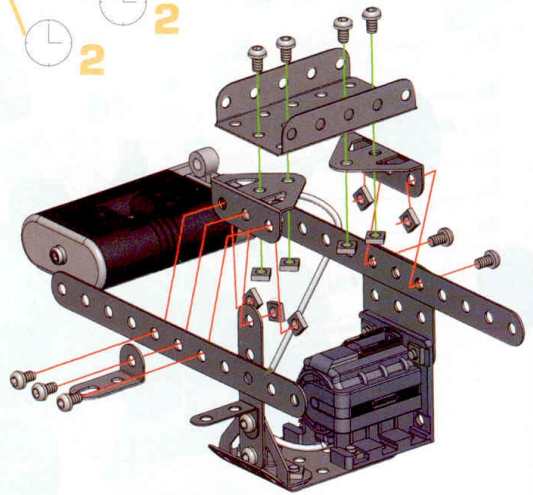
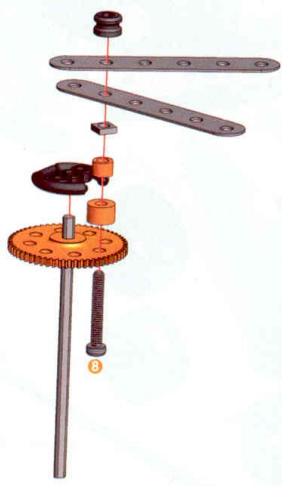
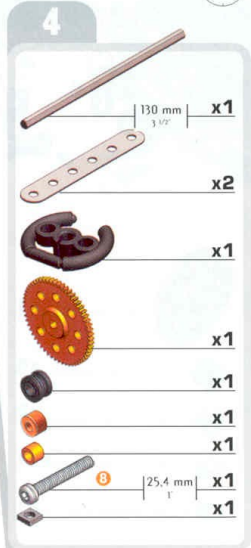
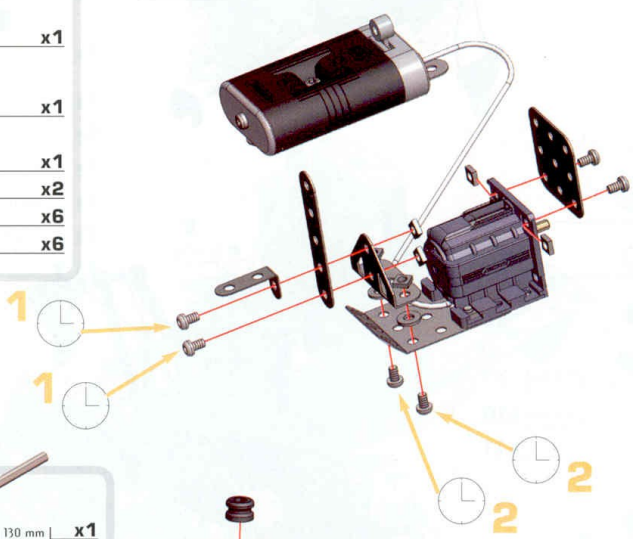
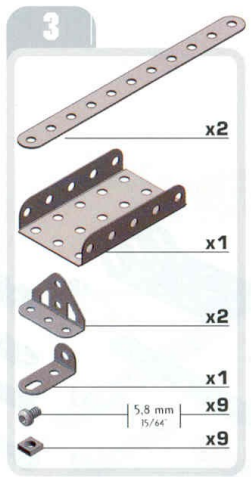
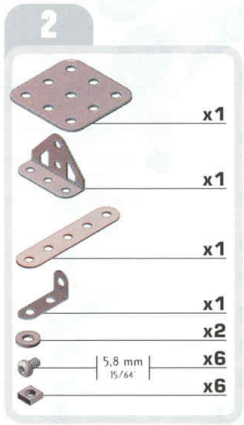
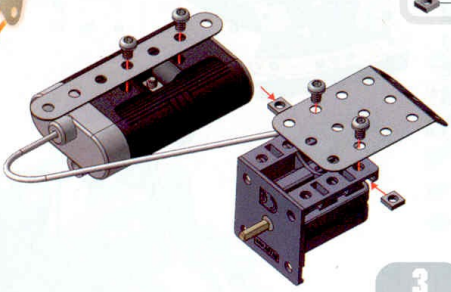
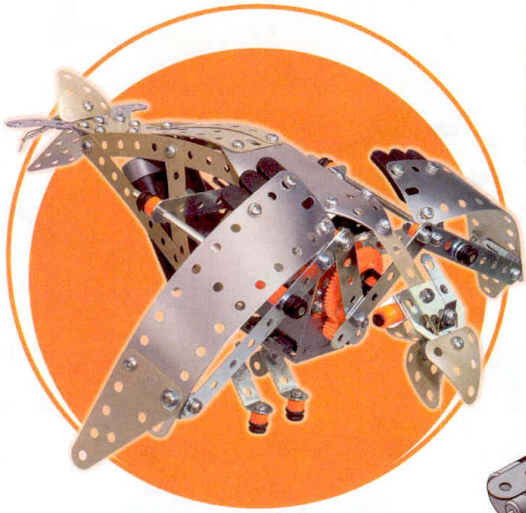



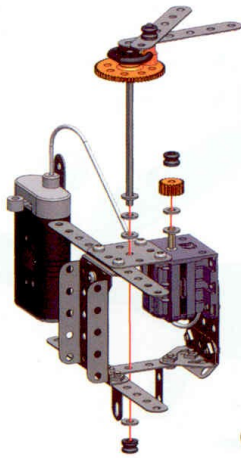

5

(3)+(4)+

-  x2
-  x1
-  x6





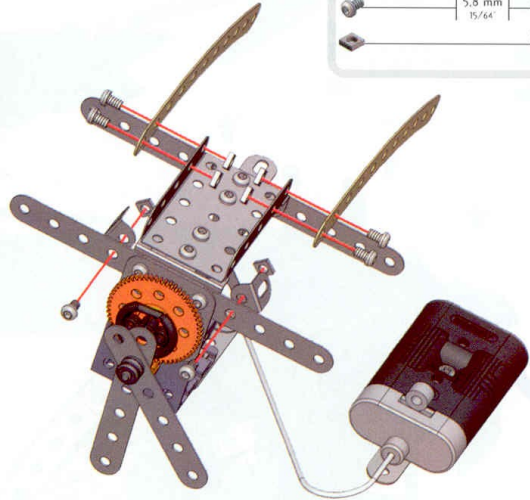

6

-  x2
-  x2
-  | 5,8 mm | x6
-  | 15/64" | x6







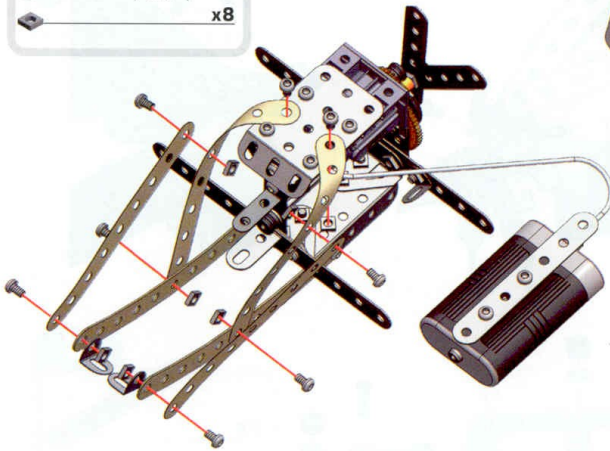

7

-  x4
-  x2
-  | 5,8 mm | x8
-  | 15/64" | x8







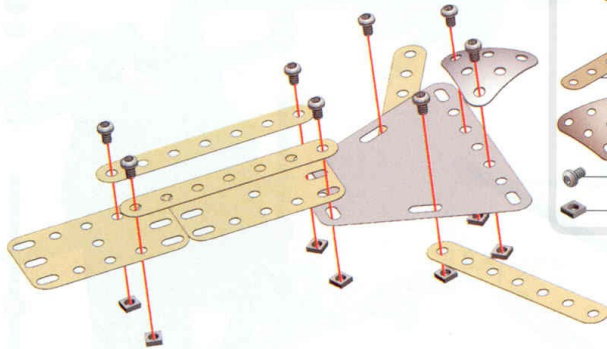

8

-  x1
-  x2
-  x4
-  x1
-  | 5,8 mm | x8
-  | 15/64" | x8





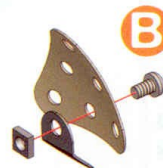
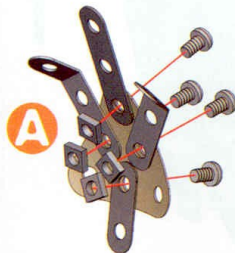

9

-  x2
-  x2
-  x1
-  x1
-  x1
-  | 5,8 mm | x5
-  | 15/64" | x5



10

8 + 9 +

-  x1
-  x1
-  x2
-  x3
-  x3

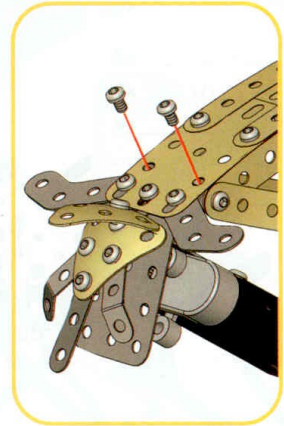
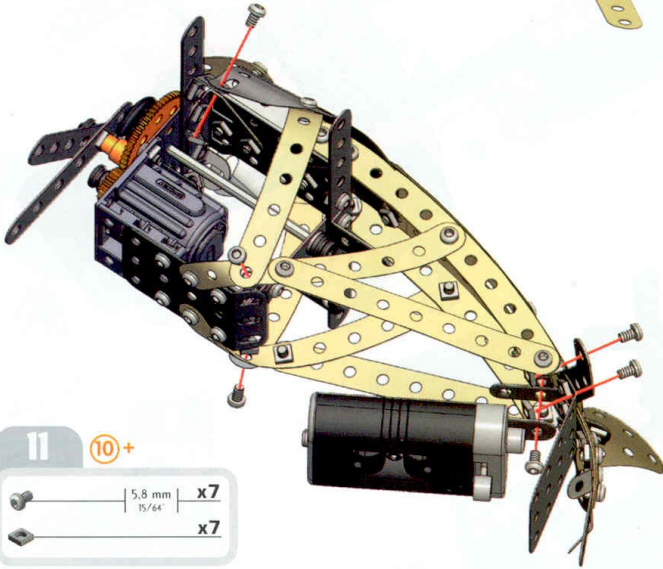
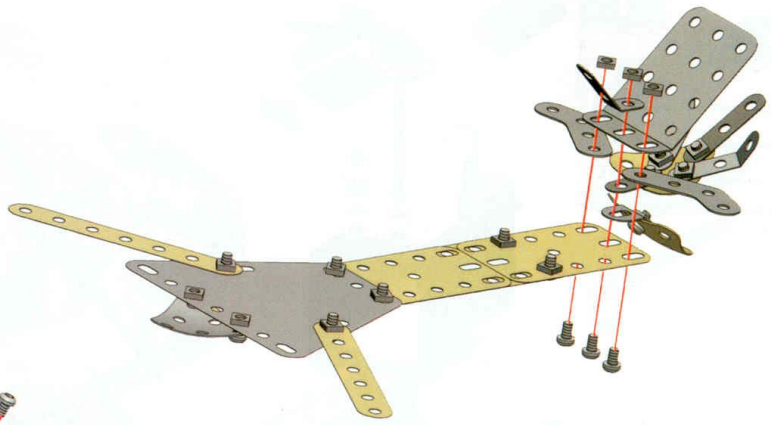





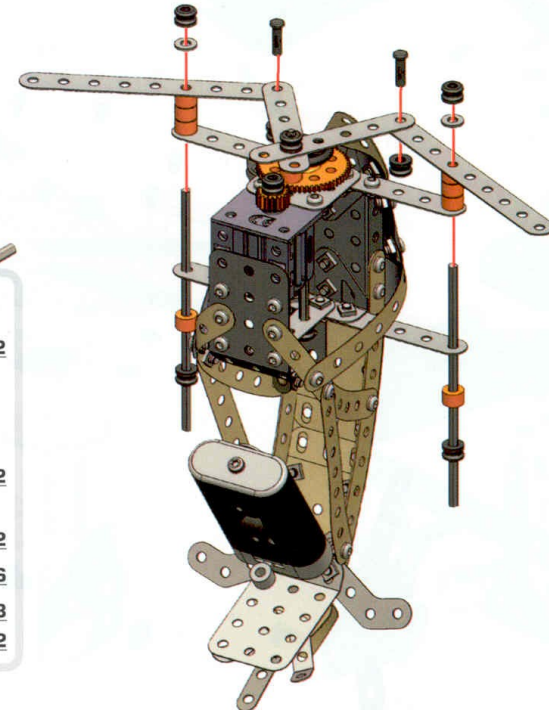

11

10 +

-  x7
-  x7



12

-  x 2
-  x2
-  x2
-  x6
-  x8
-  x2

13

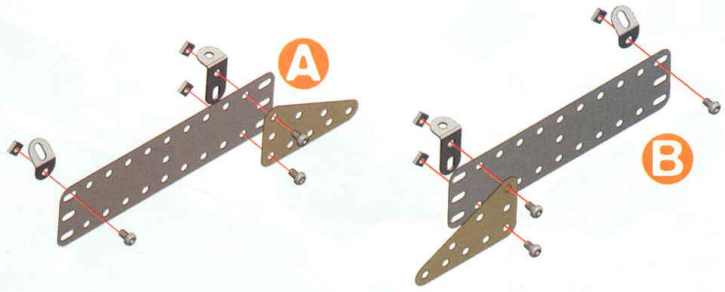
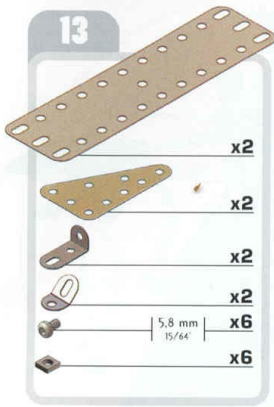

14



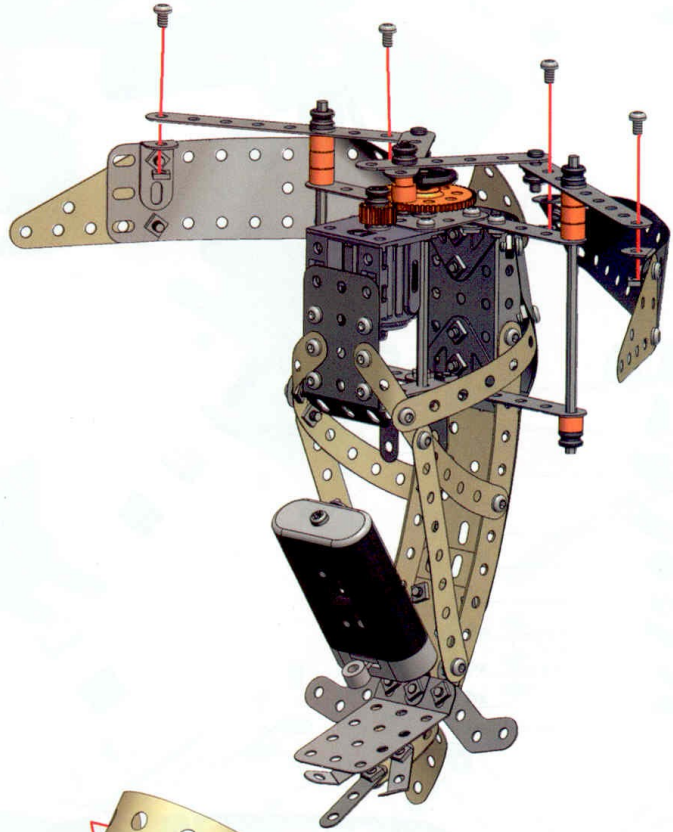
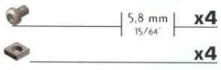

12 + 13 +

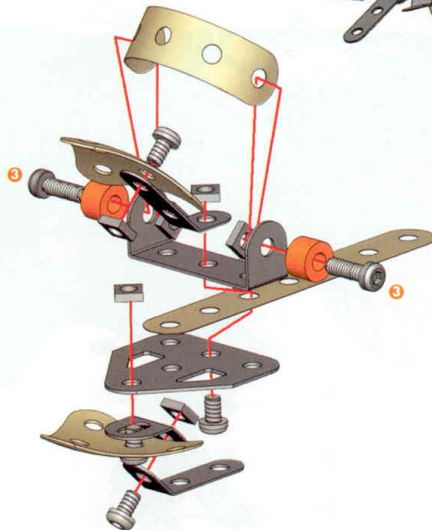
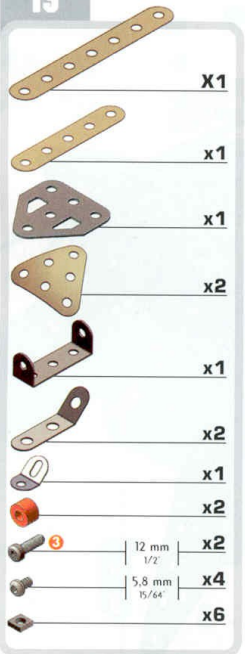

15



# 16



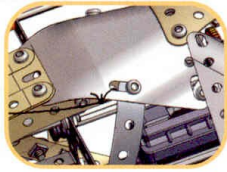
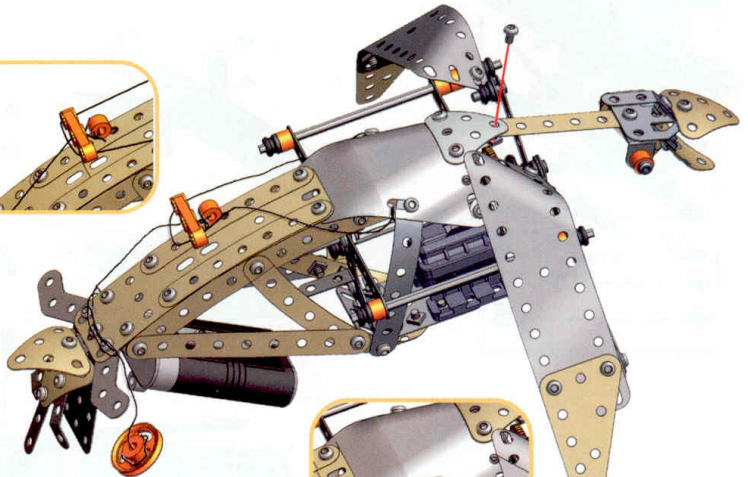
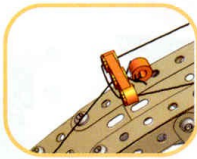



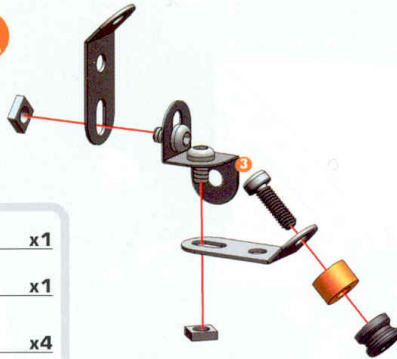

-  x1
-  x1
-  x1
-  x1
-  | 5,8 mm | 15/64 | x1
-  x1



**A**





# 17

-  x1
-  x1
-  x4
-  x2
-  x2
-  | 12 mm | 1/2 | x2
-  | 5,8 mm | 15/64 | x4
-  x4

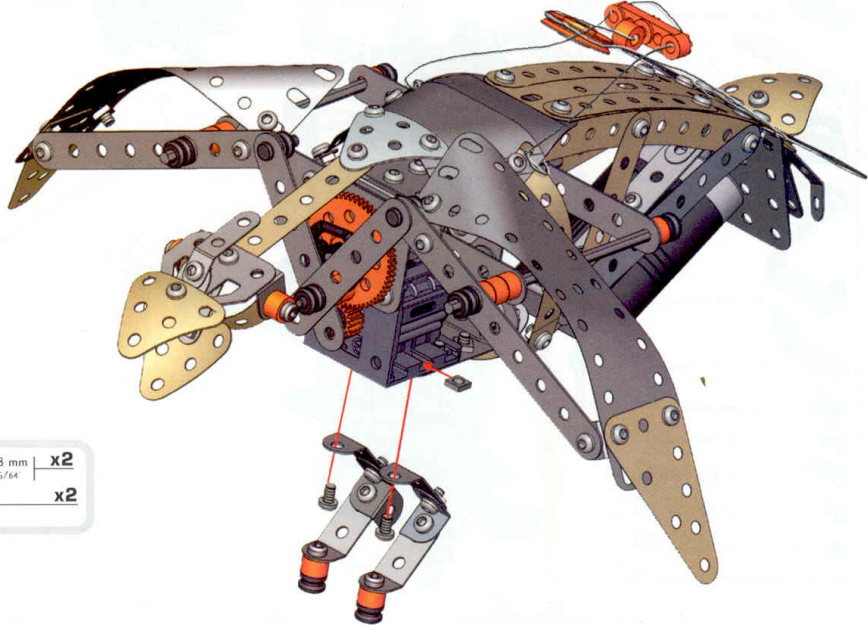
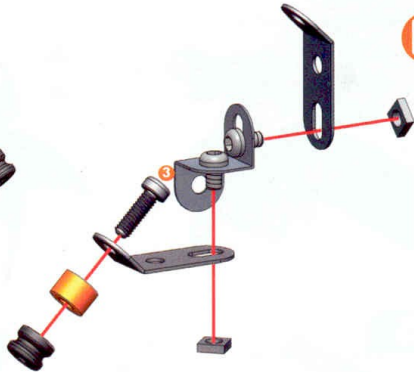
**B**







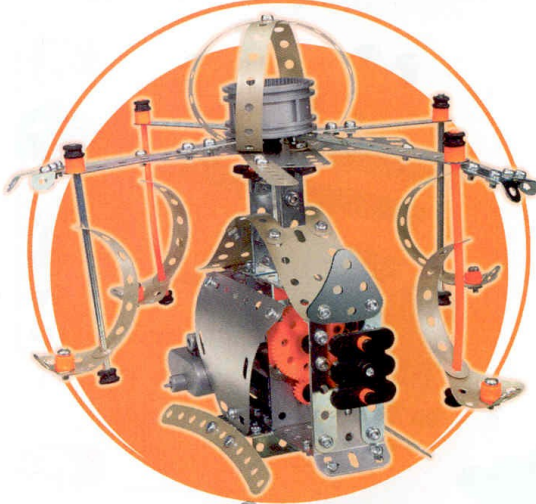

# 18

-  | 5,8 mm | 15/64 | x2
-  x2

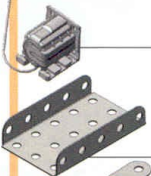





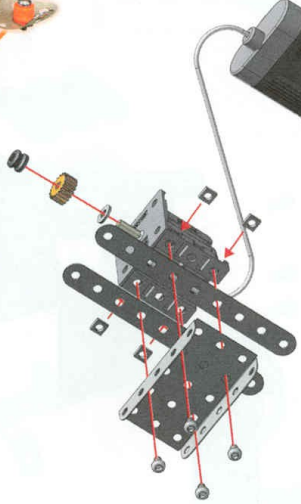
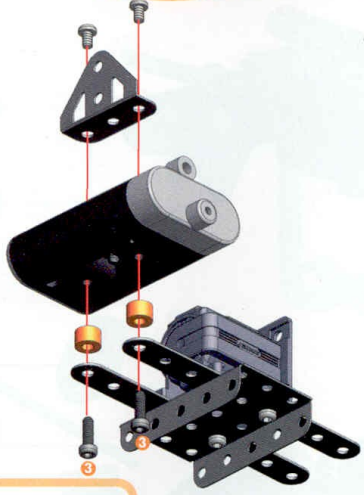

**1**





-  x1
-  x1
-  x2
-  x1
-  x1
-  x1
-  5,8 mm | 15/64" x4
-  x4

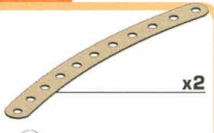

**2**

-  x1
-  x2
-  12 mm | 1/2" x2
-  5,8 mm | 15/64" x2

**3**



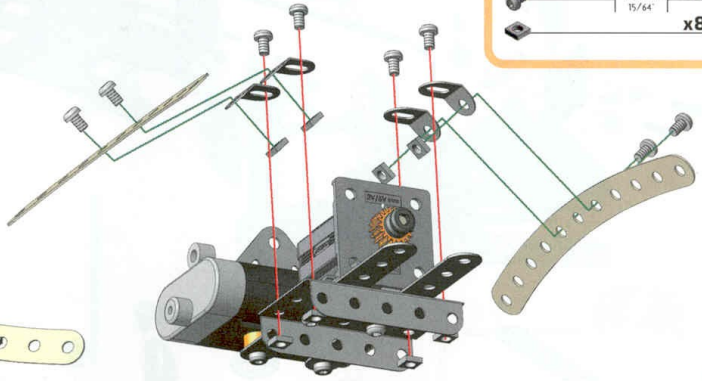
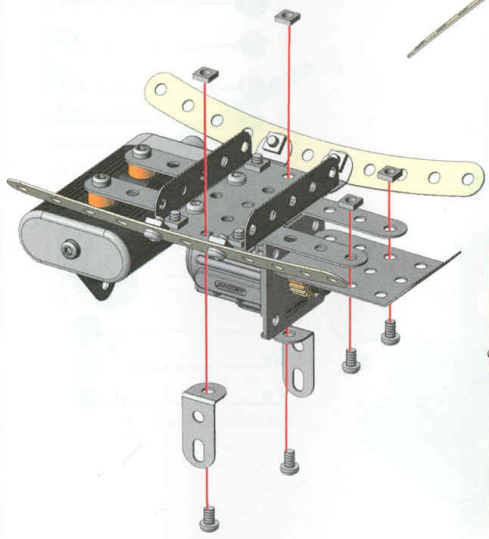

-  x2
-  x4
-  5,8 mm | 15/64" x8
-  x8



**4**

-  x1
-  x2
-  5,8 mm | 15/64" x4
-  x4

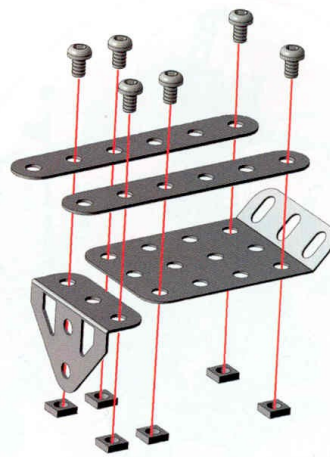

5

-  x1
-  x2
-  x1
-  x6
-  x6





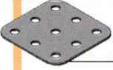



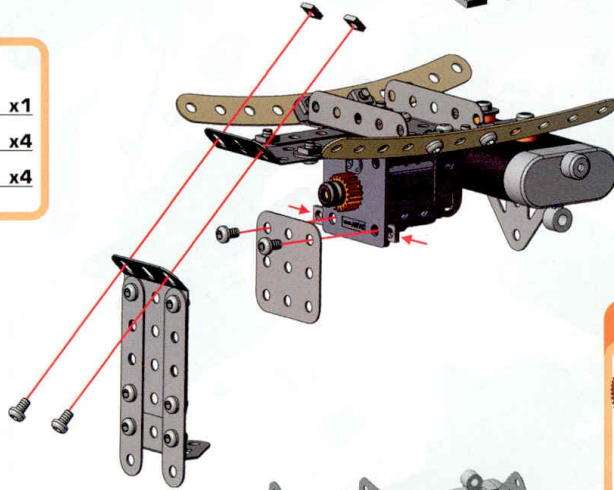



6

④ + ⑤ +

-  x1
-  x4
-  x4







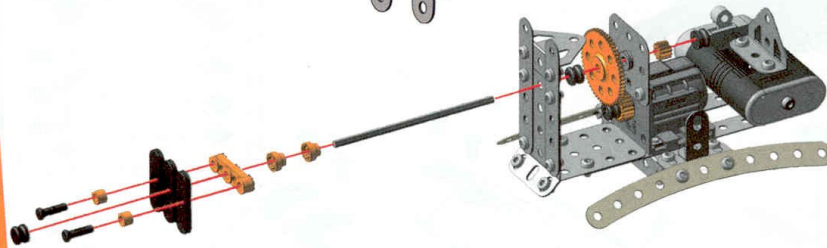

7

-  x1
-  x1
-  x1
-  x1
-  x2
-  x2
-  x1
-  x2
-  x2
-  x2



8

-  x1
-  x1
-  x1
-  x1
-  x3
-  x3

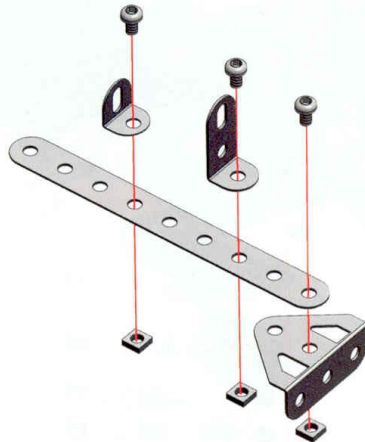

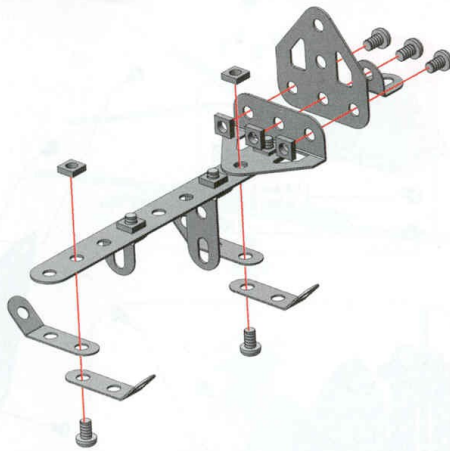
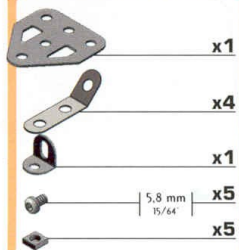
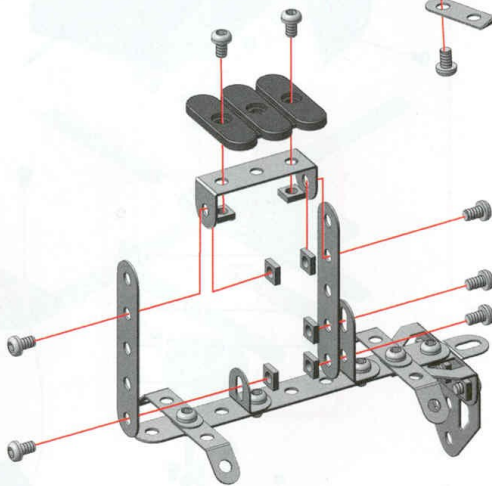
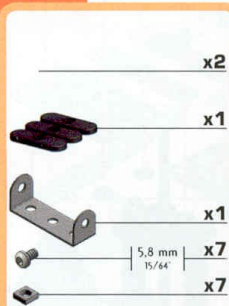
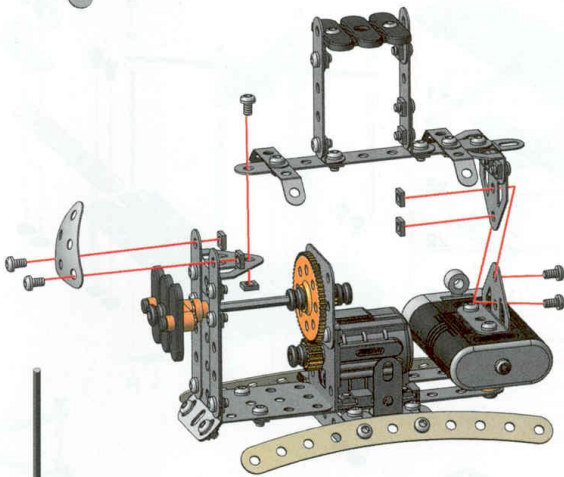
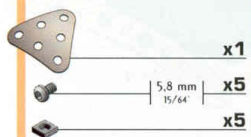
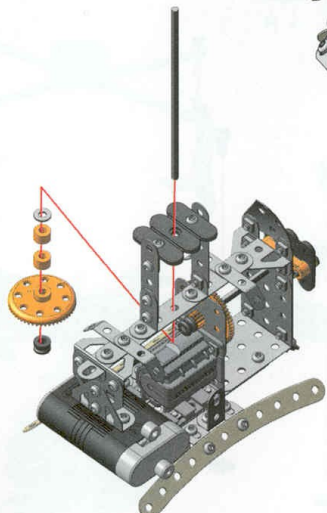
**9****10****11****(7) + (10) +****12**

13

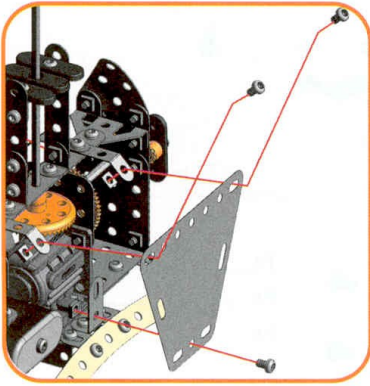
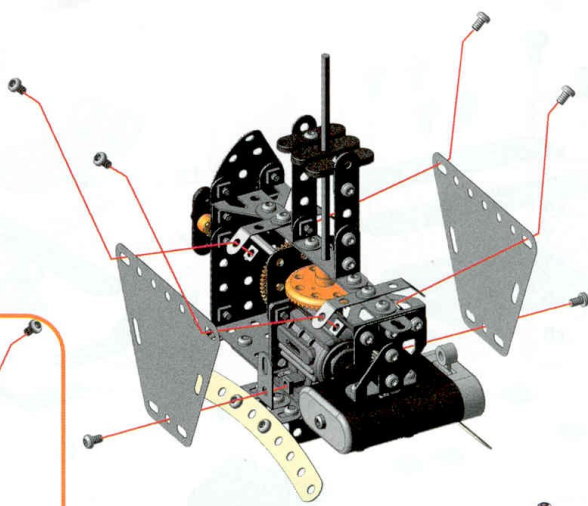
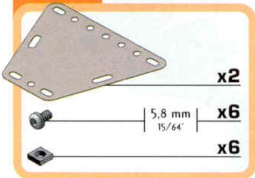

14

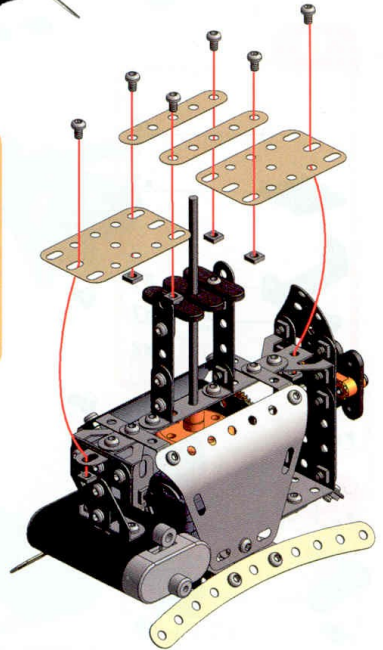
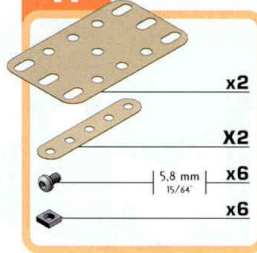



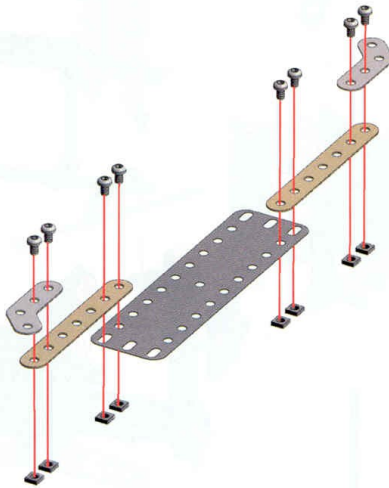
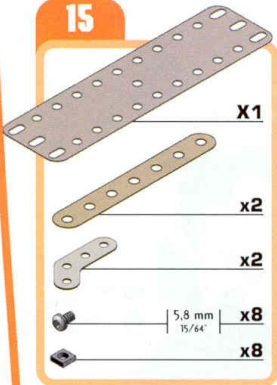

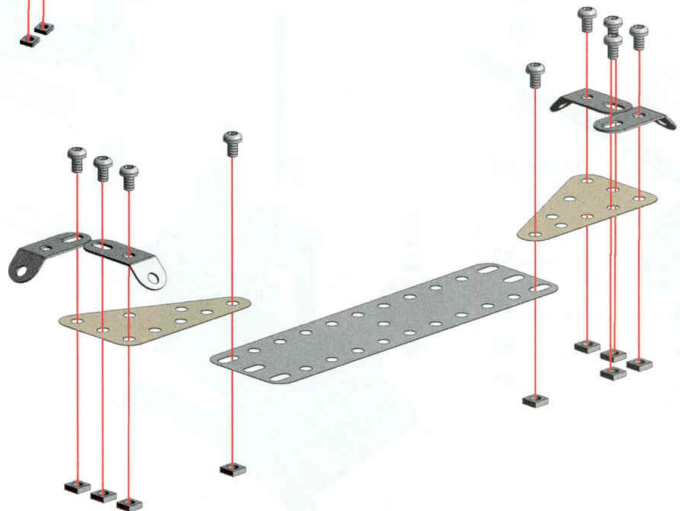

15









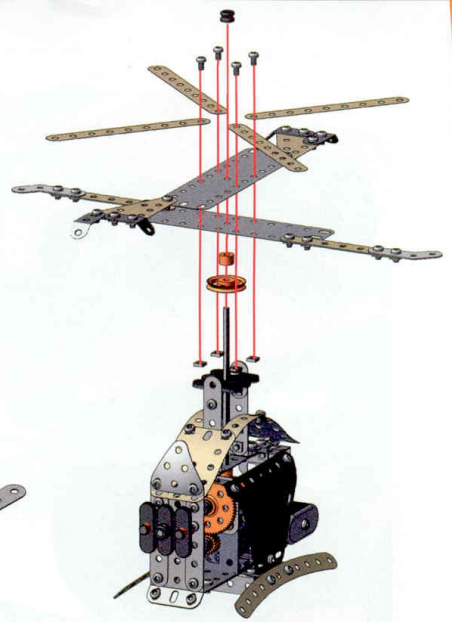

16









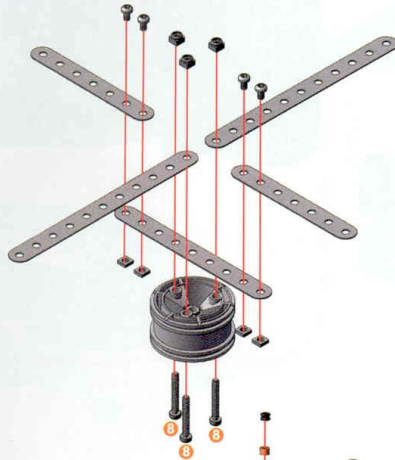

**17****14 + 15 + 16 +**

-  **x4**
-  **x1**
-  **x1**
-  **x1**
-  **x4**
-  **x4**

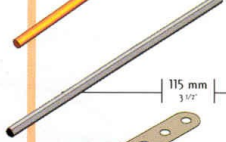
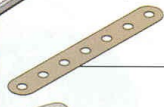

**18**

-  **x2**
-  **x1**
-  **x2**
-  **x1**
-  **x3**
-  **x3**
-  **x4**
-  **x4**

**19****17 + 18 +**

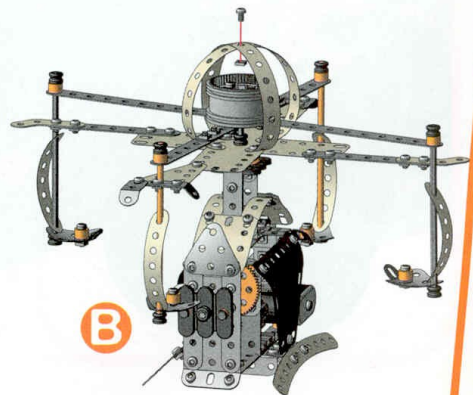
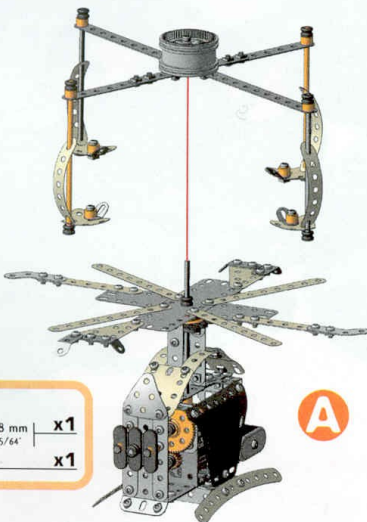
-  **x2**
-  **x2**
-  **x4**
-  **x4**
-  **x4**
-  **x8**
-  **x8**
-  **x4**
-  **x4**

**20**

-  **x1**
-  **x1**

**A****B**

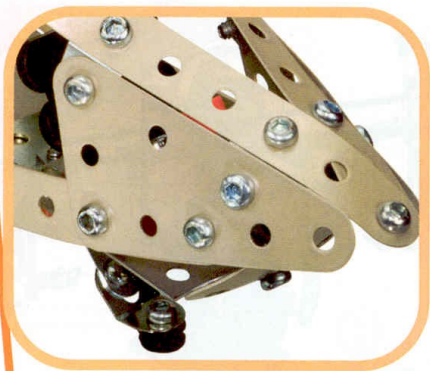
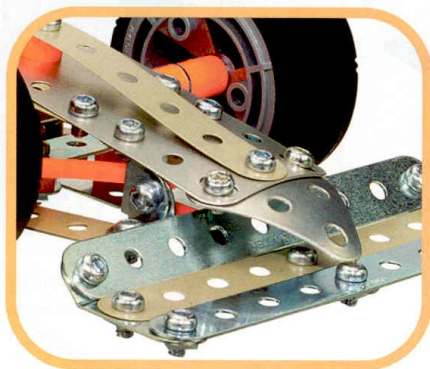
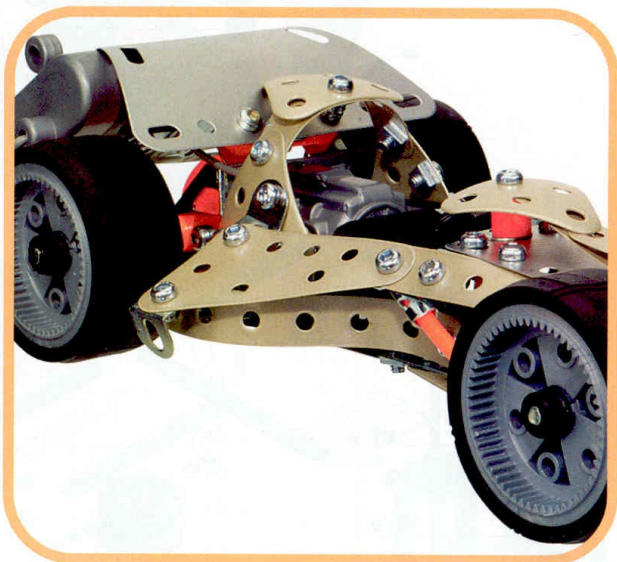
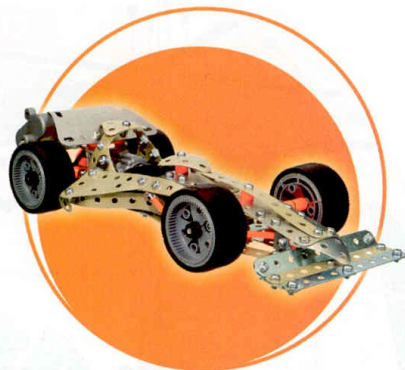

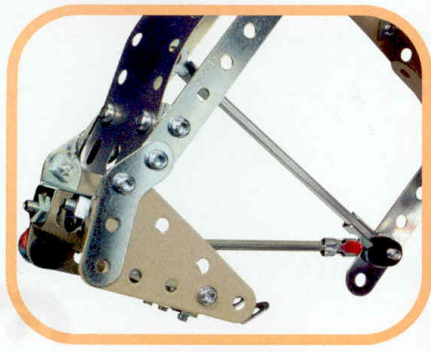
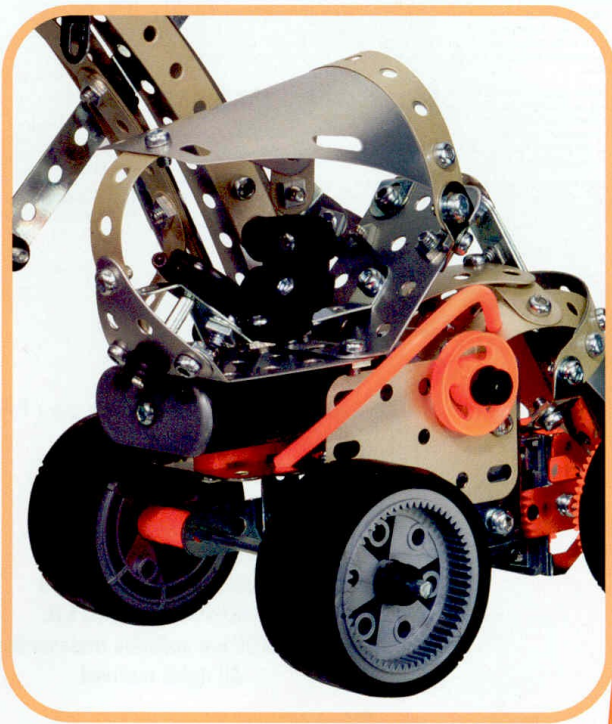
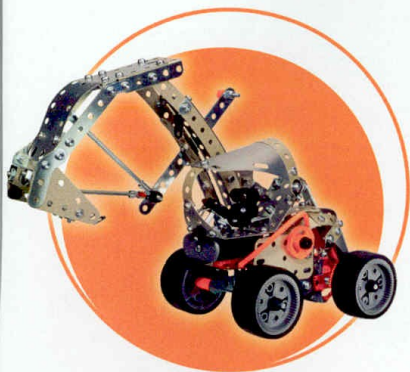
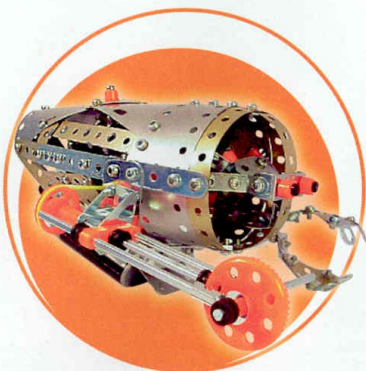
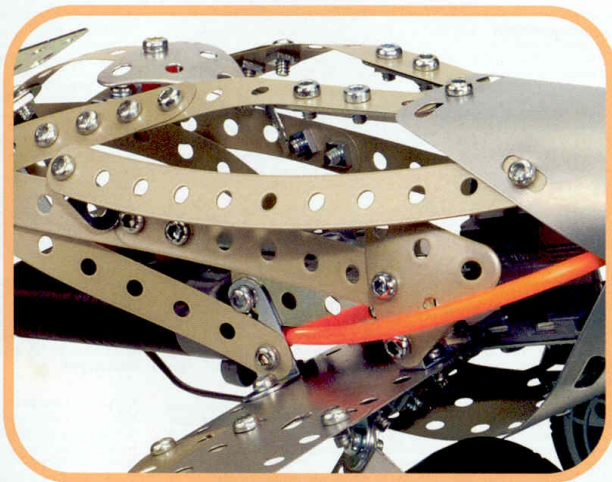
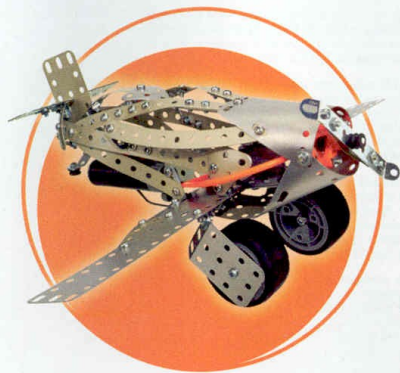

**GB USA** Many of the models and component parts are unique and original designs which are the property of MECCANO S.N. They are protected by national legislation as industrial designs, trademarks and/or copyrights throughout many countries. For detailed information, please contact: MECCANO S.N. Meccano S.N. shall have no responsibility for (I) failure to follow instructions, (II) use of parts for any purpose other than as specified in the instructions (III) any alteration of any parts or components. MECCANO S.N. respects children's safety: all models are tested by children.

**F** De nombreux modèles et pièces sont des créations originales, propriétés de MECCANO S.N. et sont protégés par les législations nationales sur les dessins et modèles, marques et/ou droits d'auteurs. Pour toute information, merci de contacter : MECCANO S.N. La responsabilité de MECCANO S.N. ne saurait être engagée en cas d'accident survenu à la suite (I) du non respect des instructions de montage (II) d'une utilisation des pièces autre que celle proposée dans la notice (III) d'une altération ou de la modification des pièces. La société MECCANO respecte la sécurité des enfants : ses modèles sont testés par des enfants.

**D** Zahlreiche Modelle und Teile sind Erfindungen und Eigentum der Firma MECCANO S.N. Sie sind durch Inland-Gesetze über Zeichnungen und Modelle sowie Warenzeichen und/oder Urheberrechte geschützt. Für zusätzliche Auskünfte wenden Sie sich bitte an: MECCANO S.N. Die Firma MECCANO S.N. haftet nicht für Unfälle, die aus der (I) Nichteinhaltung der Bauanleitung, der (II) Verwendung anderer als in der Bauanleitung angegebenen Teile oder der (III) Änderung oder Modifikation der Teile resultieren. Alle Modelle der Firma Meccano wurden von Kindern getestet und entsprechen den Sicherheitsnormen.

**I** Numerosi modelli e pezzi sono creazioni originali della MECCANO S.N. e sono protetti dalle legislazioni nazionali sui disegni e modelli, marchi e/o diritti d'autore. Per qualsiasi informazione, vogliate prendere contatto con: MECCANO S.N. Meccano S.N. declina ogni responsabilità in caso d'incidenti sopravvenuti in seguito (I) a: non rispetto delle istruzioni di montaggio (II) utilizzo dei pezzi per funzioni diverse da quelle previste nel manuale (III) alterazione e/o modifica dei pezzi. La società MECCANO rispetta la sicurezza dei bambini (I): i suoi modelli vengono testati dai bambini stessi.

**E** Varios modelos e peças são criações originais, propriedades da MECCANO S.N. e están protegidos por las legislaciones nacionales en lo que concierne a los dibujos y modelos, marcas y/o derechos de autor. Para cualquier información, sírvase ponerse en contacto con: MECCANO S.N. MECCANO S.N. carece de responsabilidad en caso de accidente debido a: (I) el incumplimiento de las instrucciones de montaje (II) una utilización de las piezas diferente a la que se indica en las instrucciones (III) una alteración o modificación de las piezas. La sociedad MECCANO respeta la seguridad de los niños: sus modelos están probados por niños.

**P** Vários modelos e peças são criações originais, propriedades da MECCANO S.N. e são protegidos pelas legislações nacionais relativas aos desenhos e modelos, às marcas e/ou aos direitos de autor. Para qualquer informação, é favor contactar: MECCANO S.N. A Sociedade MECCANO S.N. não poderá ser responsabilizada pelos acidentes provocados: (I) pela falta de cumprimento das instruções de montagem (II) pelo uso indevido das peças ou (III) pela modificação ou alteração das peças. A Sociedade MECCANO respeta a segurança das crianças: os seus modelos foram testados por crianças.

**S** Många modeller och delar bildar en unik och original formgivning vilken är MECCANO S.N. egendom. Dessa modeller och delar är skyddade genom lagstiftning såsom industriell formgivning, varumärke och/eller

**GB USA** Standard batteries must not be recharged. Rechargeable batteries must be removed from the toy before being recharged (if it is possible to remove them). Rechargeable batteries must only be recharged under adult supervision (if it is possible to remove them). Do not mix different types of batteries together or new with old rechargeable / non rechargeable batteries. Only batteries of the recommended type or a similar type should be used. Batteries must be fitted in accordance with their instructions. Remove used batteries from the toy. Battery terminals must be short-circuited. Please keep instructions.

**F** Les piles ne doivent pas être rechargées. Les accumulateurs doivent être enlevés du jouet avant d'être rechargés (s'ils peuvent être enlevés). Les accumulateurs ne doivent pas être rechargés sous la surveillance d'un adulte (s'ils peuvent être enlevés). Différents types de piles ou accumulateurs ou des piles ou accumulateurs neufs et usagés ne doivent pas être mélangés. Seuls des piles ou accumulateurs du type recommandé ou d'un type similaire doivent être utilisés. Les piles et accumulateurs doivent être mis en place en respectant la polarité. Les piles et accumulateurs usagés doivent être enlevés du jouet. Les bornes d'une pile ou d'un accumulateur ne doivent pas être mises en court-circuit. Indiqués à conserver.

**D** Die Batterien dürfen nicht wieder aufgeladen werden. Die Akkus müssen vor dem Nachladen aus dem Spielzeug genommen werden (wenn sie ausgebaut werden können). Die Akkus dürfen nur unter Aufsicht eines Erwachsenen nachgeladen werden (wenn sie ausgebaut werden können). Unterschiedliche Arten von Batterien und Akkus oder neue und gebrauchte Batterien bzw. Akkus dürfen nicht zusammen verwendet werden. Es dürfen nur Batterien bzw. Akkus der empfohlenen Art oder einer ähnlichen Art verwendet werden. Beim Einsetzen der Batterien bzw. Akkus auf die richtige Polung achten. Verbrauchte Batterien bzw. Akkus bitte aus dem Spielzeug entfernen. Die Klammern der Batterien bzw. Akkus dürfen nicht kurzgeschlossen werden. Diese Anweisungen bitte aufbewahren.

**I** Le pile non devono essere ricaricate. Gli accumulatori devono essere tolti dal giocattolo prima di essere ricaricati (se è possibile toglierli). Gli accumulatori devono essere ricaricati solo sotto la sorveglianza di un adulto (se è possibile toglierli). Non possono essere mescolati tipi diversi di pile o di accumulatori oppure pile o accumulatori nuovi e usati. Si devono usare solo pile o accumulatori del tipo raccomandato o di un tipo simile. Le pile e gli accumulatori devono venire sistemati rispettando la polarità. Le pile e gli accumulatori usati devono essere tolti dal giocattolo. I morsetti di una pile o di un accumulatore non devono essere messi in cortocircuito. Conservare queste istruzioni.

**E** Las pilas no deberán recargarse. Habrá que retirar los acumuladores del juguete antes de proceder a recargarlos (si es que pueden retirarse). Los acumuladores sólo se recargarán bajo la vigilancia de una persona adulta (si es que pueden retirarse). No deberán mezclarse diferentes tipos de pilas o acumuladores o pilas o acumuladores nuevos y usados. Sólo se utilizarán pilas o acumuladores del tipo recomendado o de un tipo similar. Las pilas y acumuladores deberán colocarse respetando la polaridad. Deberán retirarse del juguete las pilas y acumuladores usados. Lors bornes de una pile o de un acumulador no deberán disponerse nunca en posición de cortocircuito. Conserve estas indicaciones.

**P** As pilhas não devem ser novamente carregadas. Os acumuladores devem ser removidos do brinquedo antes de serem carregados (caso possam ser removidos). Os acumuladores devem ser carregados apenas sob cuidados de um adulto (caso possam ser removidos). Diferentes tipos de pilhas ou acumuladores ou pilhas ou acumuladores novos já utilizados não devem ser misturados. Pilhas ou acumuladores do tipo recomendado ou de um tipo similar poderão ser utilizados. As pilhas e acumuladores devem ser inseridos, respeitando a polaridade. Devem ser removidos do brinquedo as pilhas e acumuladores já utilizados. Os polos de uma pilha ou de um acumulador não devem ser curto-circuitados. Indiquês a conservar.

**S** Batterierna skall inte laddas om. Akkumulatort batterierna skall tas av från lekstoken innan de laddas (om de kan tas av). Akkumulatort batterierna skall endast laddas under uppsikt av en vuxen (om de kan tas av). Olika typer av batterier eller akkumulatort batterier skall inte blandas. Nya och använda batterier eller akkumulatort batterier skall inte blandas. Använd endast rekommenderade typer eller likartade typer av batterier eller akkumulatort batterier. Batterierna och akkumulatort batterierna skall sättas i med hänsyn till polerna. Använda batterier och akkumulatort batterier skall tas av från lekstoken. Kontaktsterna på ett batteri eller ett

upphovsmannorätt i ett flertal länder. För mer detaljerad information, var vänlig och kontakta MECCANO S.N. MECCANO S.N. frångår sig allt ansvar i händelse av olycka till följd av (I) att monteringsinstruktionerna inte har respekterats (II) en annan användning av delarna än den som står i anvisningen (III) en förändring eller förändring av delarna. Företaget MECCANO respekterar barns säkerhet: modellerna har testats av barn.

**FIN** Usat mallit ja osat ovat MECCANO S.N.:n omaisuutta elävien alkuperäisistä suunnitelmista. Ne ovat kansallisia lailla suojattua teollista tuotantoa, tavaramerkkejä ja/tai kopiointioikeuksia. Pyydämme ottamaan yhteyden MECCANO S.N.:han kaikissa asioissa liittyvissä kysymyksissä. MECCANO S.N. ei vastaa eikä kata seuraavista syistä sattuneita onnettomuuksia: (I) ohjeiden vastainen kokoonpano, (II) muiden kuin ohjeissa ehdotettujen osien käyttö, (III) osien muuttelu tai eri tarkoituksien käyttö. MECCANO-yhtiö huolehtii lasten turvallisuudesta: lapset ovat testanneet mallimme.

**DK** Vore mange modeller og dele er originale fremstillinger og ejes af MECCANO S.N. Tegninger, modeller, fabrikationsmærker og ophavsret er lovbeskyttet i hvert land. Yderligere oplysninger kan fås hos MECCANO S.N. MECCANO S.N. fraviger sig ethvert ansvar, såfremt der er sket uheld forårsaget af (I) at monteringsinstruktionerne ikke er blevet overholdt, (II) at delene er blevet brugt til andre formål, end dem der er beskrevet i betjeningsvejledningen, (III) eller at delene er blevet beskadiget eller ændret. MECCANO overholder sikkerhedsreglerne for børn: Alle modeller testes af børn.

**NL** Veel modellen en onderdelen zijn originele ontwerpen en eigendom van MECCANO S.N. en worden beschermd door de nationale wetgeving op tekeningen en modellen, merken en/of auteursrechten. Voor informatie gelieve contact op te nemen met MECCANO S.N. De verantwoordelijkheid van MECCANO S.N. is uitgesloten in geval van ongevallen voortvloeiend uit het niet naleven van de montage-instructies (I), uit het gebruik van andere onderdelen dan de zoals vermeld in de handleiding (II) of uit het veranderen of modificeren van de onderdelen (III). De firma MECCANO neemt de veiligheid van de kinderen in acht: de modellen zijn door kinderen getest.

**GR** Πολλά μοντέλα και ανταλλακτικά είναι αυθεντικά, ιδιοκτησία της MECCANO S.N. και προστατεύονται από τις εθνικές νομοθεσίες για τα μοντέλα της μαρκας ή τα διπλώματα ευρεσιτεχνίας. Για κάθε πληροφορία παρακαλώ απευθύνεστε στη MECCANO S.N. Η ευθύνη της MECCANO S.N. δεν δεσμεύεται σε περίπτωση ατυχημάτων που είναι συνέπεια (I) μη σεασημού των οδηγίων αναμολόγησής (II) χρήσης των τεμαχίων διαφορετικά από αυτήν που προτείνεται στα οδηγίες (III) καταστροφής ή αλλαγών των τεμαχίων. Η εταιρεία MECCANO ερεθεί την ασφαλεία των παιδιών: τα μοντέλα της δοκιμάζονται από παιδιά.

**JPN** モデルならびに部品は、その多くがMECCANO社所有のオリジナル・デザインにて、意匠・商標および/または著作権に関する国内法によって保護されています。詳細については、当社 (MECCANO S.N.) メカノ社は、何れも注意事項を伴わなかった場合、(II) 使用説明書に記載されたもの以外の部品を使用した場合、(III) 部品を改造・改造した場など起きた事故については責任を負うことはできません。メカノ社の全モデルは事前に子供たちによりテストを行い、その安全性を確認されています。

akkumulatort batteri skall inte kortslutas. Bevaka anvisningarna.

**FIN** Paristoa ei saa ladata uudelleen. Akut on otettava ulos leikkikalusta ennen lataamista (jos se on mahdollista). Akut saa ladata vain aikuisen valvonnassa (jos ne voidaan ottaa ulos). Erityysoja paristoja tai akkuja ei saa käyttää yhdessä, samoin ei saa sekoittaa akkuja ja uusia ja vanhoja paristoja. Niin suositellaan, että kaikki paristotyyppit ja käyttöä tai tyyppeä, jollain on samat ominaisuudet. Paristo ja akut on asetettava polkuihden niin, että napaat tulevat oikeisiin suuntiin. Lopputuotteen paristot tai akut on otettava leikkikalusta ulos. Akut tai pariston napaaja ei saa oikaistua. Ohjeet on pidettävä tallella.

**DK** Batterierne må ikke oplades. Akkumulatort batterier skal tages ud af legetøjet, inden de lades op (hvis de kan tages ud). Akkumulatort batterierne må kun lades op under opsyn af voksne (hvis de kan tages ud). Forskellige typer batterier og akkumulatort batterier, eller nye og brugte batterier, må ikke blandes sammen. Der må kun anvendes batterier eller akkumulatort batterier af den type der er anbefalet eller tilsvarende modeller. Batterier og akkumulatort batterier skal vendes rigtigt (+/- poler). Brugte batterier og akkumulatort batterier skal tages ud af legetøjet. Klammere på et batteri eller et akkumulatort batteri må ikke kortsluttes. Disse instruktioner bør opbevares.

**NL** De batterijen mogen niet weer opgeladen worden. De accu's moeten voor het laden uit het speelgoed verwijderd worden (indien ze verwijderd kunnen worden). Gebruik geen verschillende typen batterijen of accu's of gebruikte en nieuwe batterijen of accu's door elkaar. Gebruik alleen batterijen of accu's van het aanbevolen type of van een gelijkwaardig type. Let bij het plaatsen van de batterijen en accu's goed op de juiste polariteit. De verbruikte batterijen en accu's dienen uit het speelgoed verwijderd te worden. De aansluitingen van een batterij of van een accu mogen niet kortgesloten worden. Aanwijzingen om te bewaren.

**GR** Βαταρία είναι φορτιστεί. Ακκουλτορ μπαταρίες πρέπει να αφαιρεθούν από το παιχνίδι πριν από την επαναφόρτιση (εάν είναι δυνατόν). Οι μπαταρίες πρέπει να φορτιστούν μόνο υπό την επίβλεψη ενός ενήλικα (εάν είναι δυνατόν να αφαιρεθούν). Μην αναμιγνύετε διαφορετικούς τύπους μπαταριών ή φορτιστών ή νέων και παλιών φορτιστών/μη φορτιστών μπαταριών. Μόνο μπαταρίες ή φορτιστές του τύπου που συστήνεται ή παρόμοιο τύπου πρέπει να χρησιμοποιούνται. Οι μπαταρίες και φορτιστές πρέπει να τοποθετούνται σύμφωνα με την πολικότητα. Οι μπαταρίες και φορτιστές που έχουν χρησιμοποιηθεί πρέπει να αφαιρεθούν από το παιχνίδι. Τα ακροαγωγία των μπαταριών ή φορτιστών δεν πρέπει να βραχυκυκλωθούν. Διατηρήστε αυτές τις οδηγίες.

**JPN** 電池は充電しないで下さい。蓄電池は充電する前に玩具から取り外して下さい (玩具から取り外せるようになっている場合)。蓄電池の充電は必ず大人のいるところで行って下さい (玩具から取り外せるようになっている場合)。電池や蓄電池は、使用前、使用済、あるいは異なる種類のものなどを混ぜ合わせておかないで下さい。電池や蓄電池は、指定の種類、またはそれに類似したもの以外は使わないで下さい。電池や蓄電池をセットする時には、極性と種類の向きをよく確認して下さい。使用済の電池や蓄電池は玩具から取り外して下さい。電池や蓄電池の極はショートしないよう取り扱いに注意して下さい。この説明書は保存しておいて下さい。

**USA** Do not mix old and new batteries. Do not mix alkaline, standard (carbon-zinc), or rechargeable (nickel-cadmium) batteries.

Made in France by / Fabriqué en France par / Fabricado en Francia por :



363, avenue de Saint Exupéry  
62100 Calais - France  
<http://www.meccano.com>

© 08/2003 MECCANO S.N.

® MECCANO and ERECTOR are exclusive trademarks of MECCANO S.N.

All rights reserved