

Instructions
Notice de montage
Bauanleitung
Istruzioni di montaggio
Instrucciones de montaje
Instruções de montagem
Monteringsanvisning
Kokoamisohje
Monterings instruktioner
Montagehandleiding

Οδηγίες συναρμολόγησης.
組立説明書

DESIGN 3

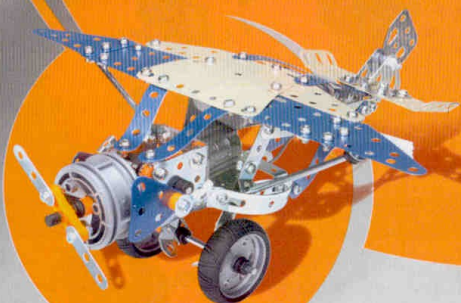
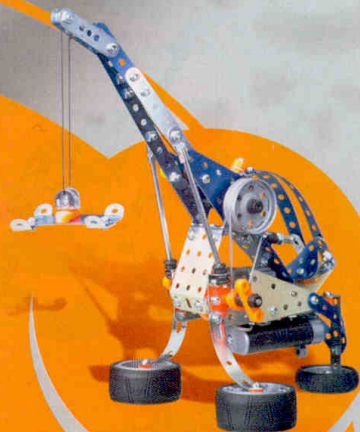

8-15



#6700

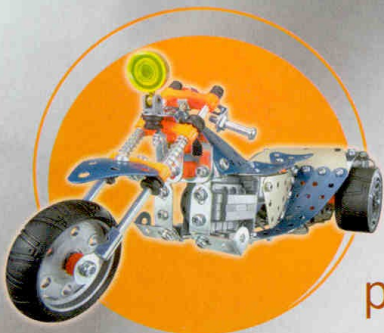

p.6

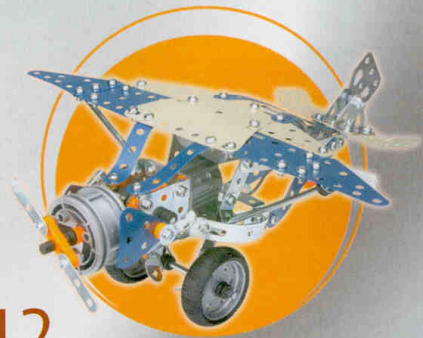

p.12



p.18

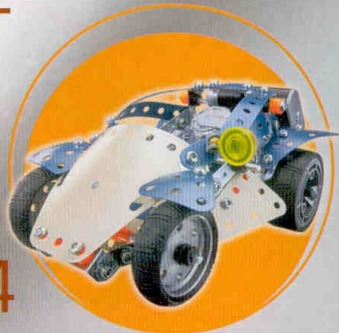

p.24



p.29



p.32

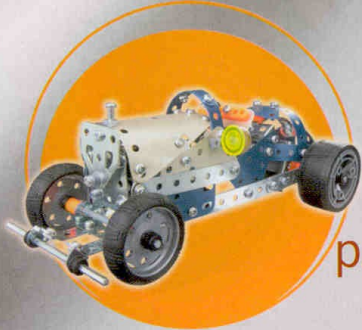

p.35



p.38



p.39

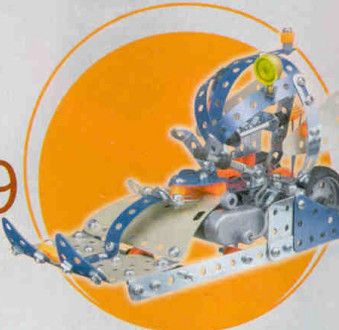

p.39



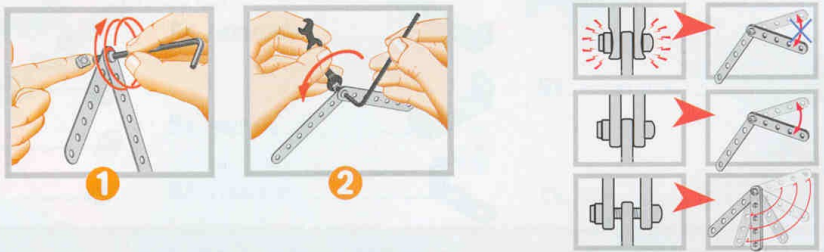
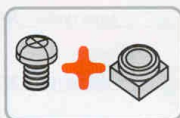
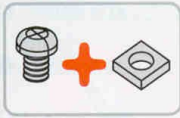
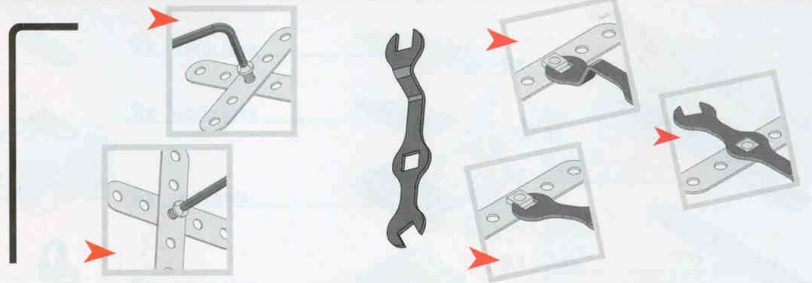
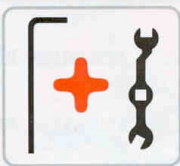

28 mm 1 1/8"		1
25,4 mm 1"		8
23 mm 29/32"		5
19,2 mm 3/4"		6
14,7 mm 9/16"		7
12 mm 1/2"		3
9,5 mm 3/8"		4
5,8 mm 15/64"		

Scale
Échelle
Maßstab
Scala

Escala
Schaal
Escala
Skala

Mittakaava
Målestok
Κλίμακα
スケール

1:1



50 mm 2"	
60 mm 2 3/8"	
100 mm 3 1/2"	
130 mm 3 1/2"	

1

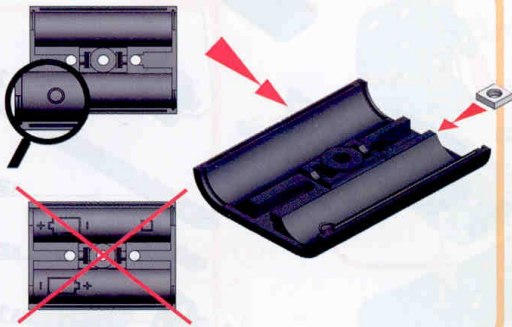

2

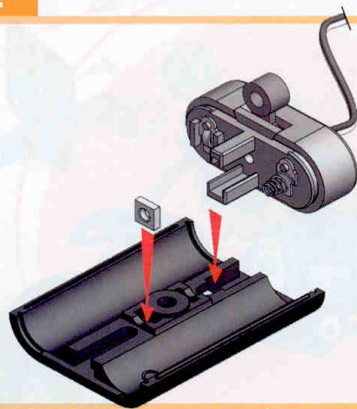

3



4



5

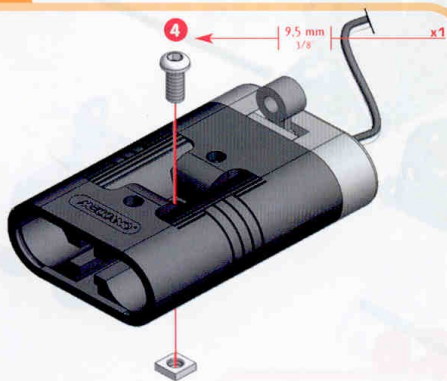

6

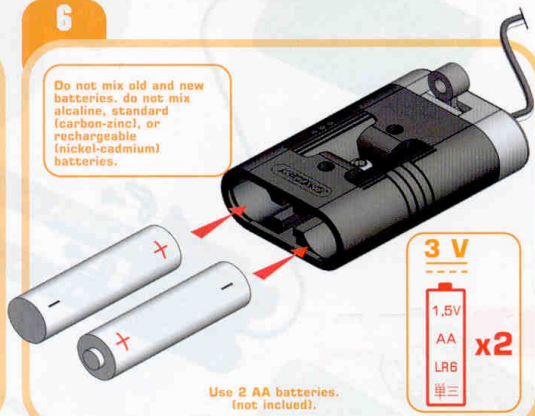

7



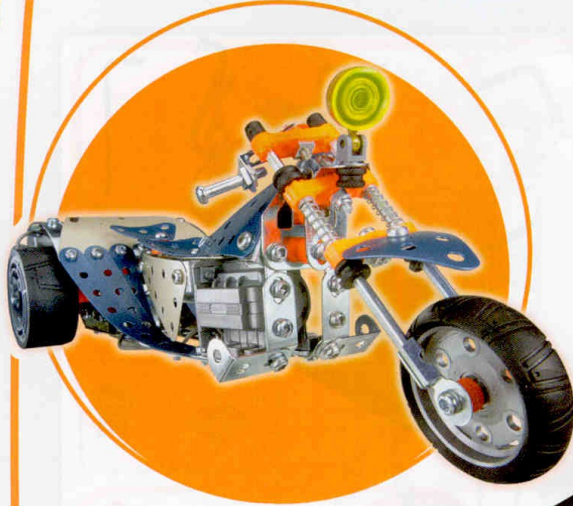

1

- x1
- x2
- x2
- x1
- x2
- 5,8 mm 15/64 x4
- x4

5

- x1
- x1

2

- 100 mm 3 1/2" x1
- x1
- x2
- x1
- x2
- 5,8 mm 15/64 x2
- x2

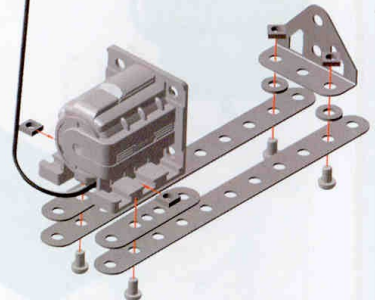

3

- x2
- x2
- 5,8 mm 15/64 x6
- x6

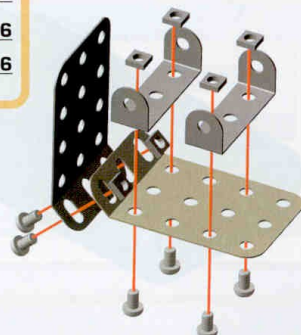

4

- x1
- x1
- x1
- x2
- x2
- 5,8 mm 15/64 x6
- x6

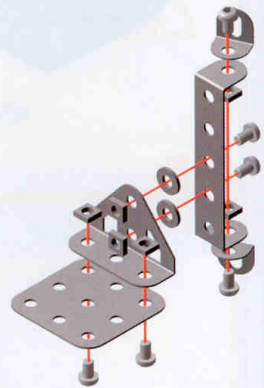

5 ② + ③ + ④ +

	x1
	x2
	x2
	x4
	x4

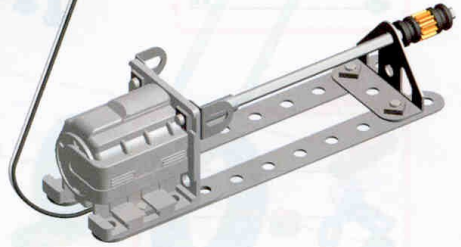
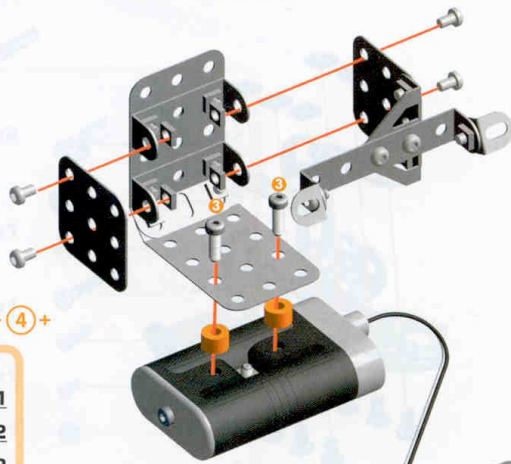

6 ⑤ +

	x2
	x2

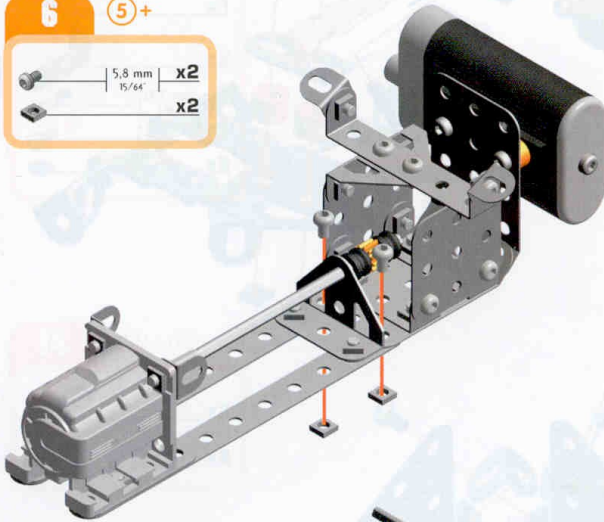

7

	130 mm 5/16	x1
	x1	
	x2	
	x1	

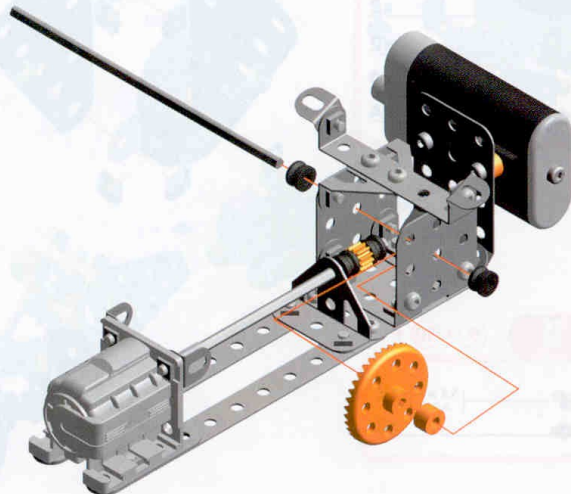

8

	x1
	x2
	x2
	x2
	x2
	x2
	x8
	x8

**9**

	x1
	x1
	x1
	x1
	x1
	x1
	x2
	x1
	x1
	x2
	x1
	x2

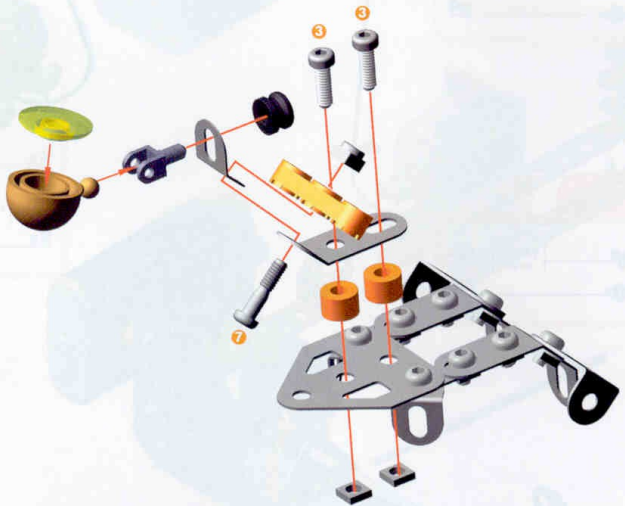
**10**

	x2
	x2
	x4
	x4

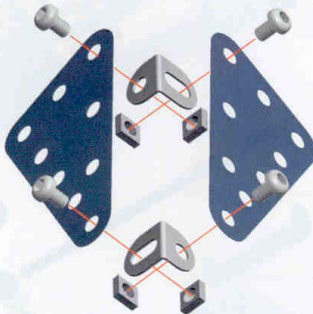
**11****9** + **10** +

	x2
	x2

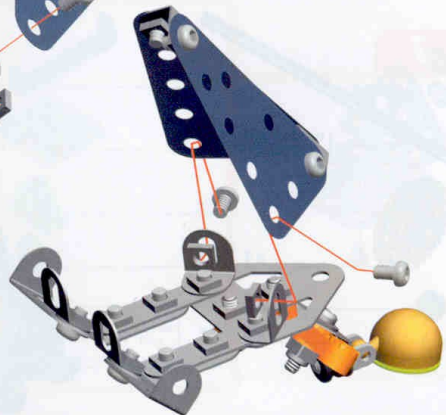

12



13

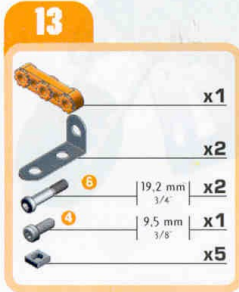

14

(12) + (13) +



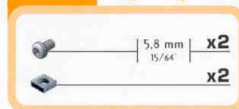

15

(7) + (14) +



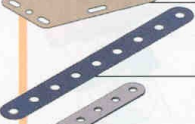

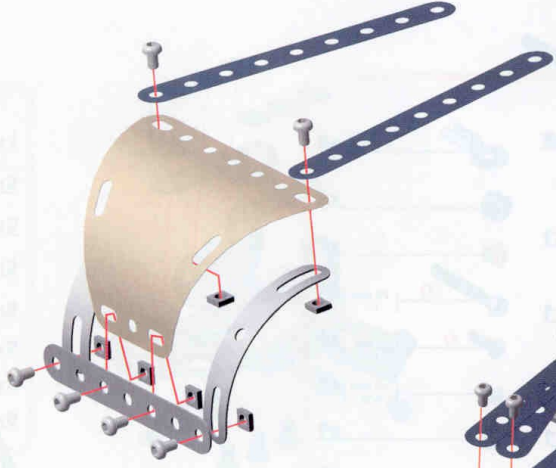

16

-  x1
-  x2
-  x1
-  x2
-  x6
-  x6







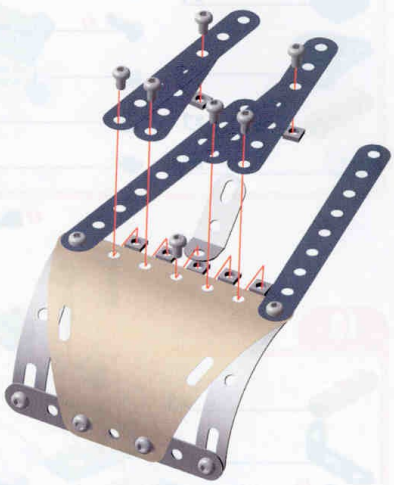

17

-  x2
-  x2
-  x1
-  x7
-  x7





18

-  x1
-  x2
-  x2
-  x1
-  x1
-  x2
-  x3



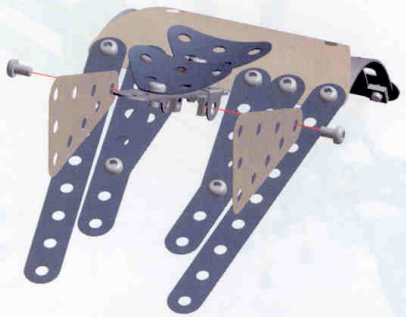

19

-  x2
-  x2
-  x2



20

15 + 19 +

	5,8 mm	x8
	15/64"	x8

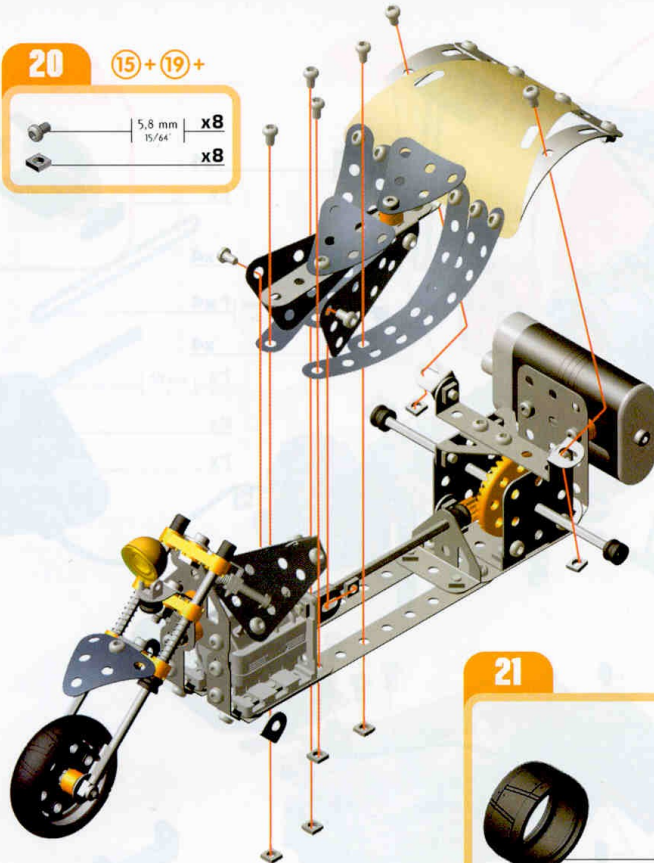

21

		x2
		x2
		x4
		x2

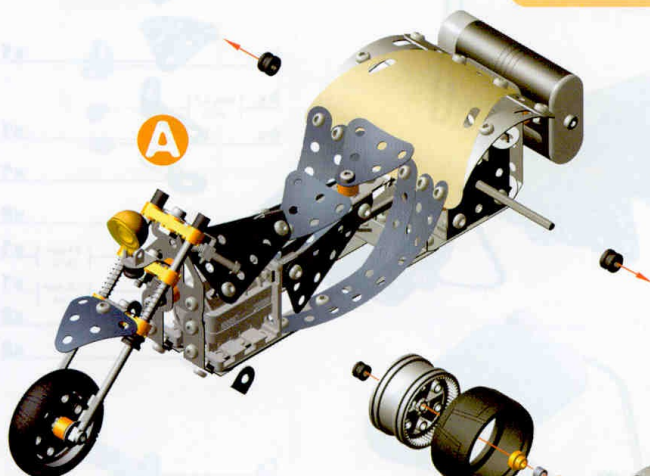



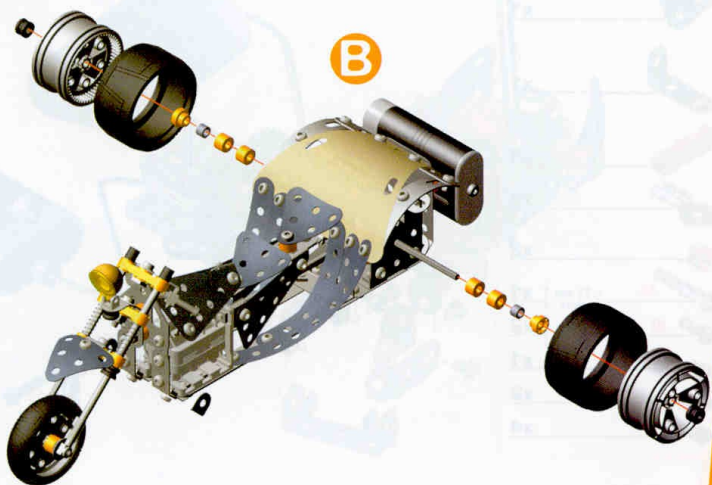

A

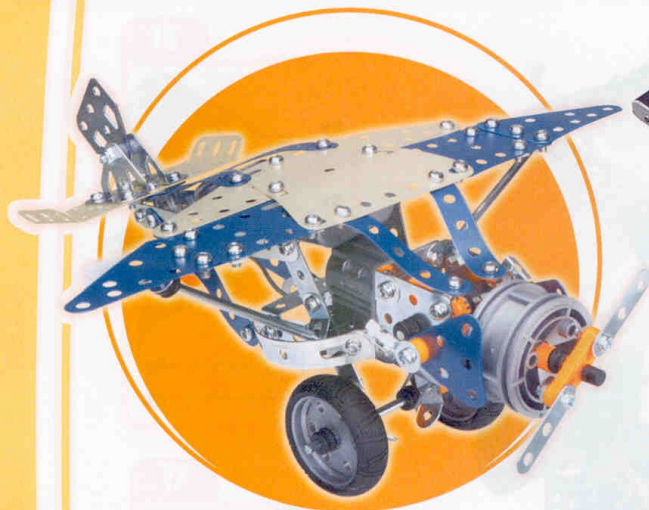







B



- 1**
-  x1
 -  x4
 -  x4
 -  x4



- 2**
-  x2
 -  x2
 -  x1
 -  x1
 -  x4
 -  x4

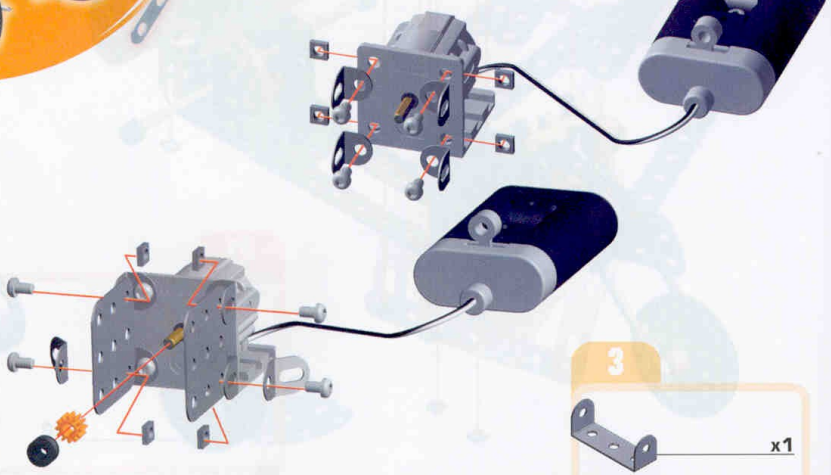

- 3**
-  x1
 -  x1
 -  x1
 -  x1
 -  x2
 -  x1
 -  x1
 -  x2
 -  x2

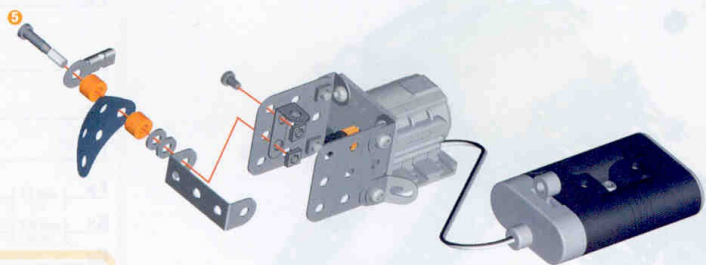

- 4**
-  x1
 -  x1
 -  x1
 -  x1
 -  x2
 -  x1
 -  x2
 -  x1
 -  x2
 -  x4

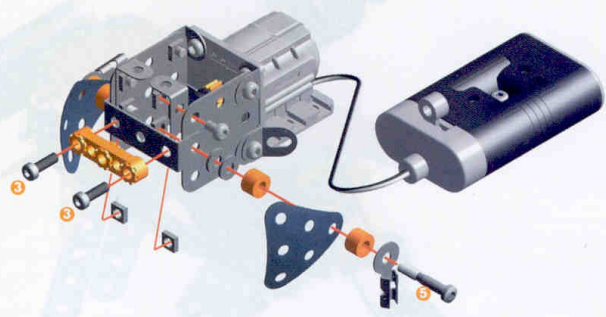

5



x1



x1



x1

50 mm

2



x3



x1

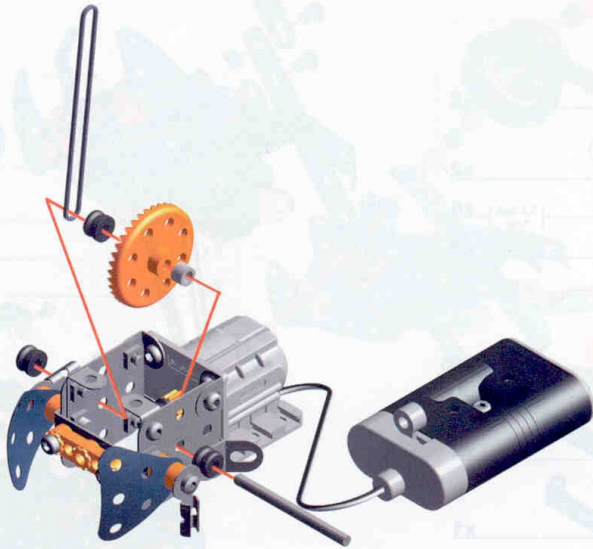

6



x4



5,8 mm

15/64"

x4



x4

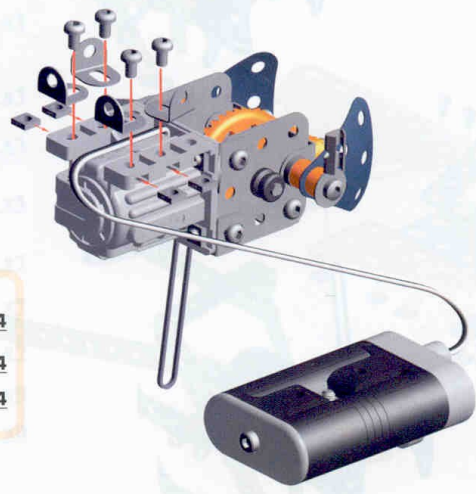

7



x1



x2



x2



5,8 mm

15/64"





x4



x4





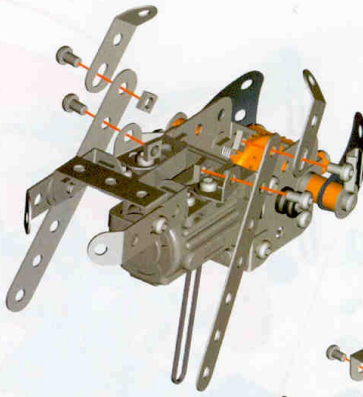

8

-  x2
-  x2
-  | 5,8 mm | 15/64" x4
-  x4





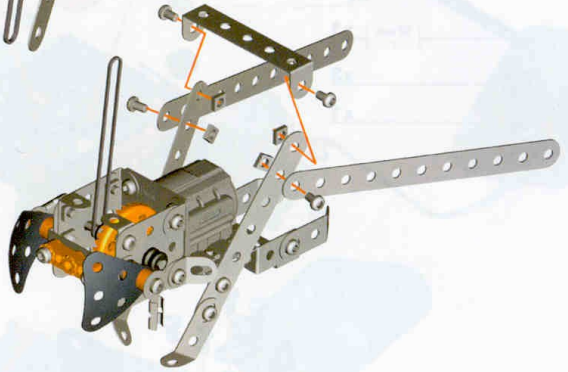

9

-  x2
-  x1
-  | 5,8 mm | 15/64" x4
-  x4



10

-  x2
-  x2
-  | 5,8 mm | 15/64" x4
-  x4

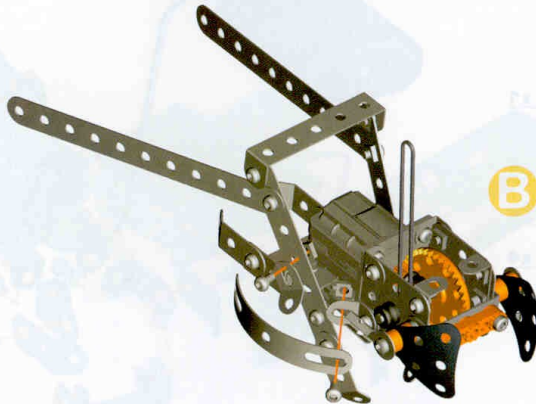
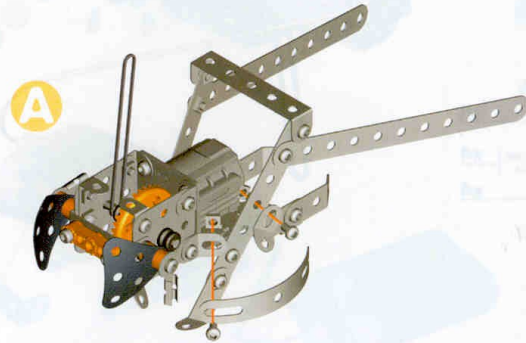

11

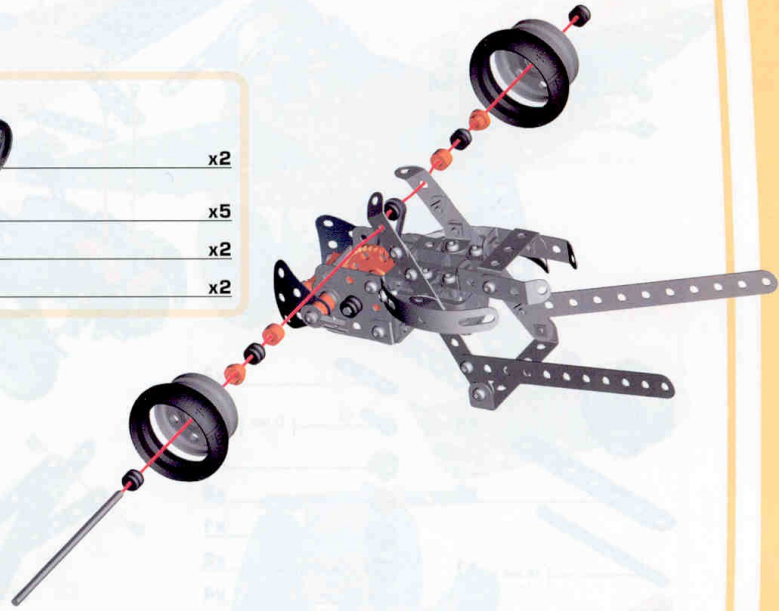
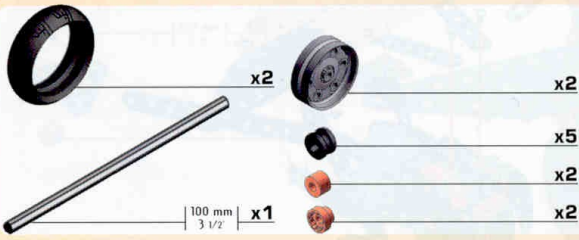

12

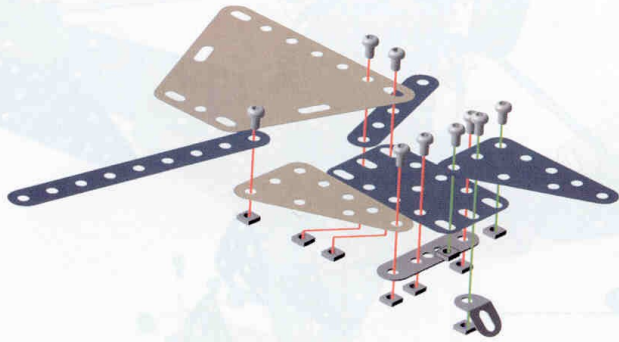
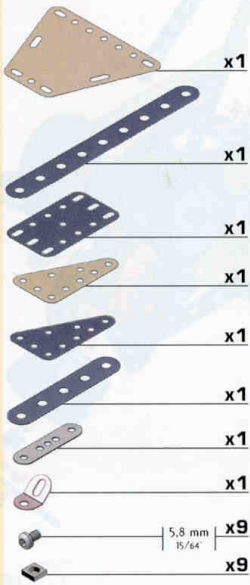

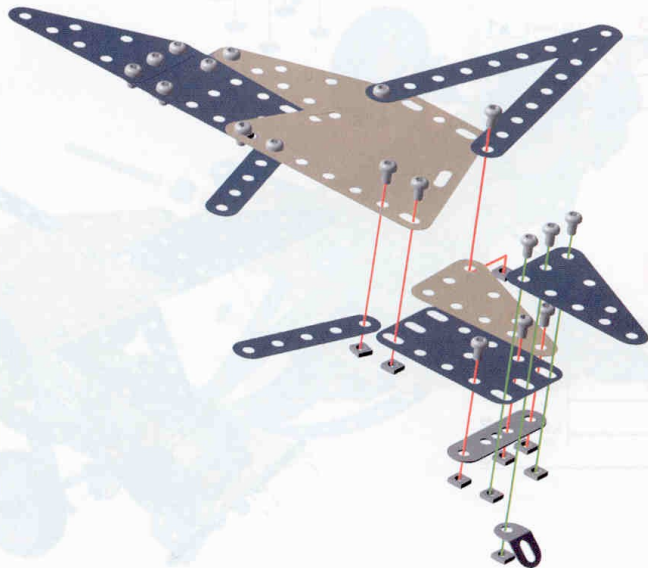
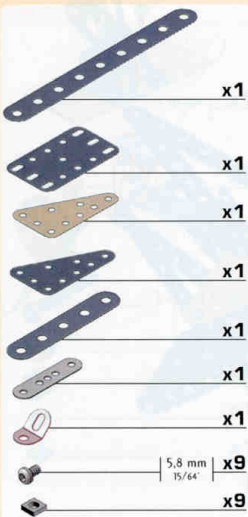

13



14

(11) + (14) +

	5,8 mm 15/64	x4
		x4

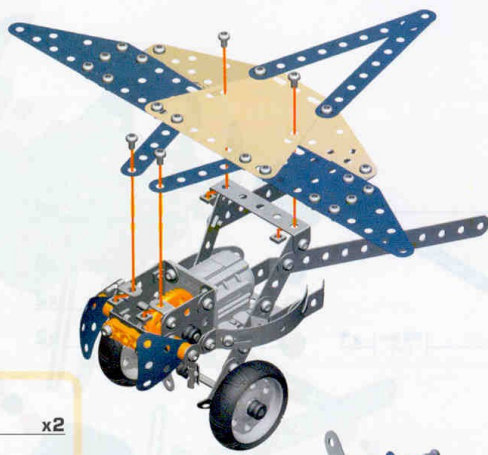

15



x1



x2



x1



x1



x2



x2



x1



x2



x2



x4



x6

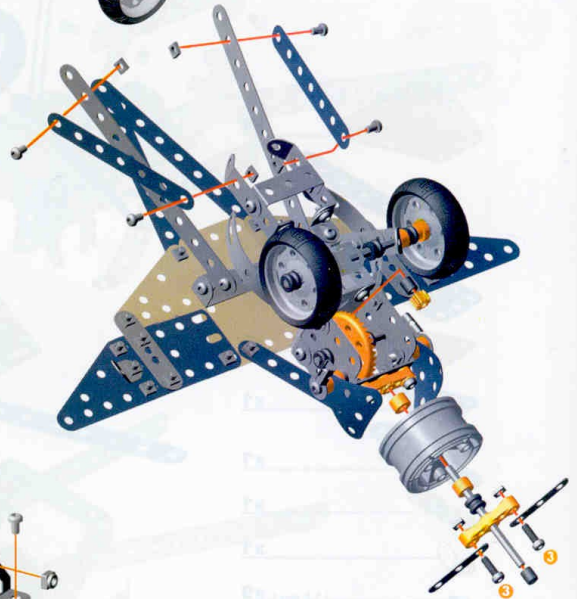

16



x2



x1



x2



x2



x1

| 19,2mm
3/4

x1

| 5,8 mm
15/64

x4



x4

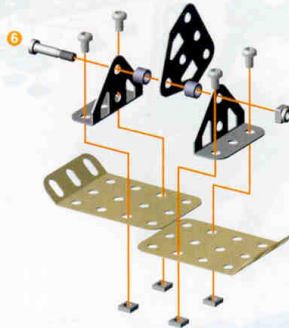

2

17



x2

| 12 mm
1/2

x1

| 5,8 mm
15/64

x2



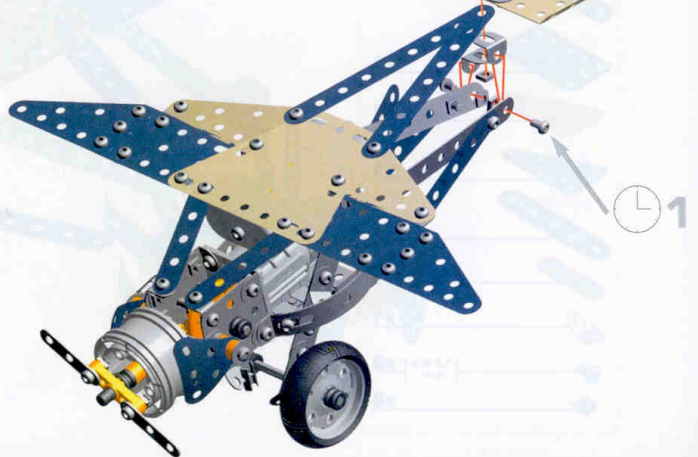

x3



1

18

-  | 14,7 mm | x1
9/16
-  | x1
-  | x1

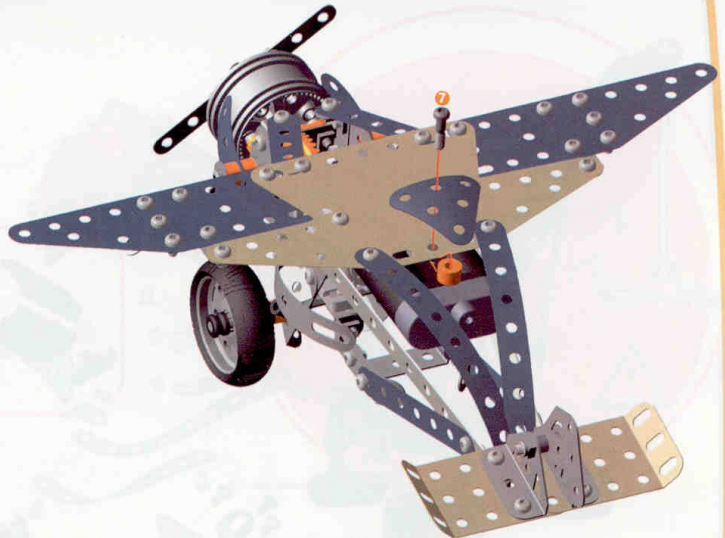

19

-  | 100 mm | x2
3 1/2
-  | x2
-  | x2







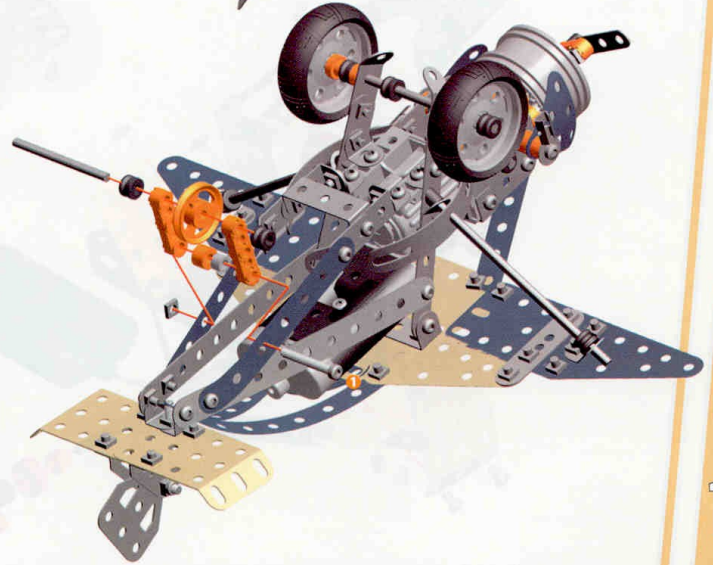







20

-  | 50 mm | x1
2
-  | x2
-  | x1
-  | 28 mm | x1
1 1/8
-  | x1
-  | x2
-  | x1
-  | x1









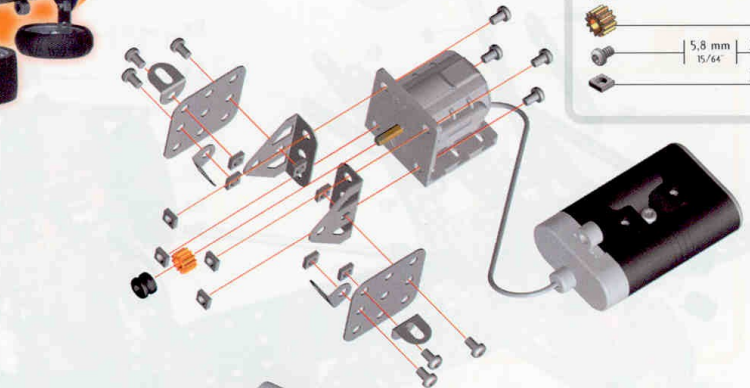

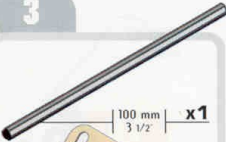



- 1**
-  x1
 -  x2
 -  x2
 -  x4
 -  x1
 -  x1
 -  x10
 -  x10







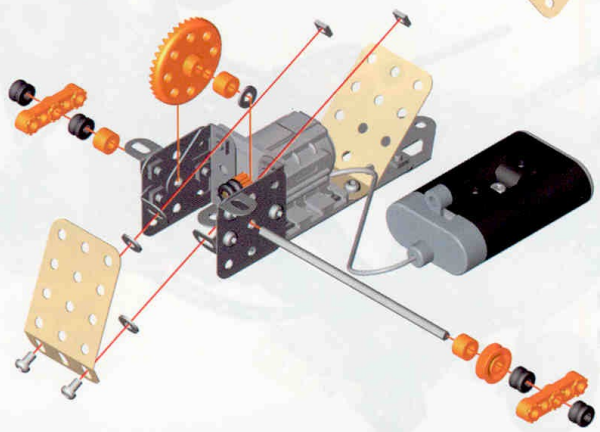

- 2**
-  x2
 -  x1
 -  x1
 -  5,8 mm x8
1 5/64"
 -  x8



- 3**
-  100 mm x1
3 1/2"
 -  x1
 -  x1
 -  x2
 -  x1
 -  x3
 -  x4
 -  x3
 -  5,8 mm x2
1 5/64"
 -  x2







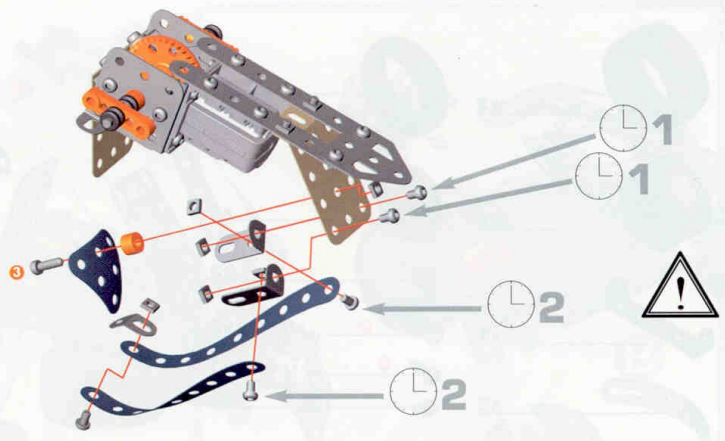

4

-  x2
-  x1
-  x2
-  x1
-  x1
-  12 mm | 1/2 | x1
-  5,8 mm | 15/64 | x5
-  x6



5

-  x2
-  x1
-  x2
-  x2
-  x2
-  5,8 mm | 15/64 | x5
-  x5

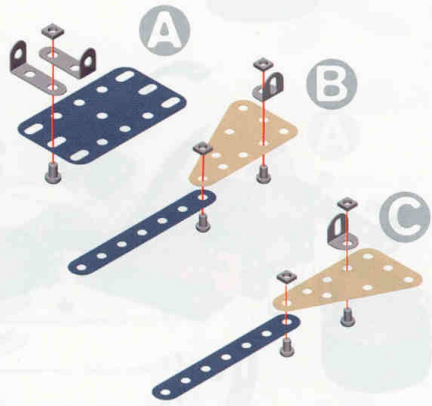

6

(4) + (5) +

-  50 mm | 2" | x1
-  x1
-  x2
-  12 mm | 1/2" | x1
-  5,8 mm | 15/64 | x2
-  x2

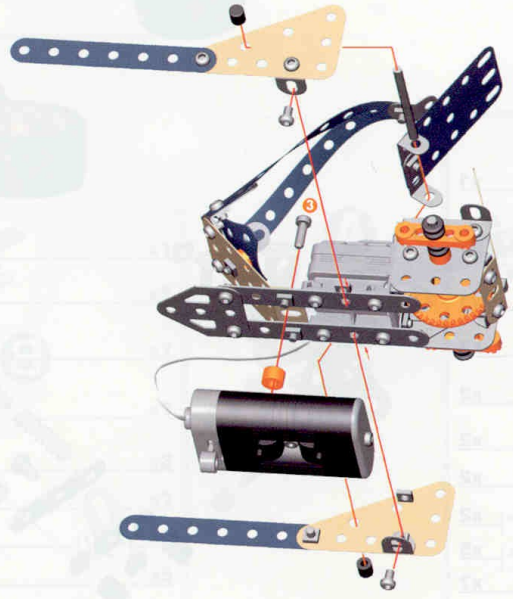

7

	x2		x1
	x2		x1
	x1		x2
	x2		x2
			x1
			x3

A X2

B

8

6 + 7 +

	x1
	x1
	x3
	x4

A

B

9







	x1
	x1
	x1
	x2
	x2
	x2
	x2
	x2
	x5
	x7

A

B







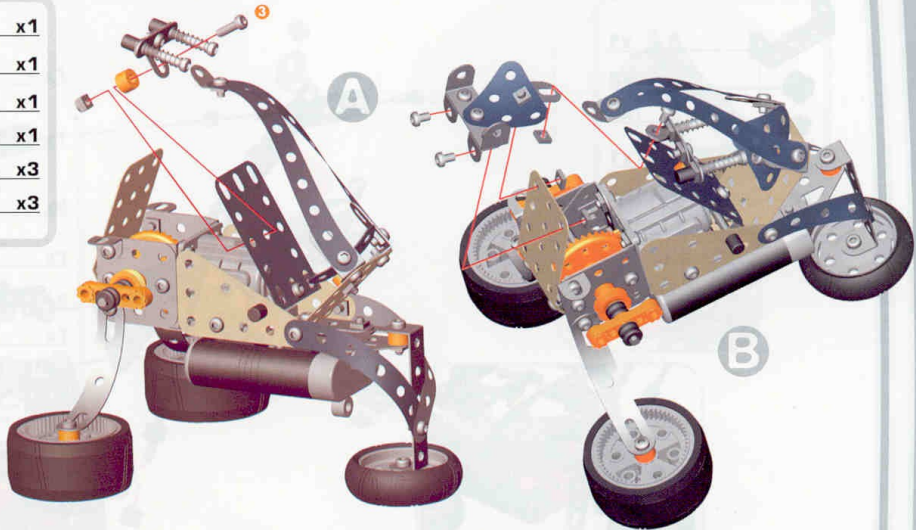

10

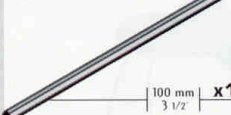
(8) + (9) +

	x1
	x1
	x1
 12 mm	x1
 5,8 mm	x3
 15/64	x3











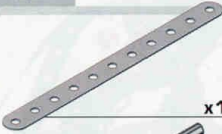
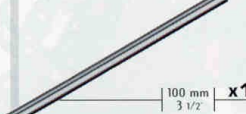



11

	x1
 100 mm	x1
 3 1/2	x1
	x1
	x1
	x1
	x1
	x1
 5,8 mm	x5
 15/64	x5



12

	x1
 100 mm	x1
 3 1/2	x1
	x1
	x1
	x1
	x1
	x1
	x1
	x2
	x1
 5,8 mm	x5
 15/64	x5

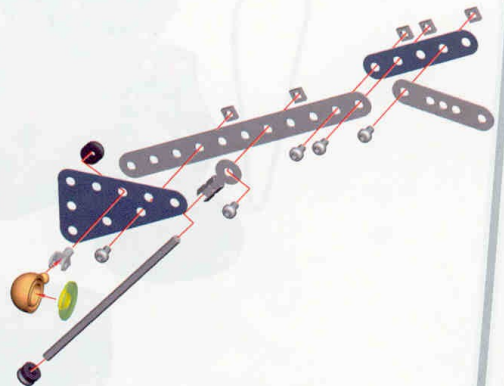

13

(10) + (11) + (12) +

	x1
	x2
	x2
	x1
	x4
	x5

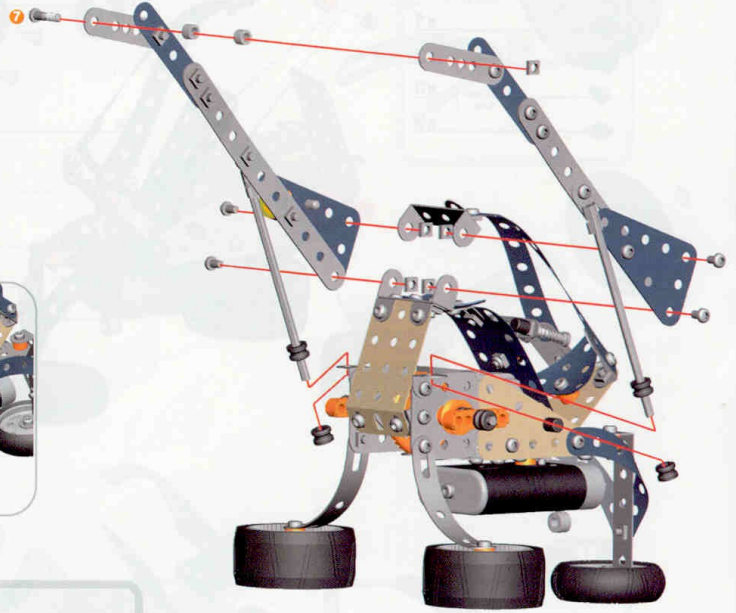
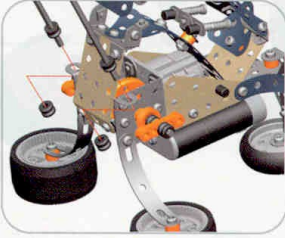





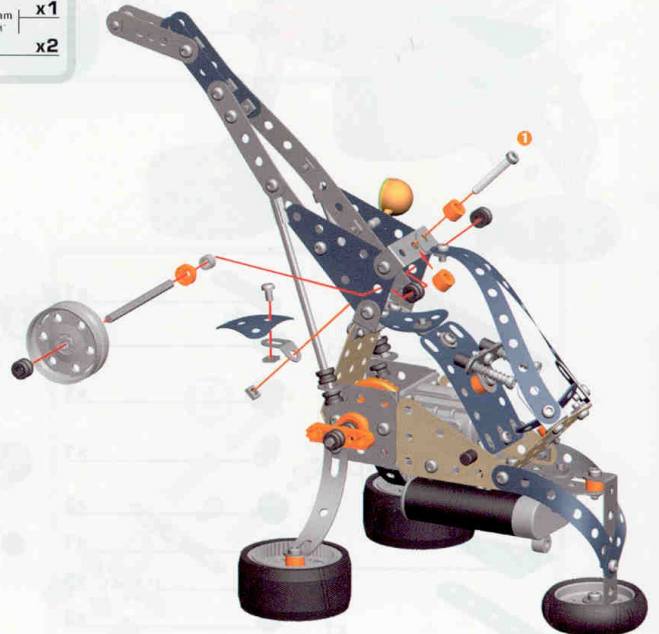



14

	x1		x3
	x1		x1
	x1		x2
	x1		x1
	x1		x1
	x1		x1
	x1		x2



15

(14)+

-  x1
-  x1
-  x4
-  x1
-  x2
-  x1
-  12 mm x1
-  5,8 mm 1/2" x2
-  5,8 mm 15/64" x2

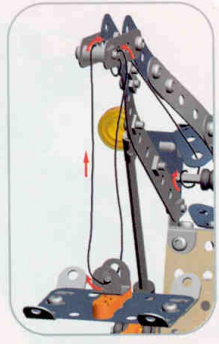
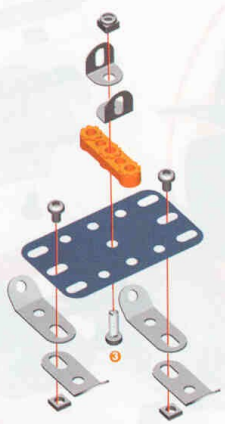

16

(14) + (15) +

-  x1

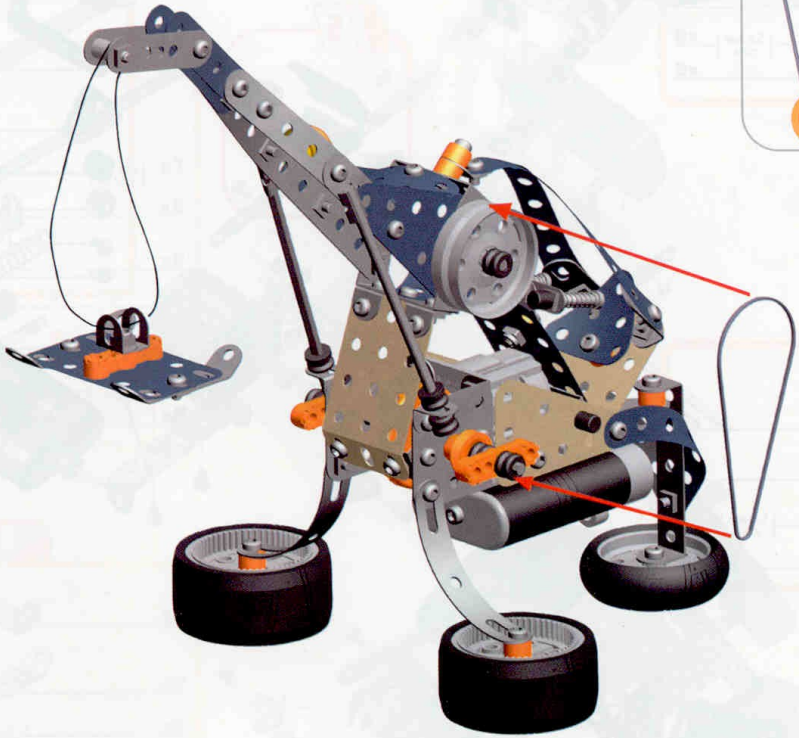
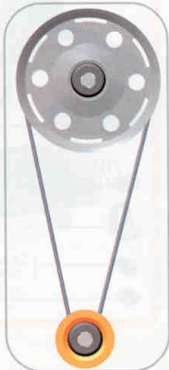

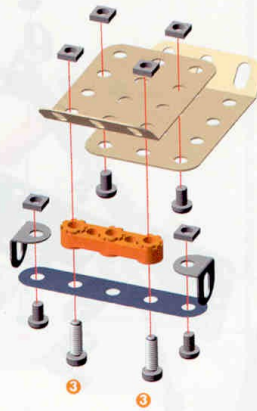
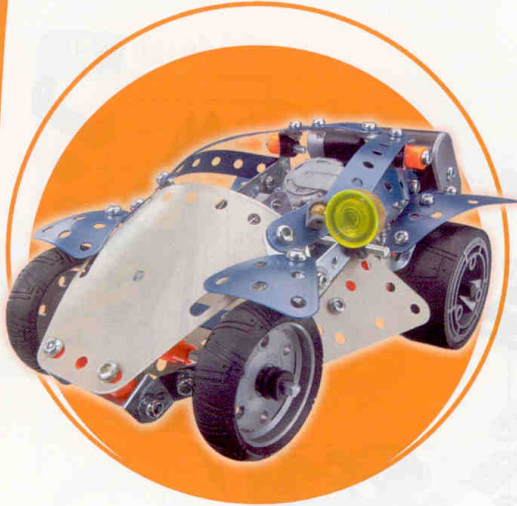

- 1**
- x2
 - x1
 - x1
 - x2
 - 12 mm 1/2" x2
 - 5,8 mm 15/64" x4
 - x6

- 2**
- x1
 - x1
 - x1
 - x2
 - 5,8 mm 15/64" x6
 - x6

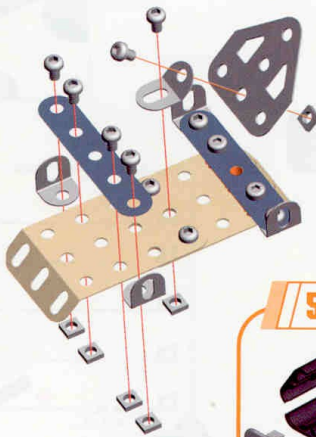





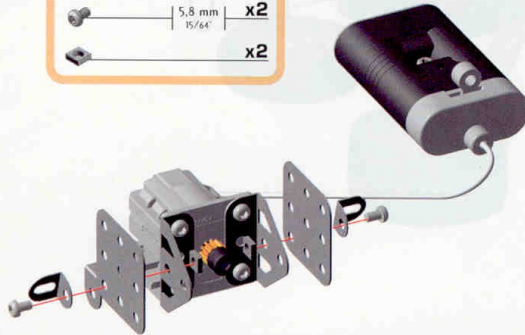
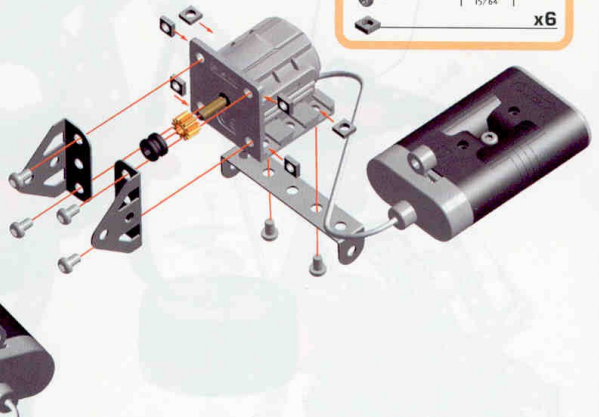

- 3**
- x1
 - x1
 - x2
 - x1
 - x1
 - 5,8 mm 15/64" x6
 - x6

- 4**
- x2
 - x2
 - 5,8 mm 15/64" x2
 - x2



5

-  x1
-  x1
-  x1
-  28 mm | 1 1/8" | x1
-  5,8 mm | 15/64" | x5
-  x6

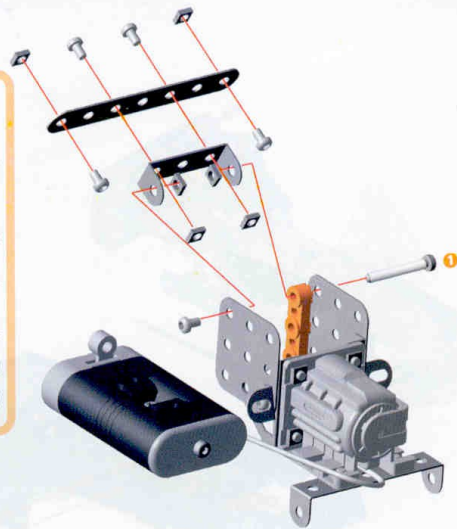





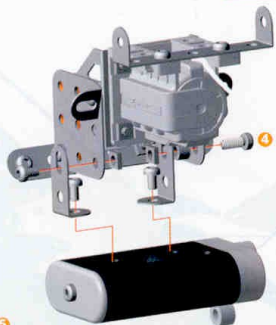

6

-  x2
-  x1
-  9,5 mm | 3/8" | x1
-  5,8 mm | 15/64" | x3
-  x2





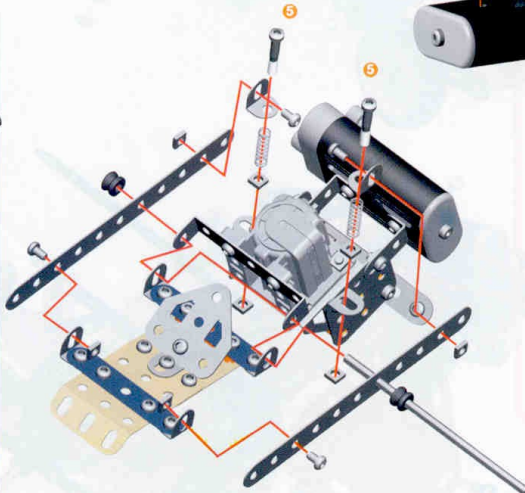

7

(2)+

-  x2
-  100 mm | 3 1/2" | x1
-  x2
-  x2
-  x2
-  23 mm | 29/32" | x2
-  5,8 mm | 15/64" | x4
-  x8



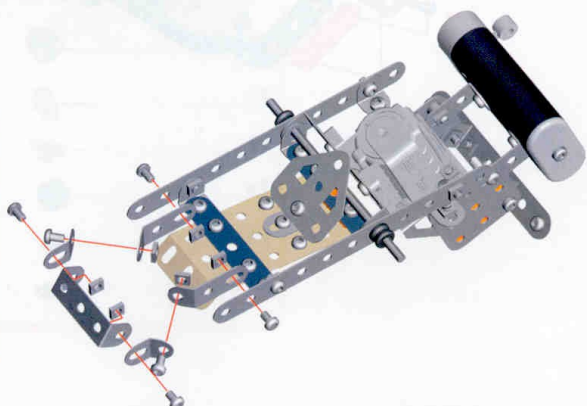

8

-  x1
-  x2
-  x2
-  5,8 mm | 15/64" | x6
-  x6







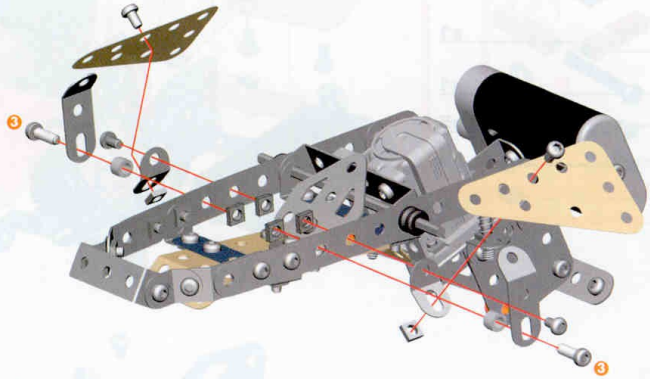



9

-  x2
-  x2
-  x2
-  x2
-  x2
-  x4
-  x6



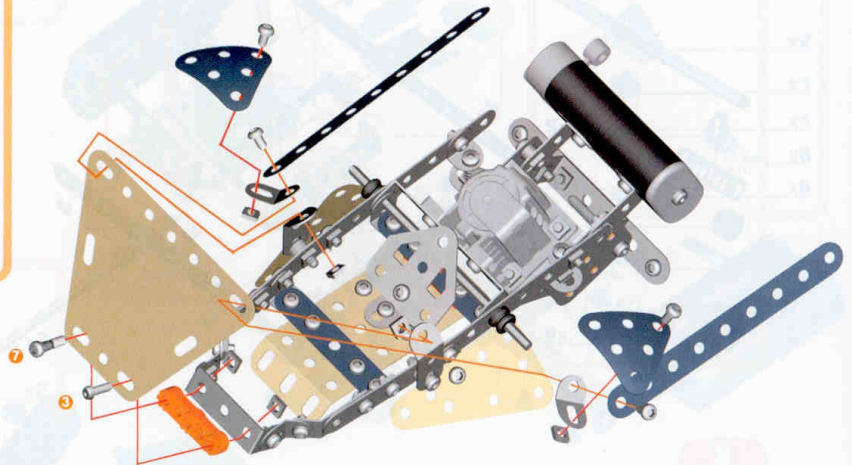

10

-  x1
-  x2
-  x2
-  x1
-  x2
-  x1
-  x1
-  x4
-  x6







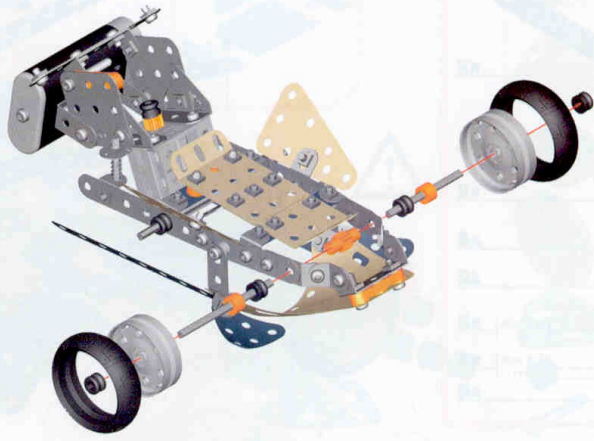

11

-  x2
-  x2
-  60 mm | 2 3/8" | x1
-  50 mm | 2" | x1
-  x1
-  x2
-  x4







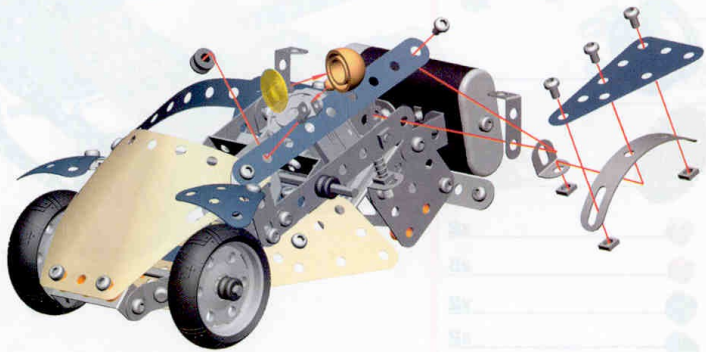
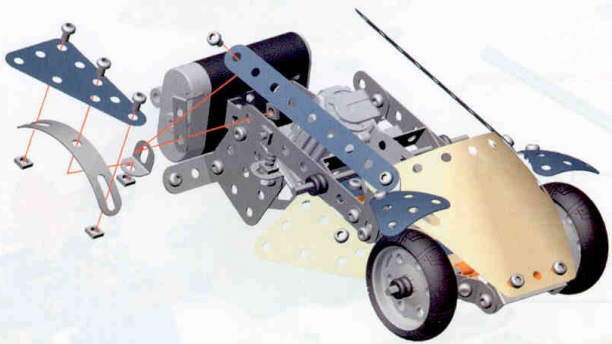





12









-  x1
-  x1
-  x1
-  x1
-  5,8 mm | 15/64" | x4
-  x4



13







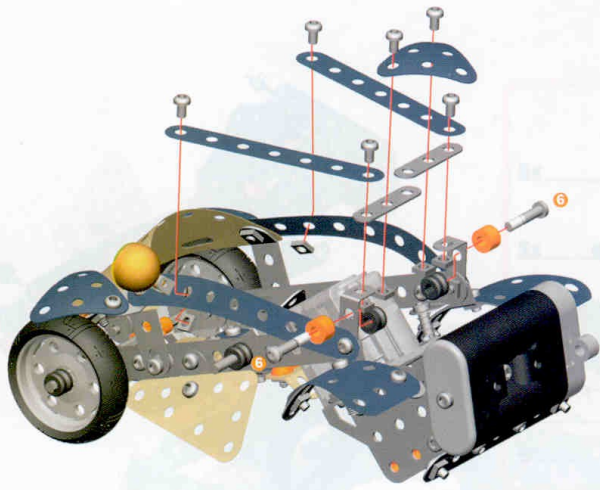

-  x1
-  x1
-  x1
-  x1
-  x1
-  x1
-  x1
-  x1
-  5,8 mm | 15/64" | x4
-  x4

14

-  x2
-  x1
-  x2
-  x2
-  x2
-  x2
-  x6
-  x6



15

-  x1
-  x2
-  x2
-  x1
-  x2
-  x5
-  x2
-  x2
-  x1

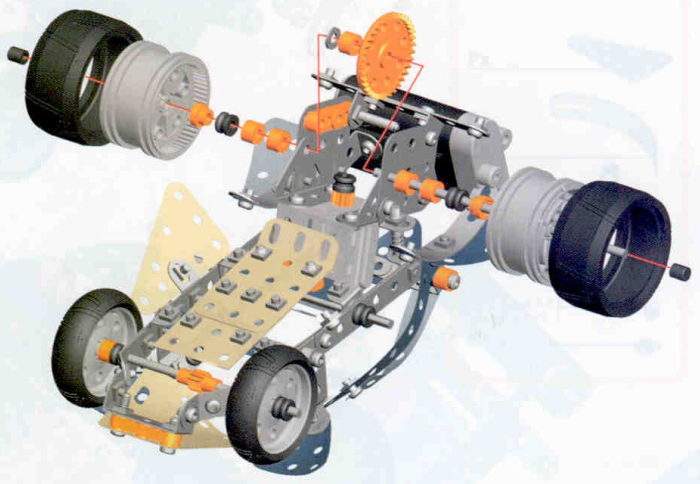



- 1**
- x1
 - x1
 - x1
 - x1
 - x1
 - x4
 - 23 mm
29/32 x1
 - 5,8 mm
15/64 x4
 - 5,8 mm
15/64 x4

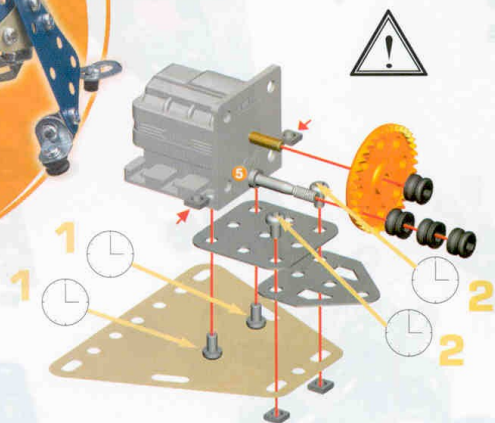

- 2**
- x2
 - x1
 - x1
 - 5,8 mm
15/64 x4
 - x3

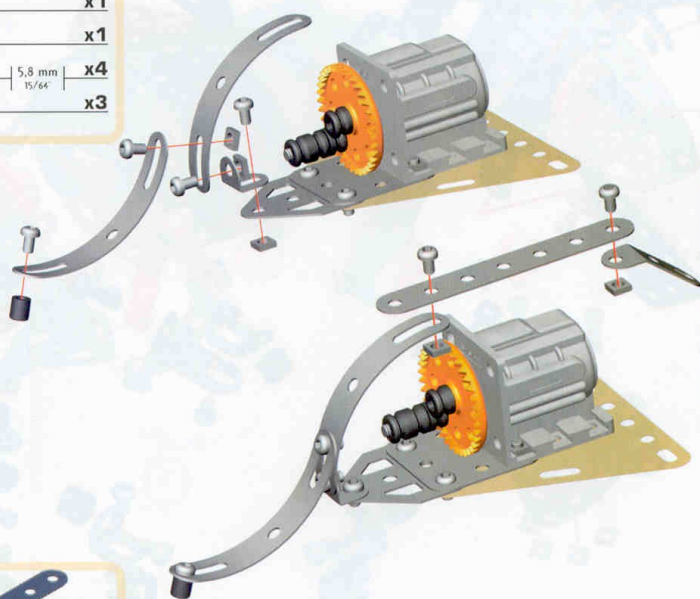



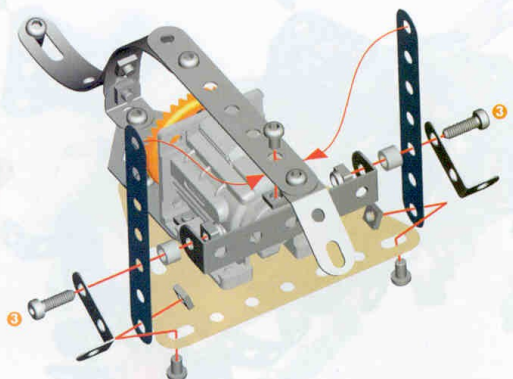

- 3**
- x1
 - x1
 - 5,8 mm
15/64 x2
 - x2



- 4**
- x2
 - x1
 - x2
 - x2
 - 12 mm
1/2 x2
 - 5,8 mm
15/64 x3
 - x3
 - x2



5

-  x2
-  x2
-  5,8 mm 15/64" x5
-  x5





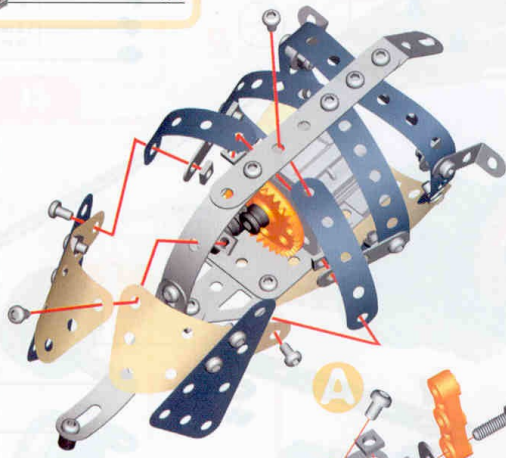

7

6+

-  x2
-  5,8 mm 15/64" x4
-  x4



6

-  x2
-  x2
-  5,8 mm 15/64" x4
-  x4



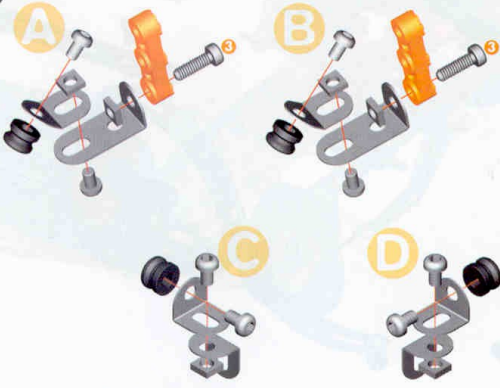

8

-  x2
-  x2
-  x2
-  x4
-  x4
-  12 mm 1/2" x2
-  5,8 mm 15/64" x8
-  x6





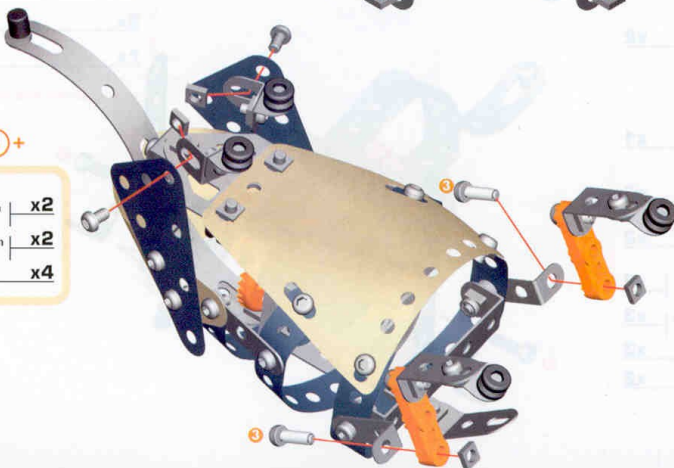

9

7+8+

-  12 mm 1/2" x2
-  5,8 mm 15/64" x2
-  x4



10

-  x2
-  x3
-  x2
-  5,8 mm 15/64 x5
-  x5

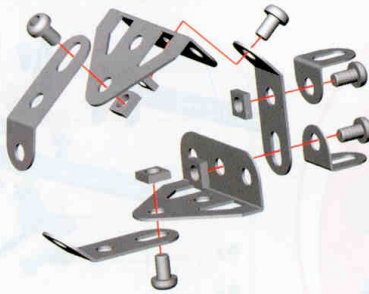



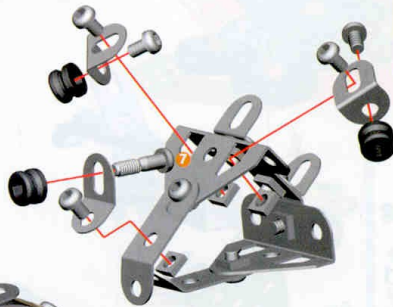

11

-  x1
-  x2
-  x3
-  14,7 mm 9/16 x1
-  5,8 mm 15/64 x5
-  x3





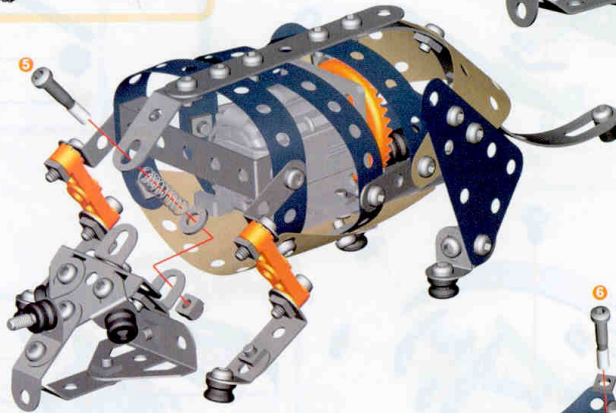

12

⑨ + ⑪+

-  ⑥ 23 mm 29/32 x1
-  x1
-  x1
-  x1





13

-  x3
-  ⑥ 19,2 mm 3/4 x2
-  5,8 mm 15/64 x2
-  x6



14

⑬+

-  5,8 mm 15/64 x1
-  x1

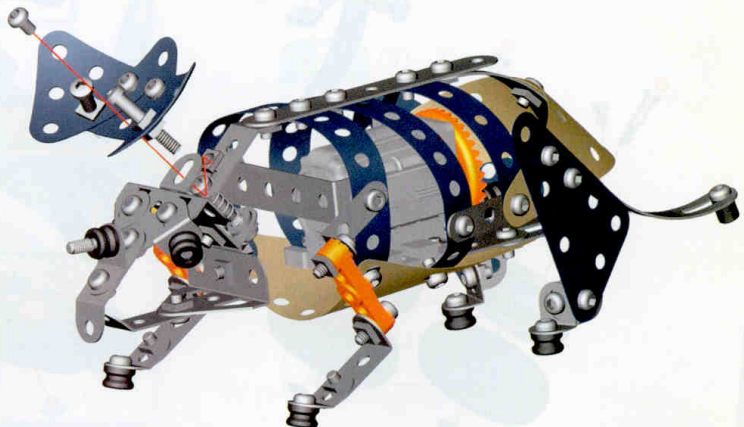

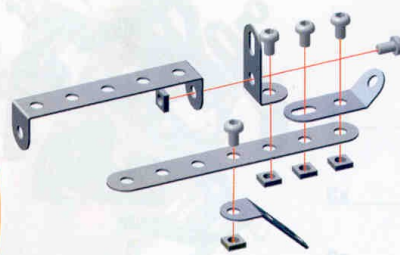

- 1**
- x1
 - x1
 - x2
 - x1
 - 5,8 mm 15/64 x5
 - 5,8 mm 15/64 x5

- 2**
- x2
 - x1
 - x1
 - x2
 - x1
 - x1
 - 5,8 mm 15/64 x3
 - 5,8 mm 15/64 x3



- 3**
- x1
 - 60 mm 2 3/8 x1
 - x3
 - x2

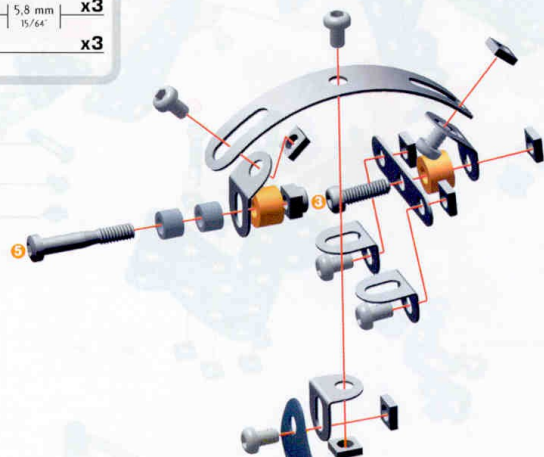

- 4**
- x1
 - x2
 - x2
 - x1
 - x1
 - 23 mm 29/32 x1
 - x1
 - 12 mm 1/2 x1
 - x2
 - 5,8 mm 16/64 x6
 - x3
 - x7



- 5**
- x2
 - x2
 - x2
 - x1
 - x2
 - x2
 - 19,2 mm 3/4 x2
 - 5,8 mm 15/64 x2
 - x4

6

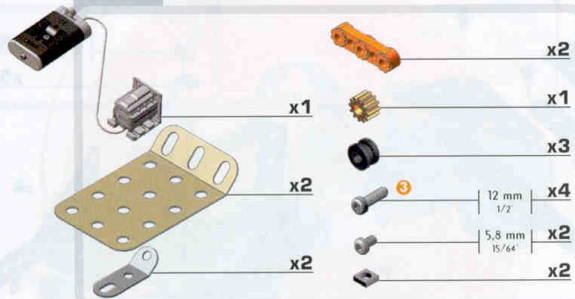

5

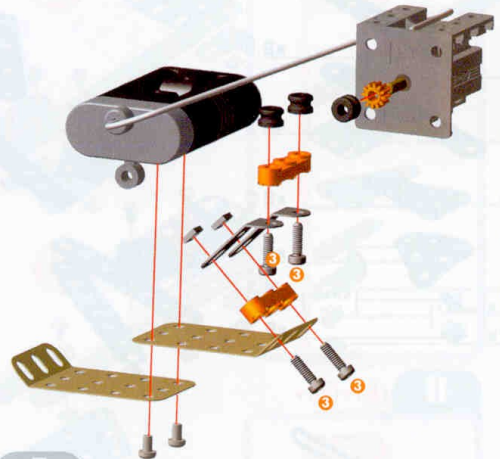

7

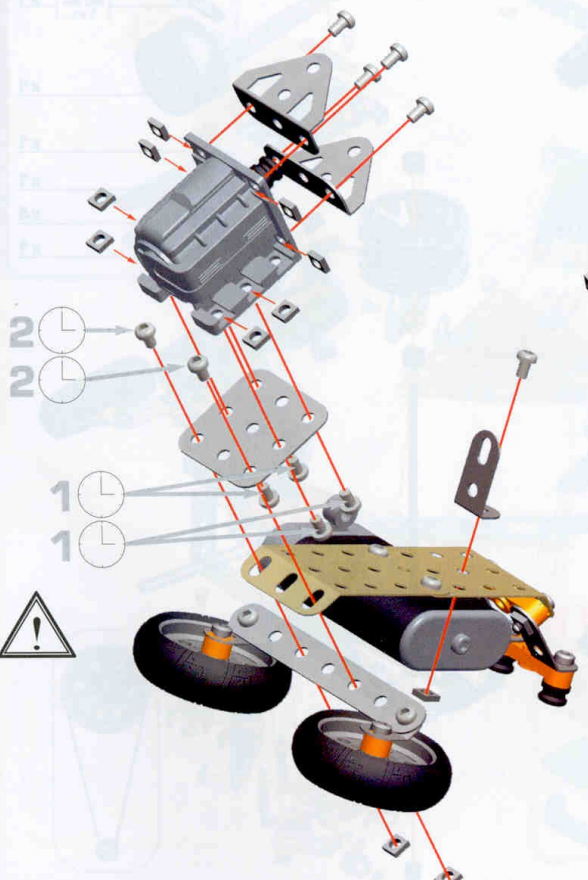
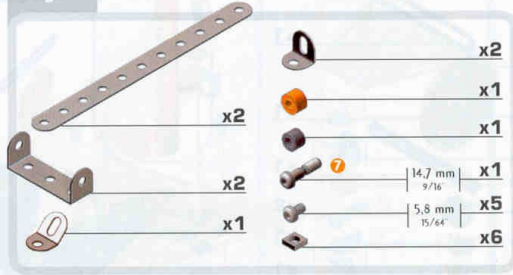





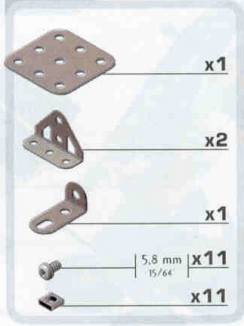

8

5 + 6 +



9

-  x2
-  x2
-  x2
-  x1
-  x6
-  x6

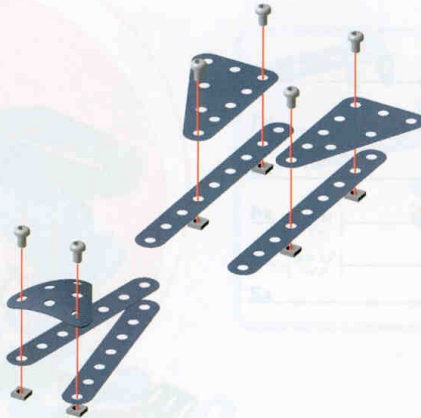

10



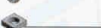

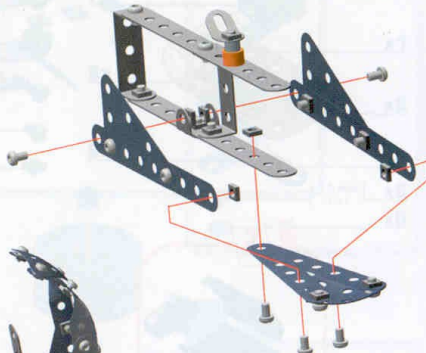

7 + 9 +

-  x5
-  x5

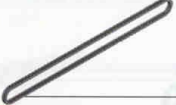







11

8 + 10 +

-  x1
-  x1
-  x1
-  x2
-  x1
-  x1
-  x1



12

-  x1
-  x1
-  x1
-  x1
-  x4
-  x1

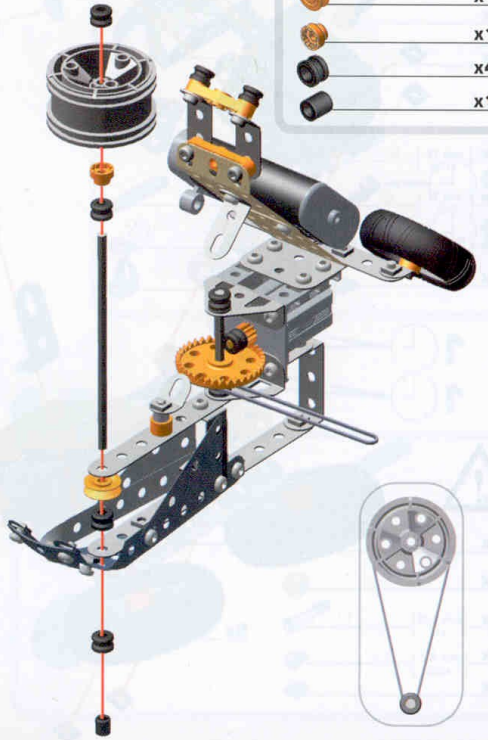

13

3 + 4 +

-  x1
-  x2
-  x1
-  x1
-  x2
-  x2

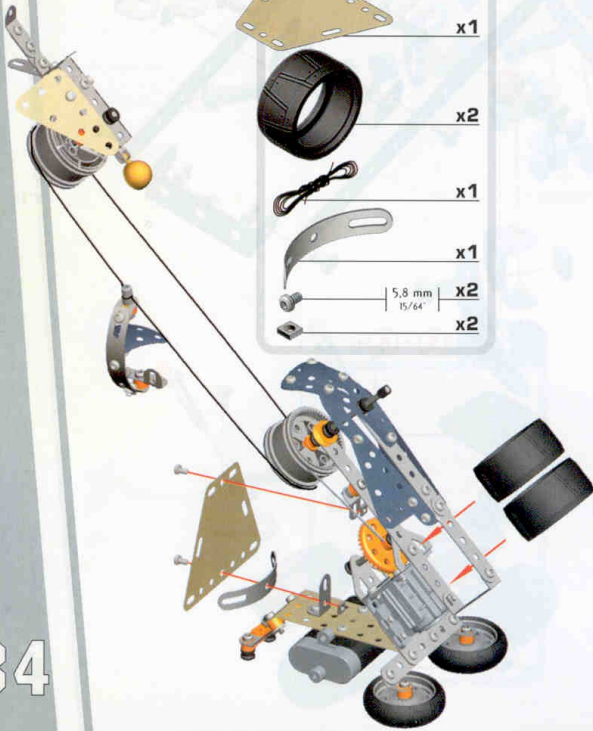

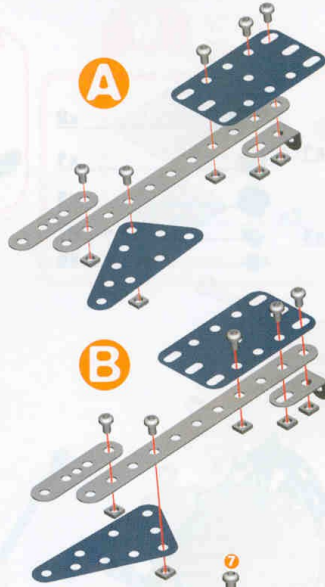
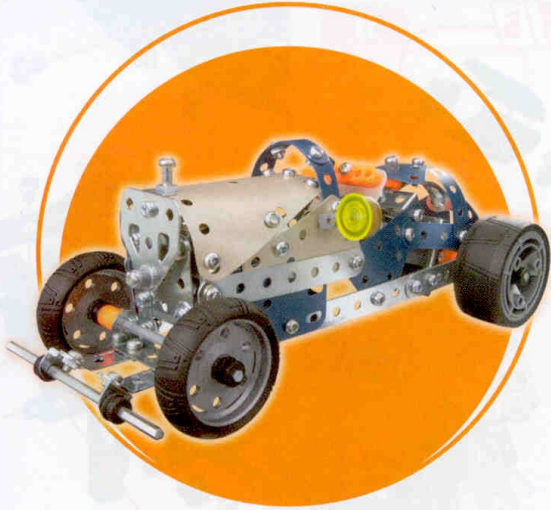

- 1**
- x2
 - x2
 - x2
 - x2
 - x2
 - 5,8 mm x10
 - 15/64 x10

- 2**
- x2
 - x2
 - x2
 - 5,8 mm x6
 - 15/64 x6

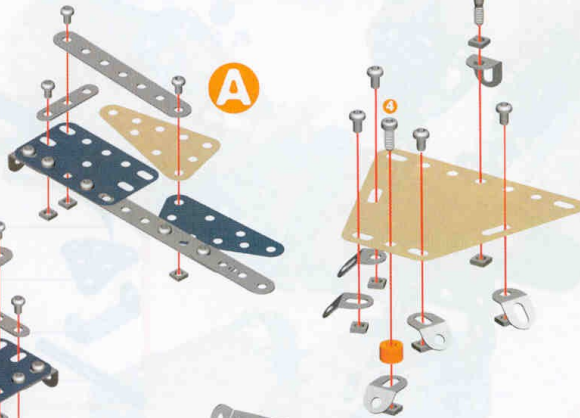

- 3**
- x1
 - x5
 - x1
 - x1
 - 14,7 mm x1
 - 9,76 x1
 - 9,5 mm x1
 - 3/8 x4
 - 5,8 mm x7
 - 15/64



- 4** ②+③+
- x1
 - x2
 - x1
 - x1
 - 12 mm x1
 - 1/2 x1
 - 5,8 mm x9
 - 15/64 x10

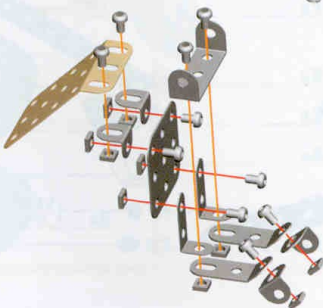

- 5**
- x1
 - x1
 - x1
 - x2
 - x2
 - x4
 - 5,8 mm x10
 - 15/64 x10

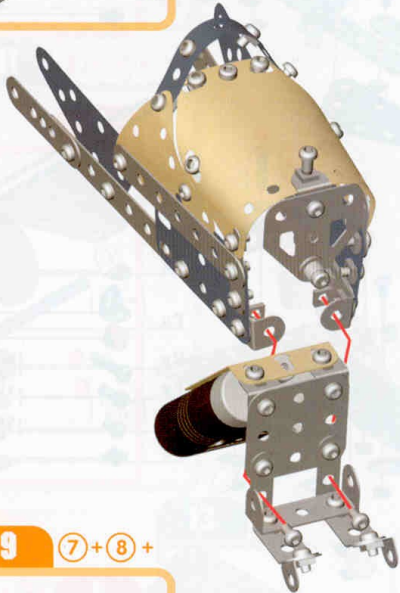
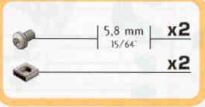
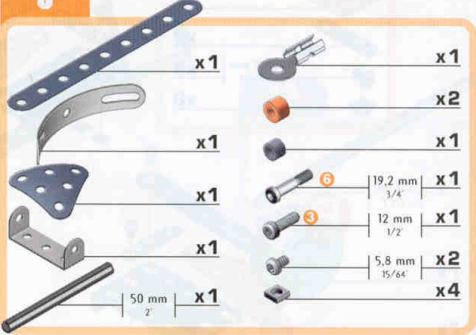
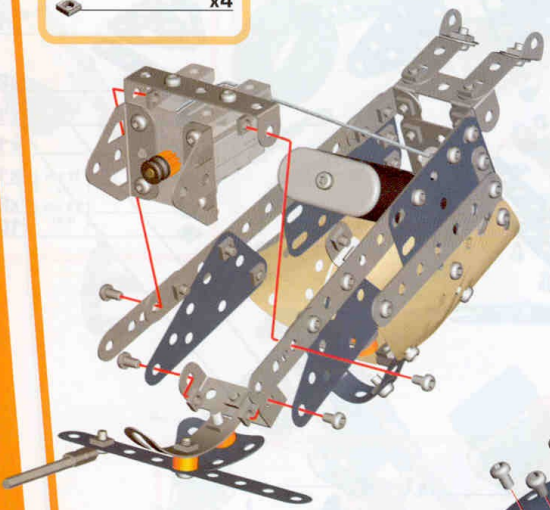
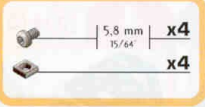
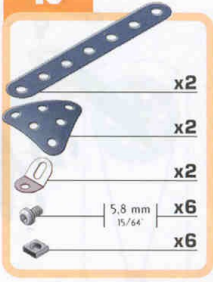
6**5+****5****7****4+6+****8****9****7+8+****10**

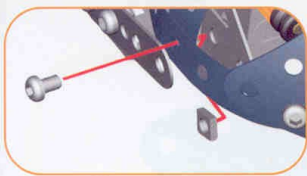

11

- | 5,8 mm | x4
- | x4

12

11 + 12 +

- | x1
- | x1
- | x1
- | x1
- | 12 mm | x1
- | 1/2" | x1
- | 5,8 mm | x3
- | 15/64" | x4

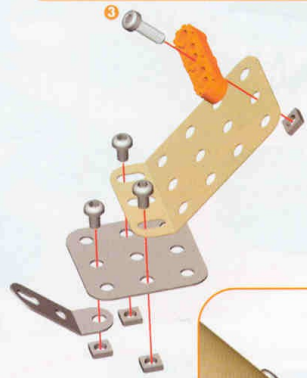
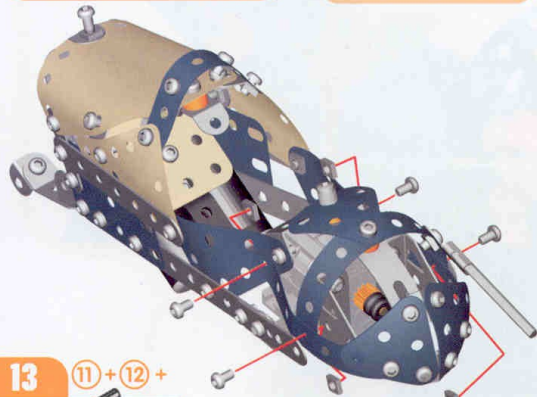

13

11 + 12 +

- | 60 mm | x1
- | 2 3/8" | x1
- | x1
- | x1
- | x1
- | x1
- | x3
- | x1
- | 5,8 mm | x1
- | 15/64" | x1

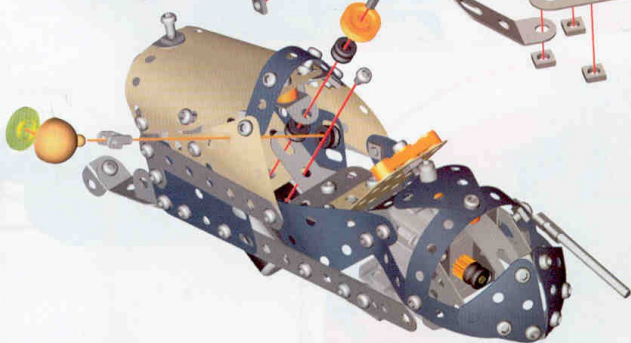

14

- | 100 mm | x2
- | 3 1/2" | x2
- | x2
- | x2
- | x4
- | x6

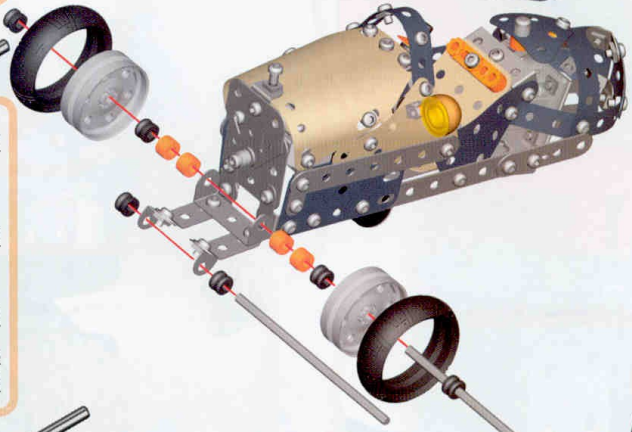

15

- | 130 mm | x1
- | 3 1/2" | x1
- | x2
- | x2
- | x3
- | x4
- | x2
- | x2
- | x1
- | x1
- | x2
- | x3
- | x4
- | x2
- | x1

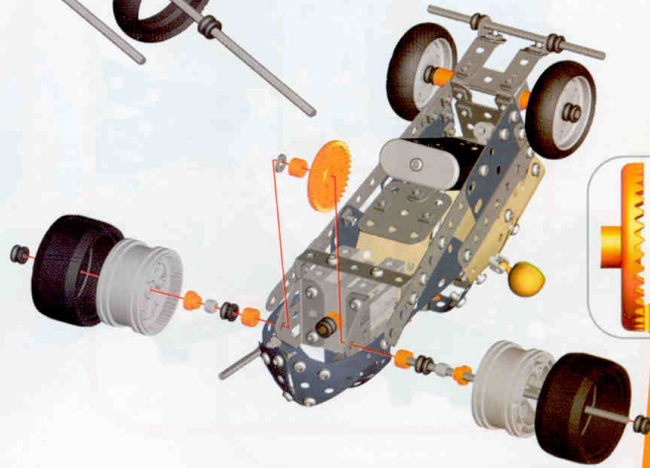

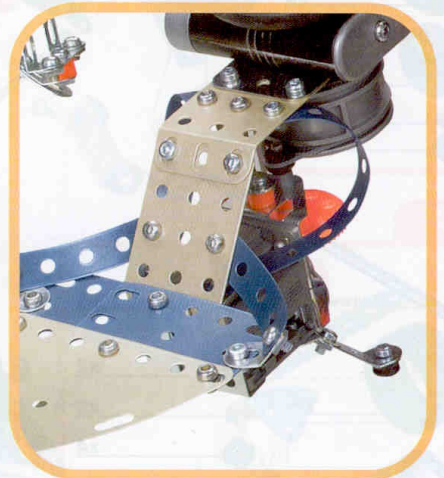
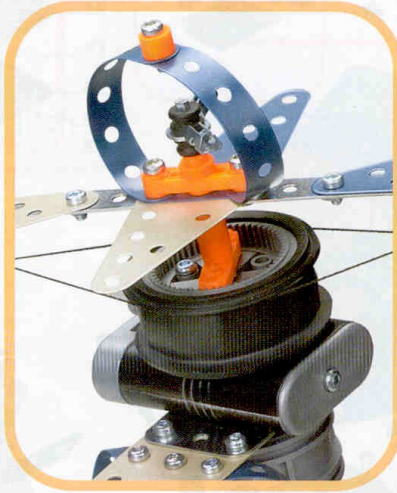

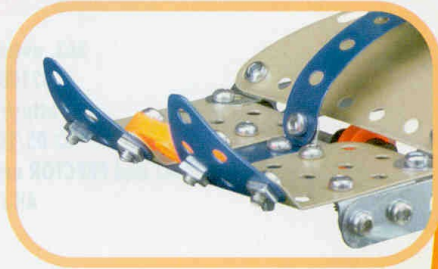
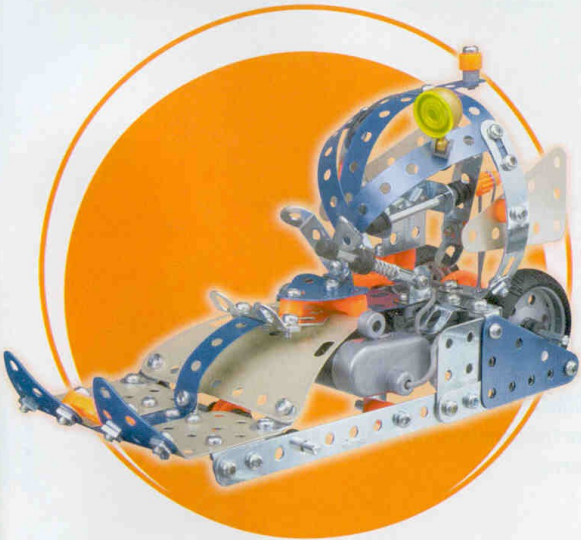
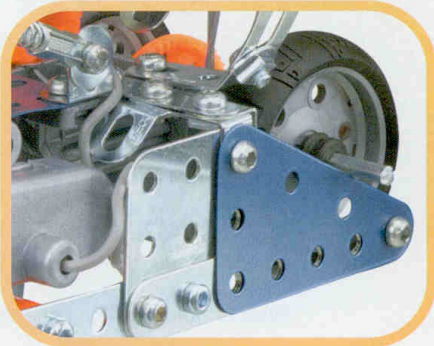
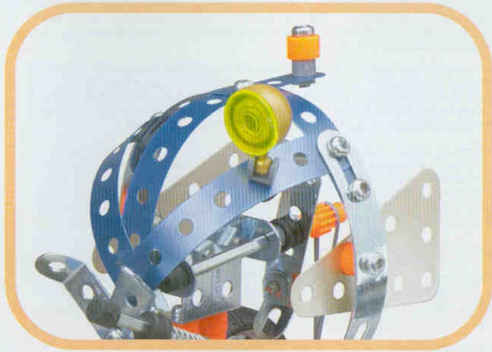

GB Many of the models and component parts are unique and original designs which are the property of MECCANO S.N. They are protected by national legislation as industrial designs, trademarks and/or copyrights throughout many countries. For detailed information, please contact: MECCANO S.N. Meccano S.N. shall have no responsibility for (I) failure to follow instructions, (II) use of parts for any purpose other than as specified in the instructions (III) any alteration of any parts or components. MECCANO S.N. respects children's safety: all models are tested by children.

F De nombreux modèles et pièces sont des créations originales, propriétés de MECCANO S.N. et sont protégés par les législations nationales sur les dessins et modèles, marques et/ou droits d'auteurs. Pour toute information, merci de contacter : MECCANO S.N. La responsabilité de MECCANO S.N. ne saurait être engagée en cas d'accident survenu à la suite (I) du non respect des instructions de montage (II) d'une utilisation des pièces autre que celle proposée dans la notice (III) d'une altération ou de la modification des pièces. La société MECCANO respecte la sécurité des enfants : ses modèles sont testés par des enfants.

D Zahlreiche Modelle und Teile sind Erfindungen und Eigentum der Firma MECCANO S.N. Sie sind durch Inland-Gesetze über Zeichnungen und Modelle sowie Warenzeichen und/oder Urheberrechte geschützt. Für zusätzliche Auskünfte wenden Sie sich bitte an: MECCANO S.N. Die Firma Meccano S.N. haftet nicht für Unfälle, die aus der (I) Nichtbeachtung der Bauanleitung, der (II) Verwendung anderer als in der Bauanleitung angegebenen Teile oder der (III) Änderung oder Modifikation der Teile resultieren. Alle Modelle der Firma Meccano wurden von Kindern getestet und entsprechen den Sicherheitsnormen.

I Numerosi modelli e pezzi sono creazioni originali della MECCANO S.N. e sono protetti dalle legislazioni nazionali sui disegni e modelli, marche e/o diritti d'autore. Per qualsiasi informazione, vogliate prendere contatto con: MECCANO S.N. Meccano S.N. declina ogni responsabilità in caso d'incidenti sopravvenuti in seguito (I) a: non rispetto delle istruzioni di montaggio (II) utilizzo dei pezzi per funzioni diverse da quelle previste nel manuale (III) alterazione e/o modifica dei pezzi. La società MECCANO rispetta la sicurezza dei bambini : i suoi modelli vengono testati dai bambini stessi.

E Numerosos modelos y piezas son creaciones originales, propiedades de MECCANO S.N. y están protegidos por las legislaciones nacionales en lo que concierne a los dibujos y modelos, marcas y/o derechos de autor. Para cualquier información, sírvase ponerse en contacto con: MECCANO S.N. MECCANO S.N. carece de responsabilidad en caso de accidente debido a: (I) el incumplimiento de las instrucciones de montaje (II) una utilización de las piezas diferente a la que se indica en las instrucciones (III) una alteración o modificación de las piezas. La sociedad MECCANO respeta la seguridad de los niños : sus modelos están probados por niños.

P Vários modelos e peças são criações originais, propriedades da MECCANO S.N. e são protegidos pelas legislações nacionais relativas aos desenhos e modelos, a marcas e/ou aos direitos de autor. Para qualquer informação, é favor contactar : MECCANO S.N. A Sociedade MECCANO S.N. não poderá ser responsabilizada pelos acidentes provocados: (I) pelo falha de cumprimento das instruções de montagem (II) pelo uso indevido das peças ou (III) pela modificação ou alteração das peças. A Sociedade MECCANO respeita a segurança das crianças : os seus modelos foram testados por crianças.

S Många modeller och delar bildar en unik och originell formgivning vilken är MECCANO S.N. egendom. Dessa modeller och delar är skyddade genom lagstiftning såsom industriell formgivning, varumärke och/eller

GB Standard batteries must not be recharged. Rechargeable batteries must be removed from the toy before being recharged (if it is possible to remove them). Rechargeable batteries must only be recharged under adult supervision (if it is possible to remove them). Do not mix different types of batteries together or new with old rechargeable / non rechargeable batteries. Only batteries of the recommended type or a similar type should be used. Batteries must be fitted in accordance with their instructions. Remove used batteries from the toy. Battery terminals must not be short-circuited. Please keep instructions.

F Les piles ne doivent pas être rechargées. Les accumulateurs doivent être enlevés du jouet avant d'être chargés (s'il est possible être enlevés). Les accumulateurs ne doivent être chargés que sous la surveillance d'un adulte (s'il est possible être enlevés). Différents types de piles ou accumulateurs ou des piles ou chargeurs neufs et usagés ne doivent pas être mélangés. Seul des piles ou accumulateurs du type recommandé ou d'un type similaire doivent être utilisés. Les piles et accumulateurs doivent être mis en place en respectant la polarité. Les piles et accumulateurs usagés doivent être enlevés du jouet. Les bornes d'une pile ou d'un accumulateur ne doivent pas être mises en court-circuit. Indications à conserver.

D Die Batterien dürfen nicht wieder aufgeladen werden. Die Akkus müssen vor dem Nachladen aus dem Spielzeug genommen werden (wenn sie ausgebaut werden können). Die Akkus dürfen nur unter Aufsicht eines Erwachsenen nachgeladen werden (wenn sie ausgebaut werden können). Unterschiedliche Arten von Batterien und Akkus oder neue und gebrauchte Batterien bzw. Akkus dürfen nicht zusammen verwendet werden. Es dürfen nur Batterien bzw. Akkus der empfohlenen Art oder einer ähnlichen Art verwendet werden. Beim Einsetzen der Batterien bzw. Akkus auf die richtige Polung achten. Verbrauchte Batterien bzw. Akkus bitte aus dem Spielzeug entfernen. Die Klammern der Batterien bzw. Akkus dürfen nicht kurzgeschlossen werden. Diese Anweisungen bitte abwarten.

I Le pile non devono essere ricaricate. Gli accumulatori devono essere tolti dal giocattolo prima di essere caricati (se è possibile toglierli). Gli accumulatori devono essere caricati sotto la sorveglianza di un adulto (se è possibile toglierli). Non possono essere mescolati tipi diversi di pile o di accumulatori oppure pile o accumulatori nuovi e usati. Si devono usare solo pile o accumulatori del tipo raccomandato o di un tipo simile. Le pile e gli accumulatori devono venire sistemati rispettando la polarità. Le pile e gli accumulatori usati devono essere tolti dal giocattolo. I morsetti di una pile o di un accumulatore non devono essere messi in cortocircuito. Conservare queste istruzioni.

E Las pilas no deberán recargarse. Habrá que retirar las acumuladoras del juguete antes de proceder a recargarlas (si es que pueden retirarse). Los acumuladores sólo se recargaran bajo la vigilancia de una persona adulta (si es posible retirarlos). No deberán mezclarse diferentes tipos de pilas o acumuladoras o de pilas o acumuladoras nuevas y usadas. Sólo se utilizarán pilas o acumuladoras del tipo recomendado o de un tipo similar. Las pilas y acumuladoras deberán colocarse respetando la polaridad. Deberán retirarse del juguete las pilas y acumuladoras usadas. Lors bornes de una pile o de un acumulador no deberán ponerse nunca en posición de cortocircuito. Conservar estas indicaciones.

P As pilhas não devem ser novamente carregadas. Os acumuladores devem ser removidos do brinquedo antes de serem carregados (caso possam ser removidos). Os acumuladores devem ser carregados apenas sob cuidados de um adulto (caso possam ser removidos). Diferentes tipos de pilhas ou acumuladores ou pilhas ou acumuladores novos já utilizados não devem ser misturados. Pilhas ou acumuladores do tipo recomendado ou de um tipo similar poderão ser utilizados. As pilhas e acumuladores devem ser inseridos, respeitando a polaridade. Devem ser removidos do brinquedo as pilhas e acumuladores já utilizados. Os pólos de uma pilha ou de um acumulador não devem ser curto-circuitados. Indicações a conservar.

S Batterierna skall inte laddas om. Akkumulatorterna skall tas av från lekset innan de laddas (om de kan tas av). Akkumulatorterna skall endast laddas under uppsikt av en vuxen (om de kan tas av). Olika typer av batterier eller akkumulatortyper skall inte blandas. Nytt och använda batterier eller akkumulatortyper skall inte blandas. Använd endast rekommenderade typer eller likartade typer av batterier eller akkumulatortyper. Batterier och akkumulatortyper skall sättas i med hänsyn till polaritet. Använda batterier och akkumulatortyper skall tas av från lekset. Kontakterna på ett batteri eller ett

uppspömsmanöritt i ett flertal länder. För mer detaljerad information, var vänlig och kontakta MECCANO S.N. MECCANO S.N. fräntar sig allt ansvar i händelse av olycka till följd av (I) att monteringsinstruktionerna inte har respekterats (II) en annan användning av delarna än den står i anvisningen (III) en försvämning eller förändring av delarna. Företaget MECCANO respekterar barnsäkerheten : modellerna har testats av barn.

FIN Usat mallit ja osat ovat MECCANO S.N. omaisuutta ja/tai alkuopettajien suunnitelmia. Ne ovat kansallisia lailla suojattua teollista tuotantoa, tavaramerkkejä ja/tai kopiointioikeuksia. Pyydämme ottamaan yhteyden MECCANO S.N. ha kaikissa asioissa liittyvissä kysymyksissä. MECCANO S.N. ei vastaa eikä kato seuraavista syistä sattuneista onnettomuuksista: (I) ohjeiden väärintulkinnasta, (II) muiden kuin ohjeissa ehdotettujen osien käytöstä, (III) osien muuttamisesta tai tarkoituksensa käyttä. MECCANO-yhtiö huolehtii lasten turvallisuudesta: lapset ovat testanneet mallimme.

DK Vore mange modeller og dele er originale framstillinger og ejes af MECCANO S.N. Tegninger, modeller, fabrikationsmærker og øvravart er lovskyttede i hvert land. Yderligere oplysninger kan fås hos MECCANO S.N. MECCANO S.N. frastiger sig ethvert ansvar, såfremt der er sket ulykke forårsaget af (I) at monteringsinstruktionerne ikke er blevet overholdt, (II) at delene er blevet brugt til andre formål, end dem der er beskrevet i betjeningsvejledningen, (III) eller at delene er blevet beskadiget eller ændret. MECCANO overholder sikkerhedsreglerne for børn: Alle modeller testes af barn.

NL Veel modellen en onderdelen zijn origineel ontwerpen en eigendom van MECCANO S.N. en worden beschermd door de nationale wetgevingen op het aankomen van modellen, merken en/of auteursrechten. Voor informatie gelieve contact op te nemen met MECCANO S.N. De verantwoordelijkheid van MECCANO S.N. is uitgesloten in geval van ongevallen voortkomend uit het niet naleven van de montage-instructies (I), uit het gebruik van andere onderdelen dan die zoals vermeld in de handleiding (II) of uit het veranderen of modificeren van de onderdelen (III). De firma MECCANO neemt de veiligheid van de kinderen in acht : de modellen zijn door kinderen getest.

GR Πολλά μοντέλα και ανταλλακτικά είναι ανεπτυχθέντα, δικαιώματα της MECCANO S.N. και προστατεύονται από τις εθνικές νομοθεσίες για τα μοντέλα της μαρκας, ή τα δικαιώματα εφευρεσίας. Για κάθε πληροφορία παρακαλώ απευθύνεσθε στη MECCANO S.N. Η ευθύνη της MECCANO S.N. δεν άσειμαίεται σε περίπτωση ατυχημάτων που έγινε συνέπεια (I) μη σεβασμού των οδηγιών, συναρμολόγησης (II) χρήσης των τμημάτων διαφορετικά από αυτήν που προτείνεται στις οδηγίες (III) καταστροφή ή αλλαγή των τμημάτων. Η εταιρεία MECCANO ελέγχει την ασφάλεια των παιδιών: τα μοντέλα της δοκιμάζονται από παιδιά.

JPN モデルならびに部品は、その多くが MECCANO 社所有のオリジナル・デザインで、特許、商標をはじめ、または著作権に関する国内法によって保護されています。詳細については、弊社 (MECCANO S.N.) までお問い合わせください。MECCANO S.N. は、事故や故障の原因となった場合、(I) 使用説明書に記載されたもの以外の部品を使用した場合、(II) 部品を改造・改修した場合など起きた事故については責任を負うことはできません。メガノ社の全モデルは事前に子들에게によりテストを行い、その安全性を確認されています。

akkumulatorteri skall inte kortslutas. Bevara anvisningarna.

FIN Paristajo ei saa ladata uudelleen. Akun otettava ulos leikkittävältä lannoitaimelta (jos se on mahdollista). Akut saa ladata vain aikuisen valvonnassa (jos ne voidaan ottaa ulos). Erityisesti paristajo tai akkuja ei saa käyttää yhdessä, samoin ei saa sekoittaa akkuja ja ussia ja vanhoja paristoja. Vain suositeltuja akku- tai paristotyyppejä saa käyttää tall tyyppeä, samoin ei saa omaisuudet. Paristo ja akut on otettava poikkeillen min, että navat tulevat oikeisiin suuntiin. Lopputuokäyttöä paristot tai akut on otettava leikkittävältä ulos. Akun tai pariston paristoja ei saa osakuokella. Ohjeet on pidettävä tallessa.

DK Batterierne må ikke oplades. Akkumulatortermie skal toges ud af legetøjet, inden de lades op (hvis de kan toges ud). Akkumulatortermie må kun lades op under opsyn af voksne (hvis de kan toges ud). Forskellige typer batterier og akkumulatortermie, eller nye og brugte batterier, må ikke blandes sammen. Der må kun anvendes batterier eller akkumulatortermie af den type der er anbefalet eller tilsvarende modeller. Batterier og akkumulatortermie skal vendes rigtigt (+/- polaritet). Brugte batterier og akkumulatortermie skal toges ud af legetøjet. Klammere på et batteri eller et akkumulatortermie må ikke kortslutas. Disse instruktioner bør opbevares.

NL De batterijen mogen niet weer opgeladen worden. De accu's moeten voor het laden uit het spelgoed verwijderd worden (indien ze verwijderd kunnen worden). Gelooft geen verschillende typen batterijen of accu's gebruiken en nieuwe batterijen uit accu's ook elkaar. Gebruik alleen batterijen of accu's van het aanbevolen type of van een gelijkwaardig type. Lat bij het plaatsen van de batterijen en accu's goed op de juiste polariteit. De verbruikte batterijen en accu's dienen uit het spelgoed verwijderd te worden. De aansluitingen van een batterij of van een accu mogen niet kortgesloten worden. Aanwijzingen om te bewaren.

GR 電池は充電しないで下さい。蓄電池は充電する前に玩具から取り外して下さい (玩具から取り外せるようになっている場合)。蓄電池の充電は必ず大人がいるところで行って下さい (玩具から取り外せるようになっている場合)。電池や蓄電池は、使用前、使用済、あるいは異なる種類のものなどを混ぜ合わせずおかね下さい。電池や蓄電池は、指定の種類、またはそれに類似したもの以外は使わないで下さい。電池や蓄電池をセットする時には、銘柄と極性の向きをよく確認します。使用済の電池や蓄電池は玩具から取り外して下さい。電池や蓄電池の極はショートしないよう取り扱いに注意して下さい。この説明書は保存しておいて下さい。

JPN 電池は充電しないで下さい。蓄電池は充電する前に玩具から取り外して下さい (玩具から取り外せるようになっている場合)。蓄電池の充電は必ず大人がいるところで行って下さい (玩具から取り外せるようになっている場合)。電池や蓄電池は、使用前、使用済、あるいは異なる種類のものなどを混ぜ合わせずおかね下さい。電池や蓄電池は、指定の種類、またはそれに類似したもの以外使わないで下さい。電池や蓄電池をセットする時には、銘柄と極性の向きをよく確認します。使用済の電池や蓄電池は玩具から取り外して下さい。電池や蓄電池の極はショートしないよう取り扱いに注意して下さい。この説明書は保存しておいて下さい。

USA Do not mix old and new batteries. Do not mix alkaline, standard (carbon-zinc), or rechargeable (nickel-cadmium) batteries.

Made in France by / Fabriqué en France par / Fabricado en Francia por :



363, avenue de Saint Exupéry
62100 Calais - France
<http://www.meccano.com>

© 05/2003 MECCANO S.N.

® MECCANO and ERECTOR are exclusive trademarks of MECCANO S.N.
All rights reserved