

4

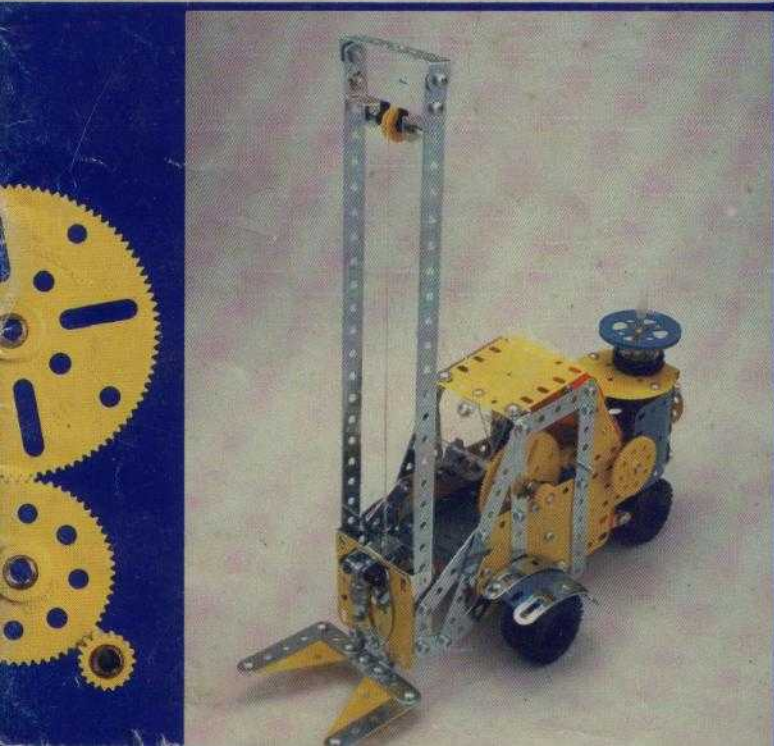

MECCANO

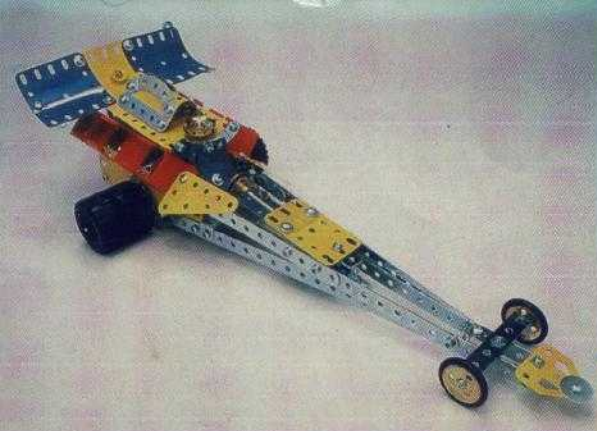



Suggestions for models to build yourself.



Propositions de modèles pour constructions personnelles.



Vorschläge für Modelle zum Selberbauen.



Ideën voor zelfbouw-modellen.



Proposte di modelli per costruzioni personali.



Propuestas de modelos para construcciones personales.

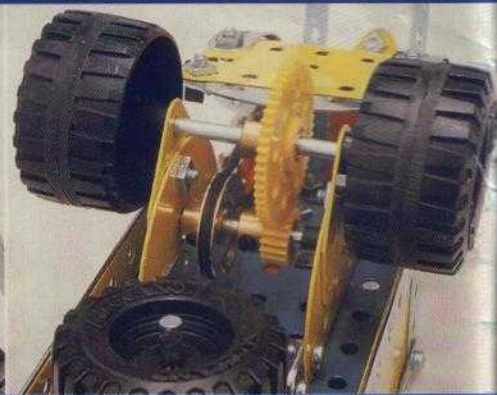
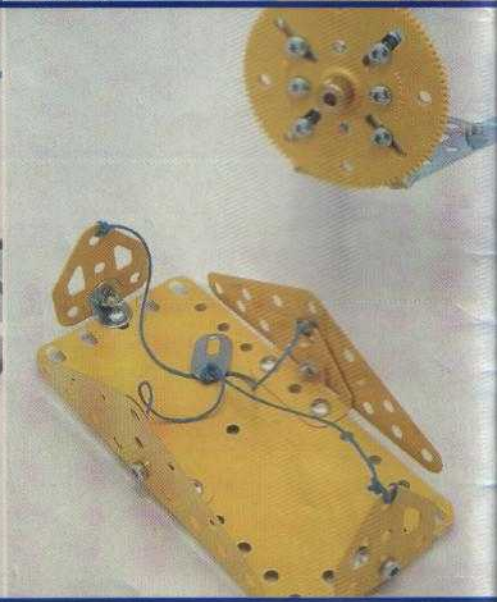
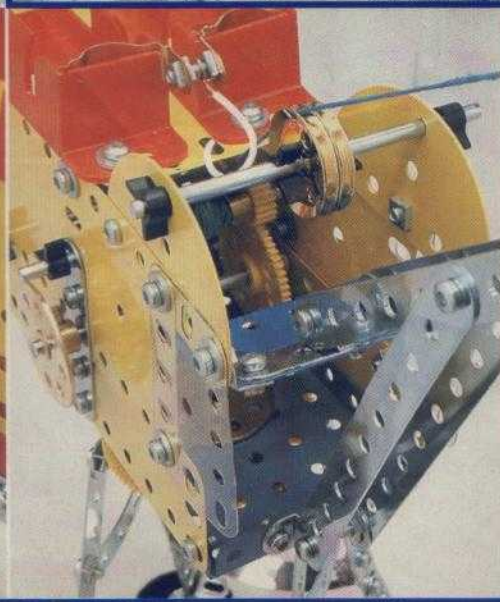
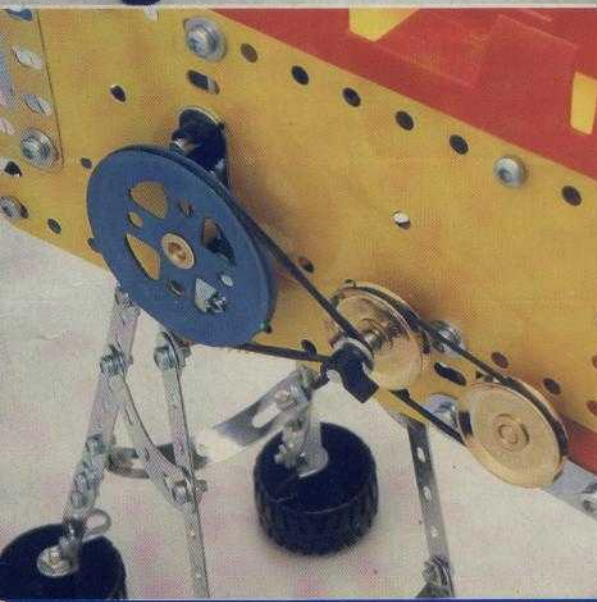
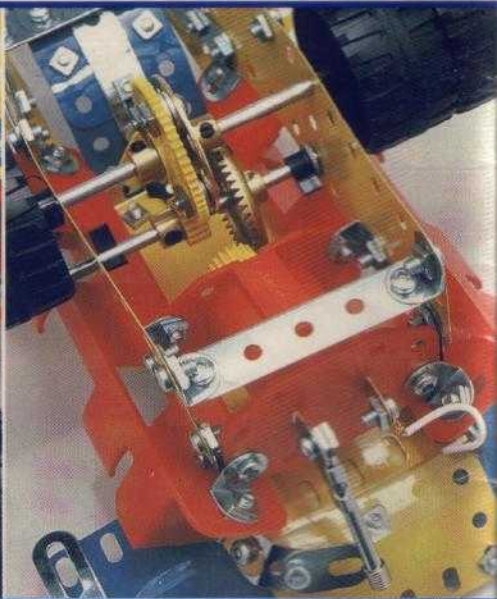
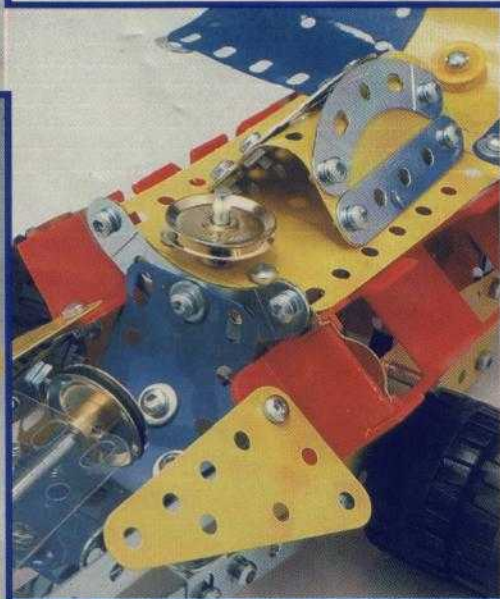
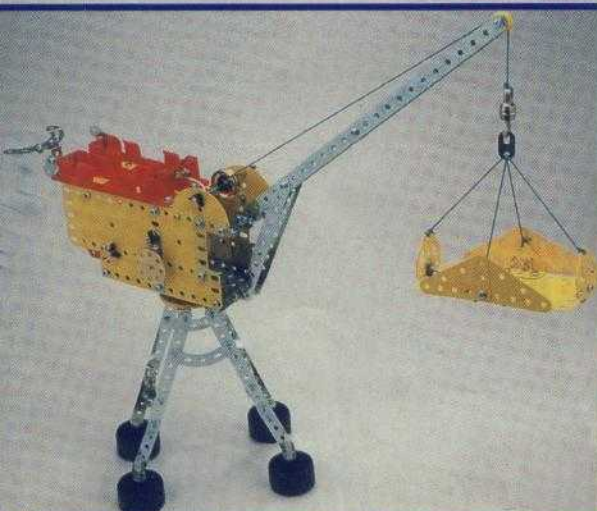

Fitting the electric motor: see instruction book 2 page 3.



Montages électriques: voir notice 2 page 3.



Elektrische Montage: Siehe Notiz 2 Seite 3.



Elektrische aansluitingen: zie lijst 2 blz. 3.



Montaggi elettrici: vedere manuale d'istruzioni 2 pagina 3.



Montajes eléctricos: vease folleto 2, pagina 3.

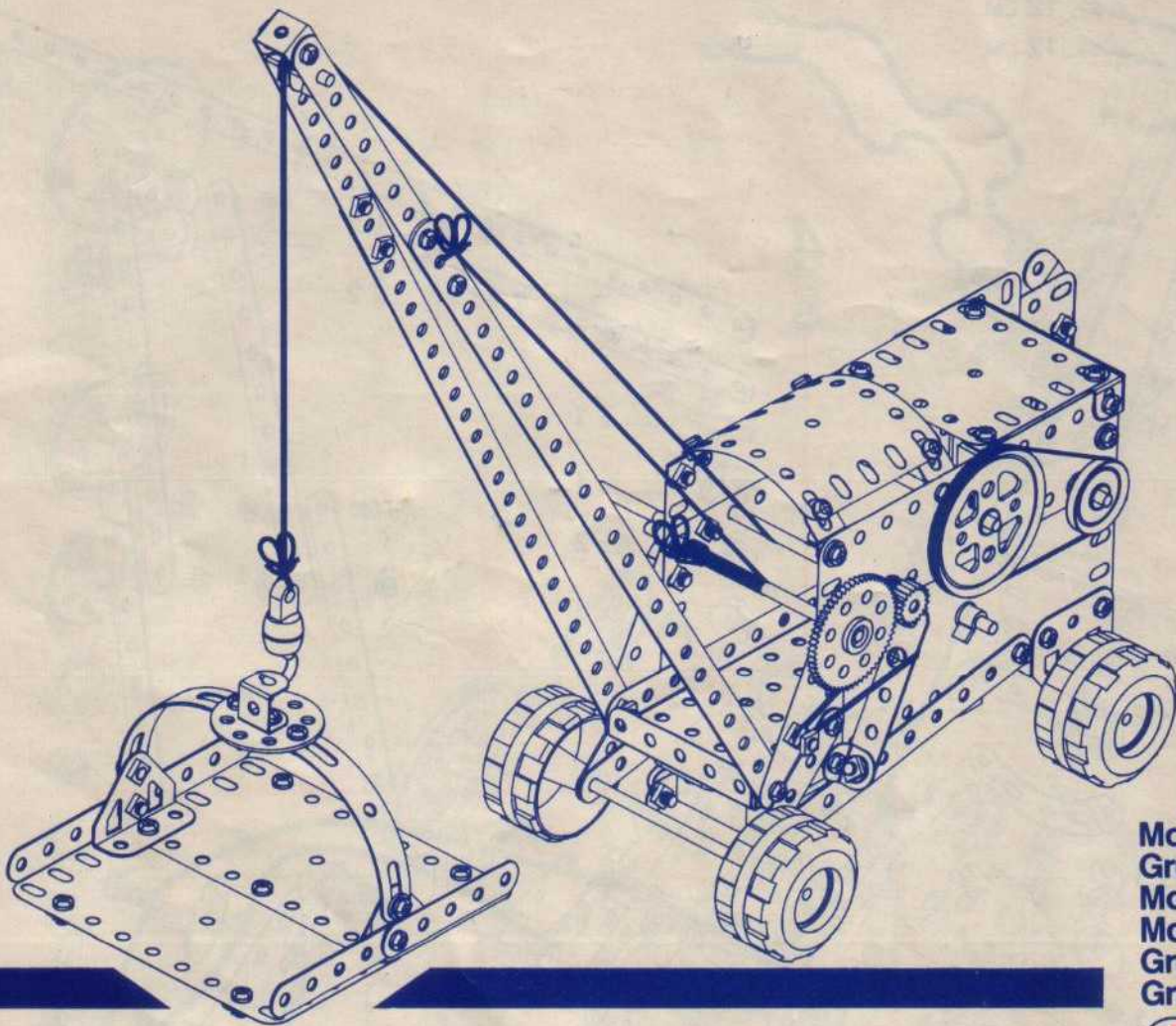

Mobile Crane
Grue mobile
Mobiler Kran
Mobiele hijskraan
Gru mobile
Grúa movíl

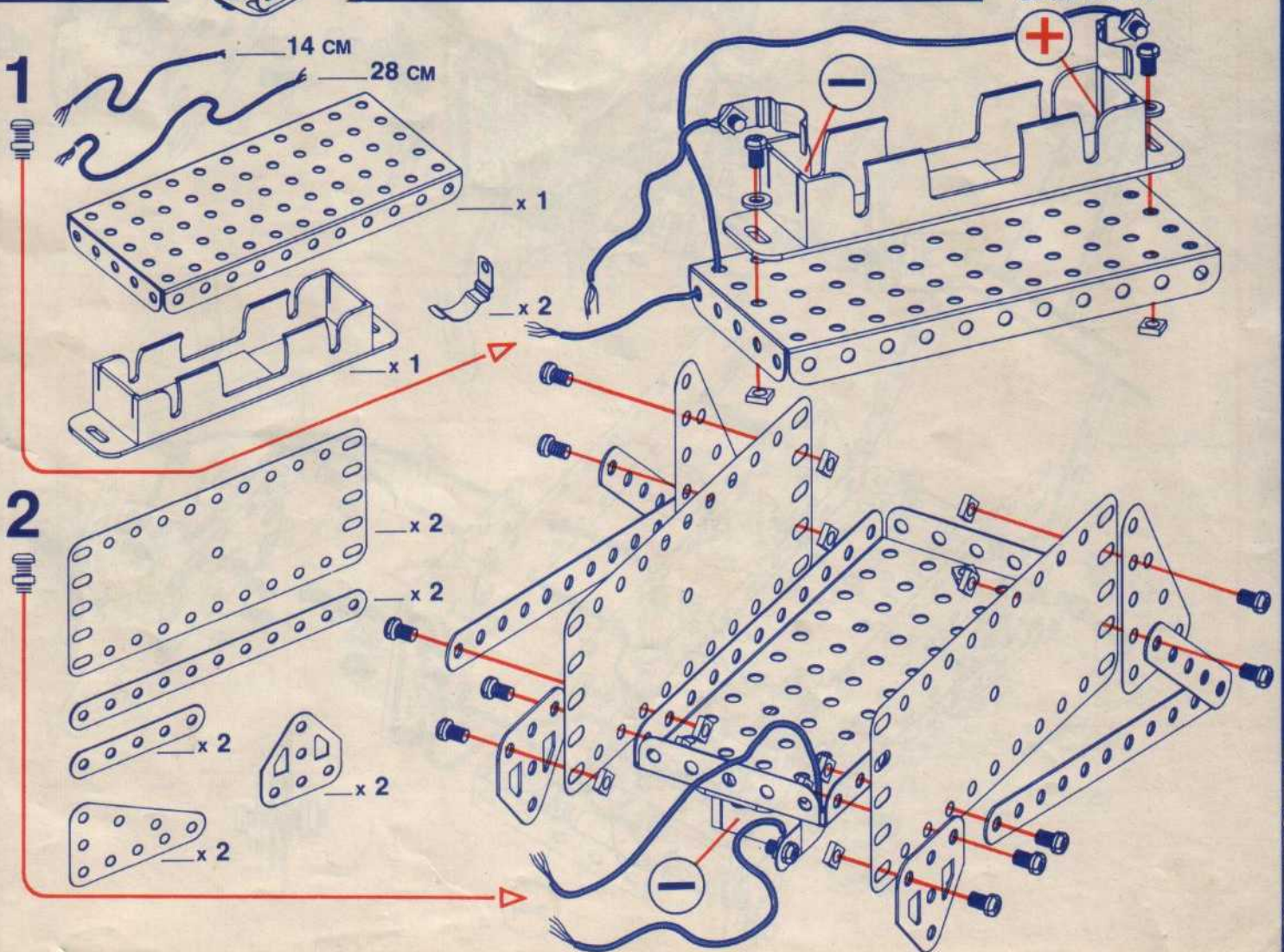

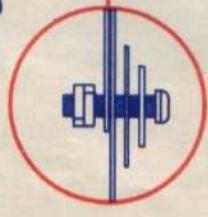
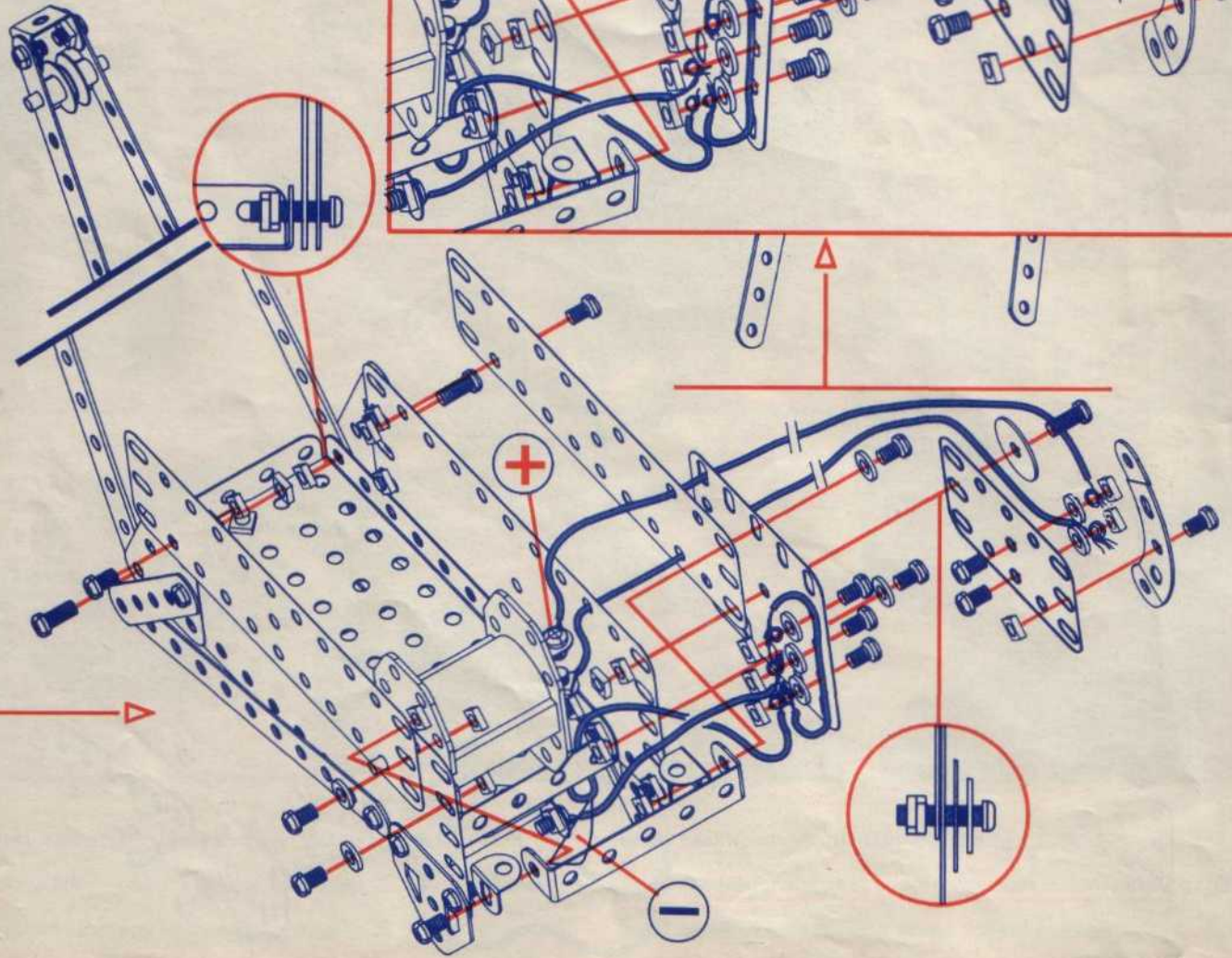
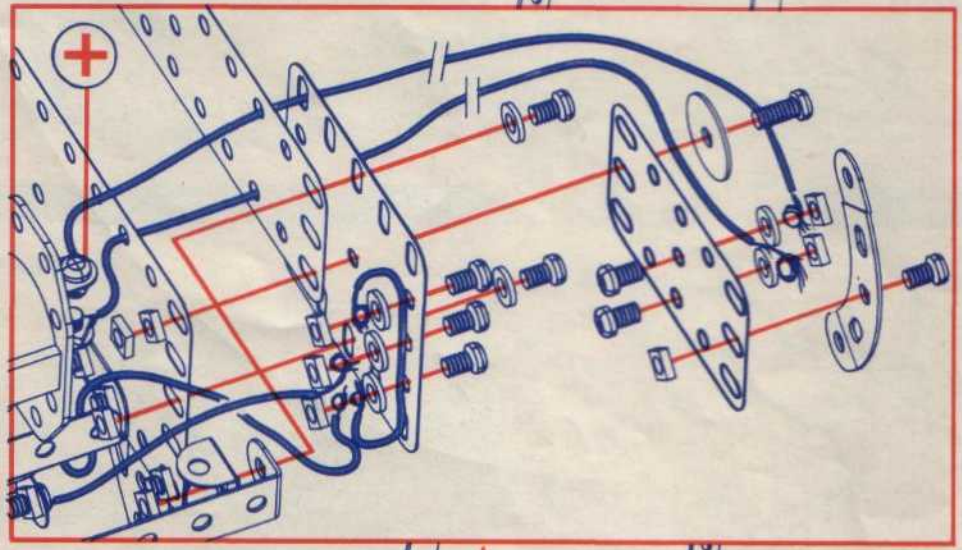
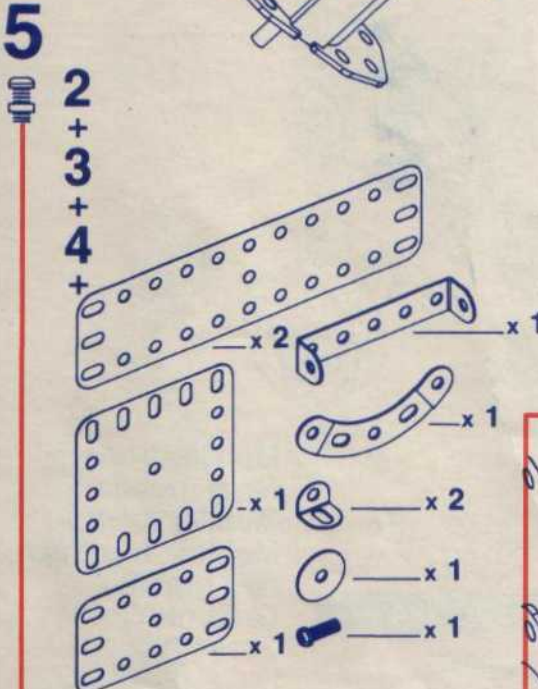
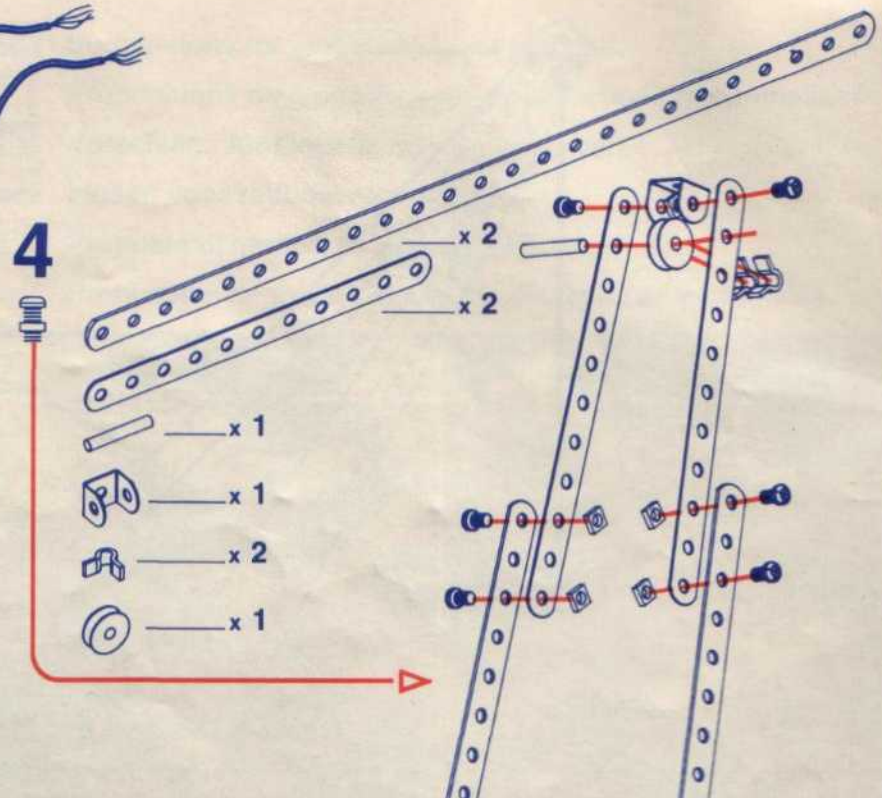
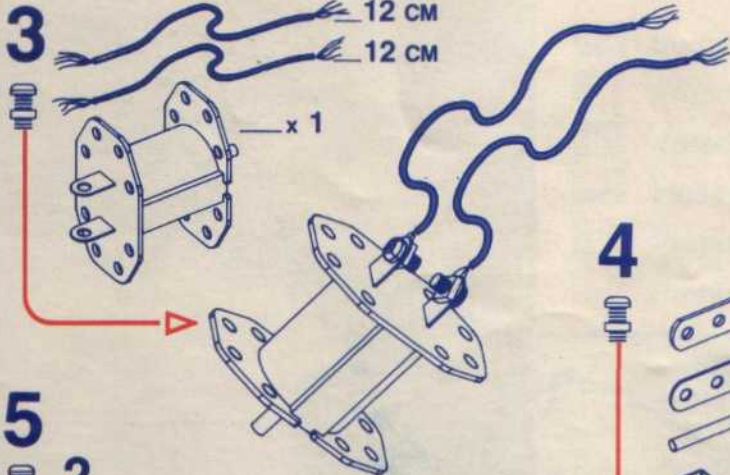



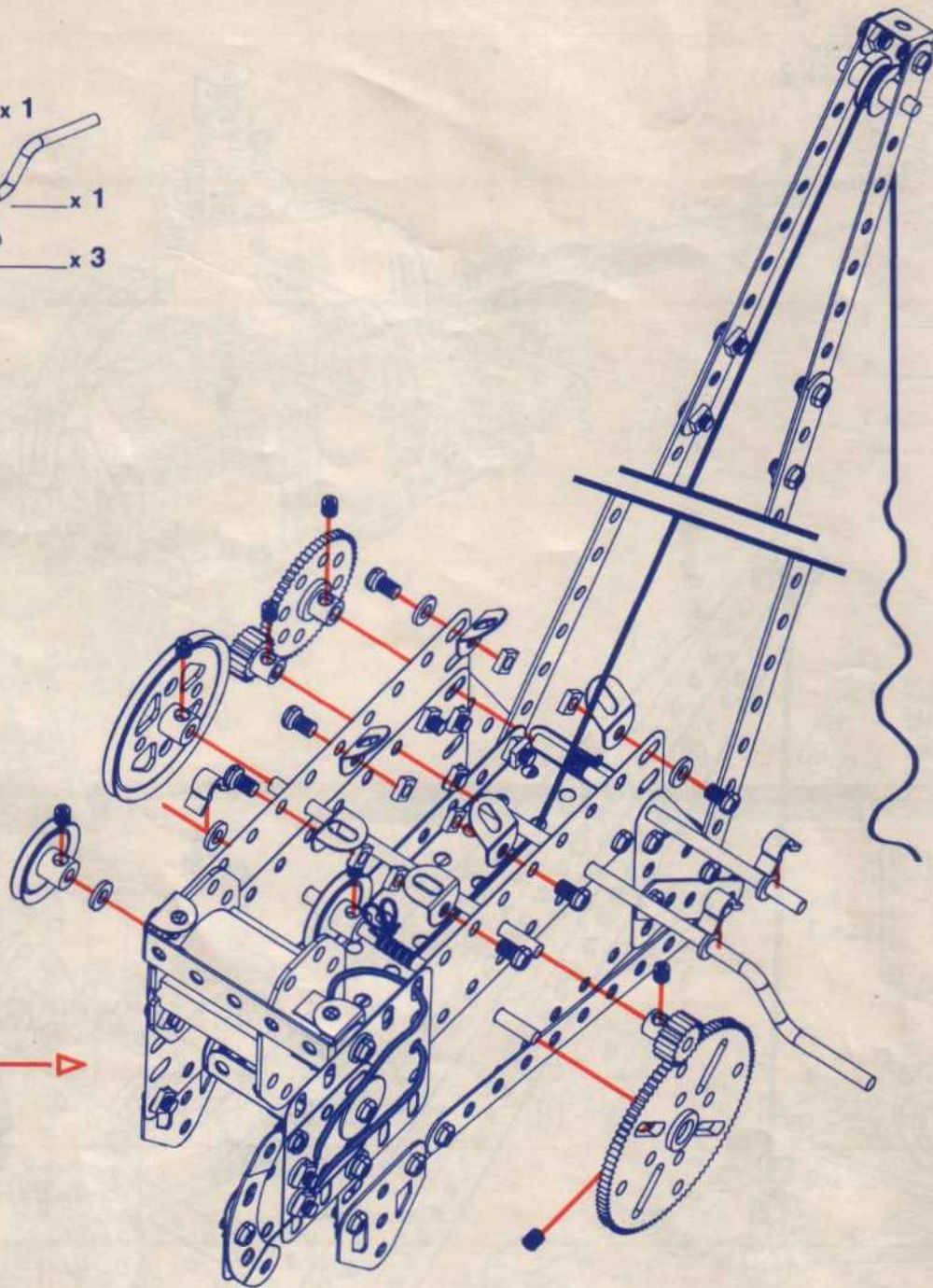
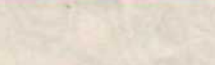
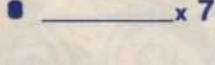
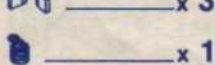
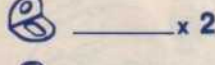
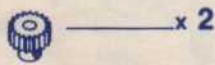
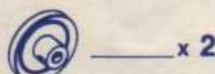
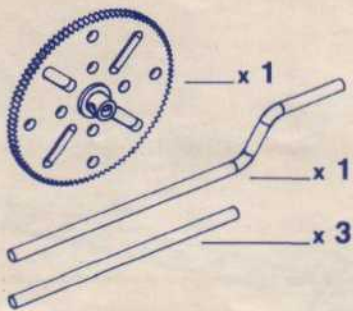

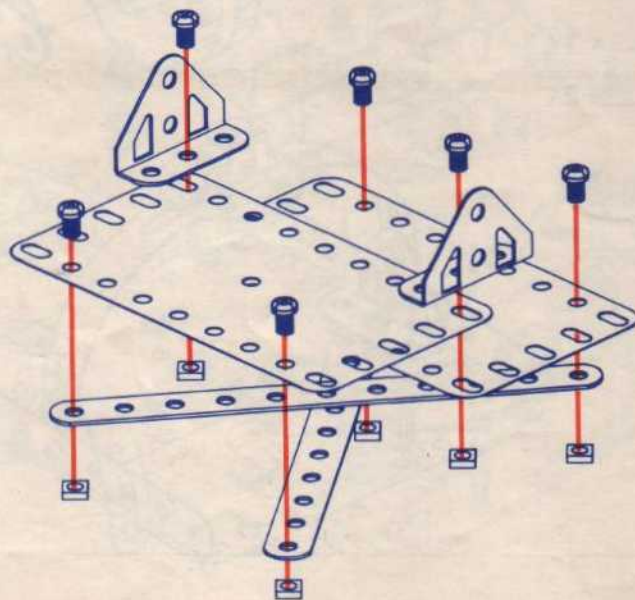
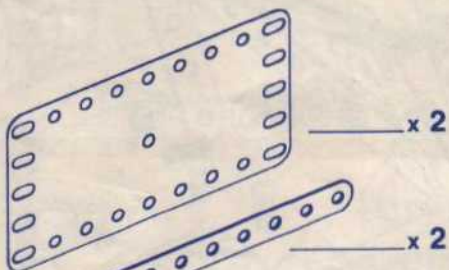

6



7

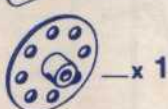





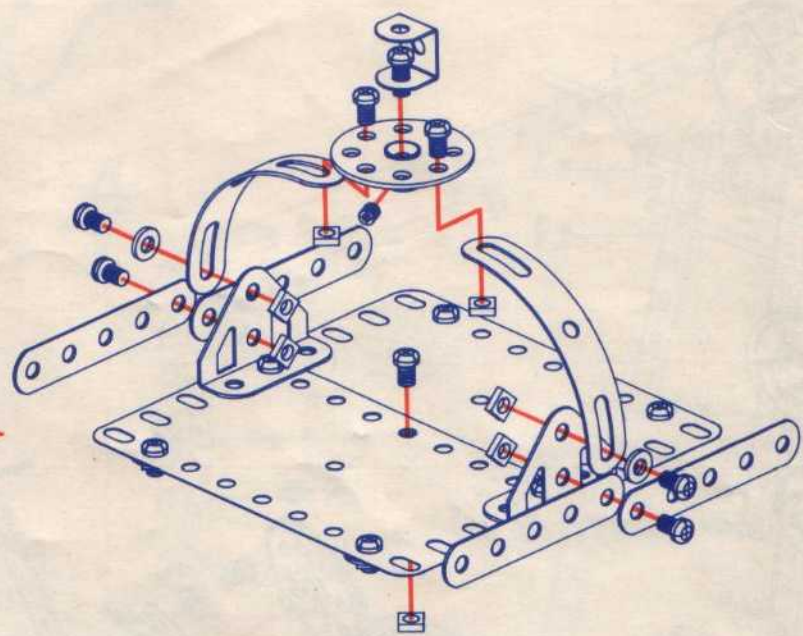

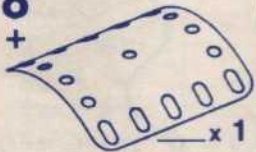
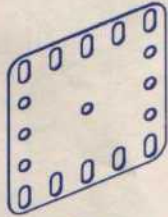

8

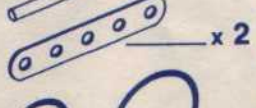
-  x 2
-  x 4
-  x 1
-  x 1
-  x 1
-  x 1



9

- +  x 1
-  x 1
-  x 4
-  x 2
-  x 2
-  x 1
-  x 1
-  x 1
-  x 2
-  x 1

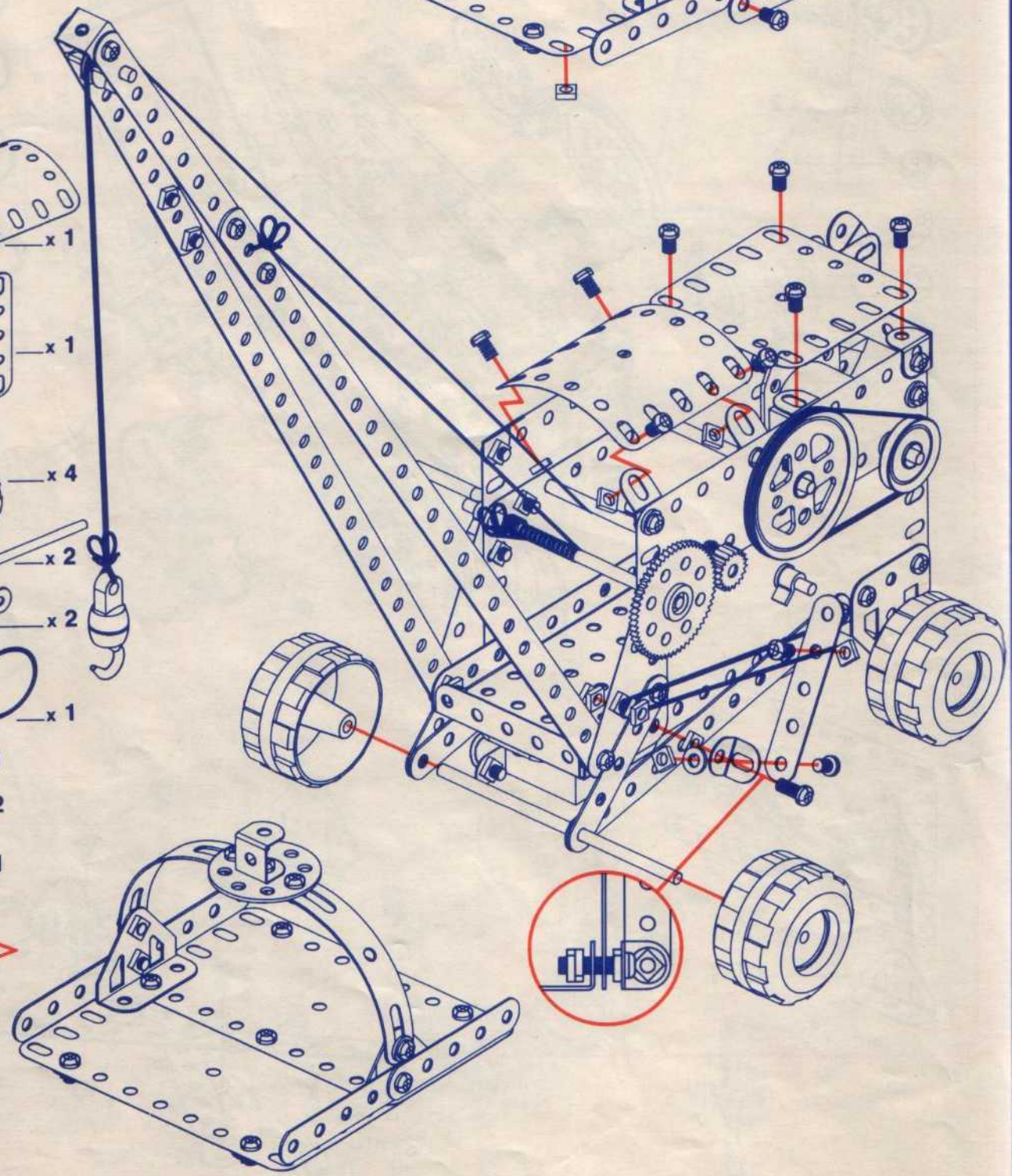

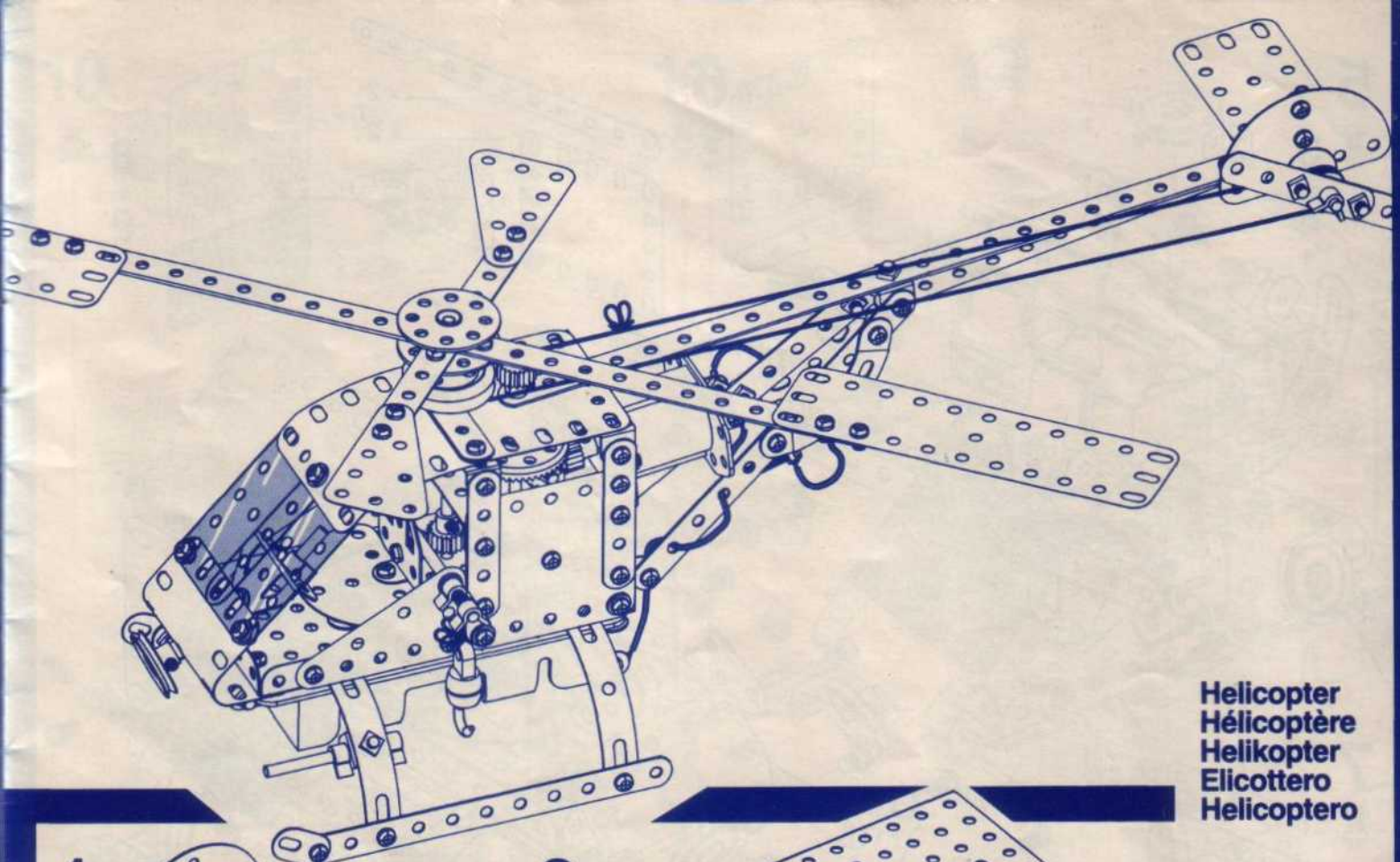

Helicopter
 Hélicoptère
 Helikopter
 Elicottero
 Helicoptero

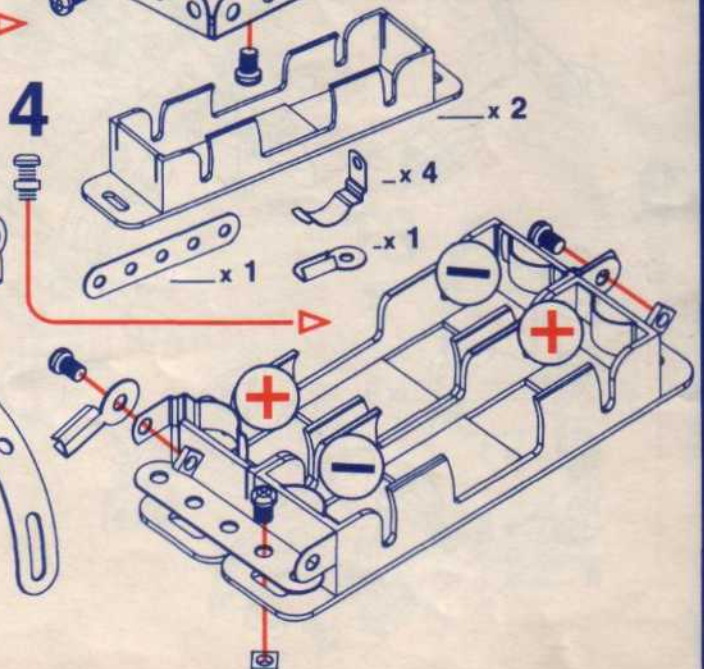
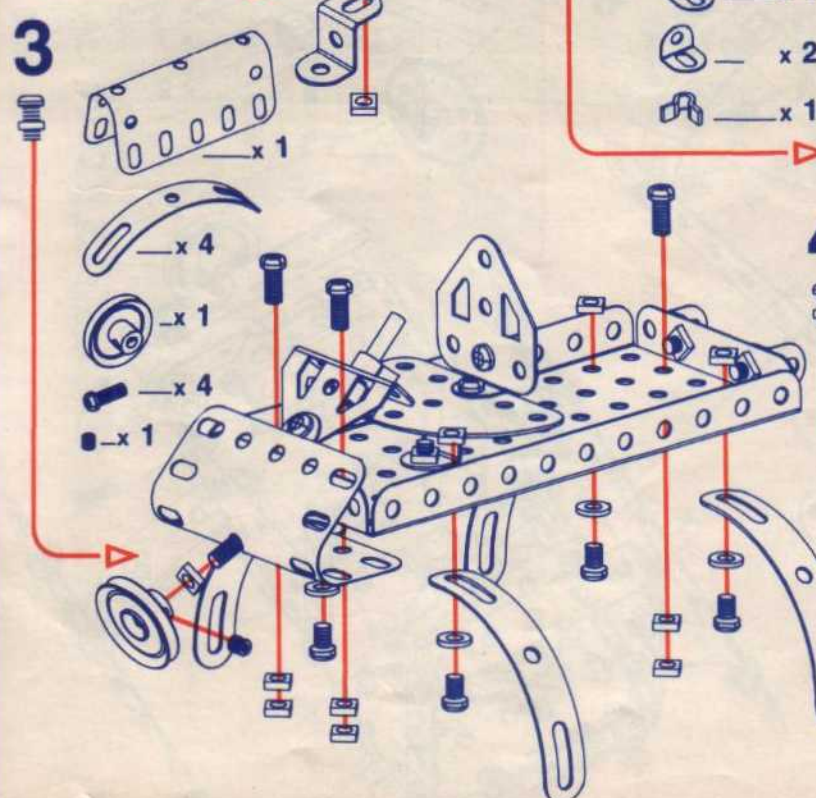
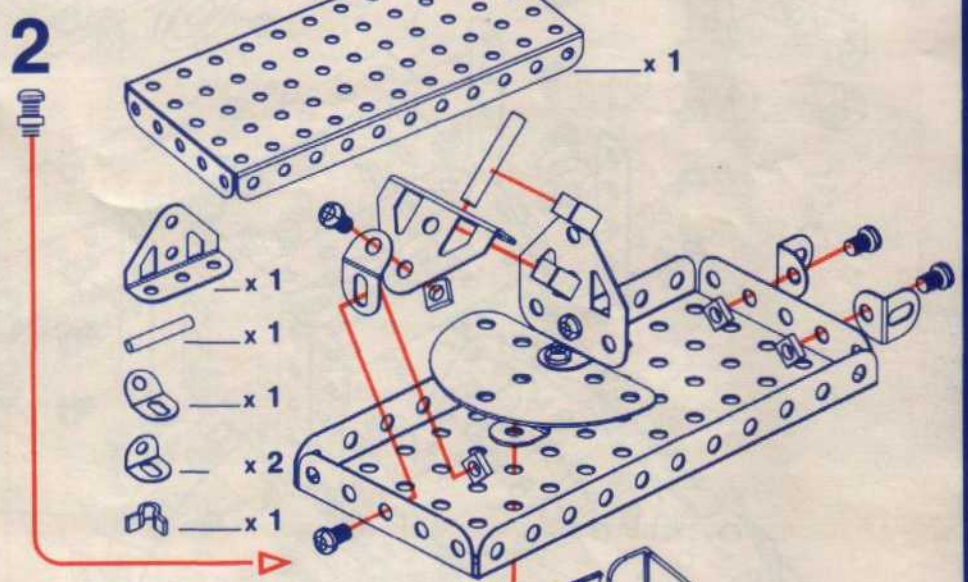
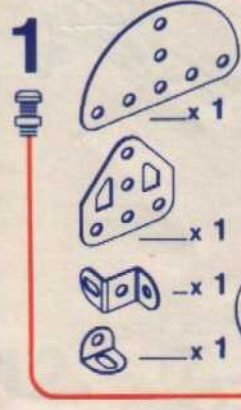

5

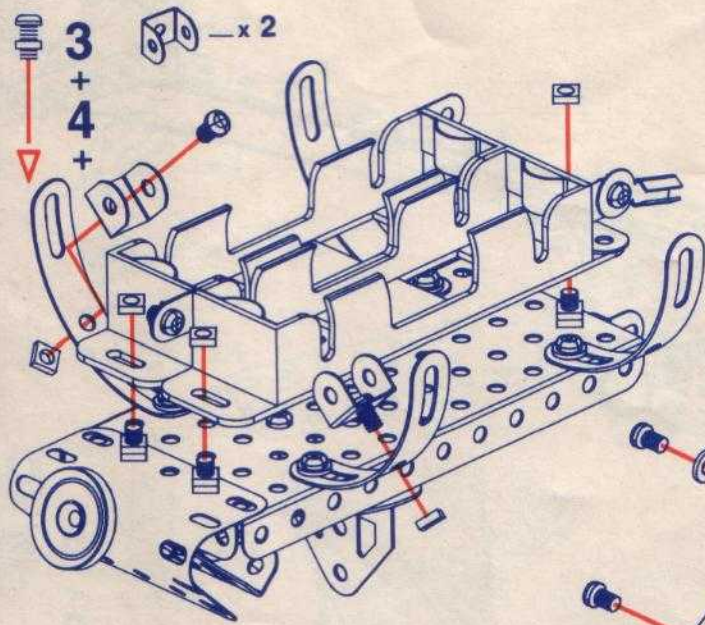

6

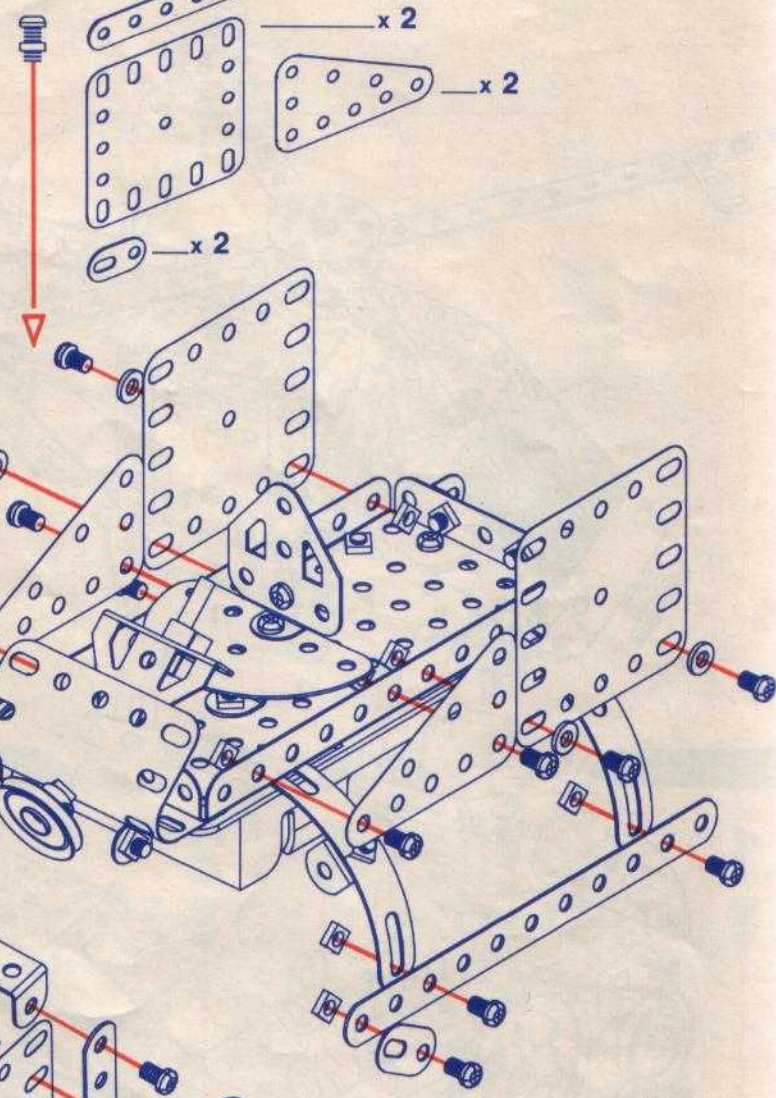

7

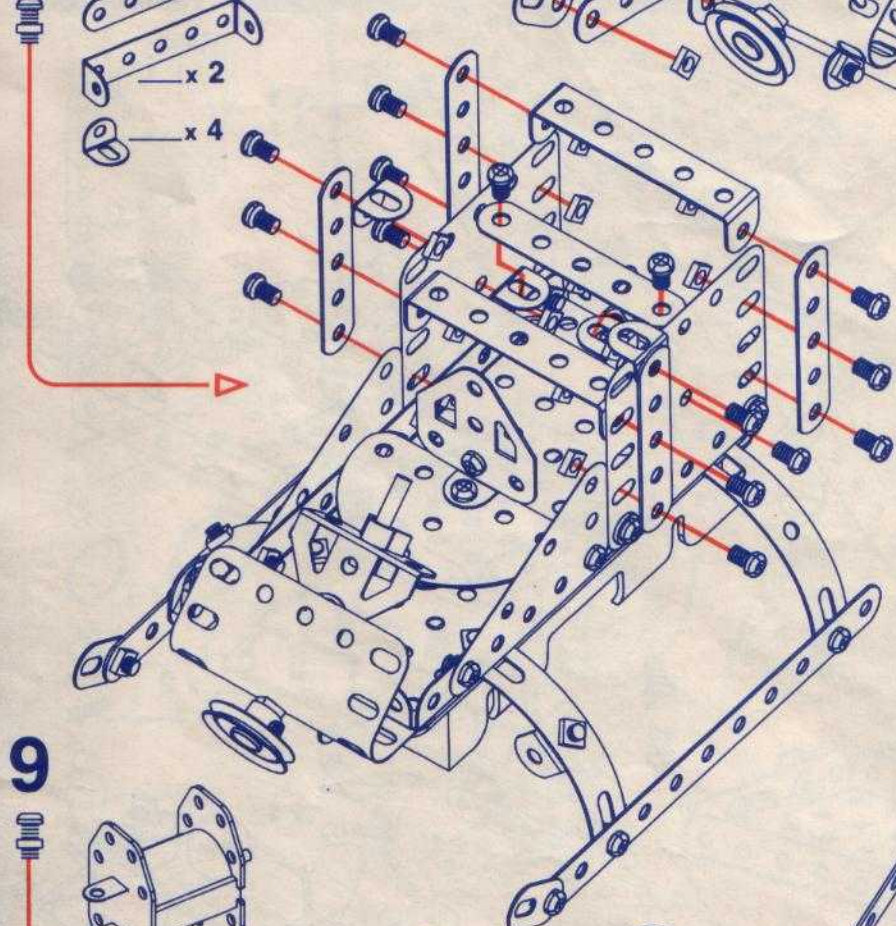

8

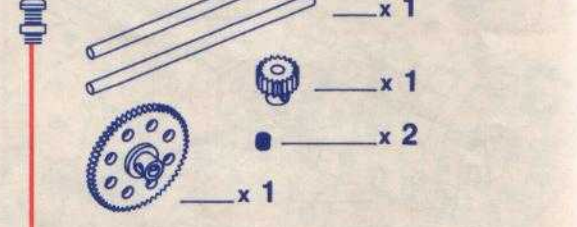

9

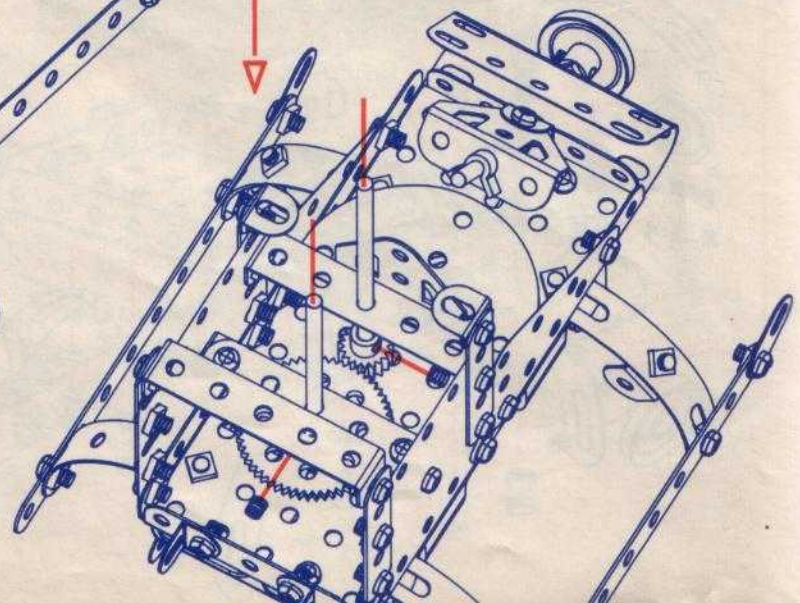
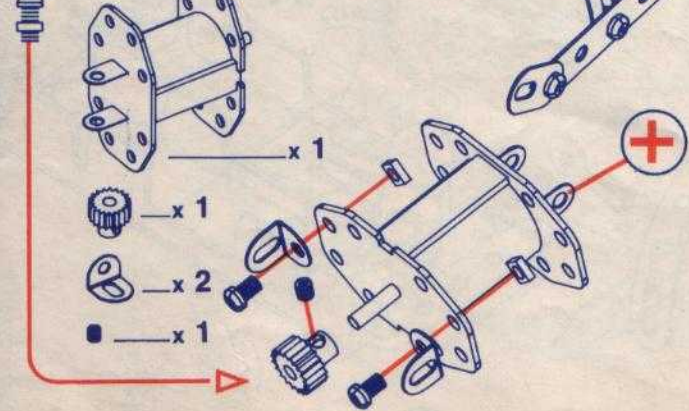

10

8 + 9 +

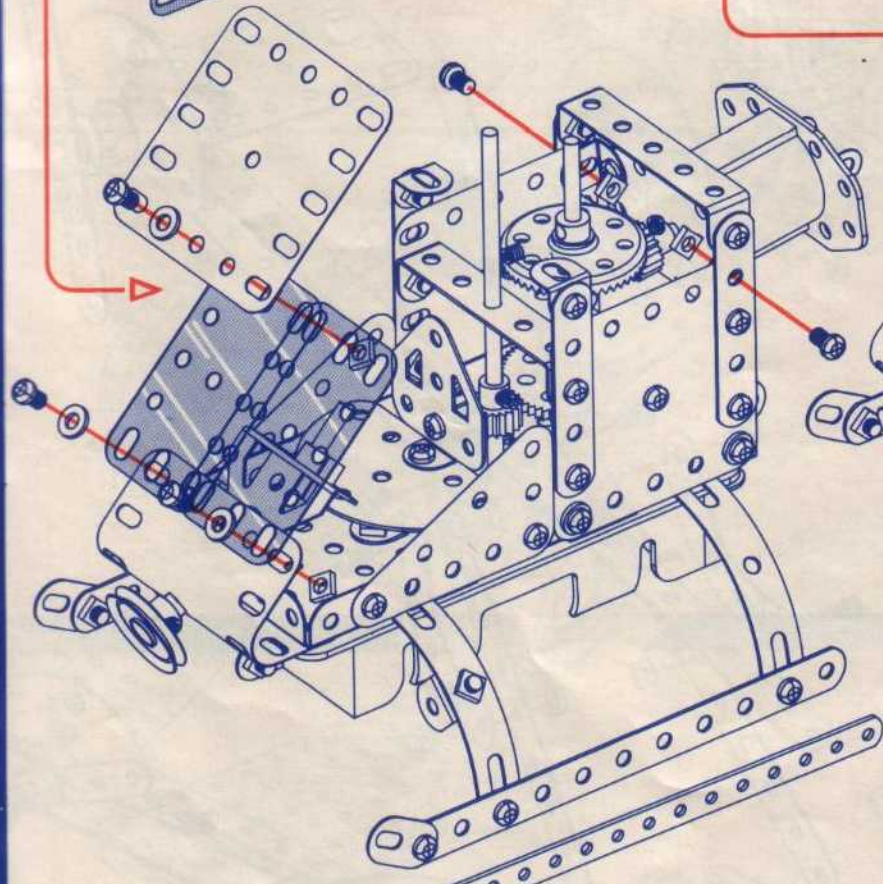
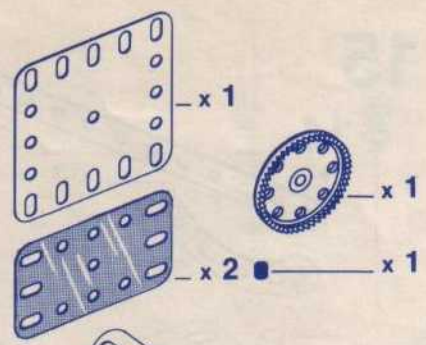

11

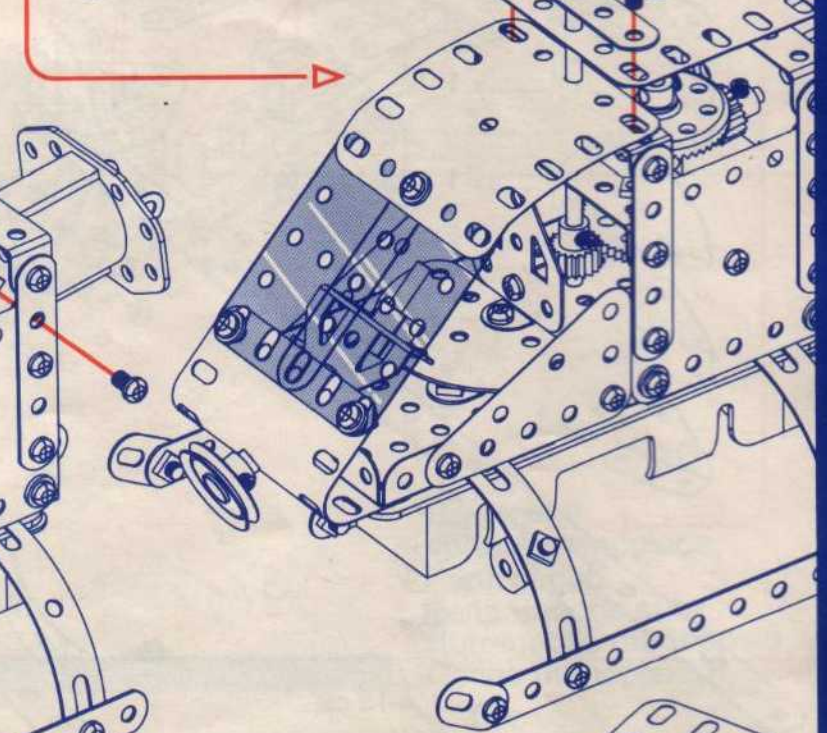
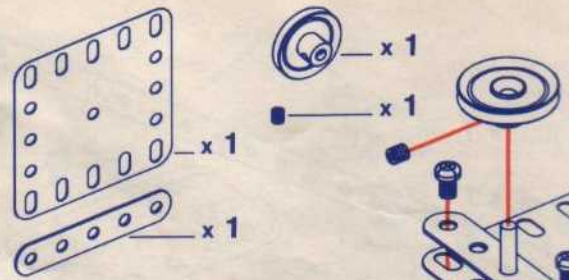

12

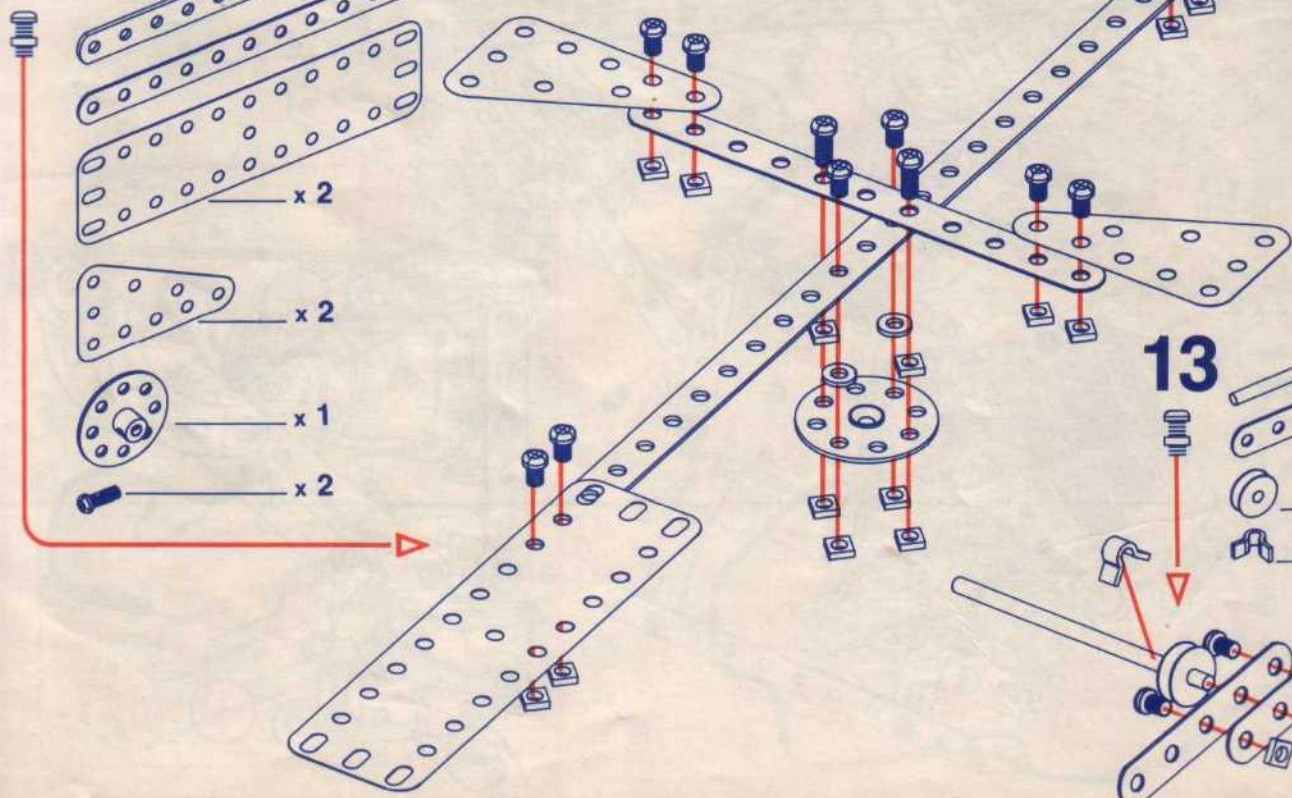
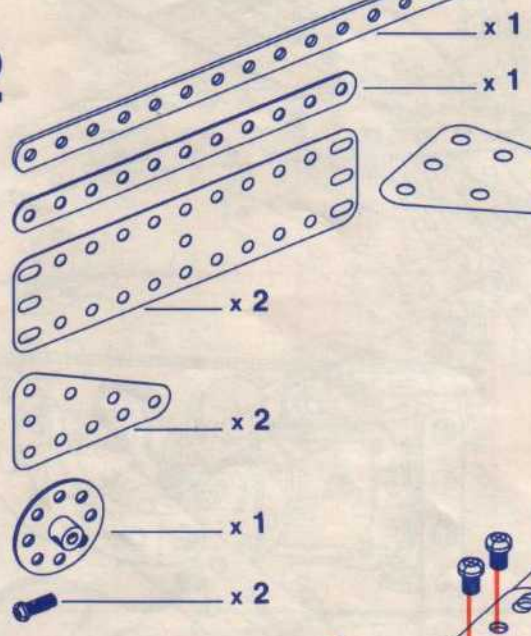

13

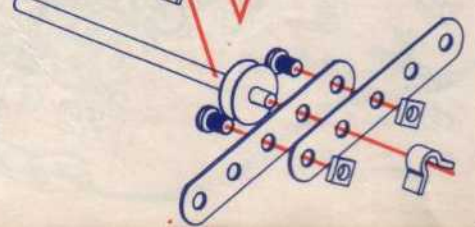
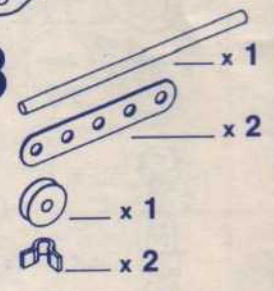

14

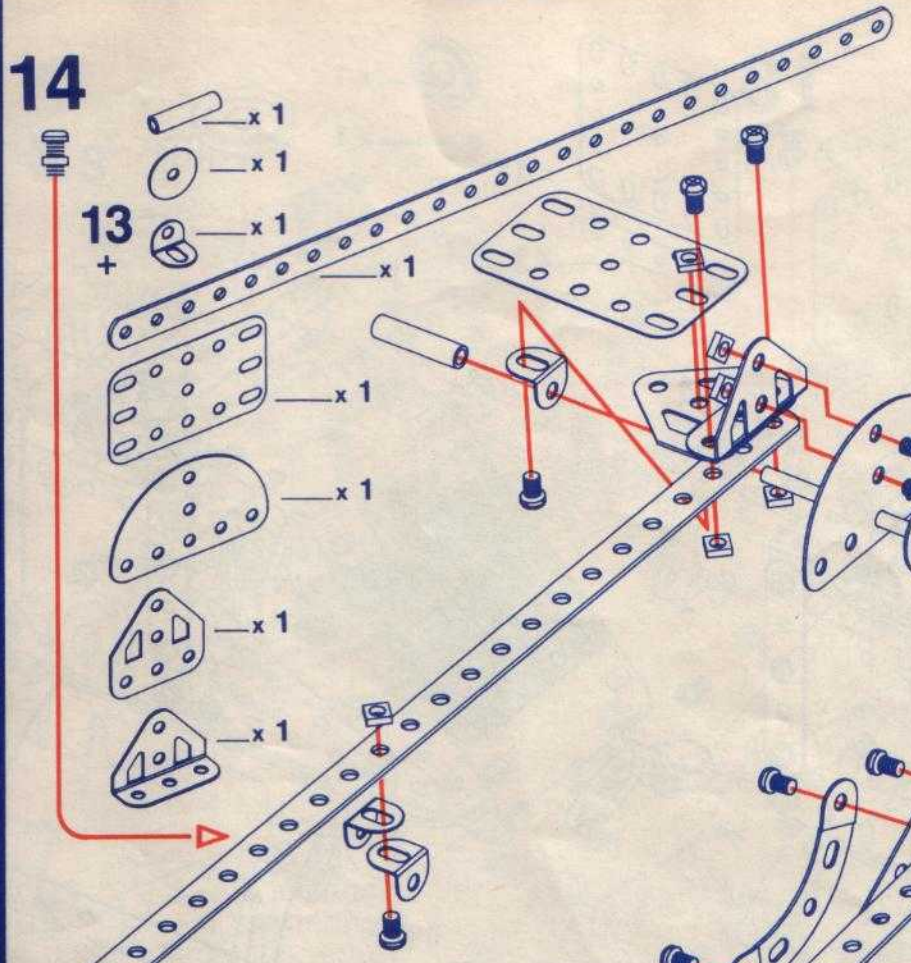

15

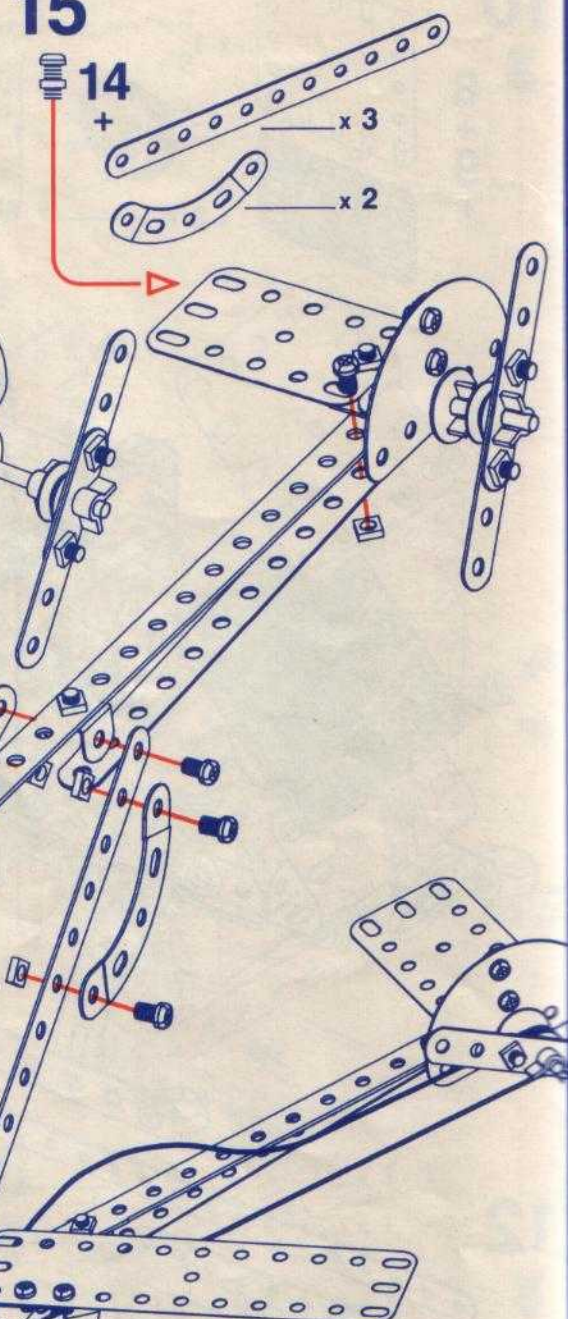

16

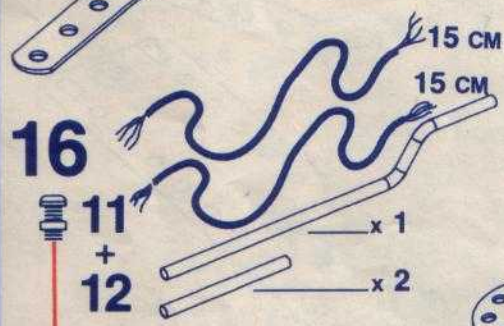

- + 15
- + x 1
- x 2
- x 2
- x 1
- x 1
- x 1
- x 6
- x 2

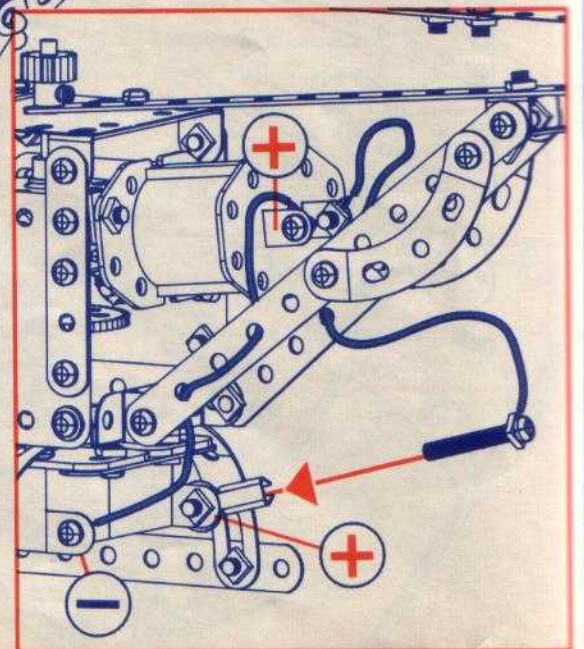

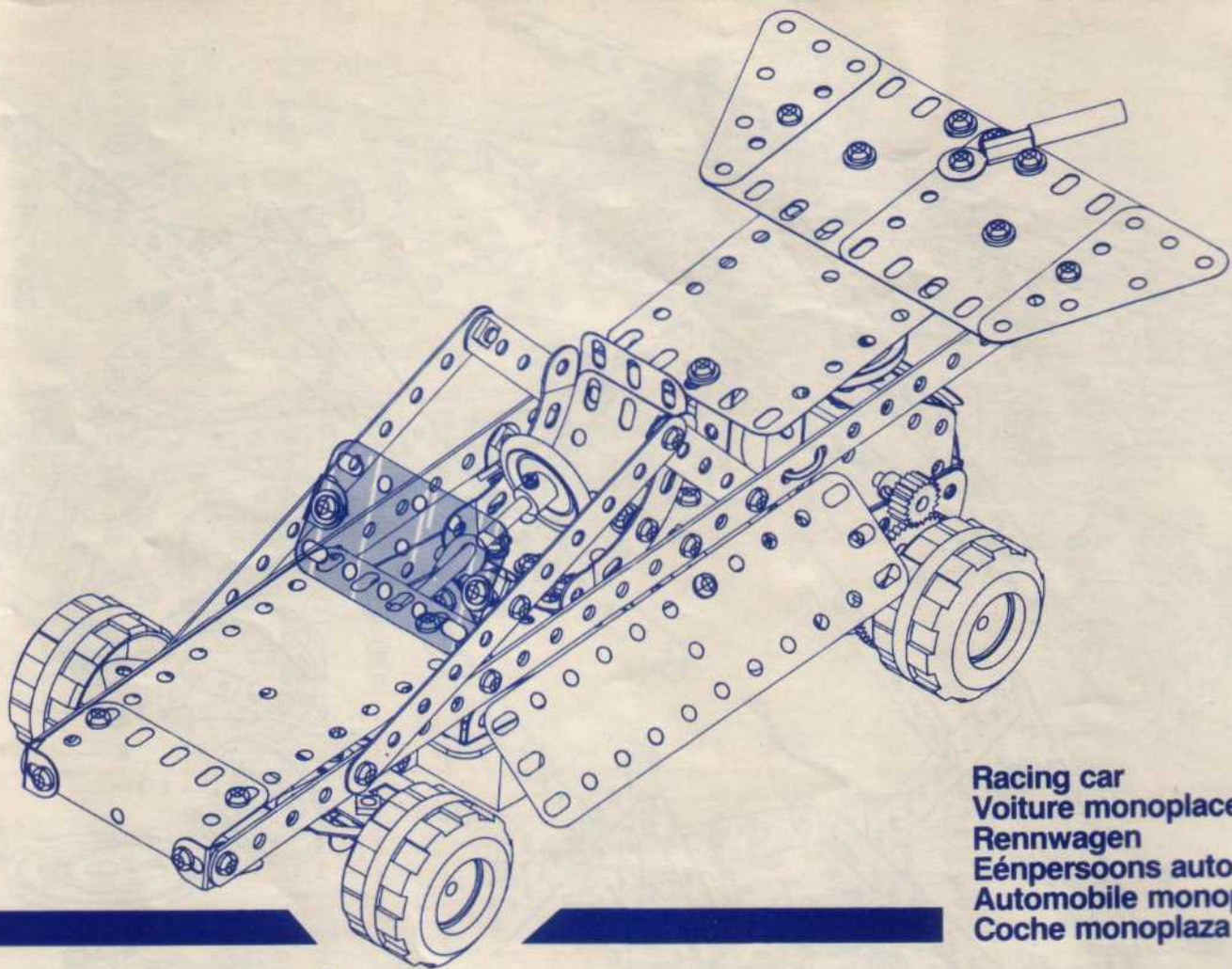

Racing car
Voiture monoplace
Rennwagen
Éénpersoons auto
Automobile monoposto
Coche monoplaza

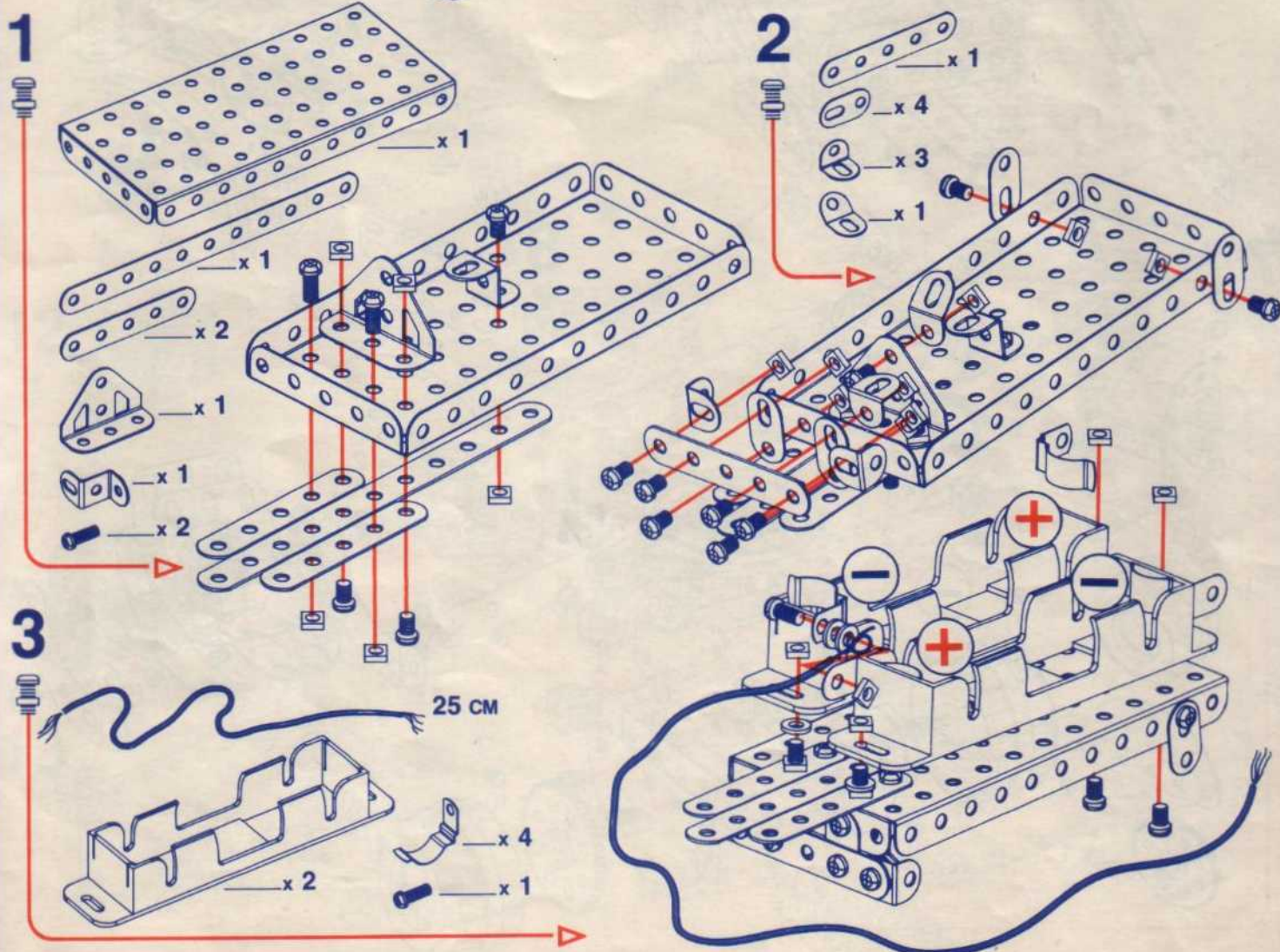

4

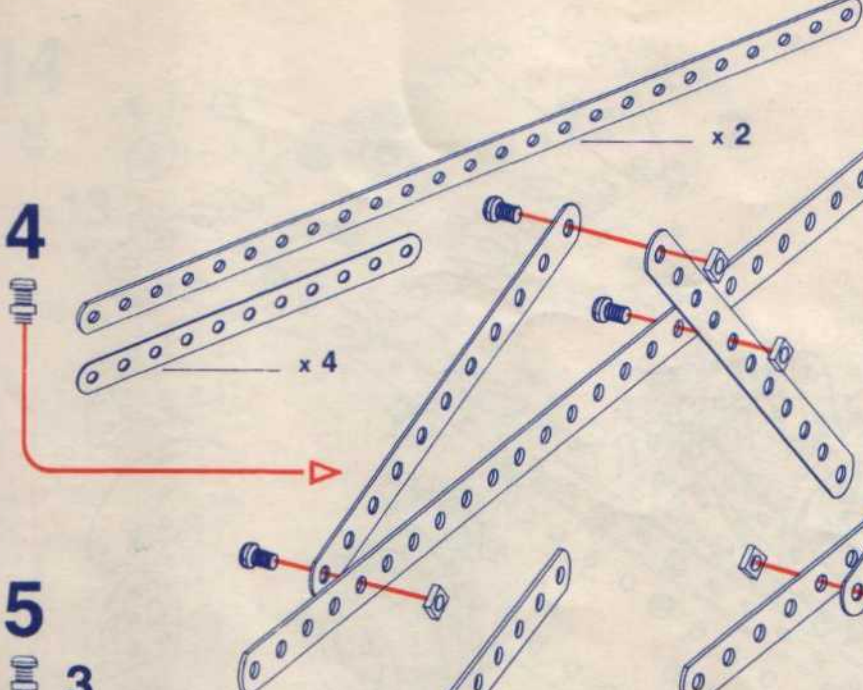

5

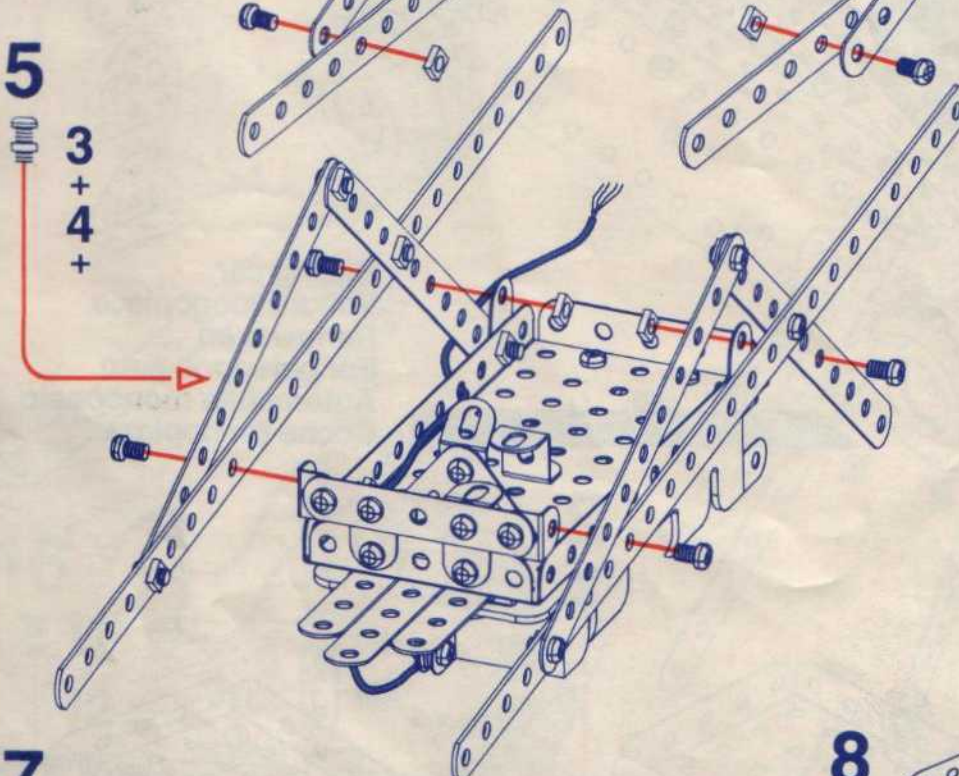

6

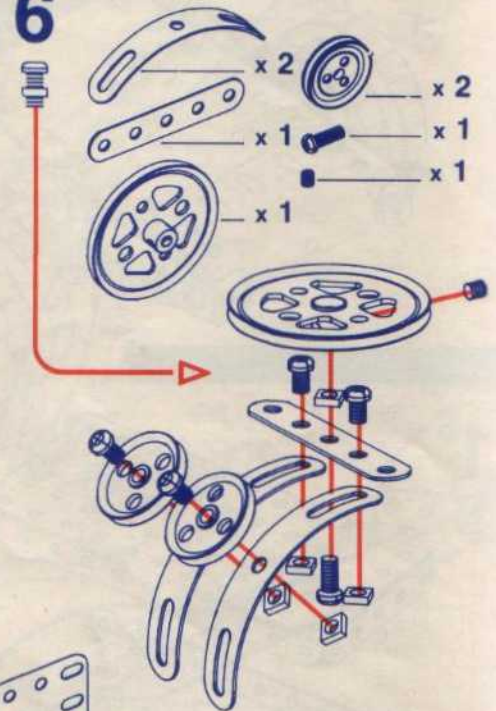

7

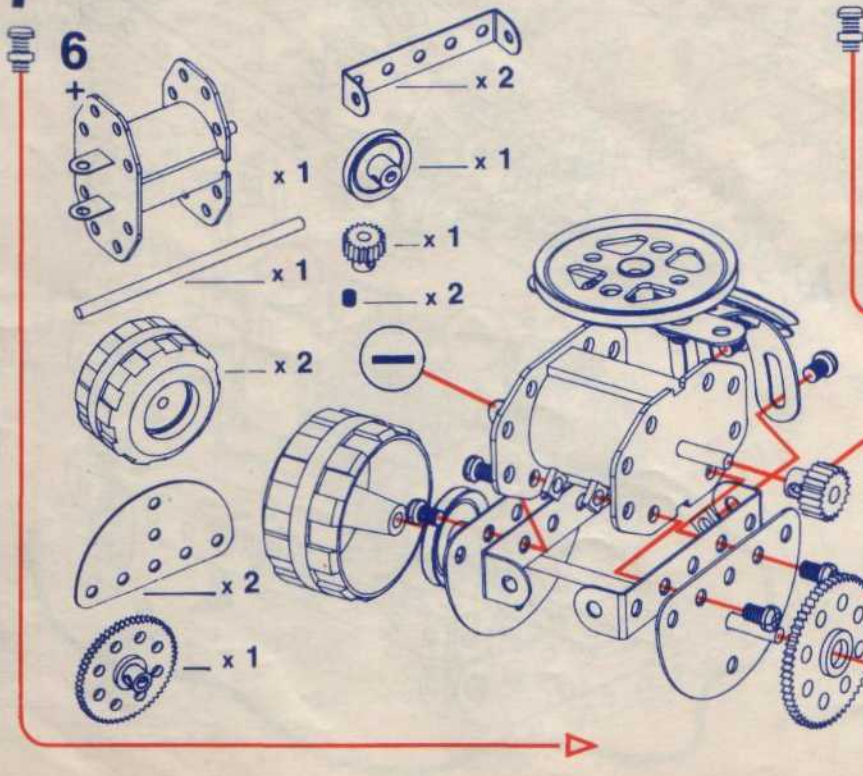

8

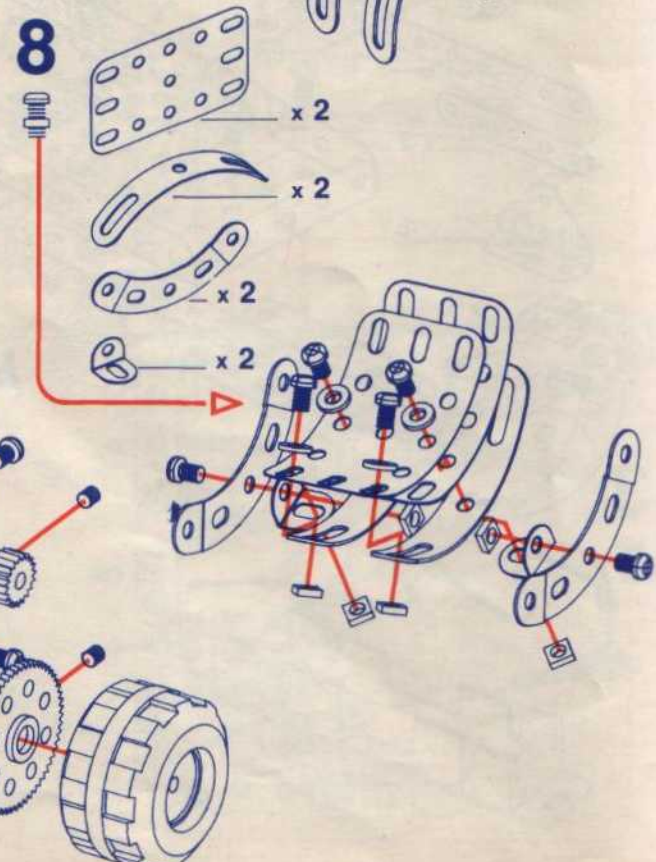

9

5
+
7
+
8
+

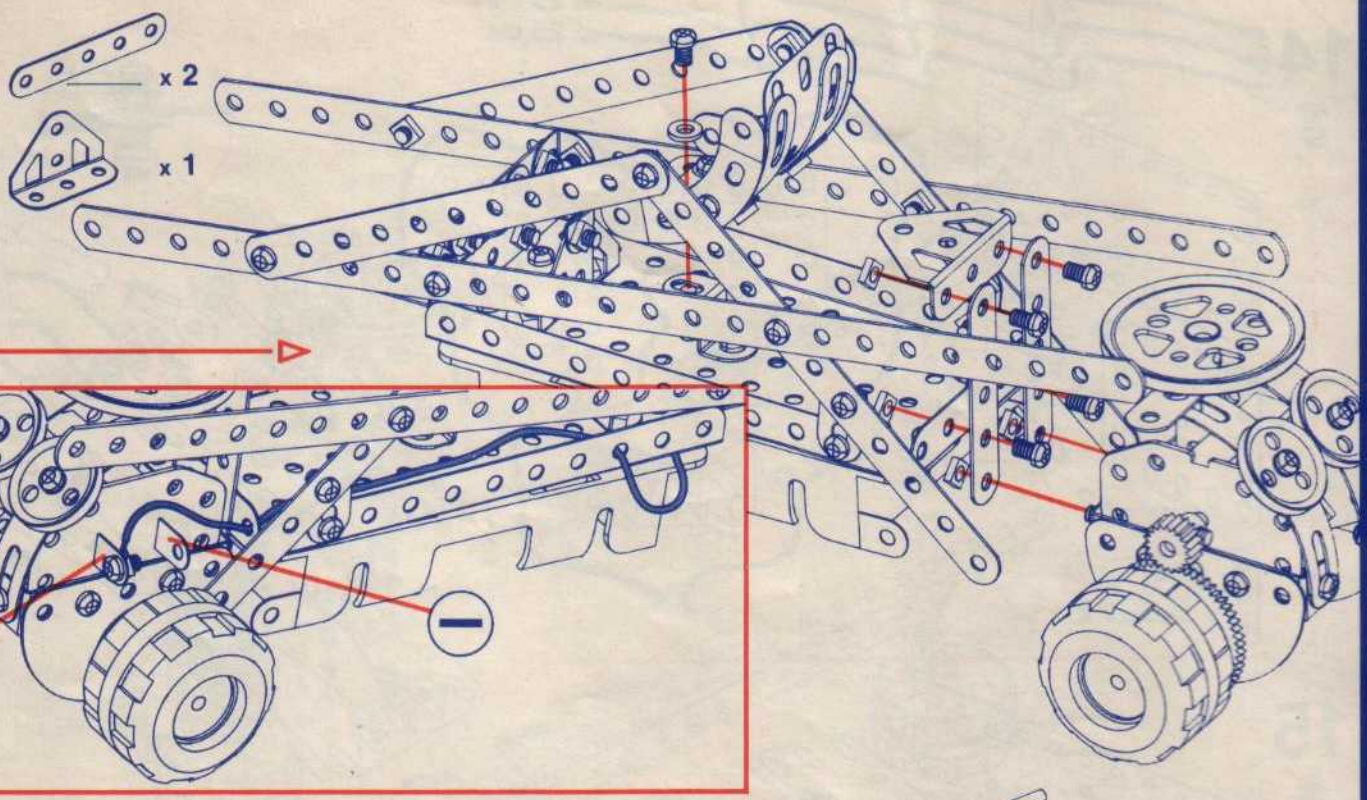

10

9
+
10
+

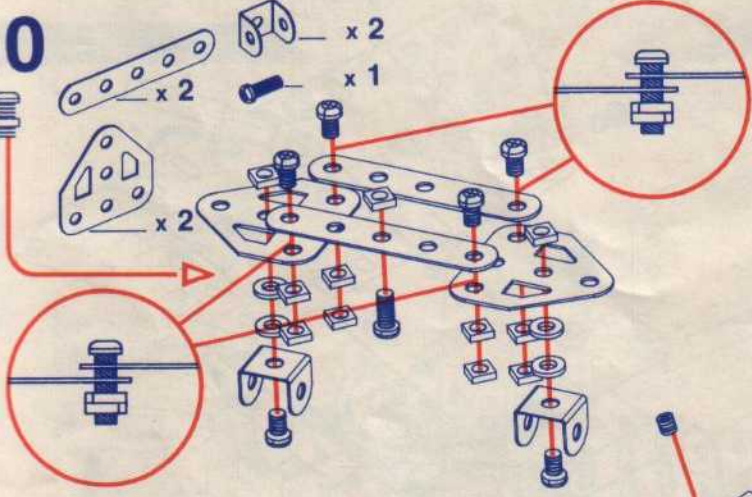

11

9
+
10
+

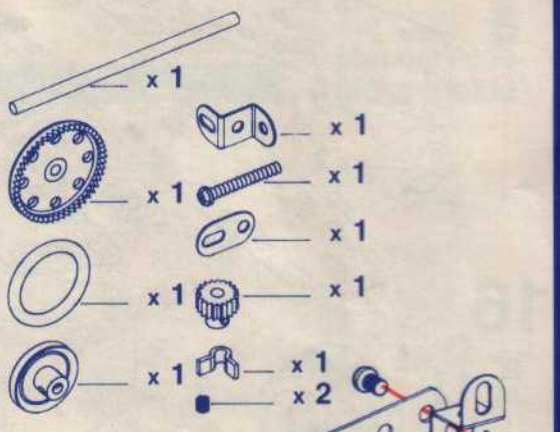

12

9
+
10
+

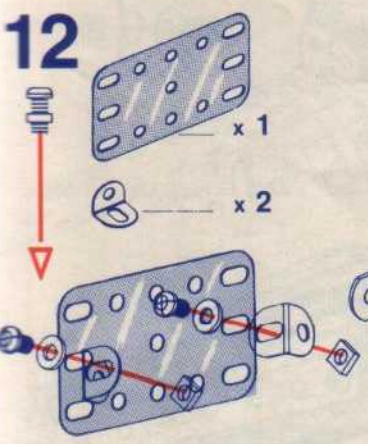

13

9
+
10
+

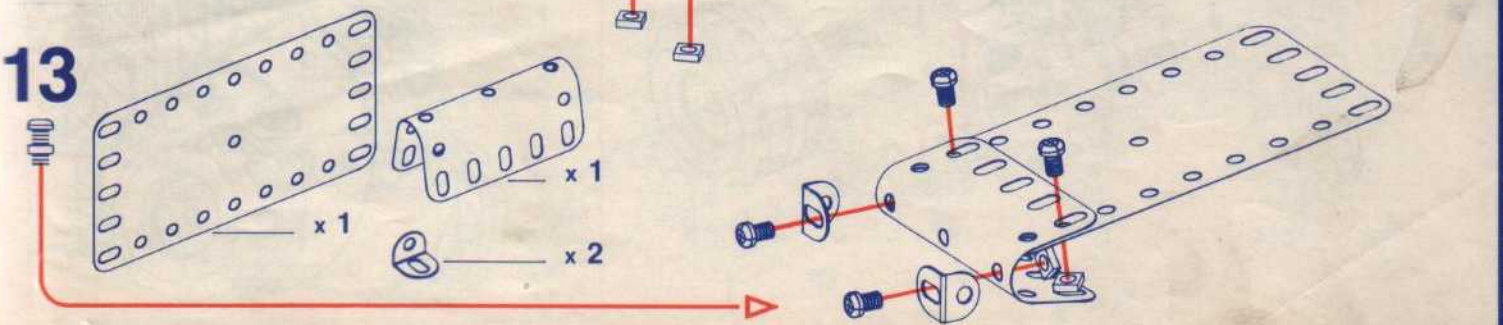

14

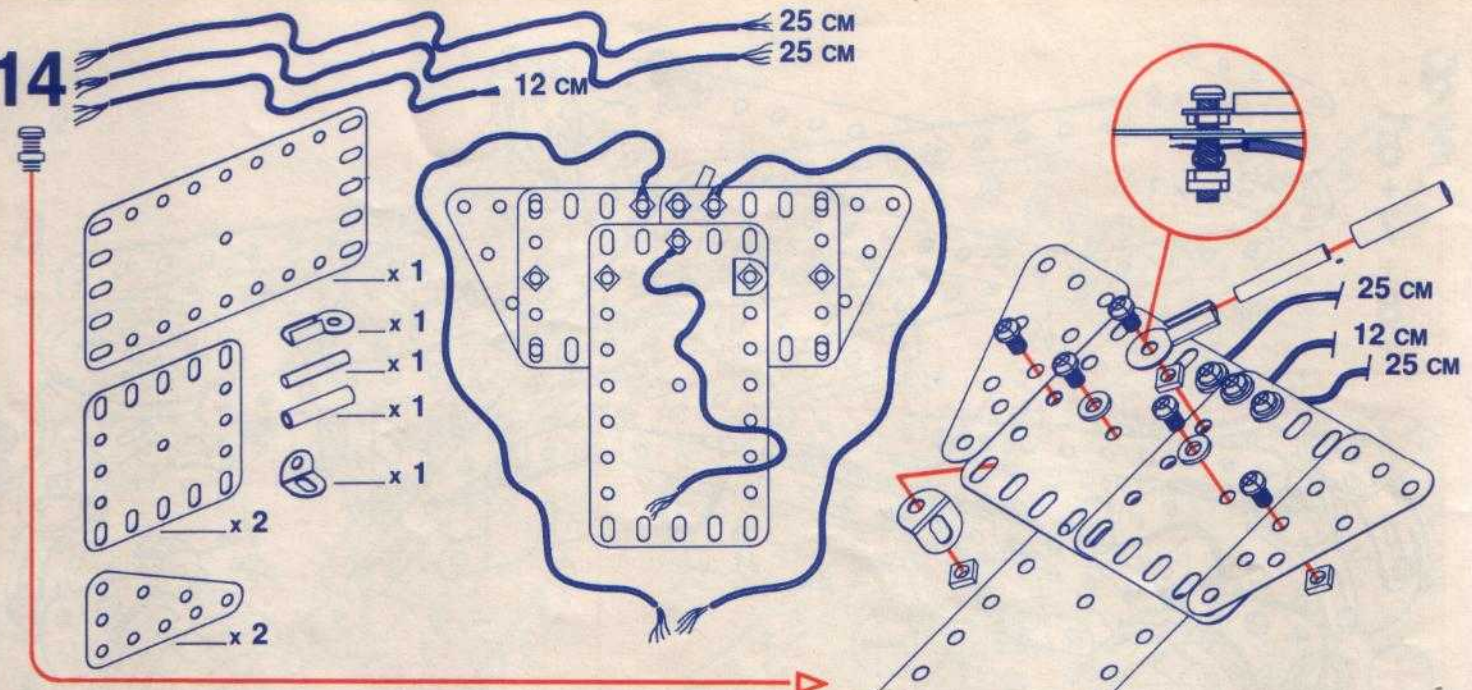

15

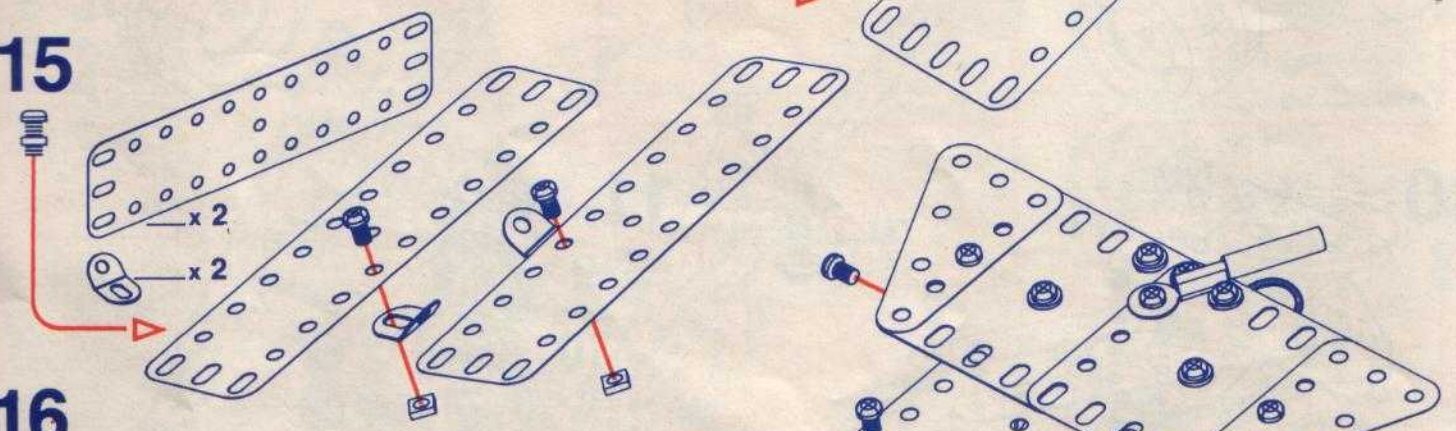

16

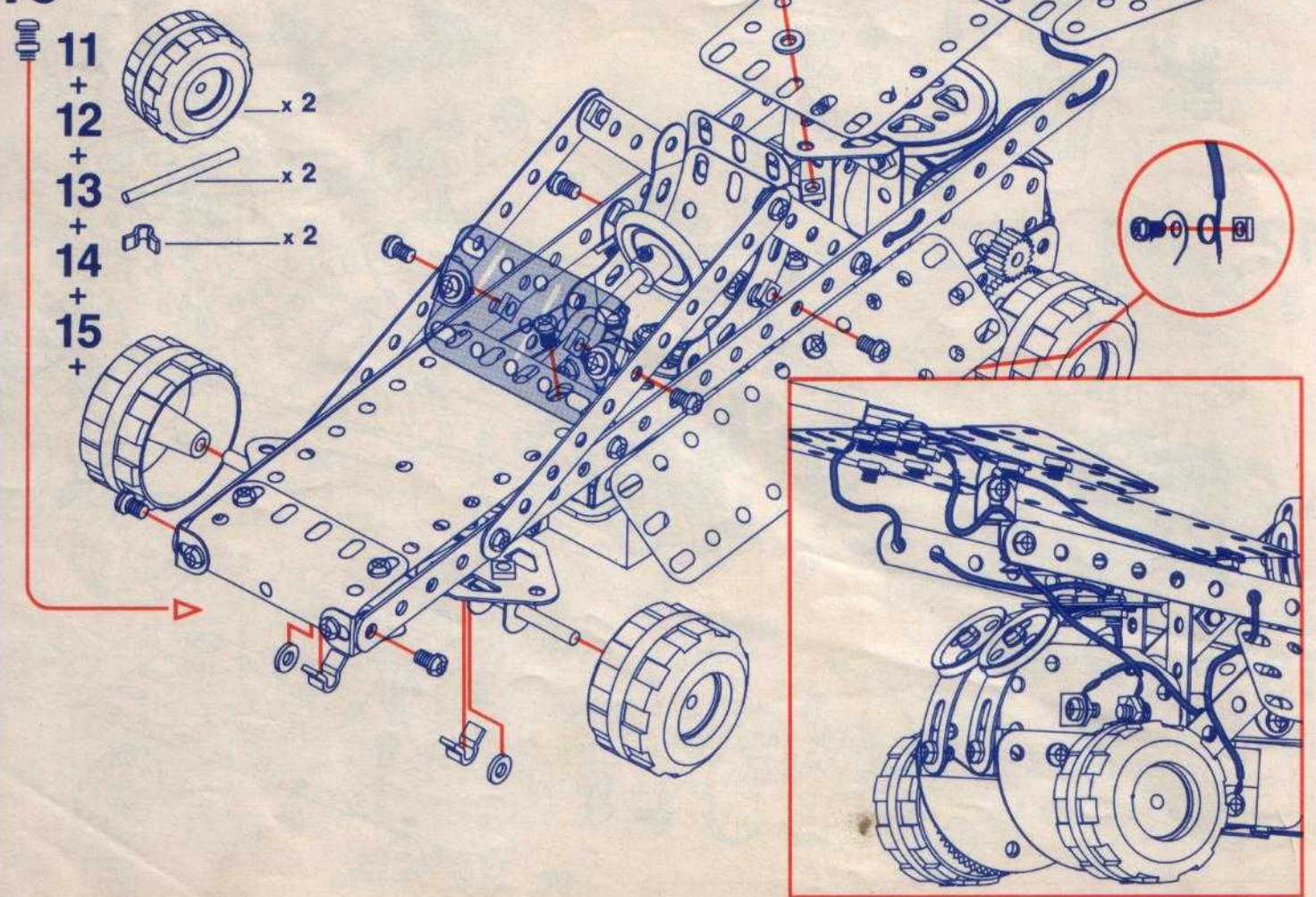

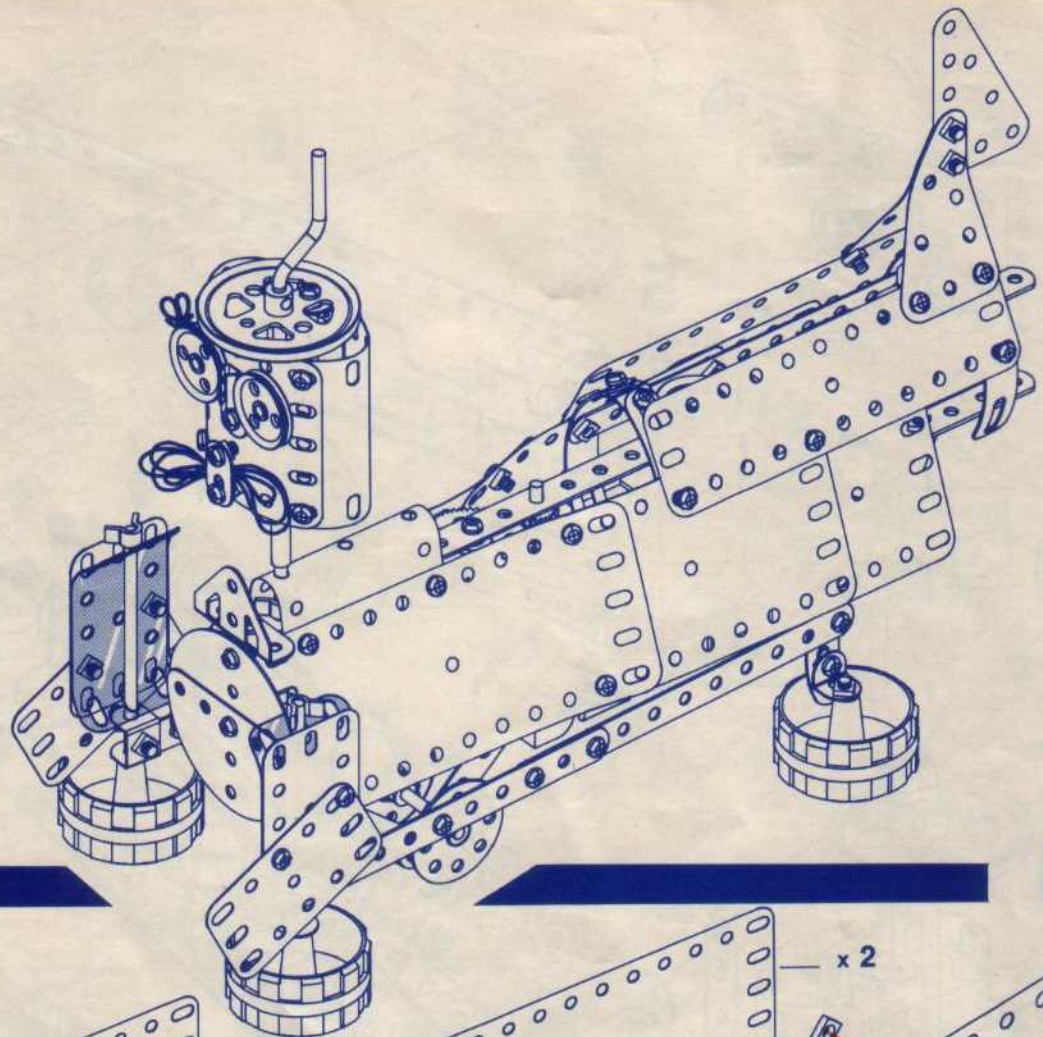

Meccanoide
Meccanoide

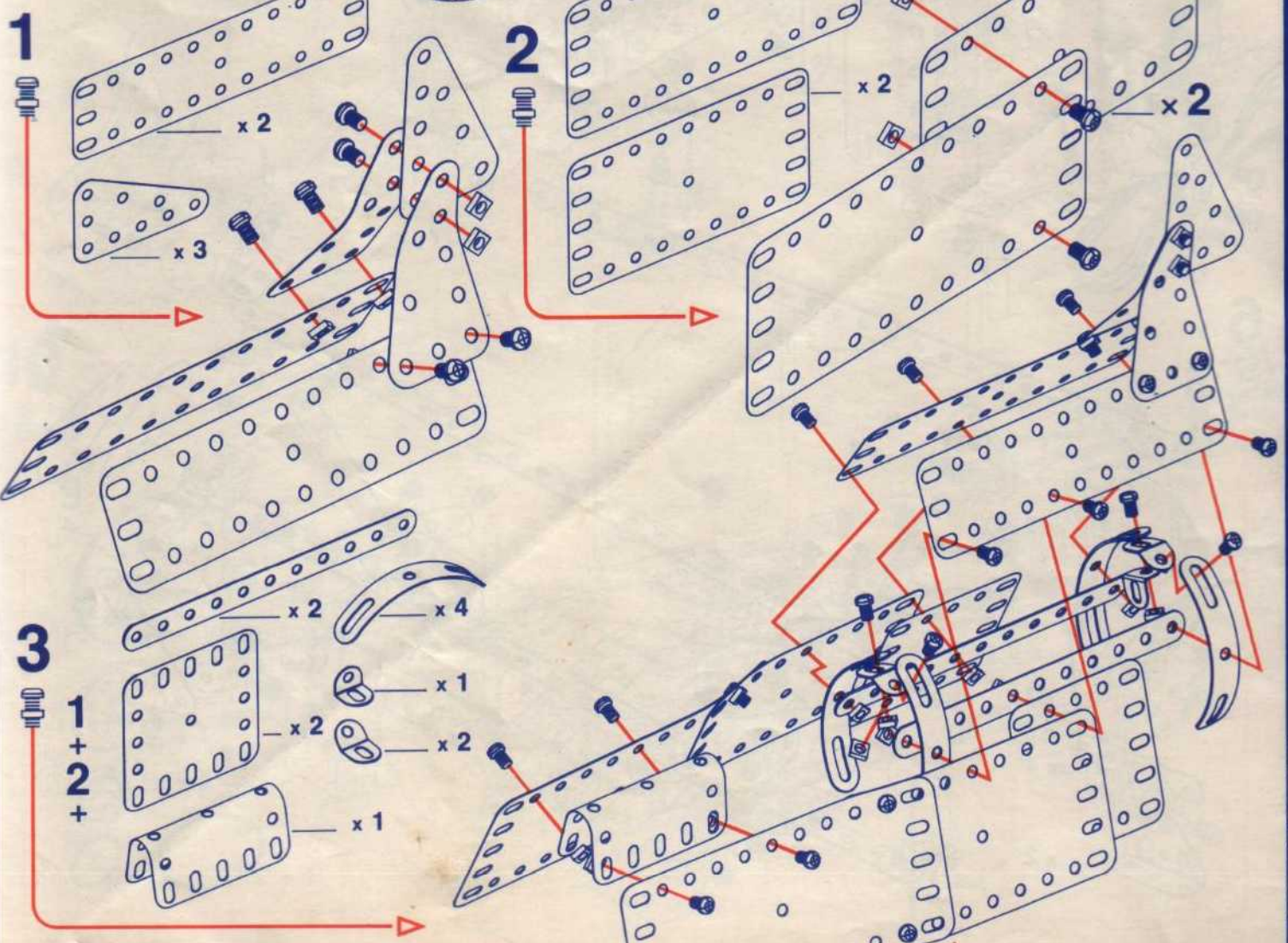

4

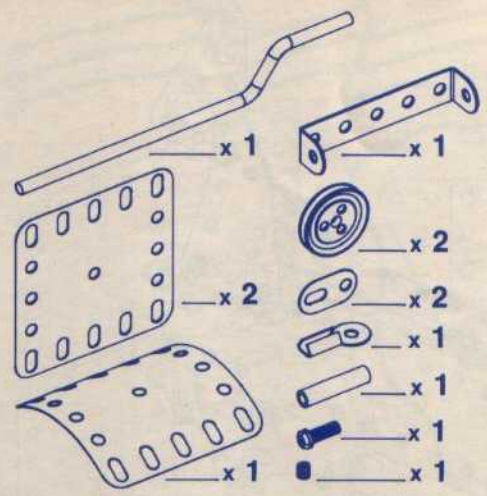

5

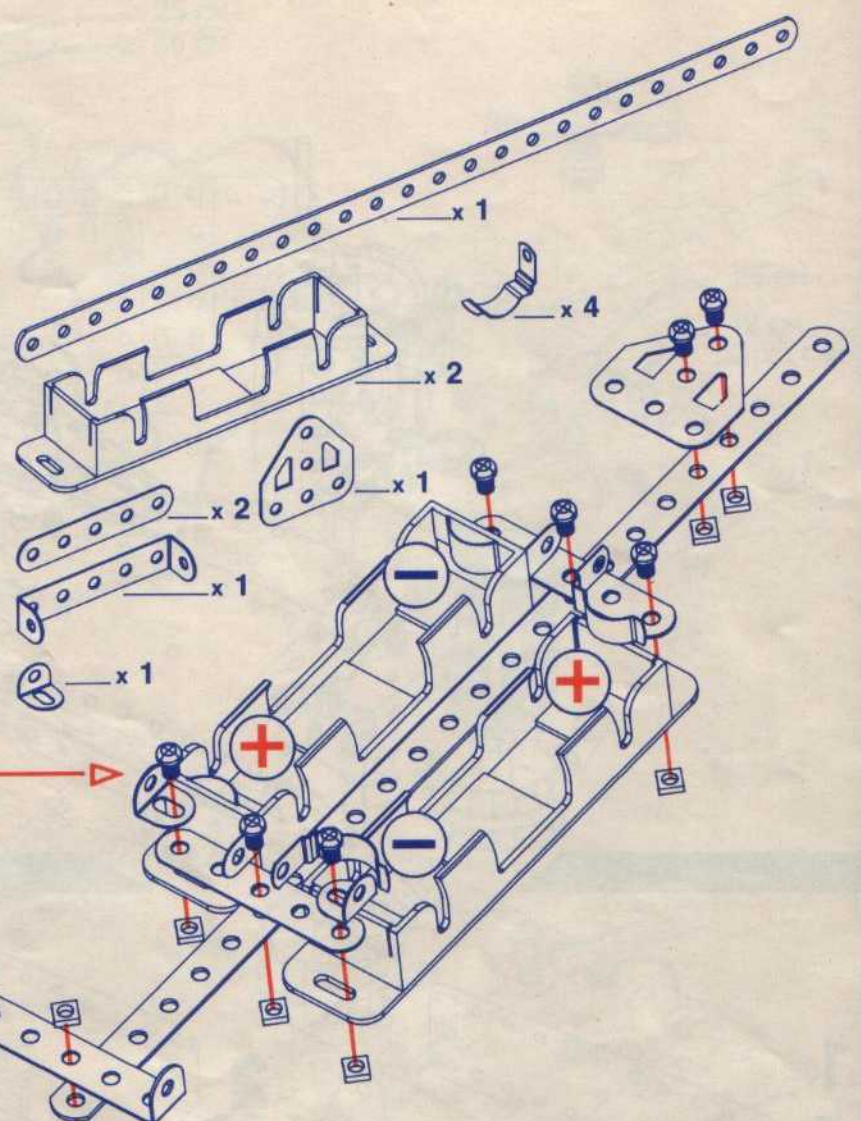

6

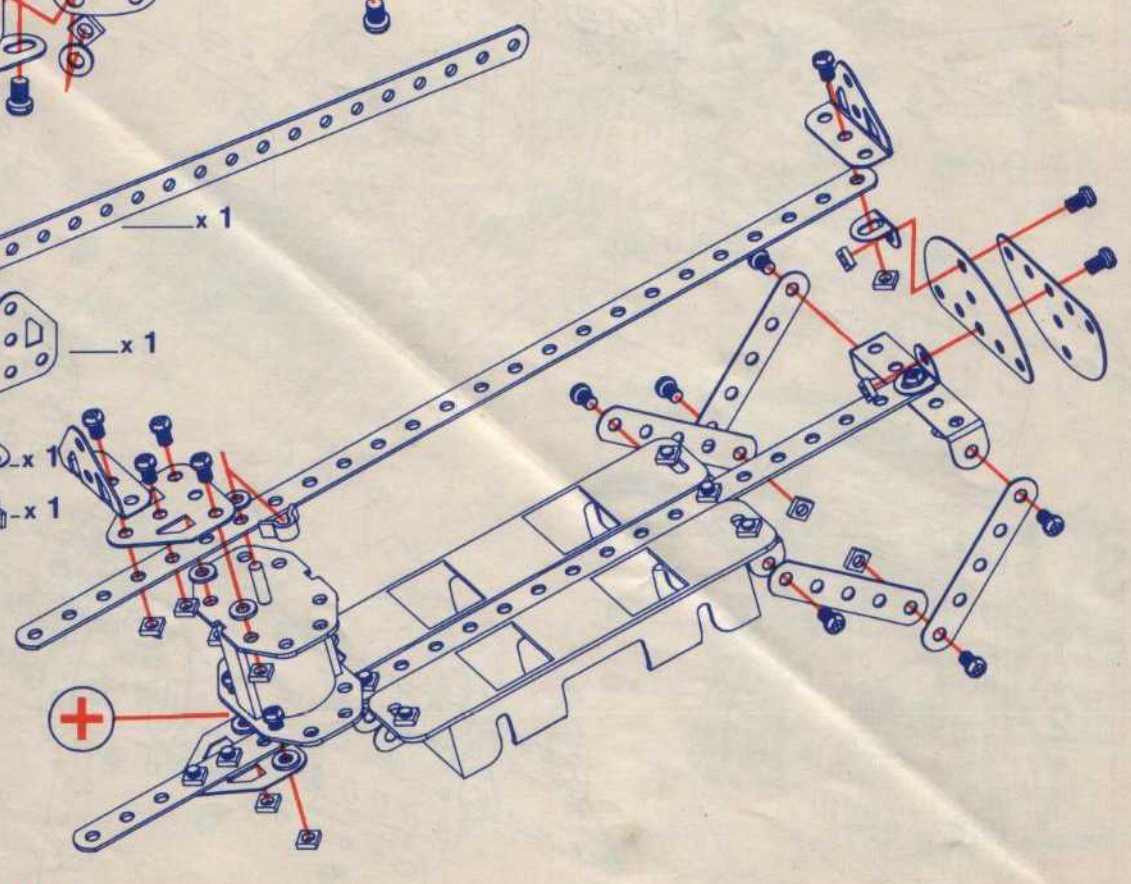
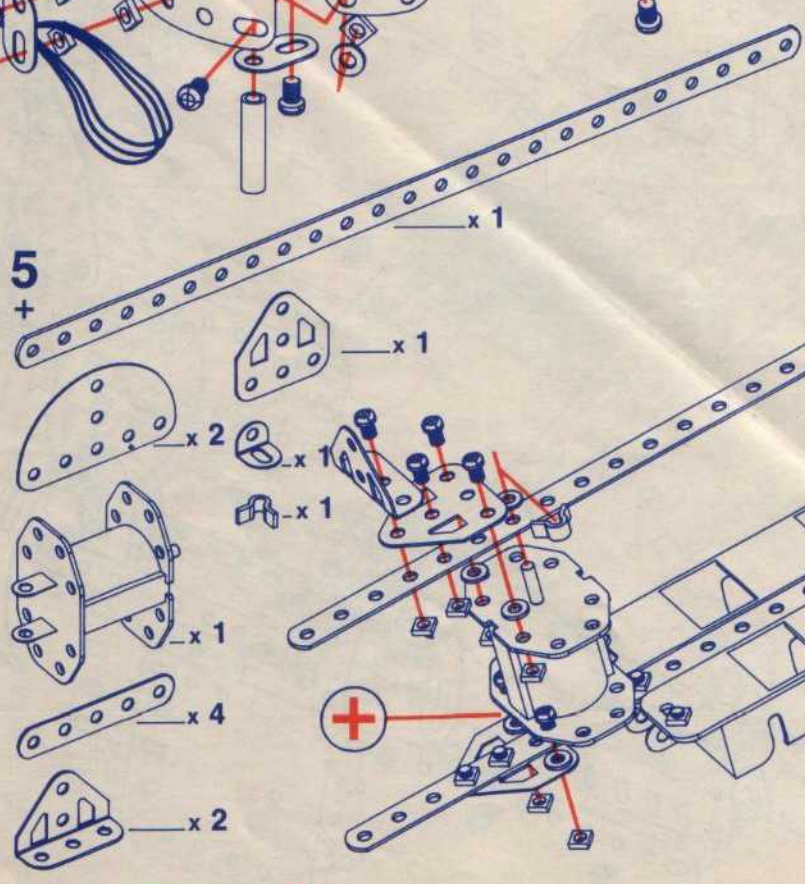

7

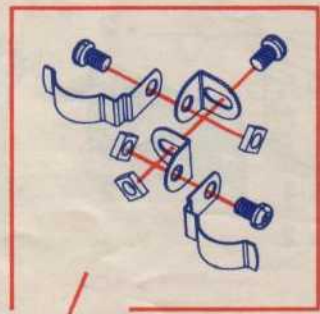
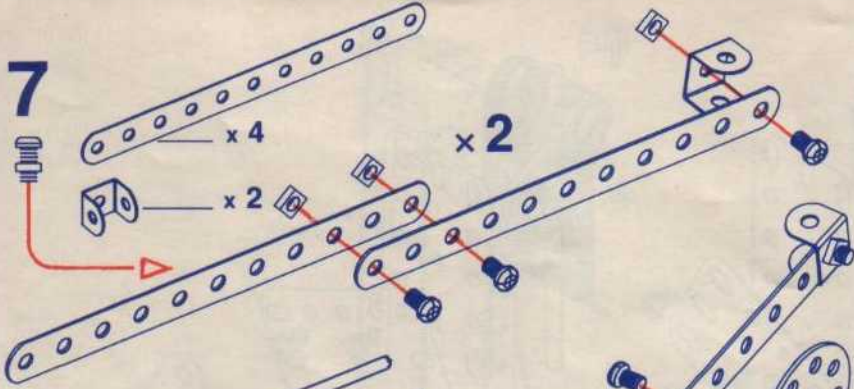

8

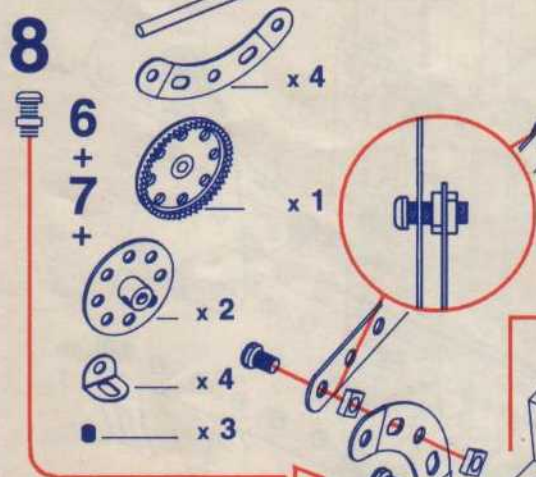

9

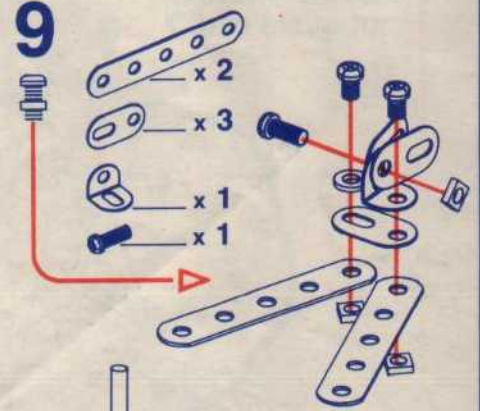

10

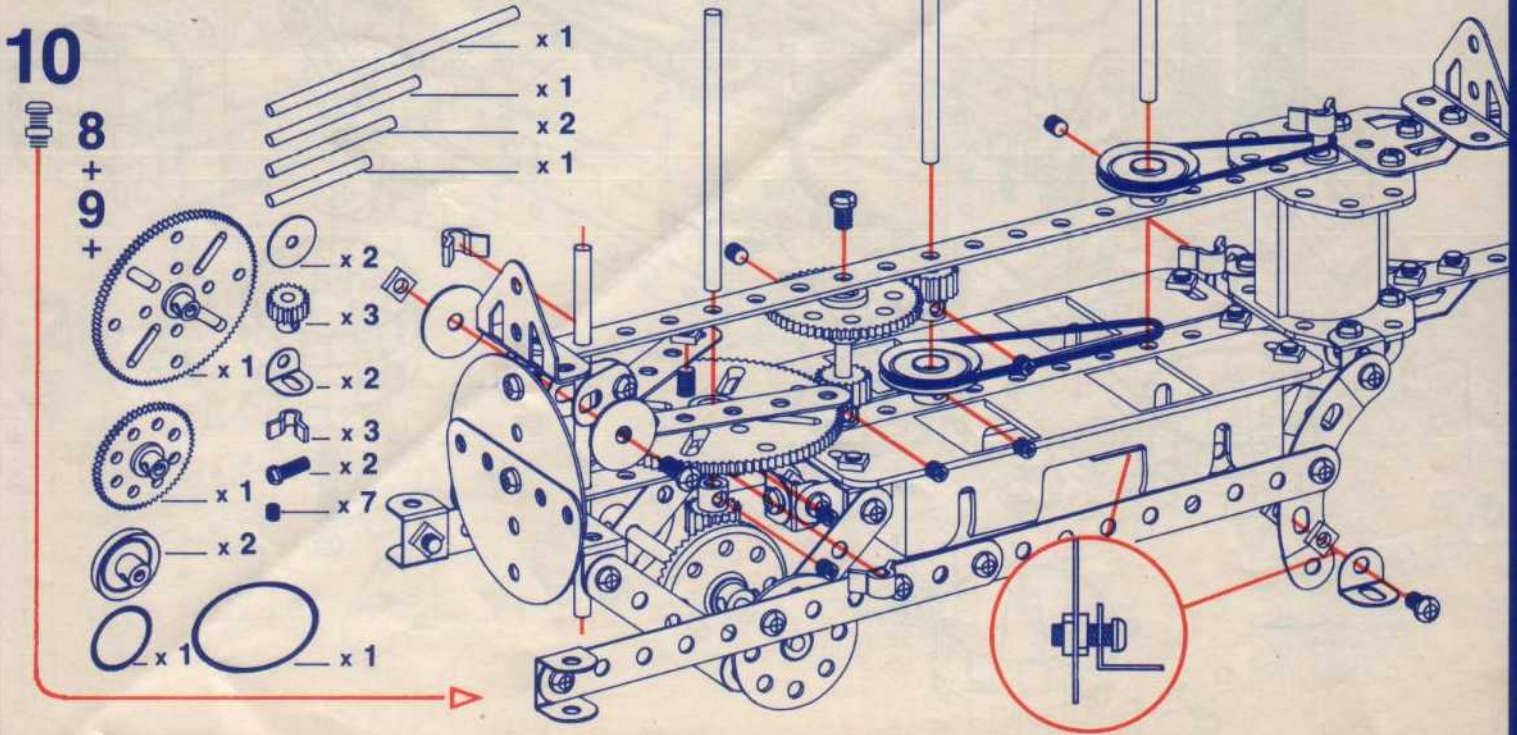
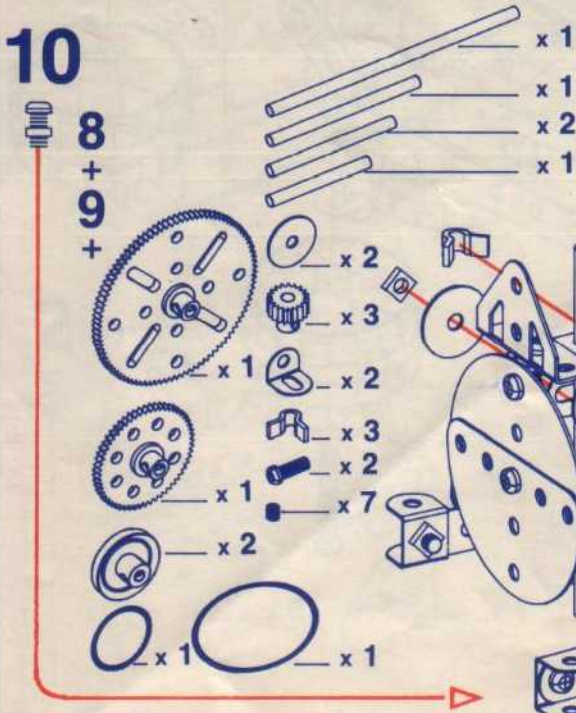

11

- x 2
- x 4
- x 2
- x 2

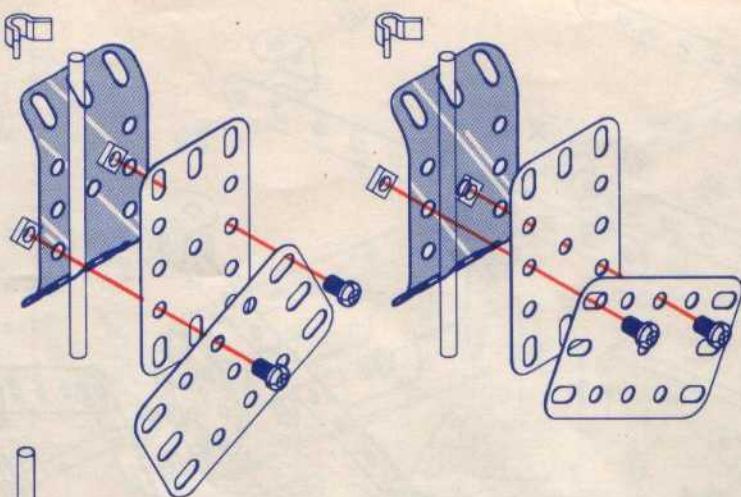

12

- 3
- 4
- 10
- 11
- x 4
- x 1
- x 1
- x 1

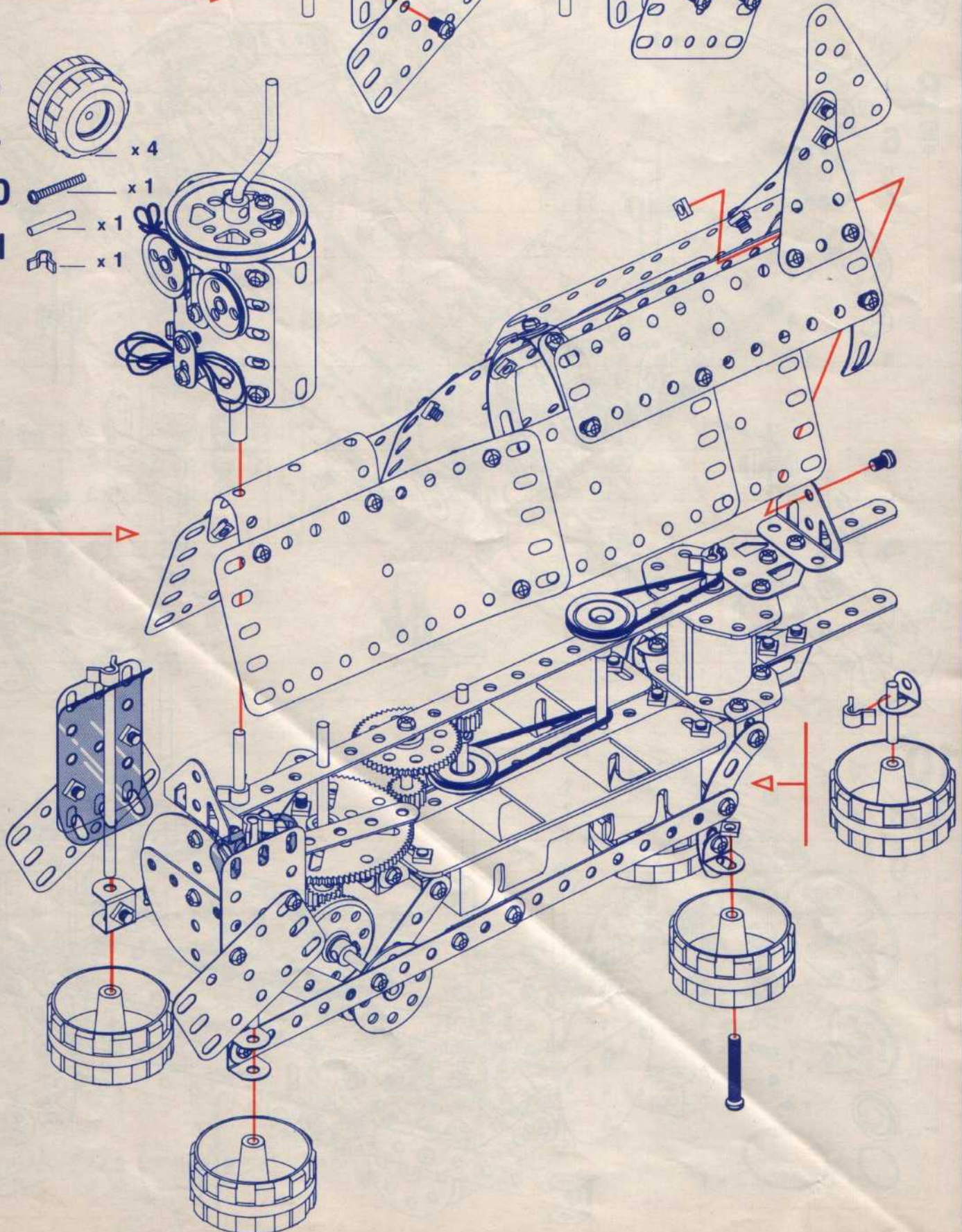

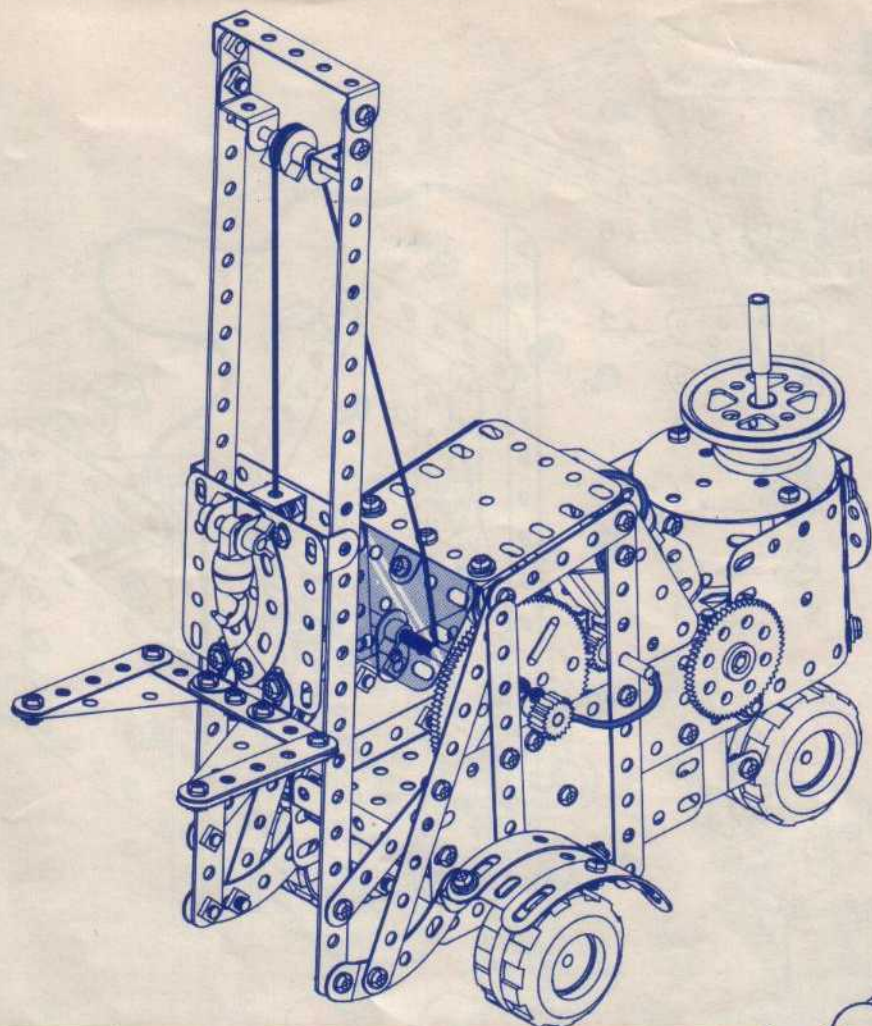

Fork-lift truck
 Chariot élévateur
 Hubstapler
 Heftruck
 Carrello elevatore
 Carro elevador

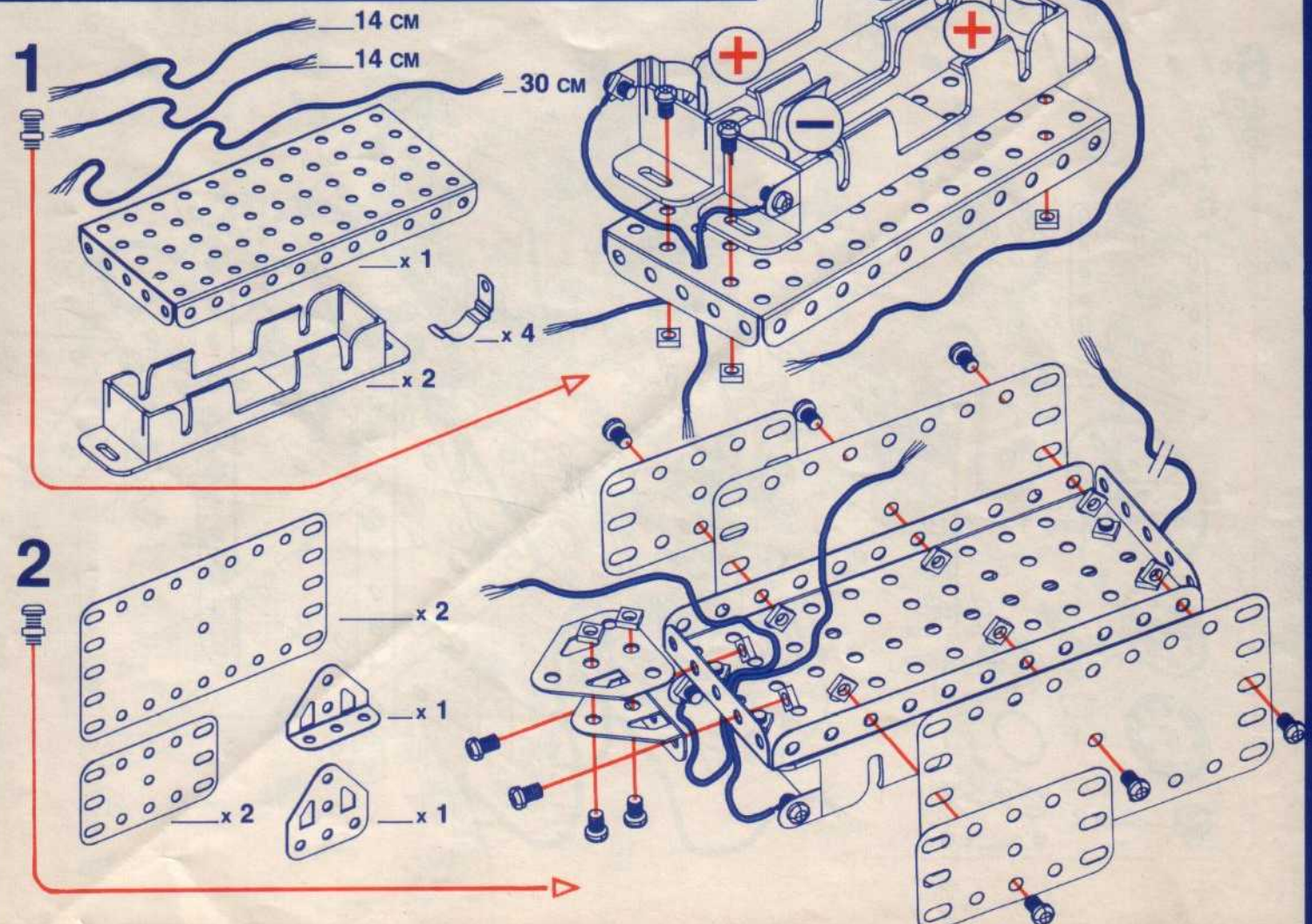

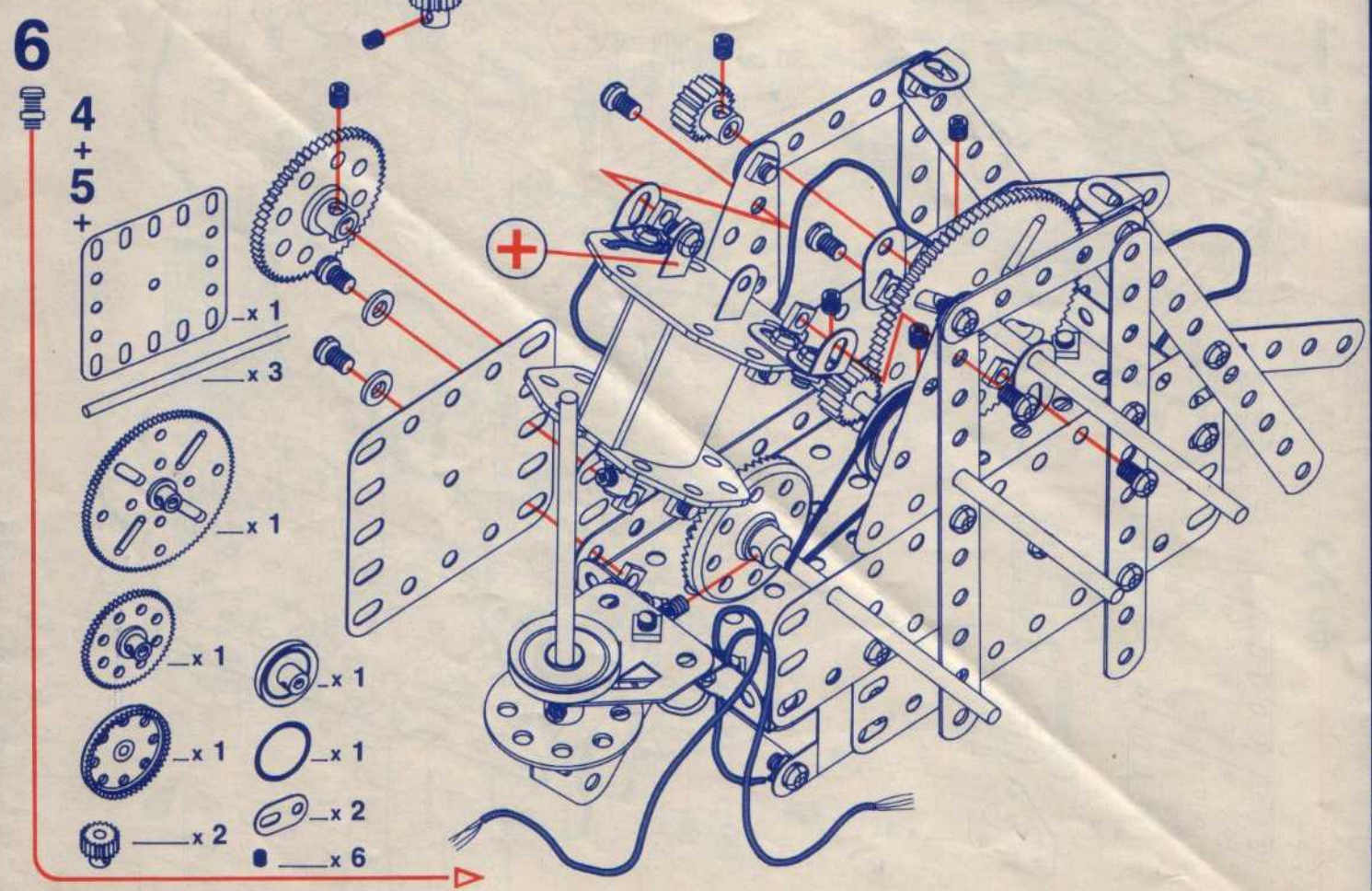
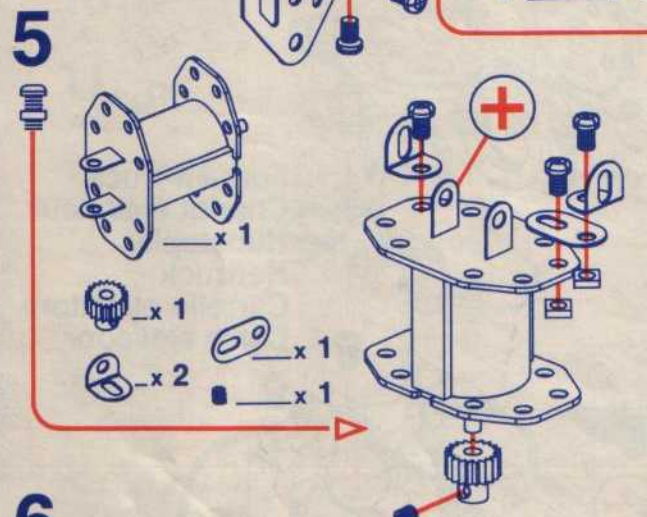
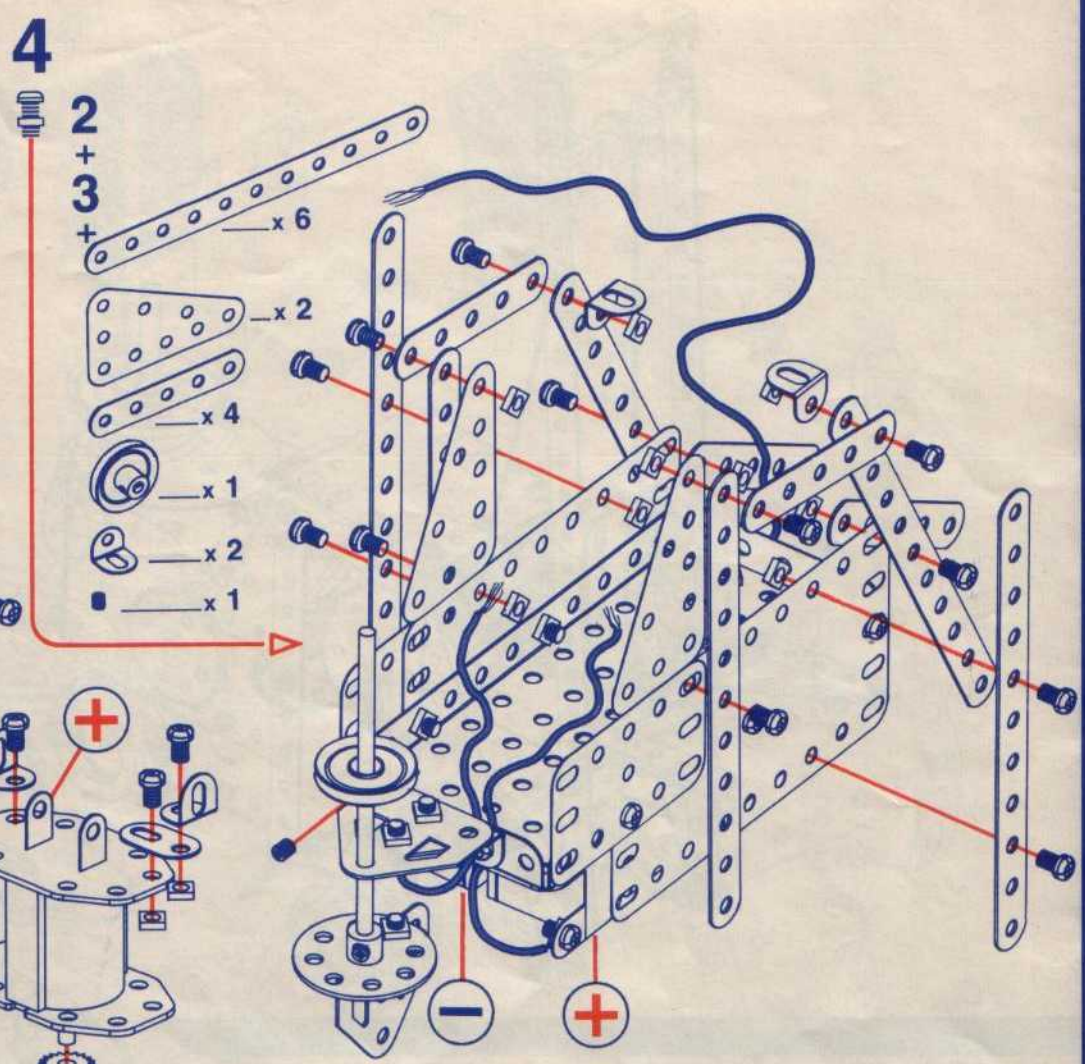
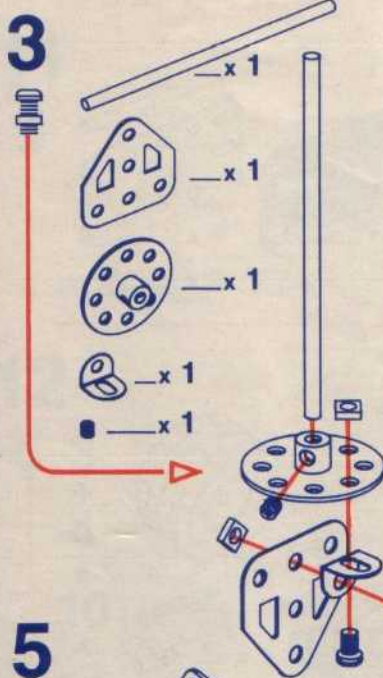

7

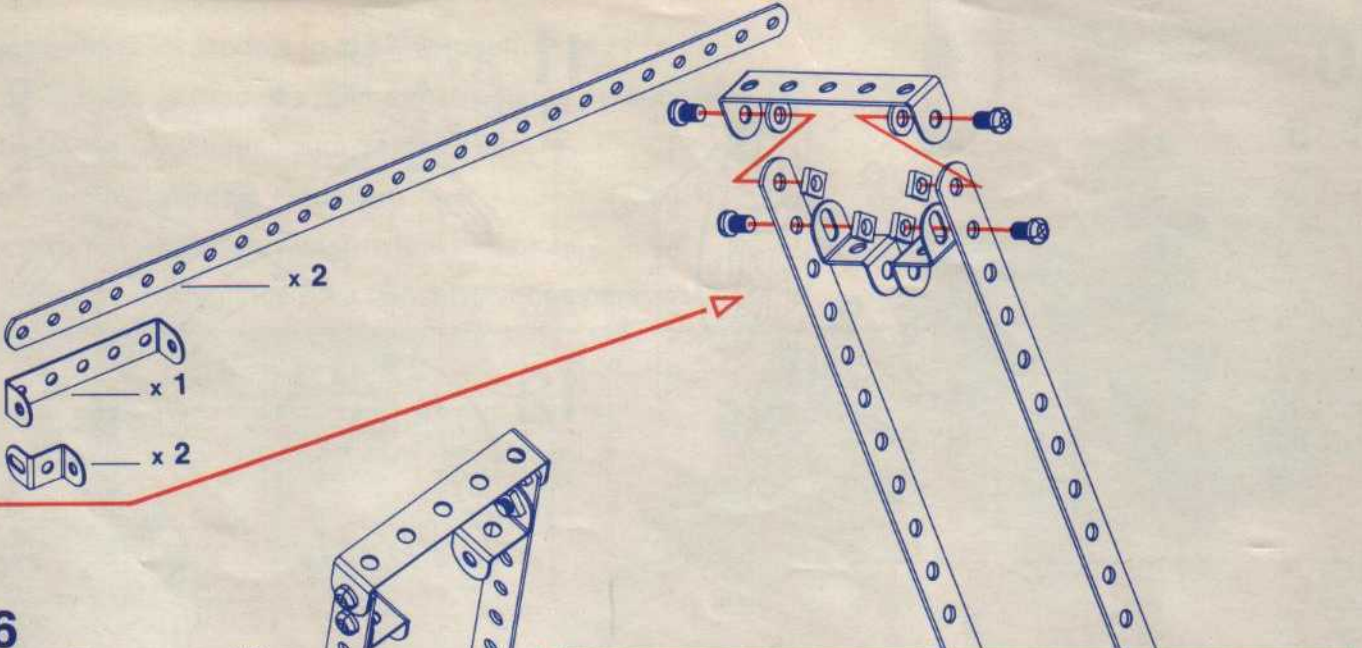

8



6 + 7 + 12 CM

- x 1
- x 1
- x 2
- x 1
- x 1
- x 1
- x 4
- x 2
- x 1

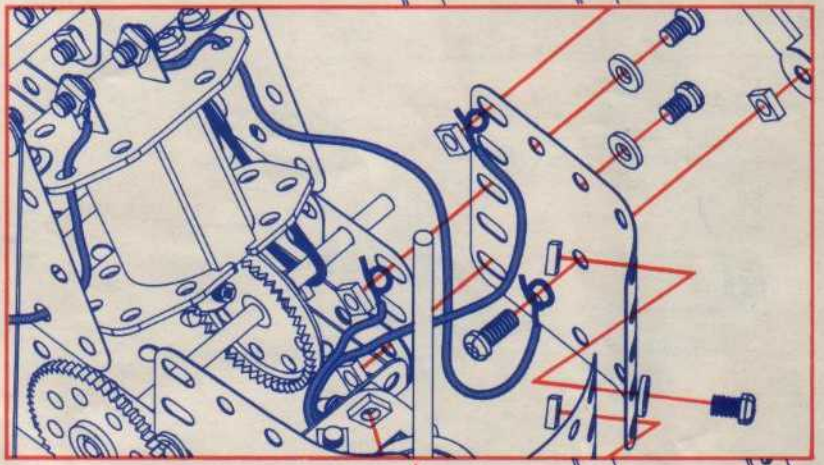

9



- x 1
- x 1
- x 2
- x 2
- x 1

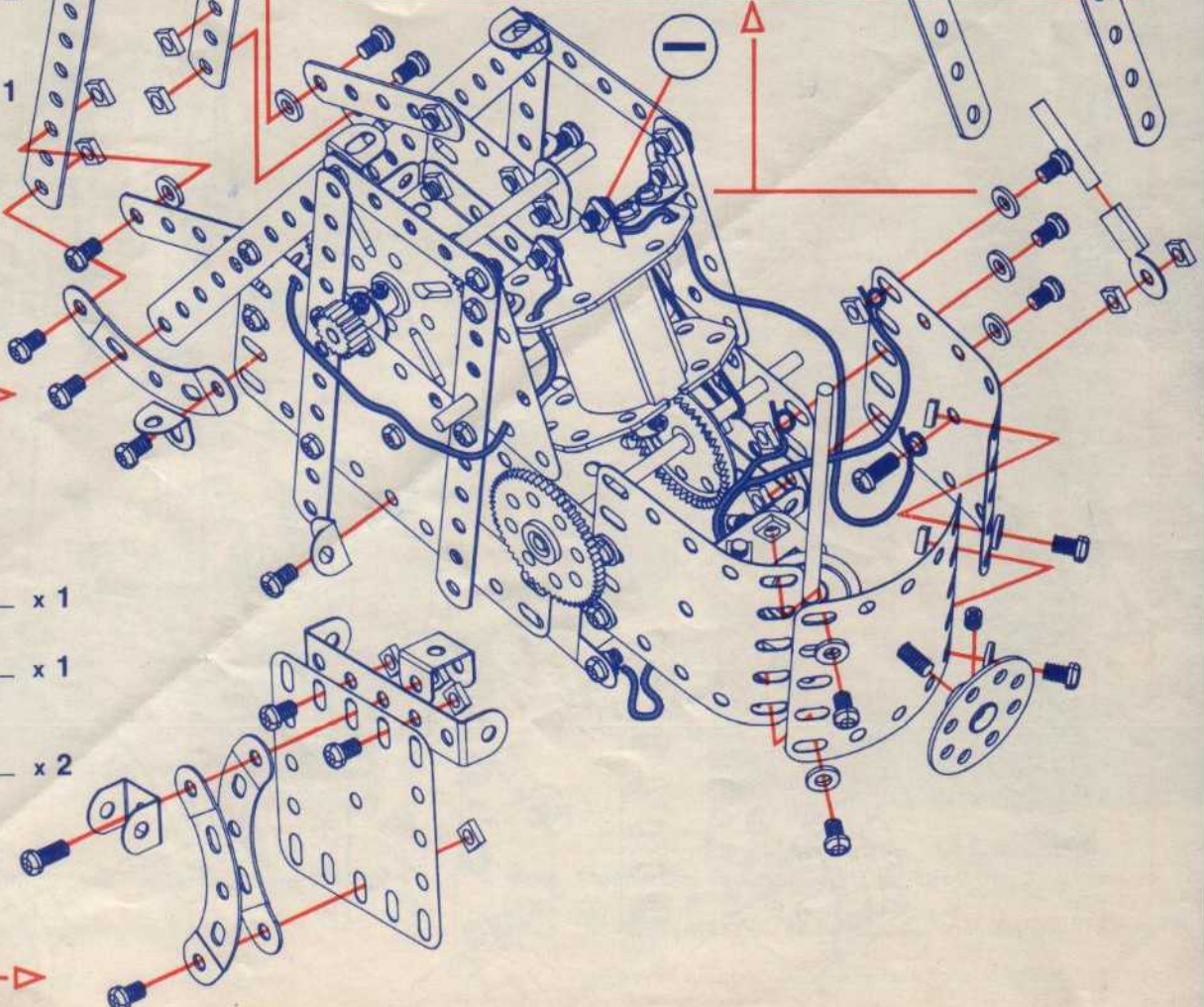

10

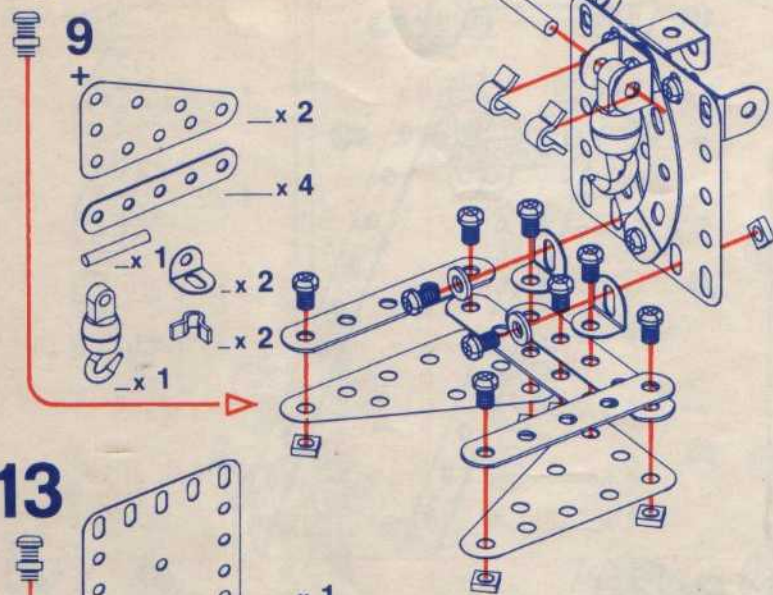

11

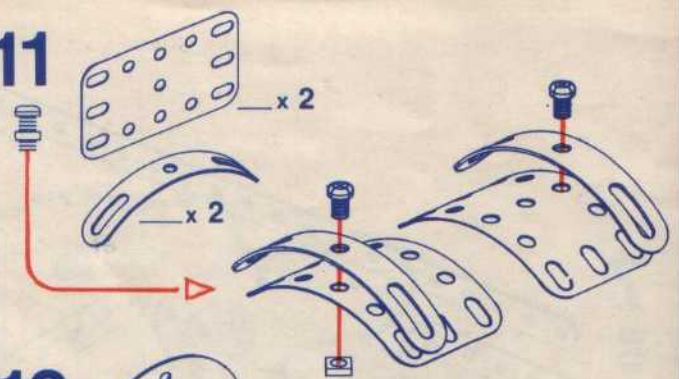

12

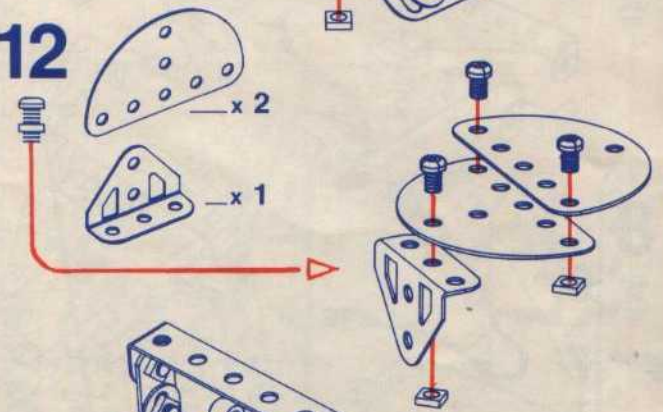



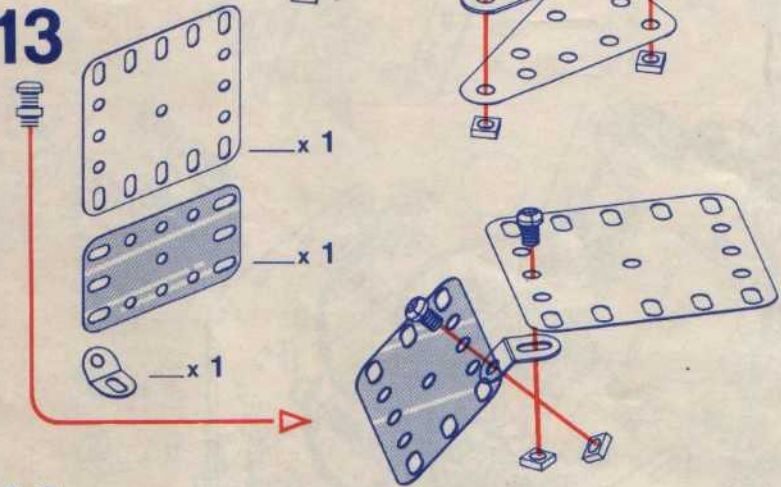

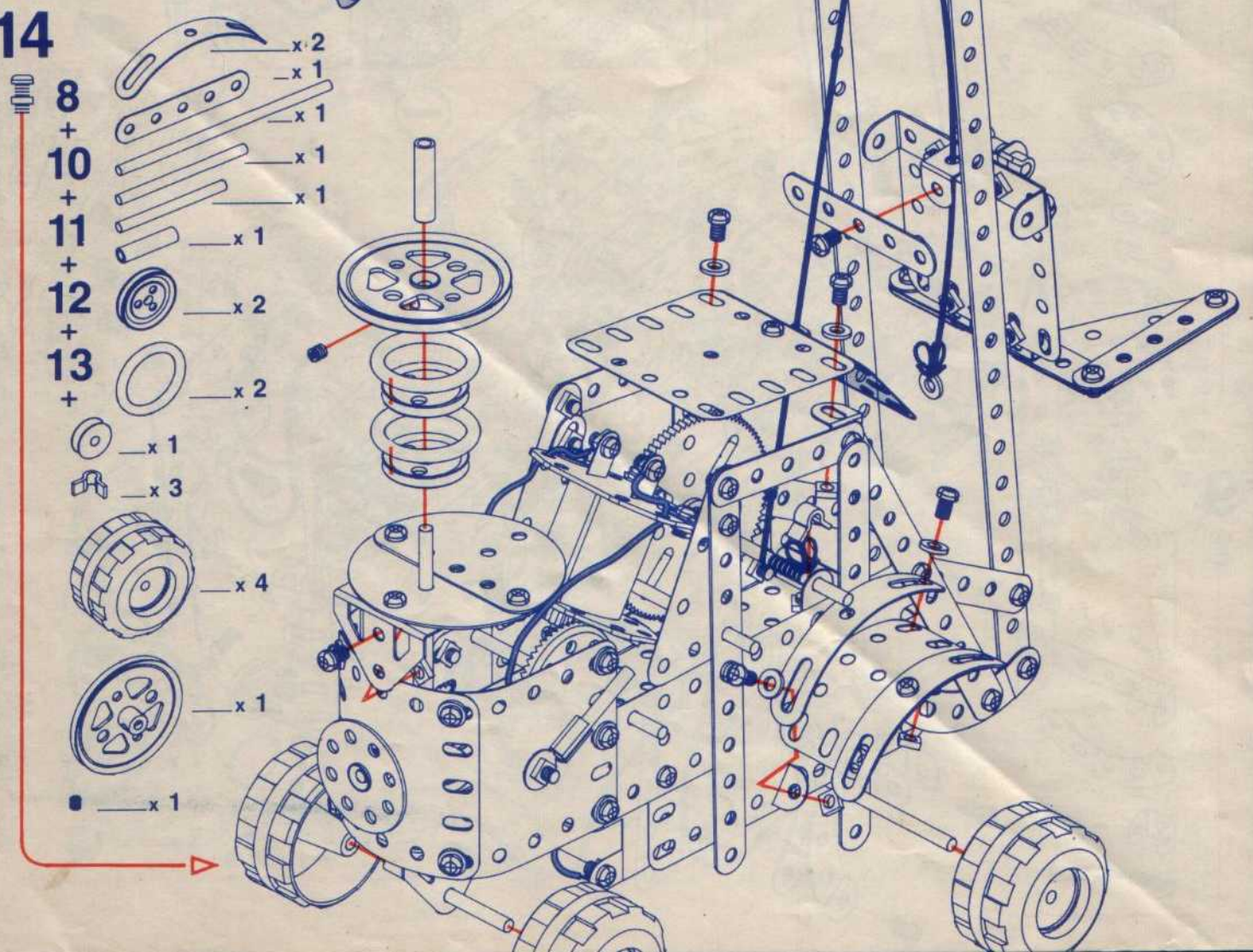

13





14



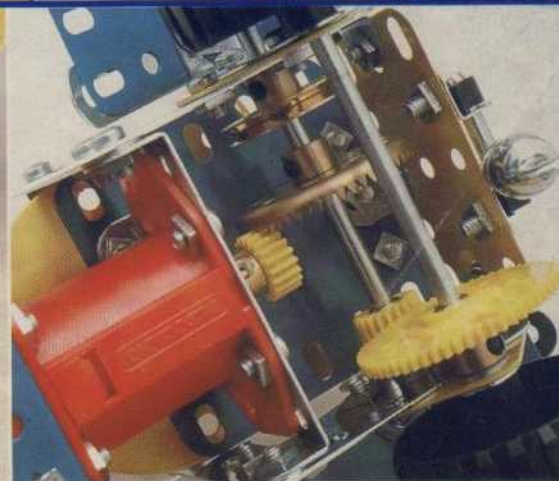
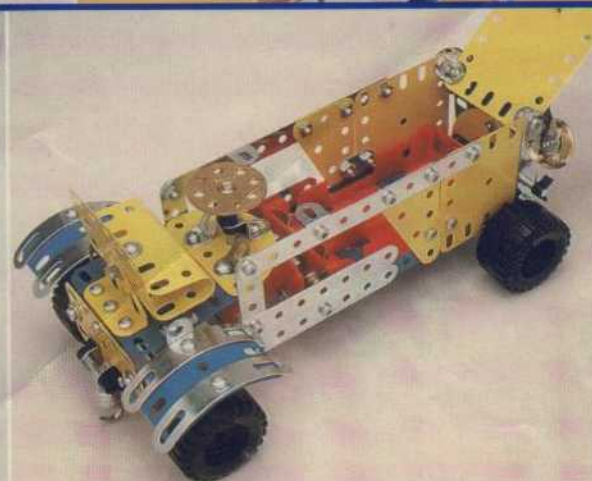
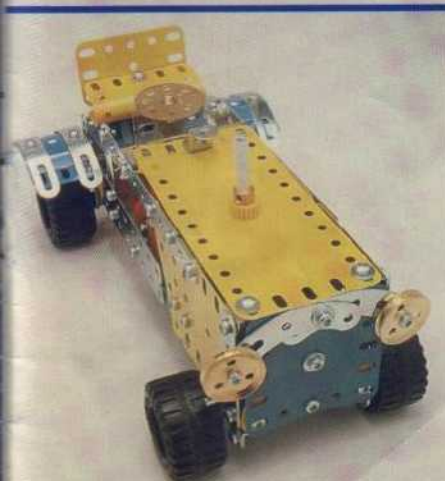
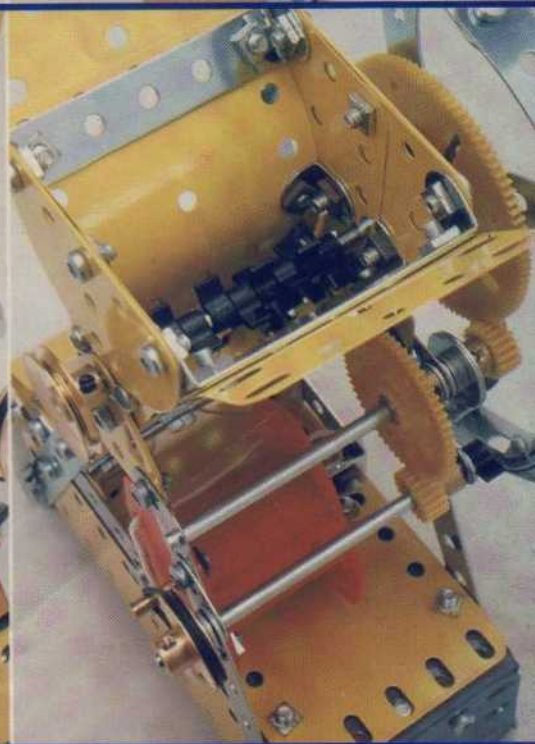
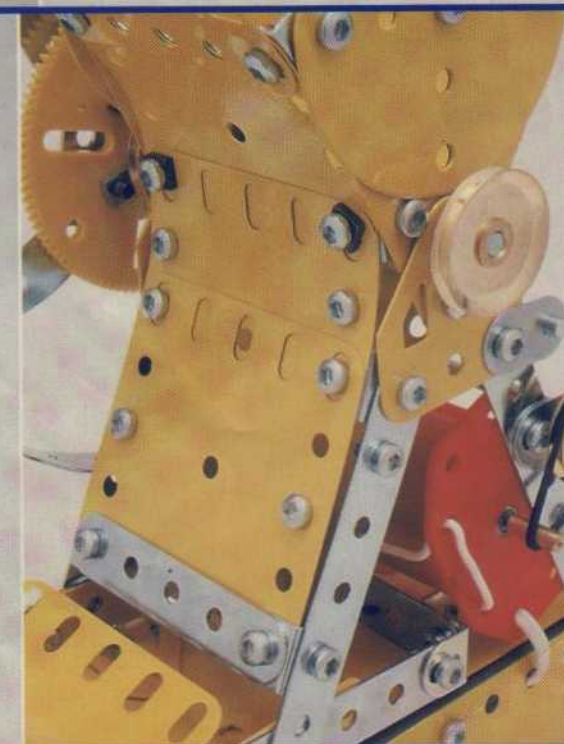
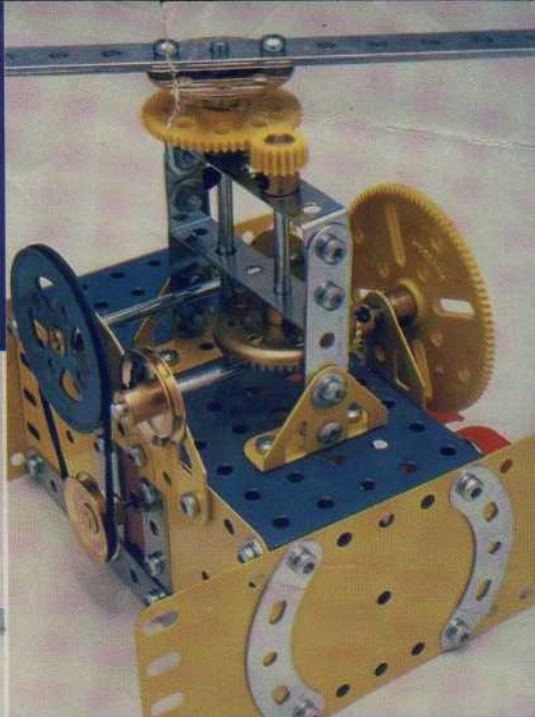
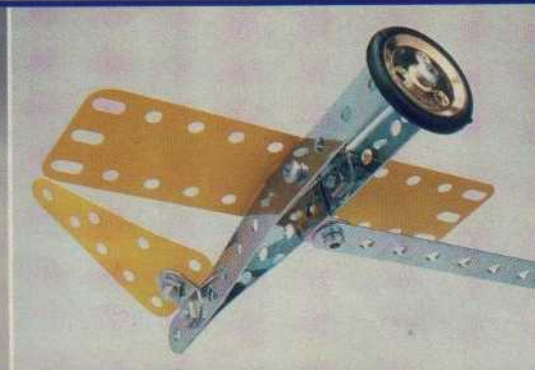

-  Suggestions for models to build yourself.
-  Propositions de modèles pour constructions personnelles.
-  Vorschläge für Modelle zum Selberbauen.
-  Ideën voor zelfbouw-modellen.
-  Proposte di modelli per costruzioni personali.
-  Propuestas de modelos para construcciones personales.





 Fitting the electric motor: see instruction book 2 page 3.

 Montages électriques: voir notice 2 page 3.

 Elektrische Montage: Siehe Notiz 2 Seite 3.

 Elektrische aansluitingen: zie lijst 2 blz. 3.

 Montaggi elettrici: vedere manuale d'istruzioni 2 pagina 3.

 Montajes eléctricos: vease folleto 2, pagina 3.



Models to build yourself.



Zelfbouw-modellen.



Modèles pour constructions personnelles.



Modelli per costruzioni personali.



Modelle zum Selberbauen.



Modelos para construcciones personales.

4

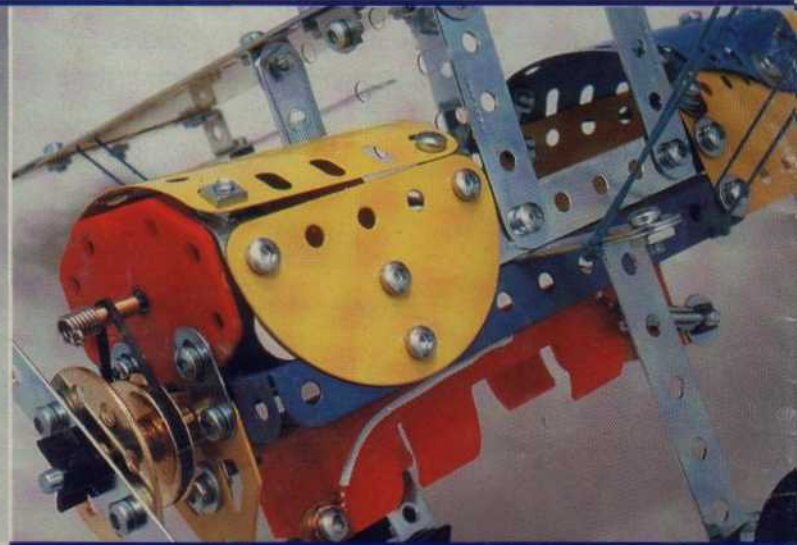
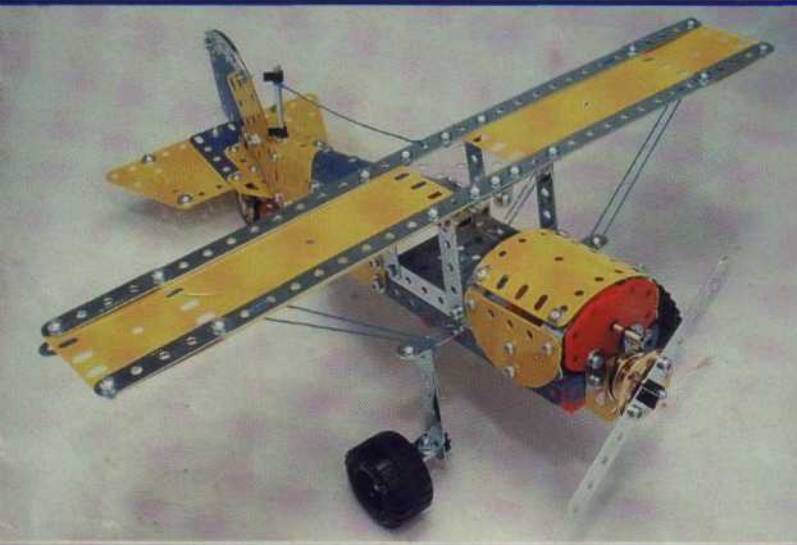

model box n° 5
modèle boîte n° 5

n° 4 + n° 4x = n° 5



n° 4 + boîte mécanisme =

