











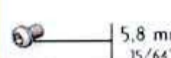

1

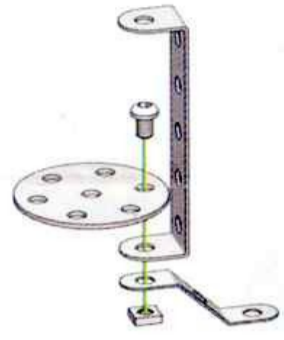
-  x1
-  x1
-  x1
-  x1
-  x1
-  x1

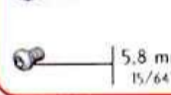

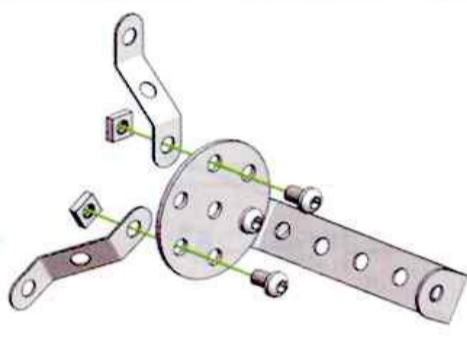

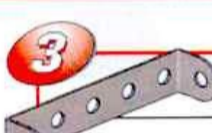
-  x2
-  x2
-  x2



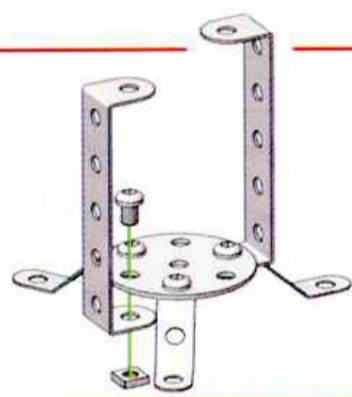



-  x1
-  x1
-  x1

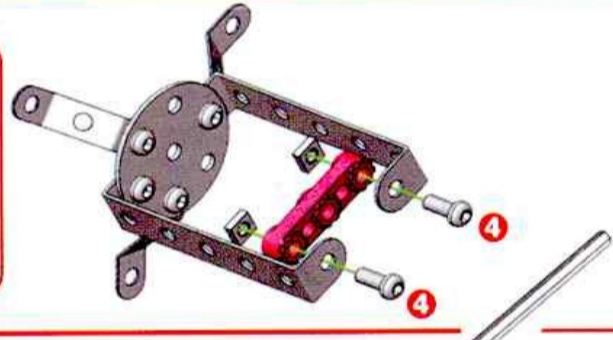

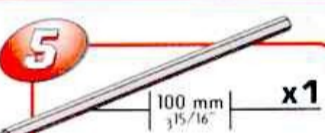



-  x1
-  x2
-  x2

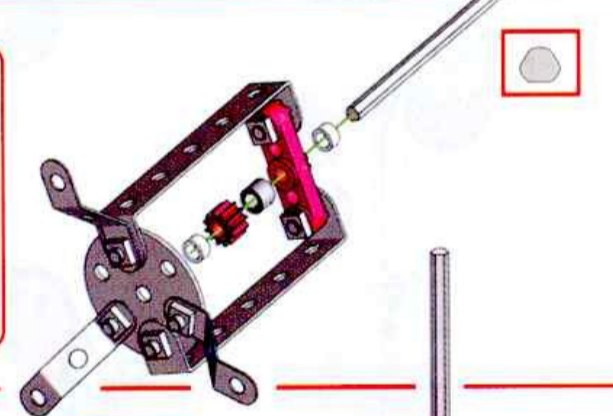

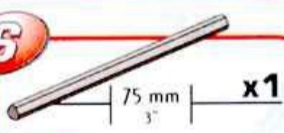



-  x1
-  x1
-  x1
-  x2

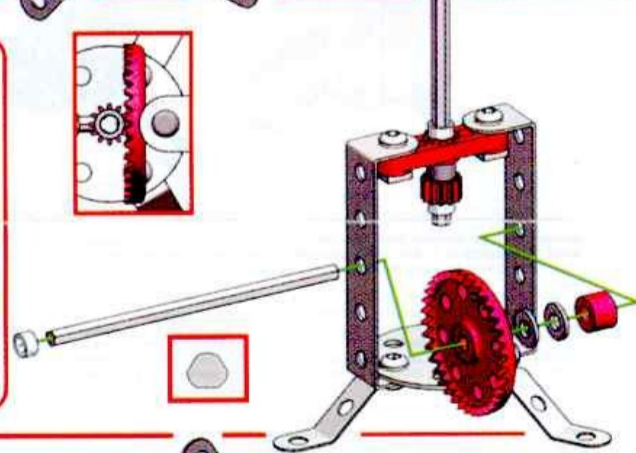



-  x1
-  x1
-  x1
-  x2
-  x1

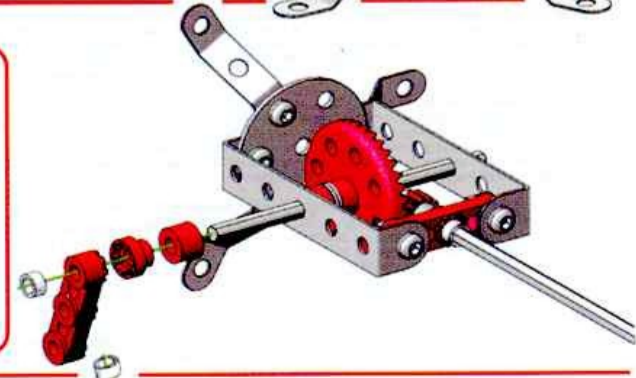

-  x1
-  x1
-  x1
-  x1



-  x1
-  x1

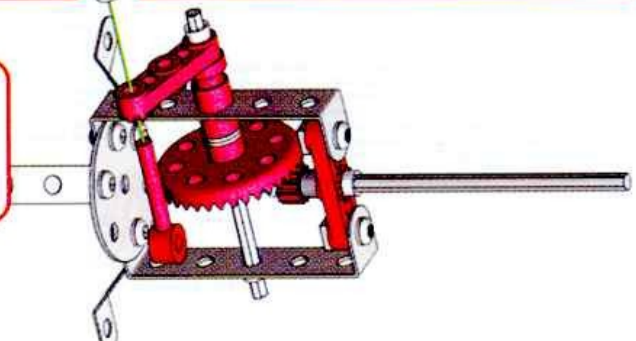

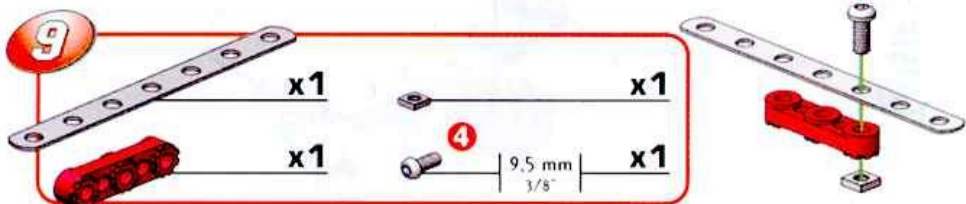

9

x1

x1

x1

9,5 mm
3/8"

x1

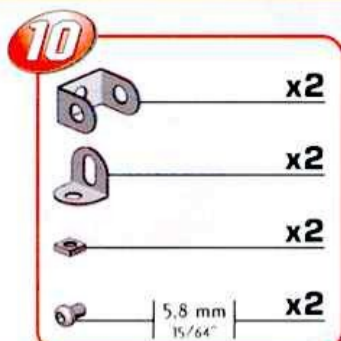

10

x2

x2

x2

5,8 mm
5/84"

x2

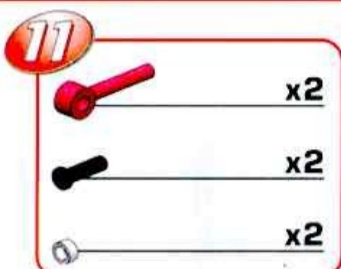
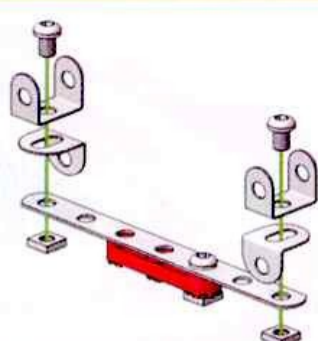

11

x2

x2

x2

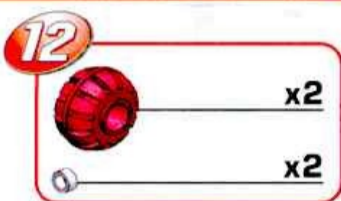
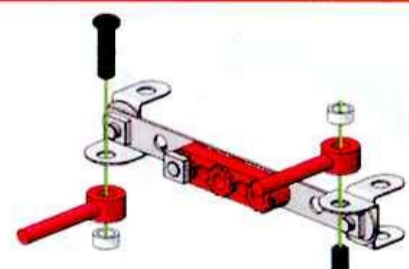

12

x2

x2

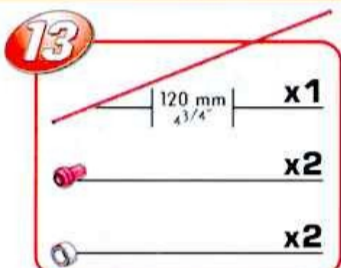
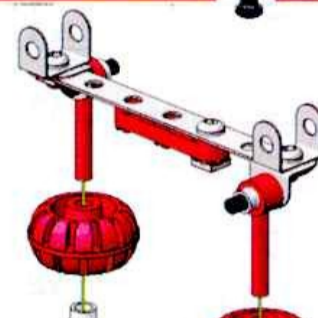

13

120 mm
4 3/4"

x1

x2

x2

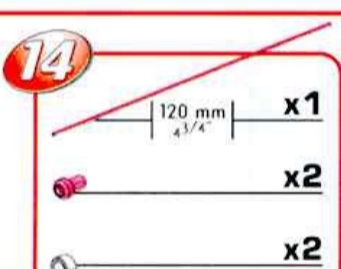
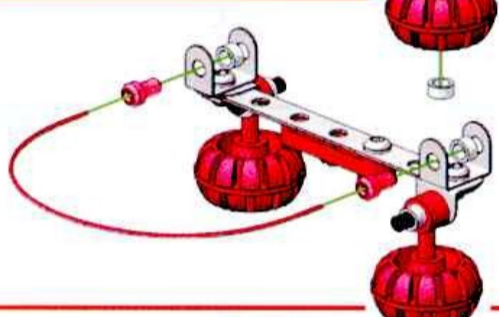

14

120 mm
4 3/4"

x1

x2

x2

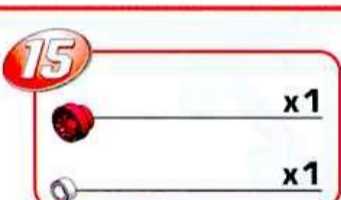
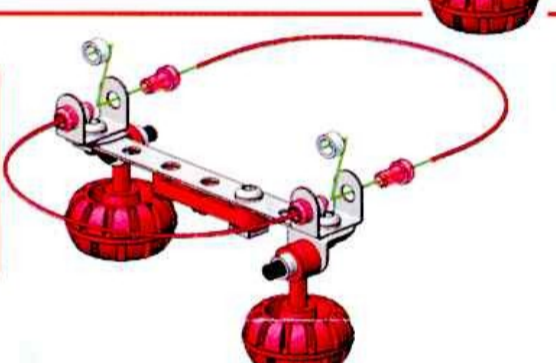

15

x1

x1

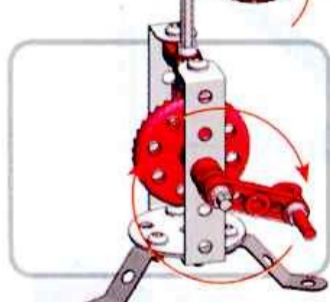
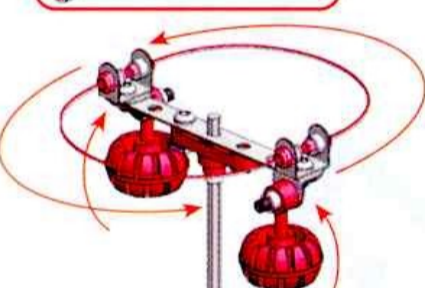

GB : Many of the models and component parts are unique and original designs which are the property of MECCANO S.A. They are protected by national legislation as industrial designs, trademarks and/or copyrights throughout many countries. For detailed information, please contact MECCANO S.A. MECCANO S.A. accepts no responsibility for (I) failure to follow instructions, (II) use for any purpose other than as specified in the instructions (III) any alteration of any parts or components.

F : De nombreux modèles et pièces sont des créations originales, propriétés de MECCANO S.A. et sont protégés par les législations nationales sur les dessins et modèles, marques et/ou droits d'auteurs. Pour toute information, merci de contacter : MECCANO S.A. La responsabilité de MECCANO S.A. ne saurait être engagée en cas d'accident survenu à la suite (I) du non respect des instructions de montage (II) d'une utilisation des pièces autre que celle proposée dans la notice (III) d'une altération ou de la modification des pièces.

D : Zahlreiche Modelle und Teile sind Erfindungen und Eigentum der Firma MECCANO S.A. Sie sind durch Inland-Gesetze über Zeichnungen und Modelle sowie Warenzeichen und/oder Urheberrechte geschützt. Für zusätzliche Auskünfte wenden Sie sich bitte an: MECCANO S.A. Die Firma MECCANO S.A. haftet nicht für Unfälle, die aus der (I) Nichteinhaltung der Bauanleitung, der (II) Verwendung anderer als in der Bauanleitung angegebenen Teile oder der (III) Änderung oder Modifikation der Teile resultieren.

I : Numerosi modelli e pezzi sono creazioni originali della MECCANO S.A. e sono protetti dalle legislazioni nazionali sui disegni e modelli, marchi e/o diritti d'autore. Per qualsiasi informazione, vogliate prendere contatto con: MECCANO S.A. MECCANO S.A. declina ogni responsabilità in caso d'incidenti sopravvenuti in seguito a: (I) non rispetto delle istruzioni di montaggio (II) utilizzo dei pezzi per funzioni diverse da quelle previste nel manuale (III) alterazione e/o modifica dei pezzi.

E : Numerosos modelos y piezas son creaciones originales, propiedades de MECCANO S.A. y están protegidos por las legislaciones nacionales en lo que concierne a los dibujos y modelos, marcas y/o derechos de autor. Para cualquier información, sírvase ponerse en contacto con: MECCANO S.A. MECCANO S.A. carece de responsabilidad en caso de accidente debido a: (I) el incumplimiento de las instrucciones de montaje (II) una utilización de las piezas diferente a la que se indica en las instrucciones (III) una alteración o modificación de las piezas.

P : Vários modelos e peças são criações originais, propriedades da MECCANO S.A. e são protegidos pelas legislações nacionais relativas aos desenhos e modelos, às marcas e/ou aos direitos de autor. Para qualquer informação, é favor contactar: MECCANO S.A. A Sociedade MECCANO S.A. não poderá ser responsabilizada pelos acidentes provocados: (I) pela falta de cumprimento das instruções de montagem (II) pelo uso indevido das peças ou (III) pela modificação ou alteração das peças.

S : Många modeller och delar bildar en unik och originell formgivning vilken är MECCANO S.A. egendom. Dessa modeller och delar är skyddade genom lagstiftning såsom industriell formgivning, varumärke och/eller upphovsrättsligt i ett flertal länder. För mer detaljerad information, var vänlig och kontakta MECCANO S.A. MECCANO S.A. fraktar sig allt ansvar i händelse av olycka till följd av (I) att monteringsinstruktionerna inte har respekterats (II) en annan användning av delarna än den som står i anvisningen (III) en förändring eller förändring av delarna.

FIN : Vore mange modeller og dele er originale fremstillinger og ejes af MECCANO S.A. Tegninger, modeller, fabriksmærker og ophavsret er lovbeskyttede i flere land. Yderligere oplysninger kan laves hos: MECCANO S.A. MECCANO S.A. er vistaa ei katta seuralavista systä salfuonita onnetomuksia: (1) ohjeiden vastainen kokominen, (2) muiden kuin ohjeissa ehdotettujen osien käyttö, (3) osien vaihto tai muuntelu.

DK : Uset mallt ja osat ovat MECCANO S.A.: n omaisuutta olevaa suunnittelua. Uset mallt ja niden osat ovat lailla suojattua teollista mustelua, tavaramerkkejä jatta kopiointioikeuksia useissa maissa. Tuotemerkki MECCANO. Sättent der sker uhed foransagt af (I) at monteringsinstruktionerne ikke er blevet overholdt, (II) at delene er blevet brugt til andre formål, end dem der er beskrevet i betjeningsvejledningen, (III) eller at delene er blevet beskadiget eller ændret, frastog MECCANO S.A. sig ethvert ansvar for dette.

NL : Veel modellen en onderdelen zijn originele ontwerpen en eigendom van MECCANO S.A. en worden beschermd door de nationale wetgevingen op tekeningen en modellen, merken en/of auteursrechten. Voor informatie gelieve contact op te nemen met MECCANO S.A. De verantwoordelijkheid van MECCANO S.A. is uitgesloten in geval van origineel voorkomend uit het niet naleven van de montage-instructies (I), uit het gebruik van andere onderdelen dan die zoals vermeld in de handleiding (II) of uit het veranderen of modificeren van de onderdelen (III).

GR : Πολλά μοντέλα και ανταλλακτικά είναι αυθεντικά, ιδιοκτησία της MECCANO S.A. και προστατεύονται από τις ελληνικές νομοθεσίες για τα σχέδια της αρακής ή τα δικαιώματα πνευματικής ιδιοκτησίας, τις εμπορικές σήματα και/ή δικαιώματα πνευματικής ιδιοκτησίας. Για κάθε πληροφορία παρακαλούμε επικοινωνήστε με τη MECCANO S.A. Η εταιρεία της MECCANO S.A. δεν διαλαμβάνει καμία ευθύνη για τυχόν ατυχήματα (I) αν μη τηρήσει τις οδηγίες συναρμολόγησης (II) αν χρησιμοποιήσει διαφορετικές από αυτές που αναφέρονται στις οδηγίες (III) αν τροποποιήσει ή αλλάξει τον κατασκευαστή.

JPN : 本製品の各部分の図面は、その多くがMECCANO社所有のオリジナル・デザインとして、登録・商標および/または著作権に関する国内法によって保護されています。詳細については、当社のMECCANO S.A.へお問い合わせください。本製品の任意の部品を他の部品で交換し、同時に取扱説明書に記載された以外の部品を使用した場合、同製品を改造・改造した場合は上記記載の事項については責任を負うことはできません。

USA : Many models and component parts incorporate original designs which are the property of MECCANO S.A. and are protected as design and/or utility patent and/or copyrights. For detailed information, please contact MECCANO S.A. Instruction booklets are solely to assist in construction of sets. MECCANO S.A. shall have no responsibility for:
1. Failure to follow instructions.
2. Use of parts for any purpose other than as specified in the instruction booklets.
3. Any alteration of any parts or components.

Made in France by
Fabrique France par
Hecho en Francia
MECCANO S.A. MECCANO® is an exclusive trademark of MECCANO S.A.
© 1998 Meccano S.A.



MECCANO
363, Avenue de Saint-Exupéry
F - 62100 CALAIS