

1

- 1** x1
- x2
- x4
- | 5,8 mm | 15/64" | x4

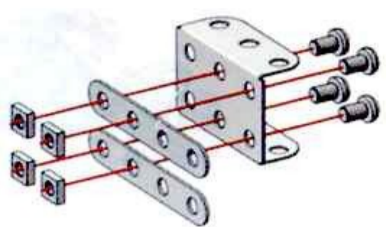

- 2** x1
- x1
- | 12 mm | 1/2" | x1

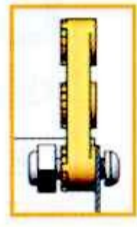
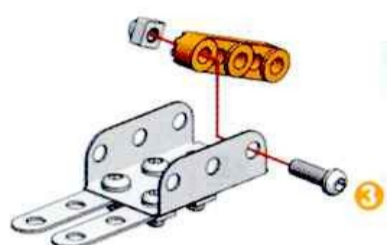

- 3** x1
- x2
- x2
- | 5,8 mm | 15/64" | x2

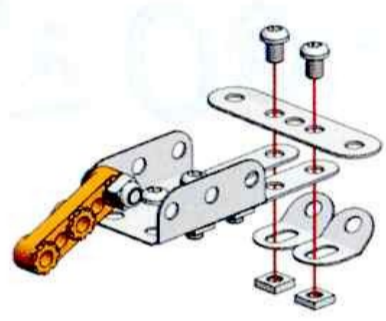

- 4** x1
- x1
- x2

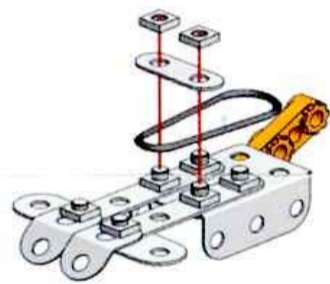

- 5** x2
- x2
- | 5,8 mm | 15/64" | x2

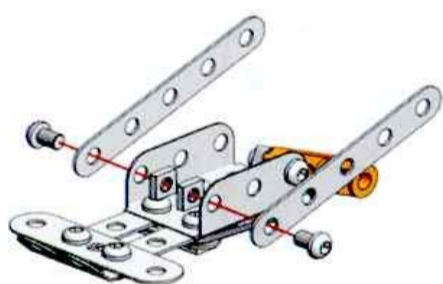

- 6** x1
- x2
- | 5,8 mm | 15/64" | x2

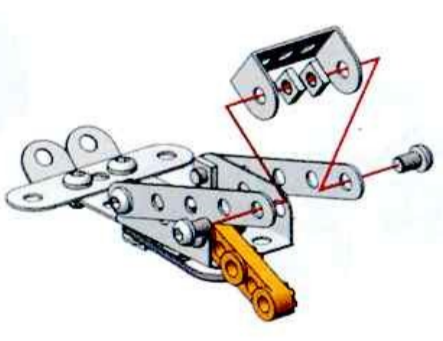



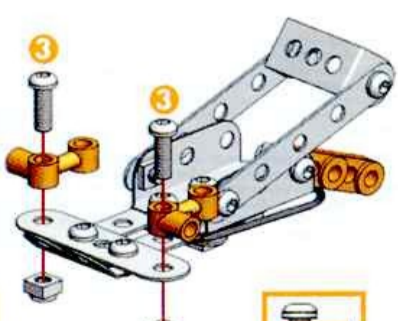

- 7** x2
- x2
- | 12 mm | 1/2" | x2

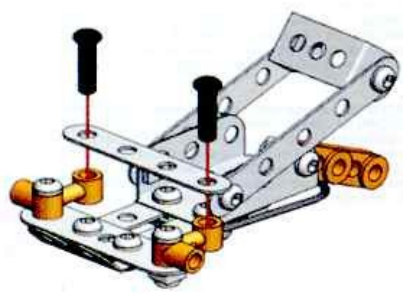



- 8** x1
- x2



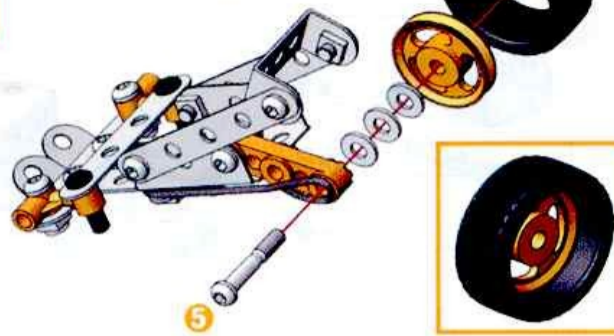
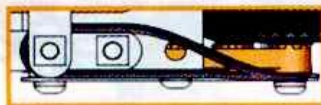

- 9**
-  **x1**
  -  **x1**
  -  **x3**
  -  **x1**
  -  **x1**



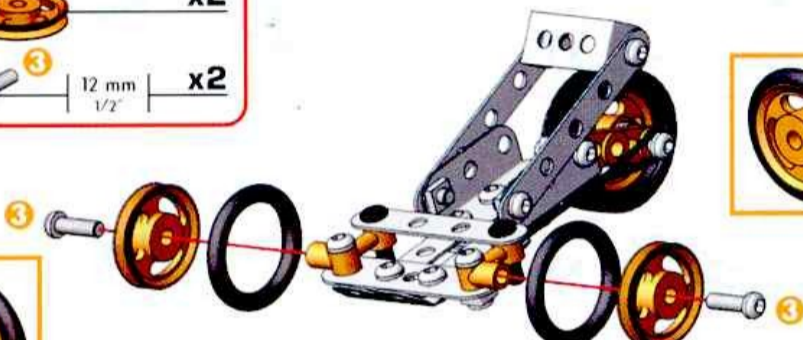

- 10**
-  **x2**
  -  **x2**
  -  **x2**

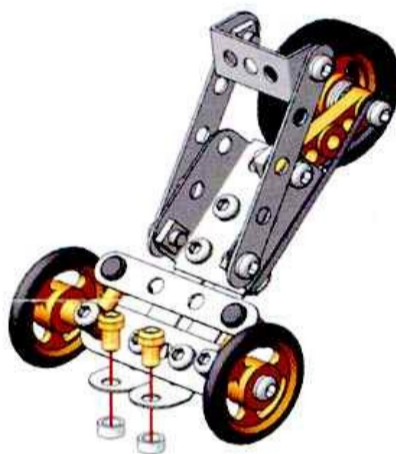

- 11**
-  **x2**
  -  **x2**

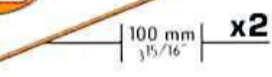

- 12**
-  **x2**
  -  **x2**
  -  **x2**

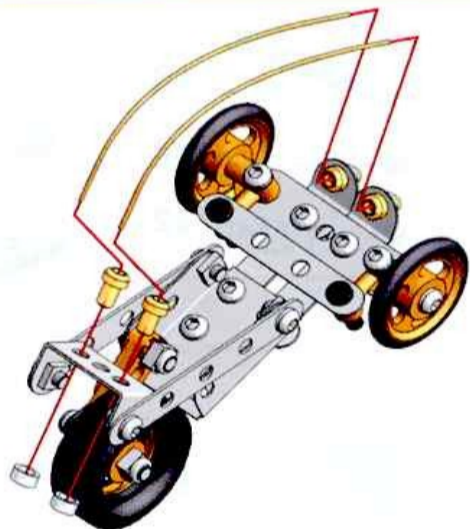
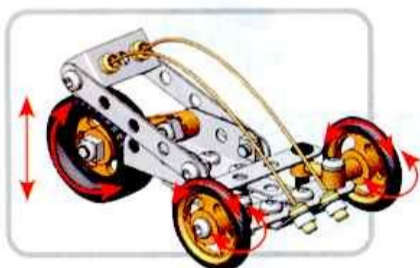

**GB** Many of the models and component parts are unique and original designs which are the property of MECCANO S.A. They are protected by national legislation as industrial designs, trademarks and/or copyrights throughout many countries. For detailed information, please contact MECCANO S.A. MECCANO S.A. accepts no responsibility for (i) failure to follow instructions, (ii) use for any purpose other than as specified in the instructions (iii) any alteration of any parts or components.

**F** De nombreux modèles et pièces sont des créations originales, propriétés de MECCANO S.A. et sont protégés par les législations nationales sur les dessins et modèles, marques et/ou droits d'auteurs. Pour toute information, merci de contacter MECCANO S.A. La responsabilité de MECCANO S.A. ne saurait être engagée en cas d'accident survenu à la suite (i) du non respect des instructions de montage (ii) d'une utilisation des pièces autre que celle proposée dans la notice (iii) d'une altération ou de la modification des pièces.

**D** Zahlreiche Modelle und Teile sind Erfindungen und Eigentum der Firma MECCANO S.A. Sie sind durch Inland-Gesetze über Zeichnungen und Modelle sowie Warenzeichen und/oder Urheberrechte geschützt. Für zusätzliche Auskünfte wenden Sie sich bitte an: MECCANO S.A. Die Firma MECCANO S.A. haftet nicht für Unfälle, die aus der (i) Nichtbeachtung der Bauanleitung, der (ii) Verwendung anderer als in der Bauanleitung angegebenen Teile oder der (iii) Änderung oder Modifikation der Teile resultieren.

**I** Numerosi modelli e pezzi sono creazioni originali della MECCANO S.A. e sono protetti dalle legislazioni nazionali sui disegni e modelli, marchi e/o diritti d'autore. Per qualsiasi informazione, viaggiate contatto con: MECCANO S.A. MECCANO S.A. declina ogni responsabilità in caso d'incidenti sopravvenuti in seguito a: (i) non rispetto delle istruzioni di montaggio (ii) utilizzo dei pezzi per funzioni diverse da quelle previste nel manuale (iii) alterazione e/o modifica dei pezzi.

**E** Numerosos modelos y piezas son creaciones originales, propiedades de MECCANO S.A. y están protegidos por las legislaciones nacionales en lo que concierne a los dibujos y modelos, marcas y/o derechos de autor. Para cualquier información, sinvase ponerse en contacto con: MECCANO S.A. MECCANO S.A. carece de responsabilidad en caso de accidente debido a (i) el incumplimiento de las instrucciones de montaje (ii) una utilización de las piezas diferente a la que se indica en las instrucciones (iii) una alteración o modificación de las piezas.

**P** Vários modelos e peças são criações originais, propriedades da MECCANO S.A. e são protegidos pelas legislações nacionais relativas aos desenhos e modelos, às marcas e/ou aos direitos de autor. Para qualquer informação, é favor contactar: MECCANO S.A. A Sociedade MECCANO S.A. não poderá ser responsabilizada pelos acidentes provocados: (i) pela falta de cumprimento das instruções de montagem (ii) pelo uso indevido das peças ou (iii) pela modificação ou alteração das peças.

**S** Många modeller och delar bärar en unik och original formgivning vilken är MECCANO S.A. egendom. Dessa modeller och delar är skyddade genom lagstiftning såsom industriella formgivning, varumärke och/eller upphovsrättigheter i ett flertal länder. För mer detaljerad information, var vänlig och kontakta MECCANO S.A. MECCANO S.A. åtar sig allt ansvar i händelse av olycka till följd av (i) att monteringsinstruktionerna inte har respekterats (ii) en annan användning av delarna än den som står i anvisningen (iii) en förändring eller förändring av delarna.

**FIN** Vore mange modeller og dele er originale fremstillinger og ejes af MECCANO S.A. Tegninger, modeller, fabrikmærker og ophavsret er lovbeskyttede i hvert land. Yderligere oplysninger kan fås hos MECCANO S.A. MECCANO S.A. er vastaa ei kata seuravasta systä satuneita onnettomuuksia: (1) ohjeiden vastainen kokaaminen, (2) muuten kuin ohjeissa ehdotettujen osien käyttö, (3) osien vaurio tai muuttelu.

**DK** Ubest møllt ja osat ovat MECCANO S.A.'n omisuutta olevia suurimkkeitä. Ubest møllt ja mden osat ovat lalla suojattu teollista mustollia, tavaramerkkejä jattai kopiointioikeuksia useissa maissa. Tuclermerkki MECCANO S.A. Sährent der sker uheld forårsaget af (i) at monterings instruktionerne ikke er blevet overholdt, (ii) at delene er blevet brugt til andre formål, end dem der er beskrevet i betjeningsvejledningen, (iii) eller at delene er blevet beskadiget eller ændret, traeger MECCANO S.A. sig ethvert ansvar for dette.

**NL** Veel modellen en onderdelen zijn originele ontwerpen en eigendom van MECCANO S.A., en worden beschermd door de nationale wetgevingen op tekeningen en modellen, merken en/of auteursrechten. Voor informatie gelieve contact op te nemen met MECCANO S.A. De verantwoordelijkheid van MECCANO S.A. is uitgesloten in geval van ongevallen voortvloeiend uit het niet naleven van de montage-instructies (i), uit het gebruik van andere onderdelen dan die zoals vermeld in de handleiding (ii) of uit het veranderen of modificeren van de onderdelen (iii).

**GR** Πολλά μοντέλα και ανταλλακτικά είναι πρωτότυπα, ιδιοκτησία της MECCANO S.A. και προστατεύονται από τις εθνικές νομοθεσίες για τα σχέδια και τα πρότυπα και/ή δικαιώματα πνευματικής ιδιοκτησίας. Για κάθε πληροφορία επικοινωνήστε με τη MECCANO S.A. Η εταιρεία MECCANO S.A. δεν δεχεται καμία ευθύνη για ατυχήματα που συμβαίνουν λόγω (i) μη συμμόρφωσης με τις οδηγίες συναρμολόγησης (ii) χρήσης των ανταλλακτικών MECCANO S.A. για άλλους σκοπούς ή (iii) αλλαγών ή τροποποιήσεων των ανταλλακτικών.

**JPN** モデルや部品は、その多くが MECCANO S.A. 所有のオリジナルデザインです。設計、商標、特許、またはその他の権利は、国や地域によって保護されています。詳細については、当社 (MECCANO S.A.) までお問い合わせください。事故の原因となった場合、(i) 使用説明書に記載されたものの以外の部品を使用した場合、(ii) 部品を改造・改造した場などから起きた事故については責任を負うことはできません。

**USA** Many models and component parts incorporate original designs which are the property of MECCANO S.A. and are protected as design and/or utility patent and/or copyrights. For detailed information, please contact MECCANO S.A. Instruction booklets are solely to assist in construction of sets. MECCANO S.A. shall have no responsibility for:  
1. Failure to follow instructions.  
2. Use of parts for any purpose other than as specified in the instruction booklets.  
3. Any alteration of any parts or components.

Made in France by  
Fabrique en France par  
Hecho en Francia

MECCANO S.A. MECCANO is an exclusive trademark of MECCANO S.A.  
© 10/1998 Meccano S.A.



**MECCANO**  
363, Avenue de Saint-Exupéry  
F - 62100 CALAIS