

Instructions
Notice de montage
Bauanleitung
istruzioni di montaggio
Instrucciones de montaje
Instruções de montagem

Monteringsanvisning
Kokoamisohje
Monterings instruktioner
Montagehandleiding
Οδηγίες συναρμολόγησης.
組立説明書

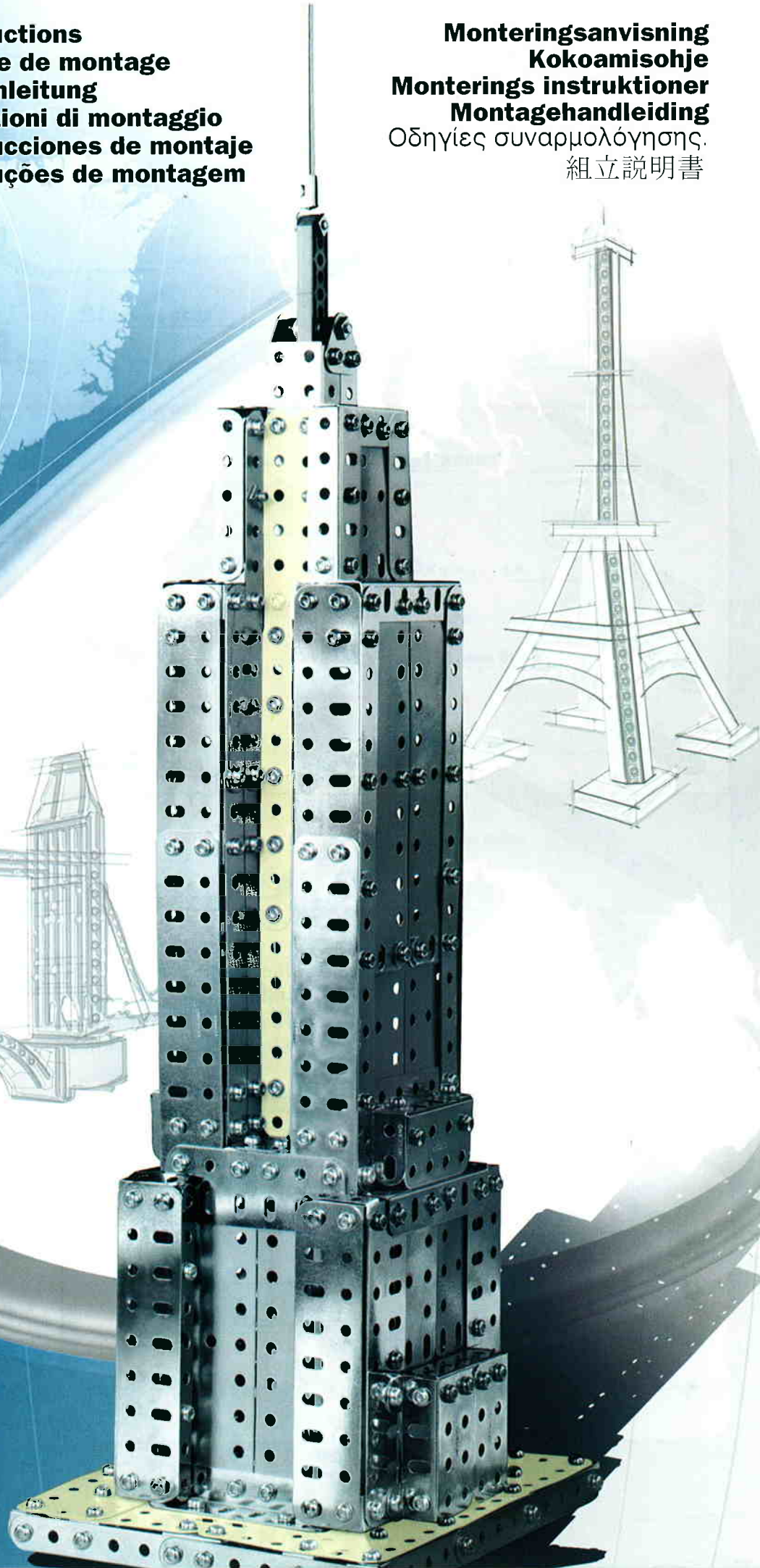

8+



A202 (0002) x12



A415 (0235D) x4



A302 (0002A) x12



B482 x12



A203 (0003) x4



A304 (0004) x12



B146 (0006) x2



A303 (0103) x4



A297 (0103C) x12



A299 (0103E) x4



A522 (0189) x8



A520 (0188) x12



A520 (0188) x10



A604 (0009C) x6



A602 (0009D) x4



A603 (0009E) x4



A455 (0161) x6



A252 (0051A) x2



A612 (0012A) x20



A812 (0812B) x4



A512 (0012B) x4



A548 (0048E) x4



A012 (0012) x48



A309 (0009L) x4



A277 (0077) x2



A503 (0103L) x2



A016 (0016B) x1



B051 x1

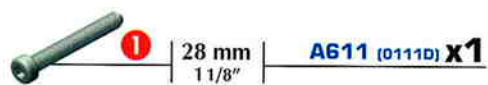

A611 (0111D) x1

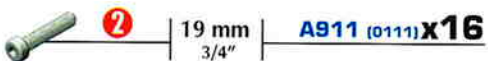

A911 (0111) x16

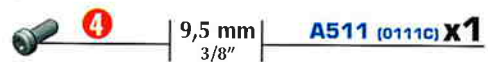

A511 (0111C) x1



A637 (0037B) x312



A238 (0038A) x26



A138 (0038) x52



A337 (0037A) x330



A212 (0212) x1



A134 (0034) x1



A136 (0036C) x1

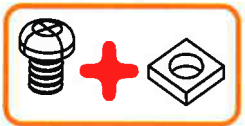
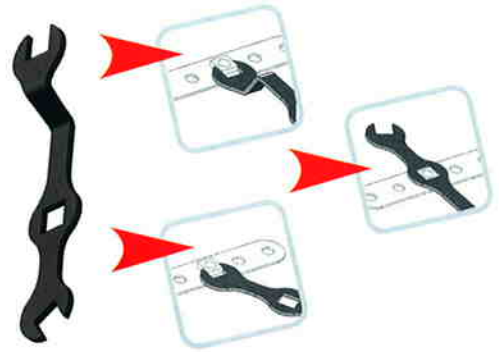
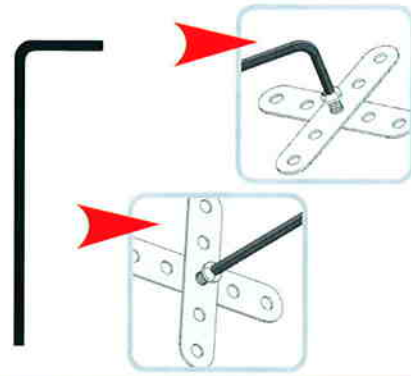
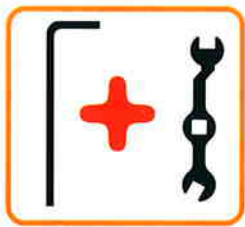

1



2



3



28 mm
1 1/8"



1

19 mm
3/4"

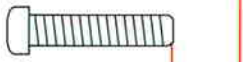

2

9,5 mm
3/8"



4

5,8 mm
15/64"



Scale
Echelle
Maßstab
Scala

Escala
Schaal
Escala
Skala

Mittakaava
Målestok
Κλίμακα
スケール

1:1



Cm



Inches





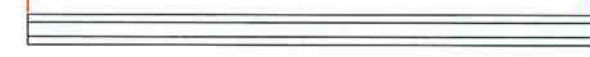

75 mm
3"





1

-  x4
-  x4
-  x2
-  5,8 mm 15/64" x6
-  x6

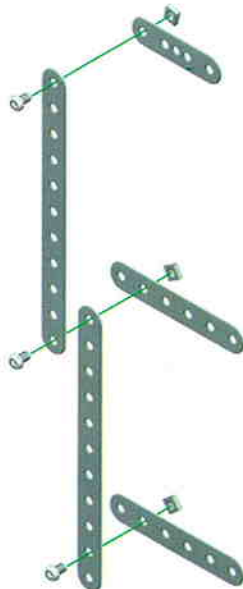

x2=

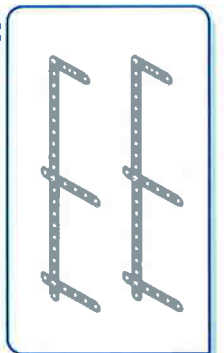

4

2

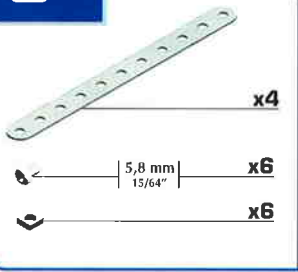

3

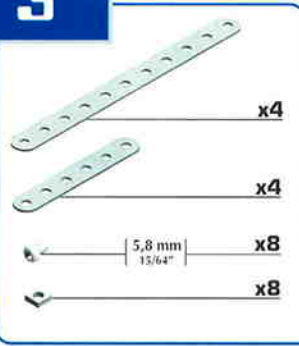

x2=

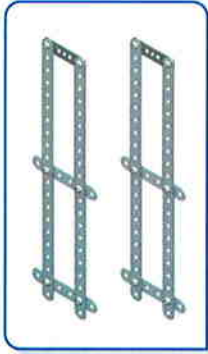
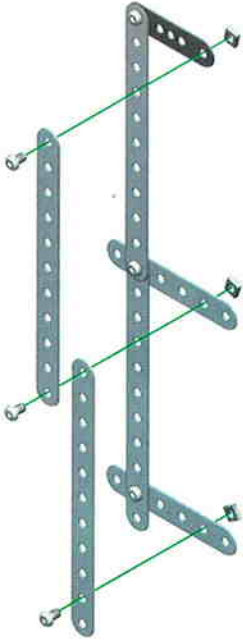

x2=

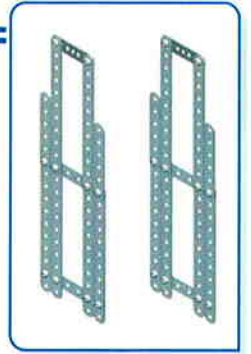
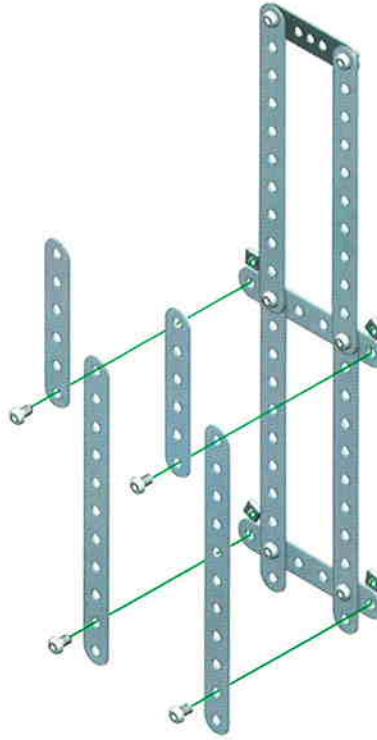

4

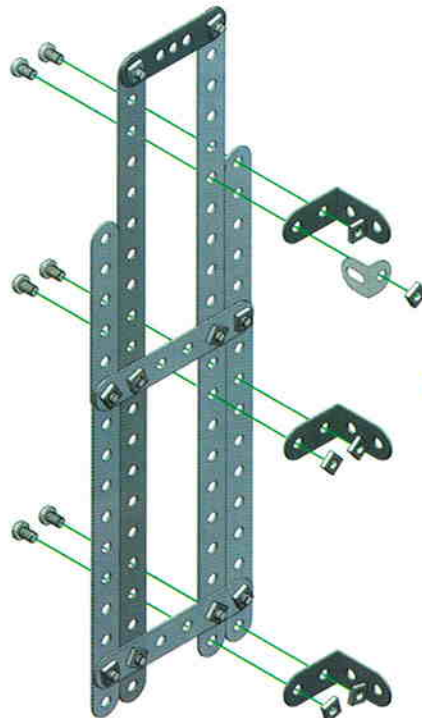
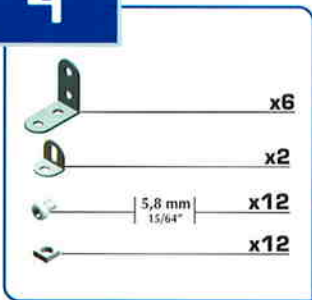



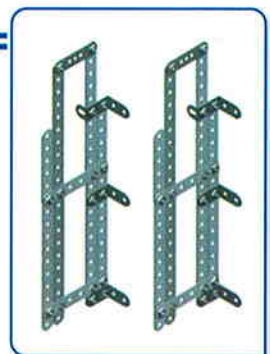

x2=







5





5

-  x6
-  x2
-  x12
-  x12

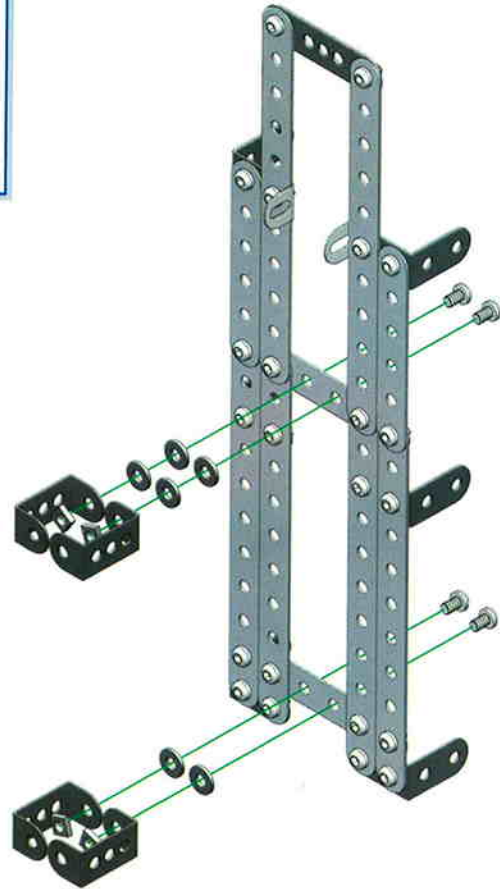
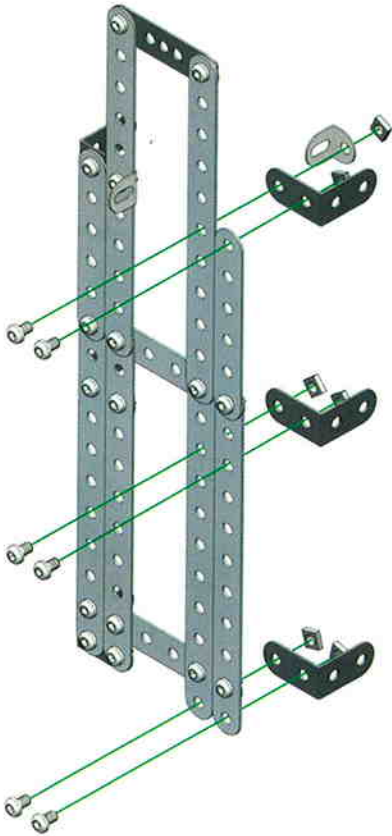
6



-  x4
-  x6
-  x4
-  x4

x2=**7**

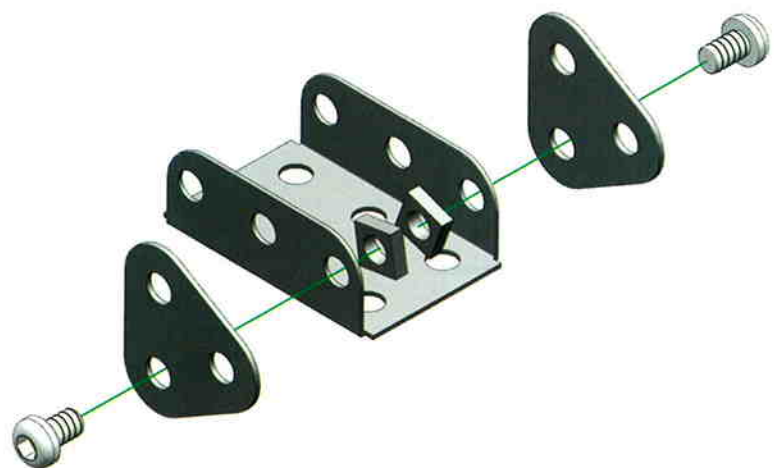
-  x1
-  x2
-  x2
-  x2



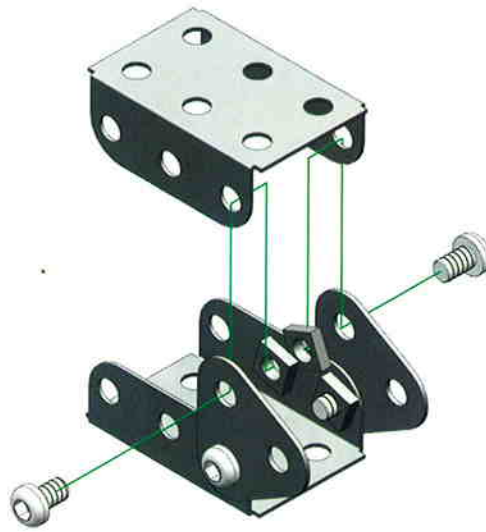

**6**

8 **7+**

-  x1
-  x2
-  x2



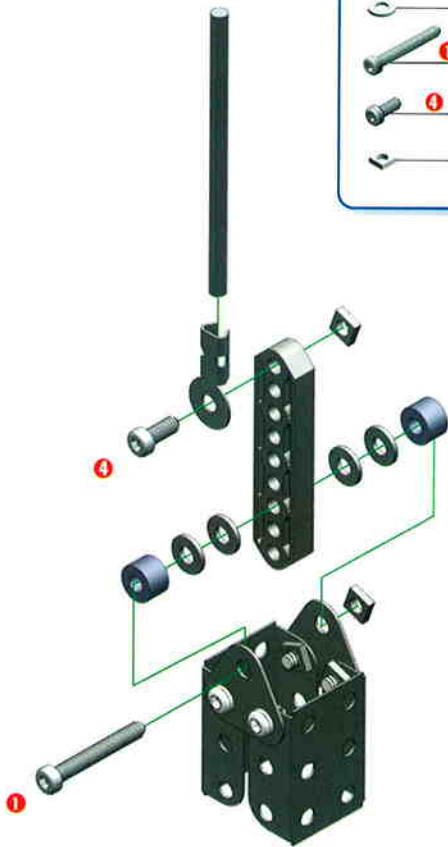
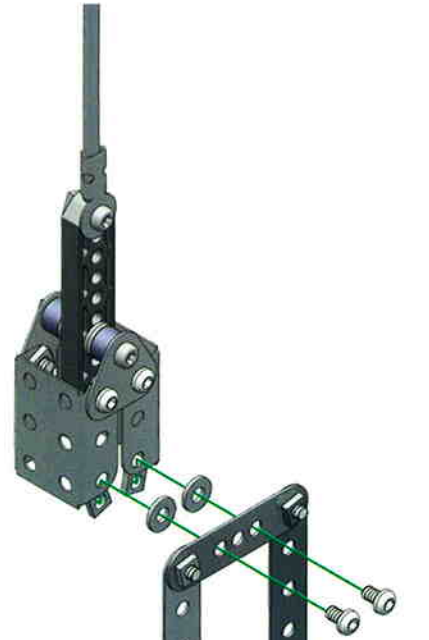

9

-  x1
-  x1
-  x1
-  x2
-  x4
-  **1** x1
-  **1** x1
-  x2





10 **6+** **9+**

-  x2
-  x2
-  x2



11**5 + 10 +**

-  **x8**
-  **x6**
-  **x6**

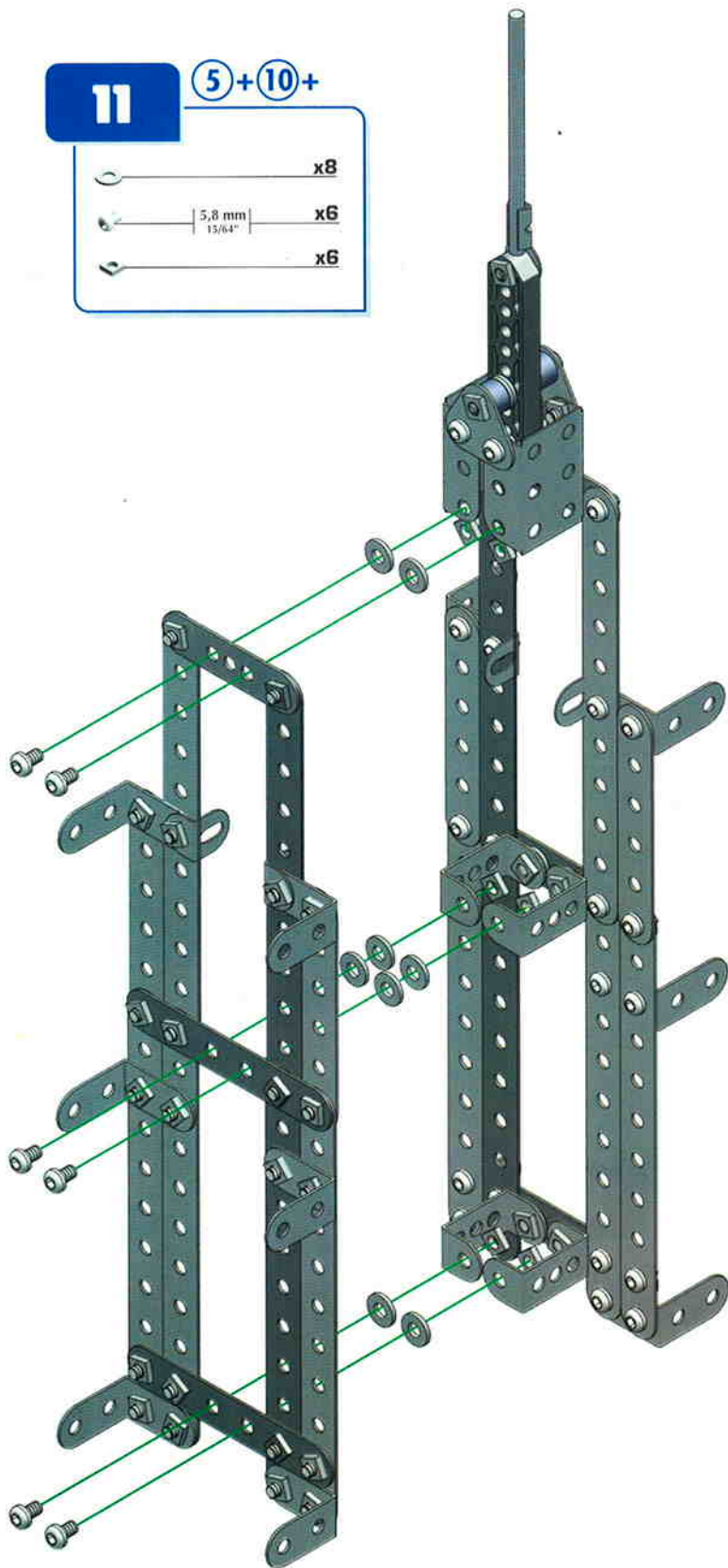
**12**

-  **x12**
-  **x16**
-  **x16**

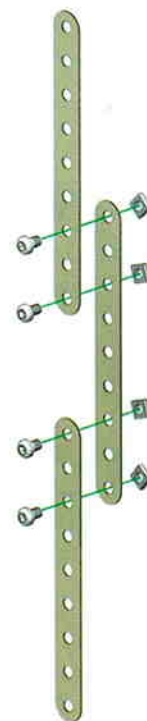
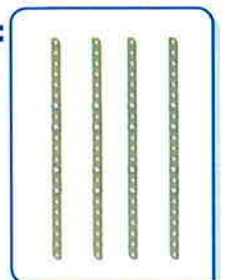
x4=

13

⑪ + ⑫ +

5,8 mm
15/64" x8
x8

14

⑫ + ⑬ +

5,8 mm
15/64" x8
x8

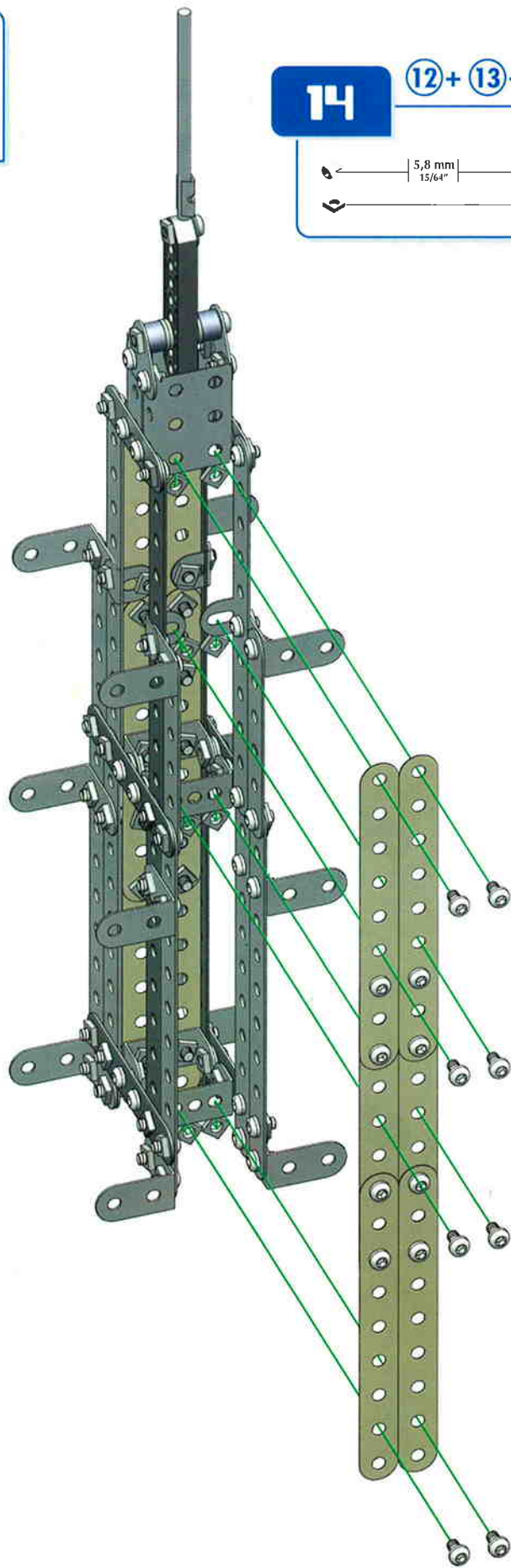
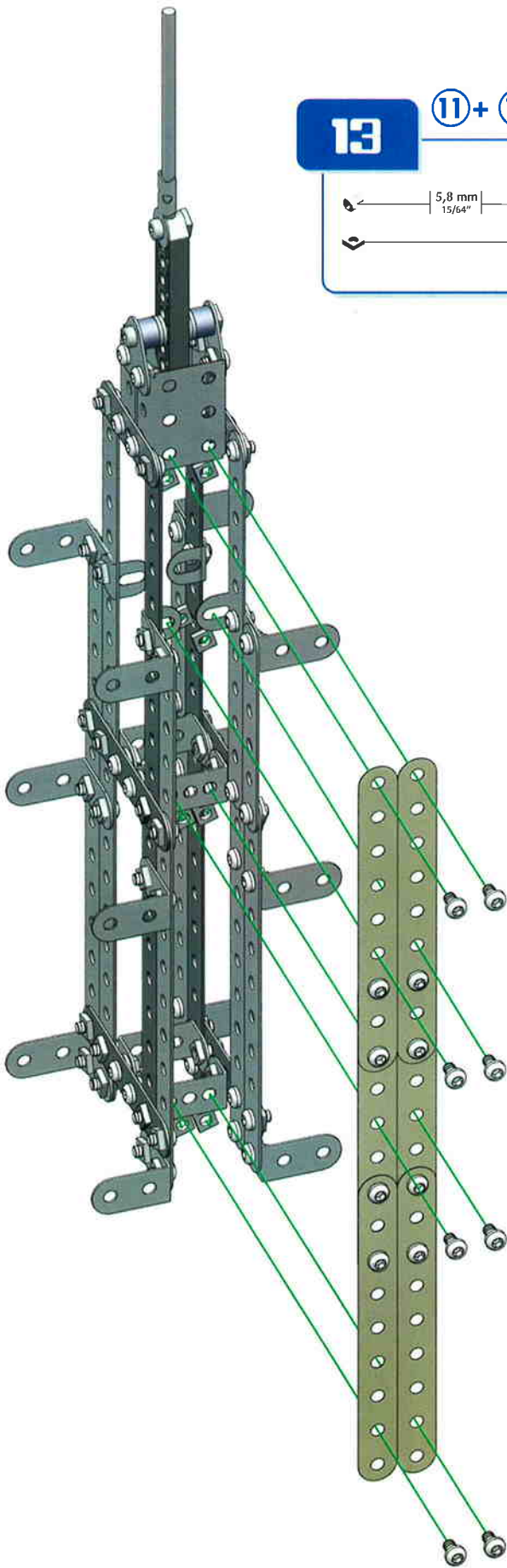

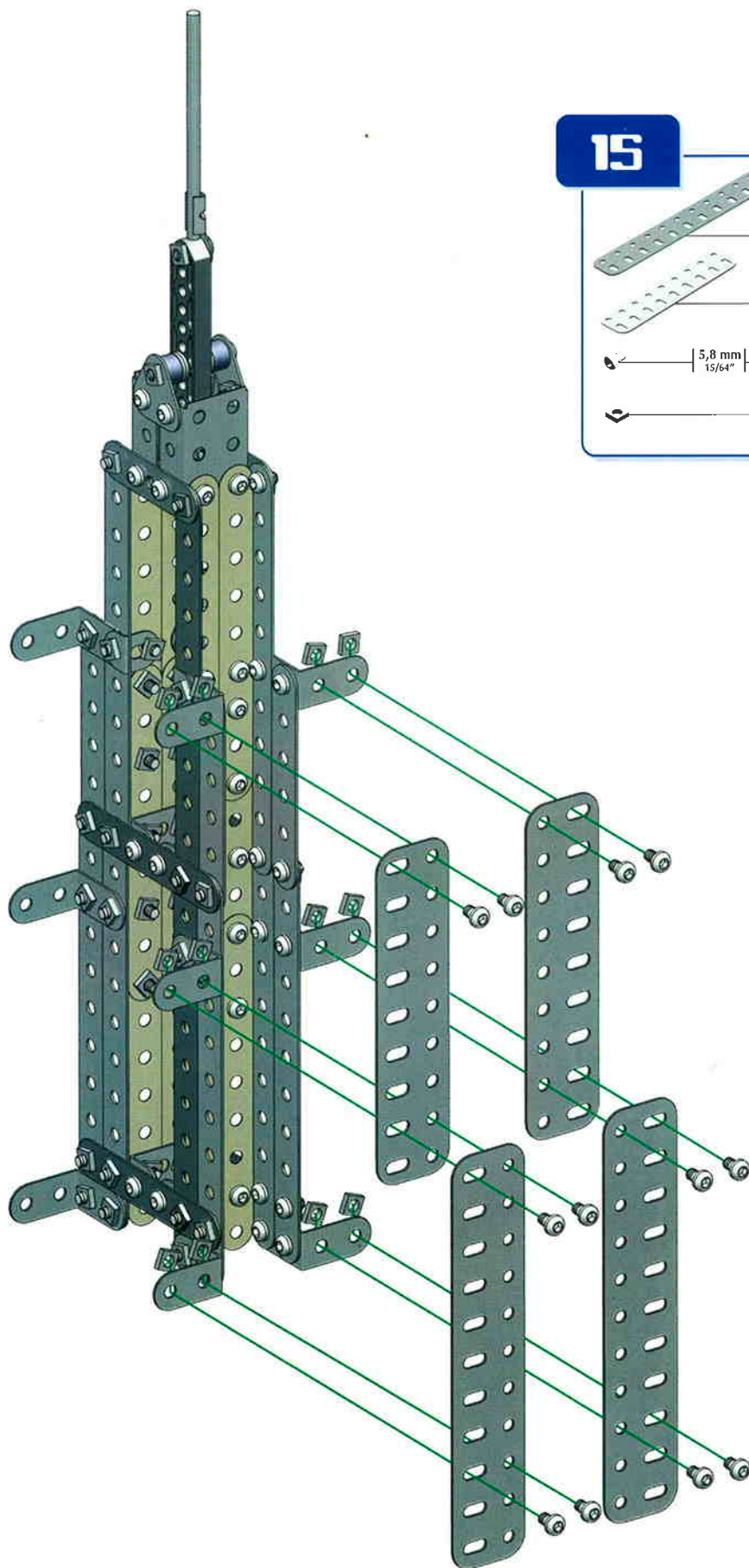
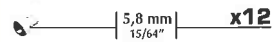
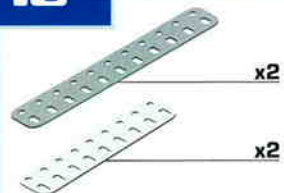

15

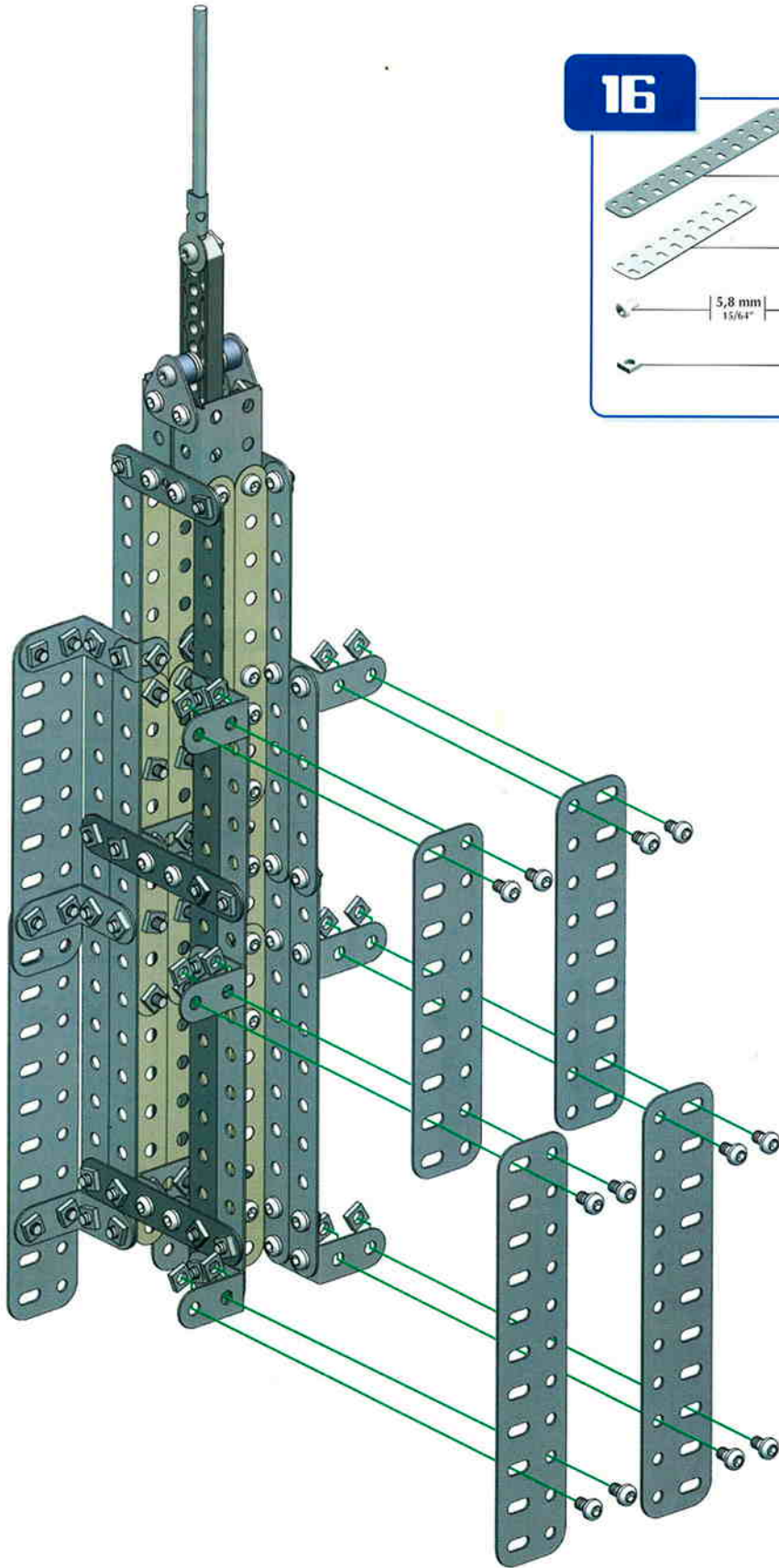



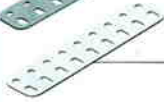



16

-  x2
-  x2
-  x12
-  x12

17

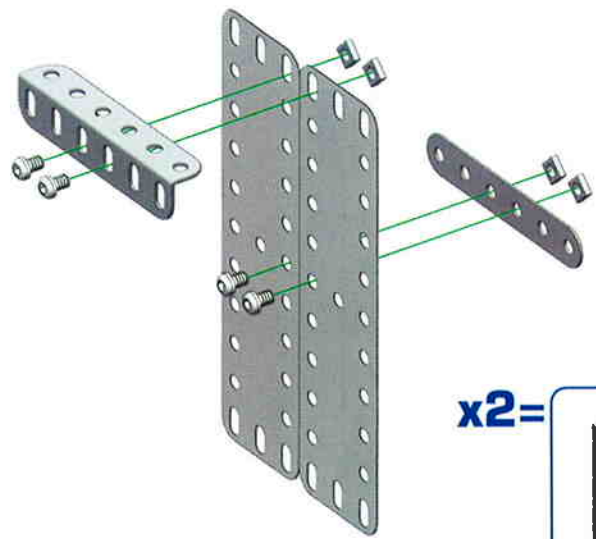

-  x4
-  x2
-  x2
-  x8
-  x8

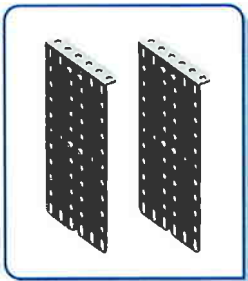

x2=





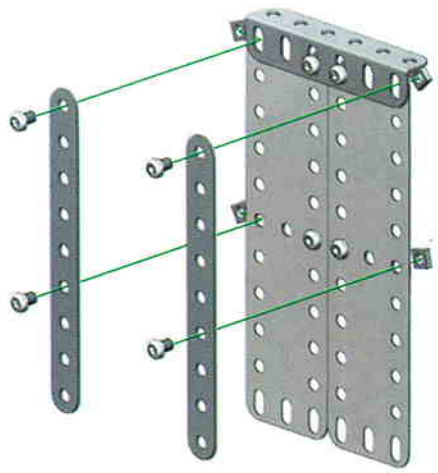

18

-  x4
-  x8
-  x8

x2=



19

-  x4
-  x4
-  x8
-  x8

x2=

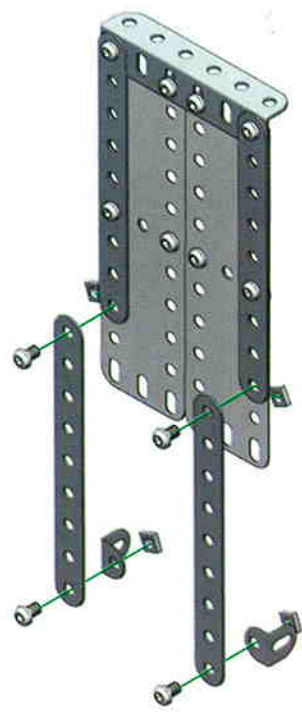

12