

Instructions

Notice de montage

Bauanleitung

Istruzioni di montaggio

Instrucciones de montaje

Instruções de montagem

Monteringsanvisning

Kokoamisohje

Monterings instruktioner

Montagehandleiding

Οδηγίες συναρμολόγησης.

組立説明書





- Ⓒ The battery housing and the motor shown in the instructions have been replaced.
- Ⓕ Le boîtier de piles et le moteur présentés dans la notice ont été remplacés.
- Ⓖ Das in der Gebrauchsanweisung gezeigte Batteriegehäuse sowie der Motor wurden ersetzt.
- Ⓘ Il vano pile ed il motore presentati nelle istruzioni per l'uso sono stati sostituiti.
- Ⓔ La caja de pilas y el motor presentados en las instrucciones han sido sustituidos.
- ⒫ O compartimento de pilhas e o motor apresentados nas instruções foram substituídos.
- Ⓒ Batterilådan och motorn som presenteras i notisen har ersatts.
- Ⓕ Ohjekirjassa esitetyt paristokotero ja moottori on vaihdettu.
- Ⓖ Batteridåsen og motoren, som er vist i vejledningen, er blevet udskiftet.
- Ⓖ Het batterijcompartiment en de motor uit de handleiding zijn vervangen.
- Ⓖ Το πακέτο μπαταριών και το μοτέρ που παρουσιάζονται στις οδηγίες αντικαταστάθηκαν.
- Ⓖ モデル組立てを目録にするために、説明書内の電池ボックスとモータが新型になりました。

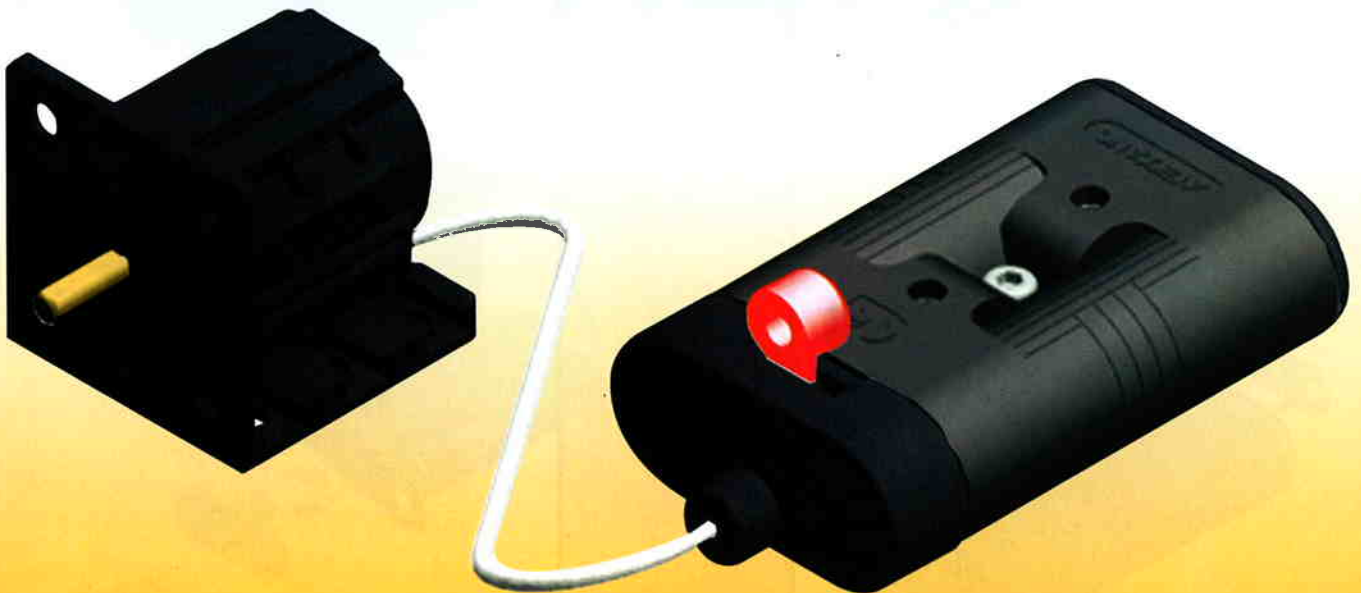
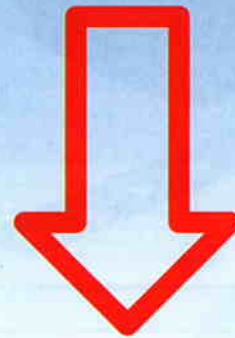
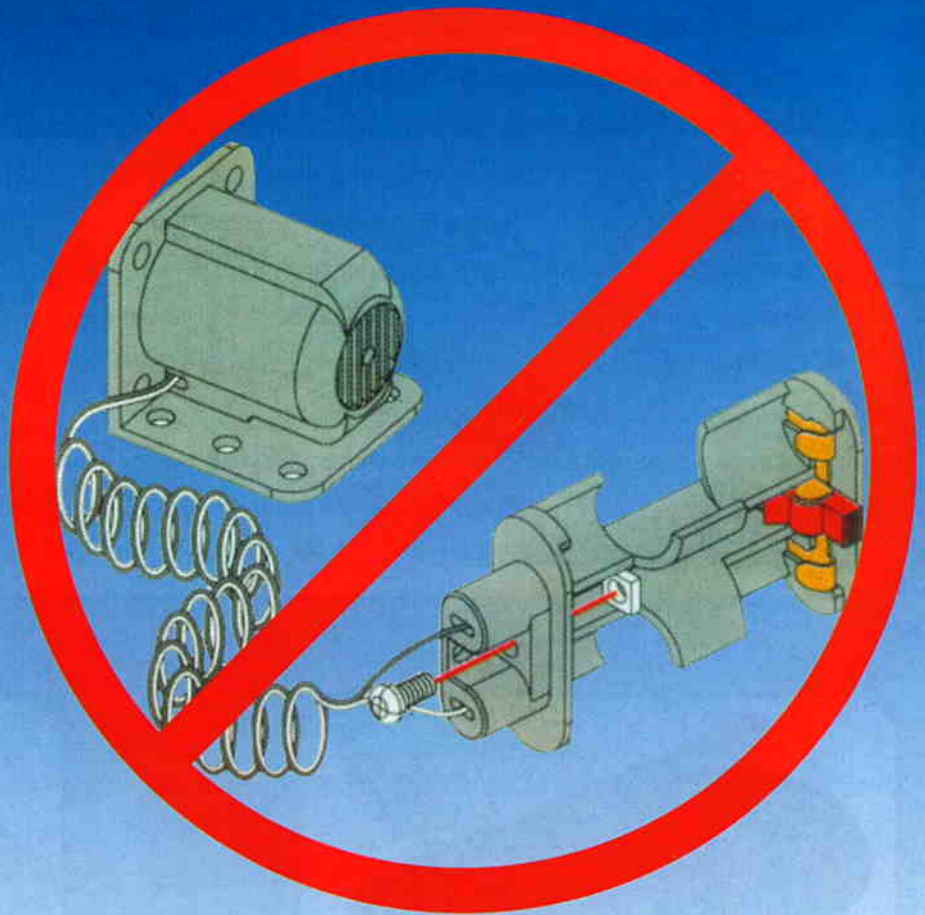

- ⓖⓑ Assembly examples of the new battery housing and the new motor.
- ⓕⓁ Exemples de montage du nouveau boîtier de piles et du nouveau moteur.
- ⓓⓂ Montagebeispiele mit dem neuen Batteriegehäuse und dem neuen Motor.
- ⓇⓂ Esempio di montaggio del nuovo vano pile e del nuovo motore.
- ⓔⓂ Ejemplos de montaje de la nueva caja de pilas y del nuevo motor.
- ⓅⓂ Exemplos de montagem do novo compartimento de pilhas e do novo motor.
- ⓈⓂ Exempel på montering av den nya batterilådan och den nya motorn.
- ⓕⓇⓂ Uuden paristolokeron ja uuden moottorin asennusesimerkki.
- ⓓⓀ Eksempler på montering af den nye batteridåse og den nye motor.
- ⓃⓁ Montagevoorbeelden van het nieuwe batterijcompartiment en de nieuwe motor.
- ⓖⓇ Παράδειγματα συναρμολόγησης του νέου πακέτου μπαταριών και του νέου μοτέρ.
- ⓙⓅ 新型電池ボックスと新型モータの組立て例

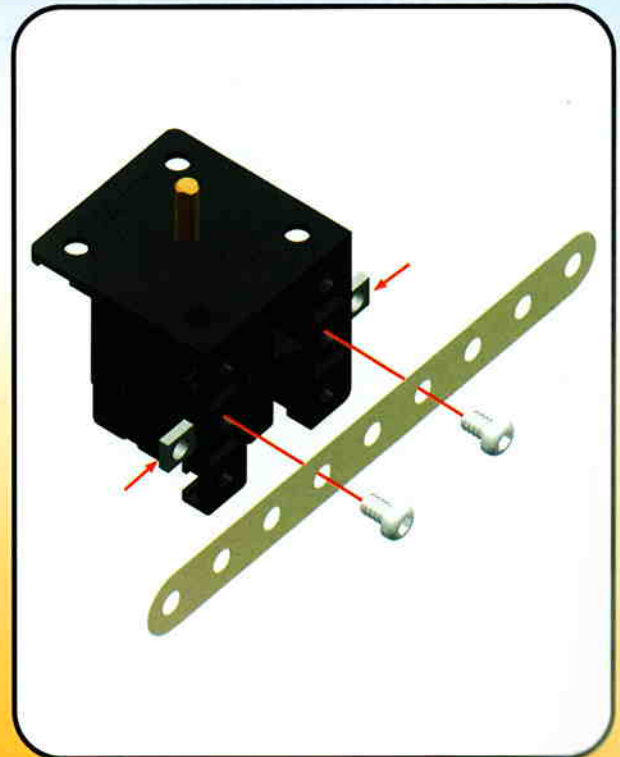
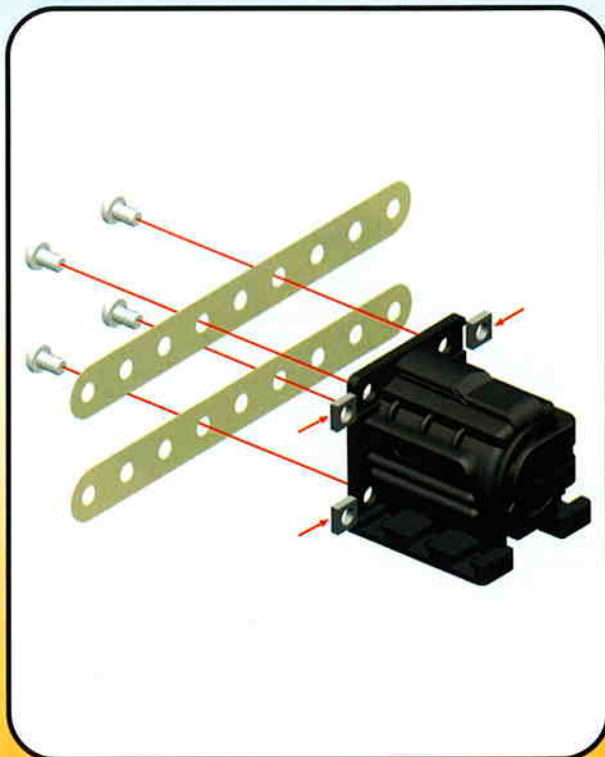
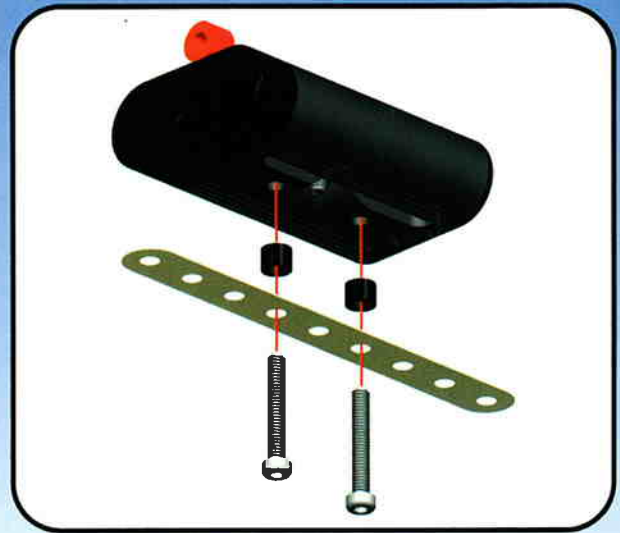
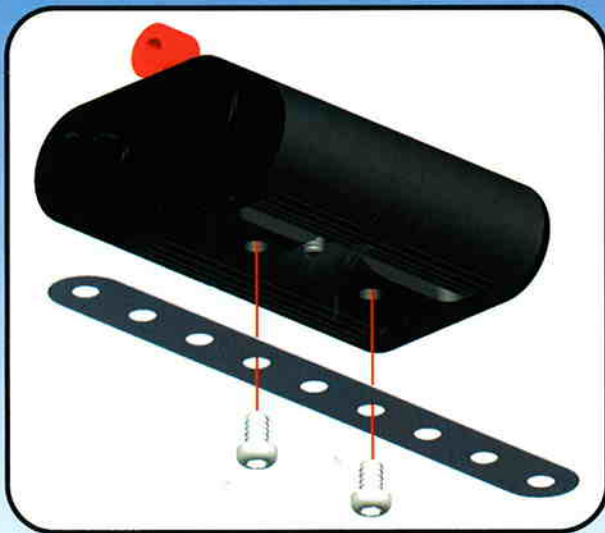

1



2



3



4



5

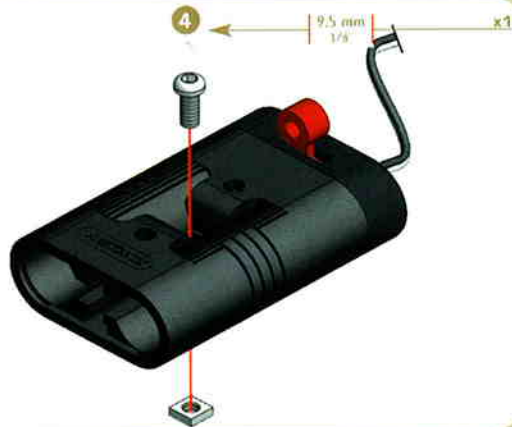

6



Use 2 AA batteries.
(not included).

7

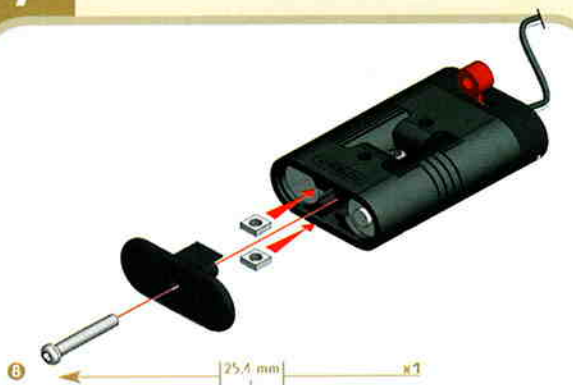

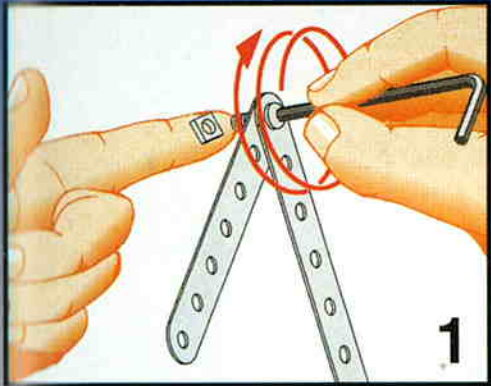

1

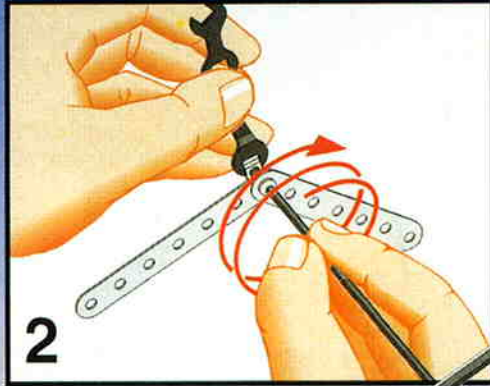

2

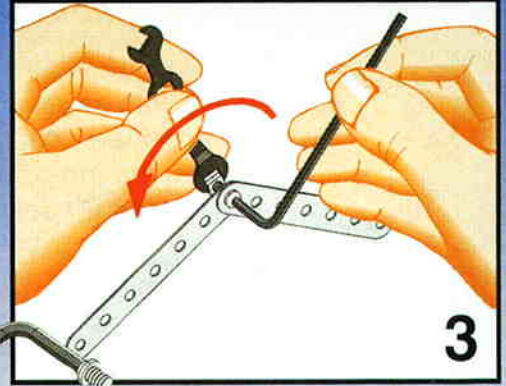

3

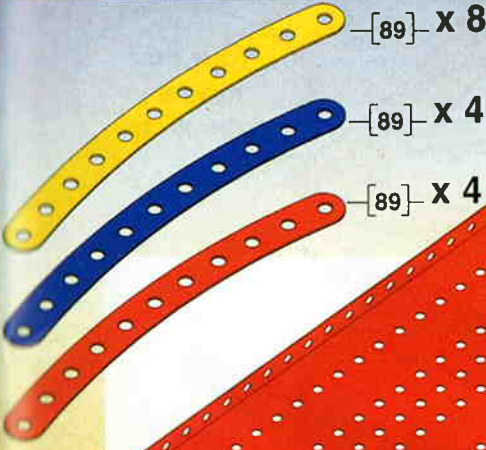
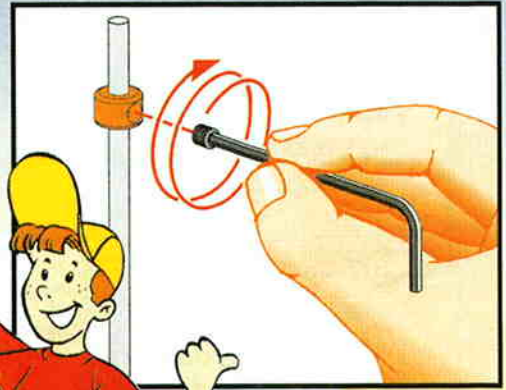

[89] x 8

[89] x 4

[89] x 4

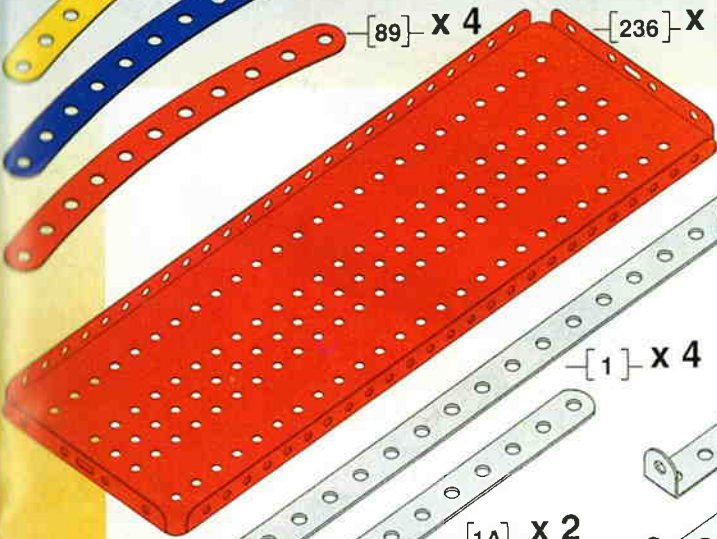

[236] x 1

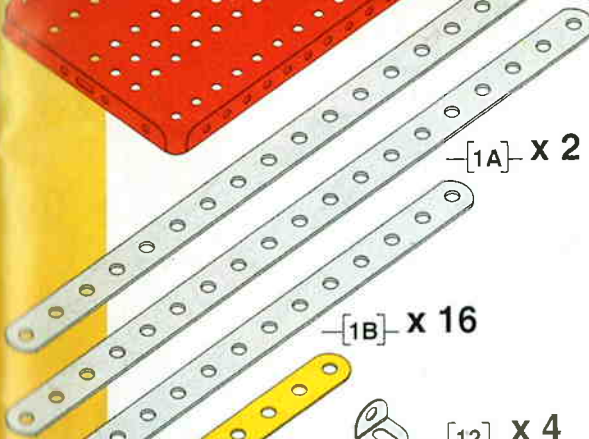

[1] x 4

[1A] x 2

[1B] x 16

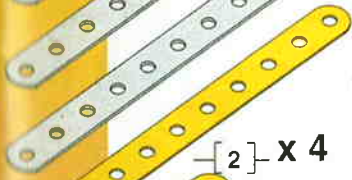

[2] x 4

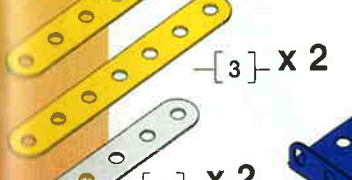

[3] x 2

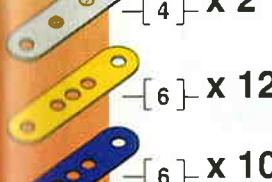

[4] x 2



[6] x 12

[6] x 10

[6] x 10



[77] x 2



[51] x 3

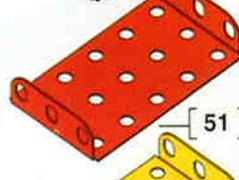

[51] x 3

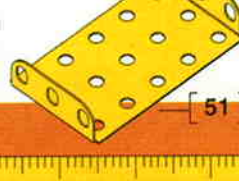

[51] x 2

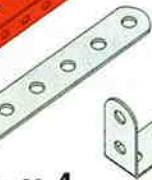

[46a] x 1

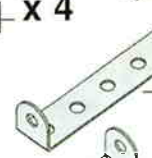

[48a] x 4



[48] x 1

- [2] 19, mm [111] x 2
- [3] 12, mm [111a] x 8
- [4] 9,5 mm [111c] x 3

[37b] x 120

[69a] x 3

[38] x 12

[37a] x 133

[23c] x 22

[38a] x 16



[27A] x 1

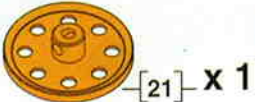

[21] x 1



[22] x 1

13,5 cm [15] x 1

9 cm 3/4" [16] x 8

6 cm 2 1/2" [16a] x 2

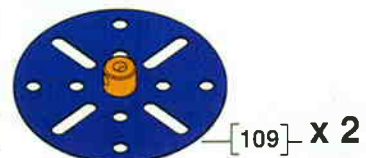

[109] x 2

[32] x 1

[32] x 1

[32] x 1



[720]

x 2

x 2

x 1

x 1

x 1

x 1

x 1

x 1

x 1

x 1

x 1

x 1

x 1

x 1

x 1

x 1

x 1

x 1

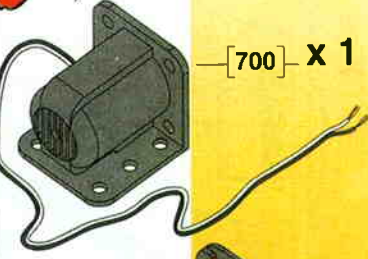
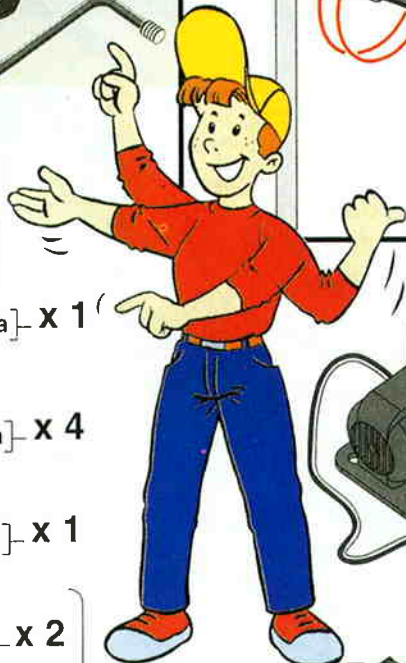

[700] x 1

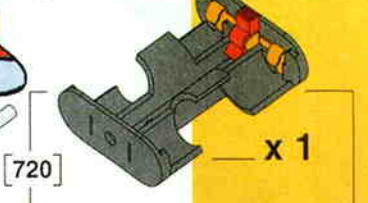

x 1

x 2

x 2

x 1

x 1

x 1

x 1

x 1

x 1

x 1

x 1

x 1

x 1

x 1

x 1

x 1

x 1

x 1

x 1



Discover the method of assembling with screws and nuts, the tools and their use, the set-up principles, the fun of building working models.

Follow the step by step assembly ; this progression will guide you and you will succeed in making the models.

Choose the necessary parts by following each step.

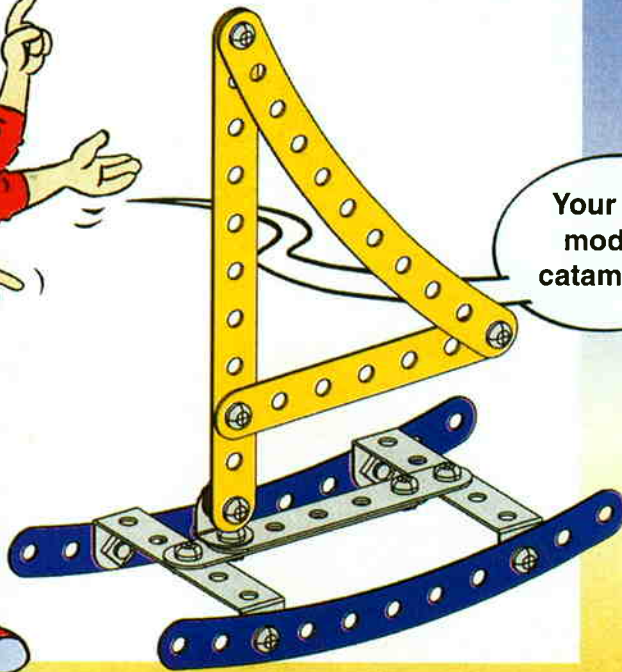

Your first model : catamaran.

1

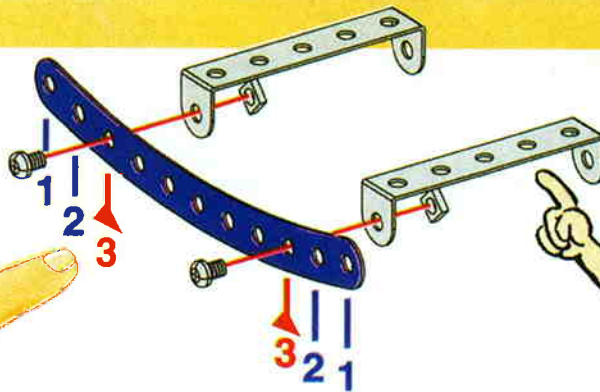
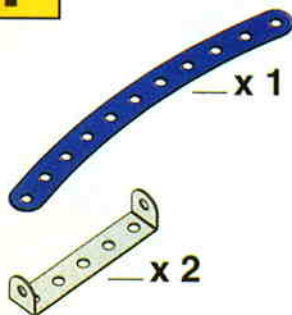

2

1+

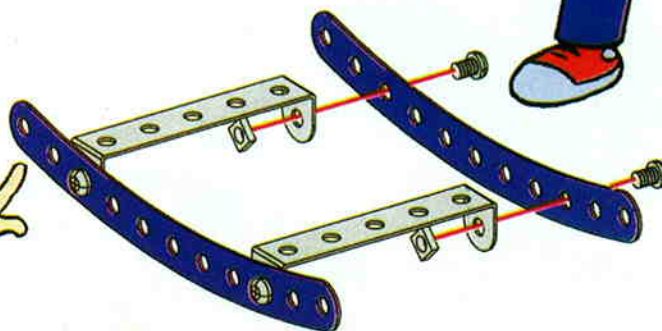
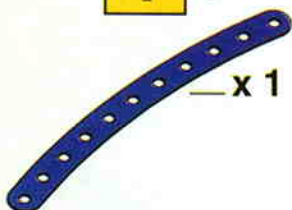

3

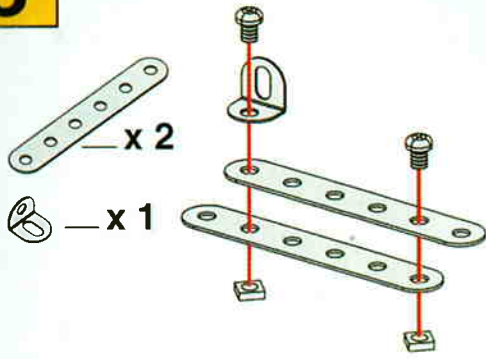

4

2 + 3

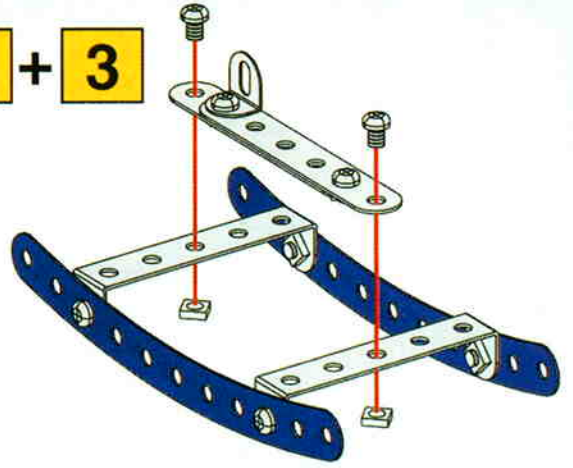

5

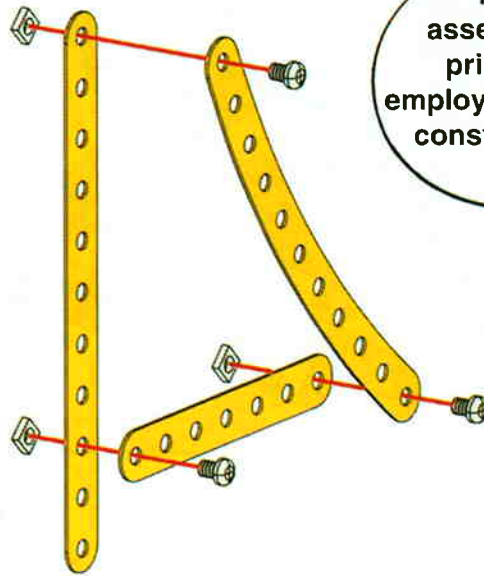
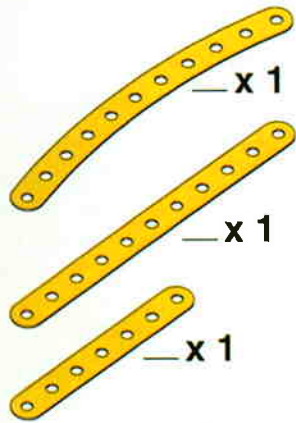

Rigid assemblies :
principles
employed for solid
constructions.

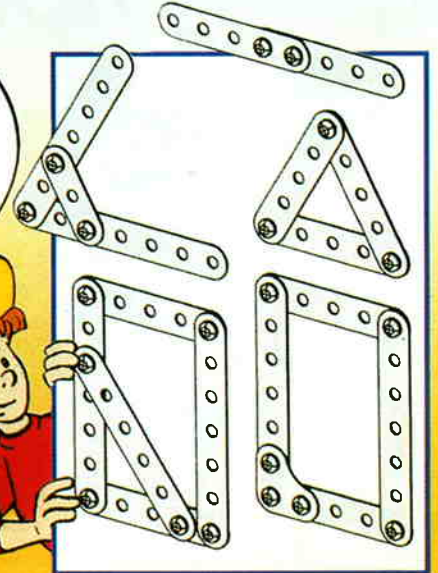

6

4 + 5 +

③ | 12 mm | x 1
● x 1

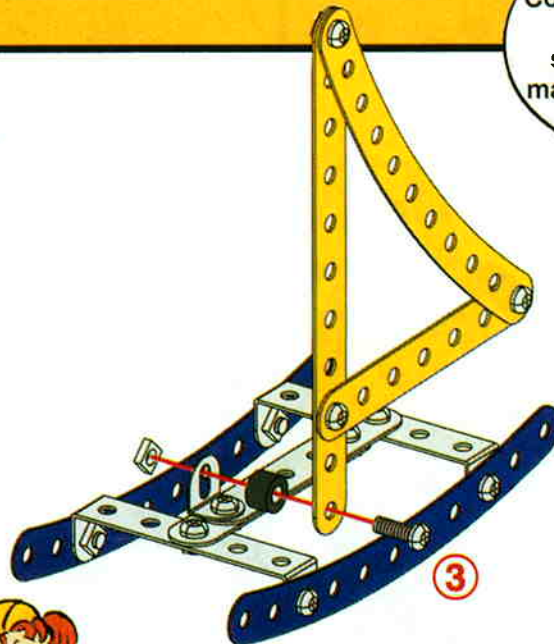

It works !
Congratulations !
You have
succeeded in
making your first
model !





1

