

2302

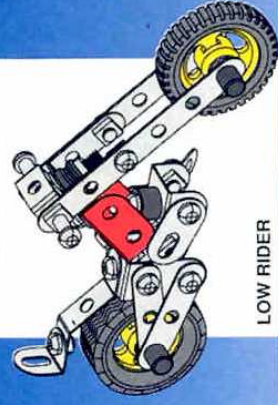

2302

LOW RIDER

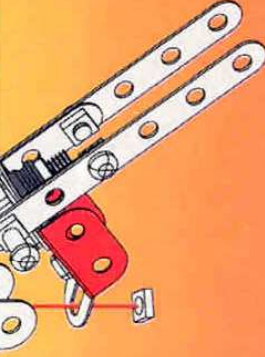
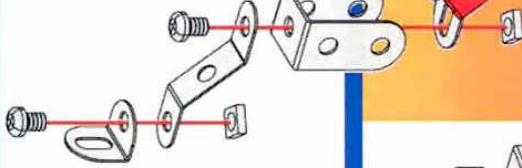
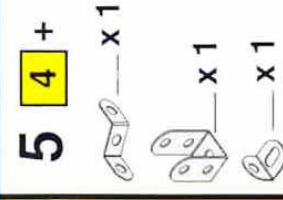
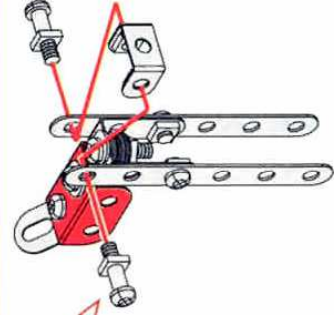
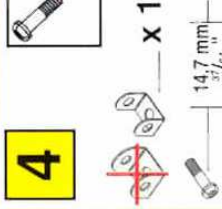
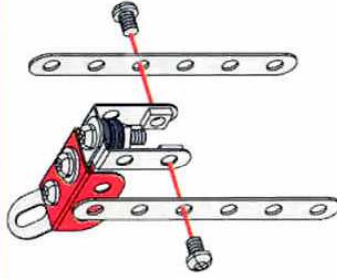
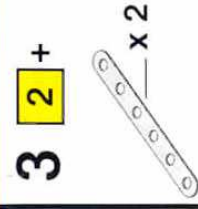
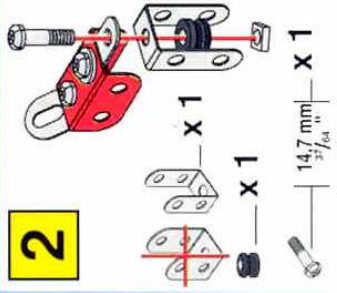
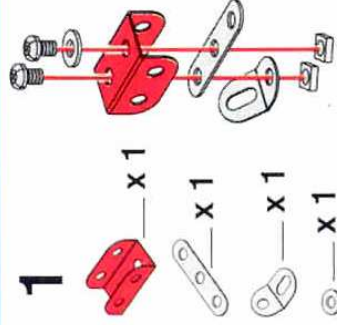
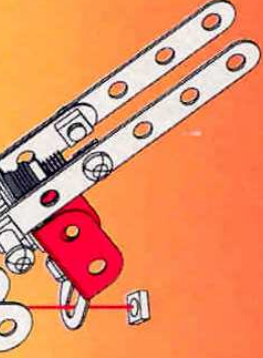
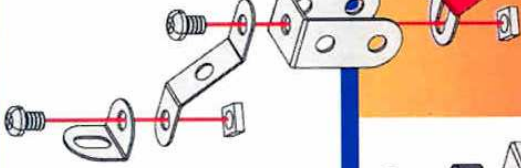
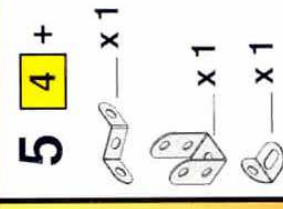
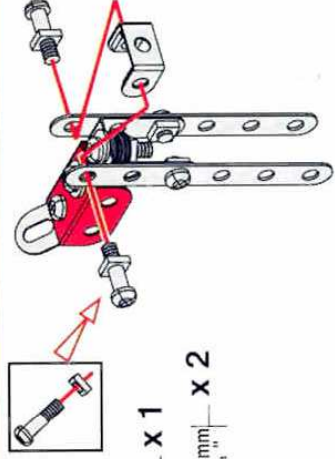
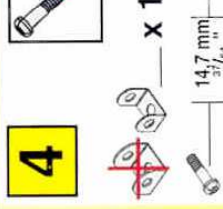
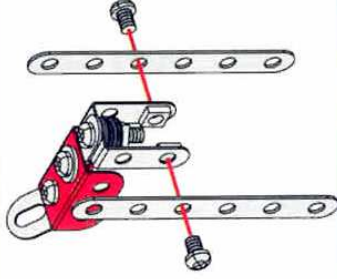
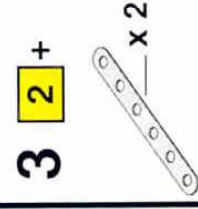
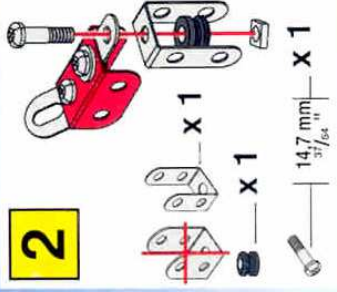
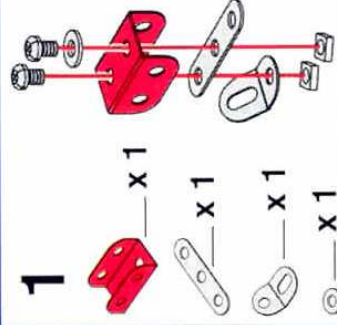

7

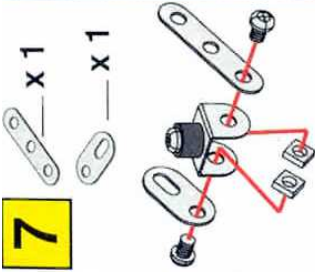

8



x1
x1
9.5 mm
3/8" x1

7

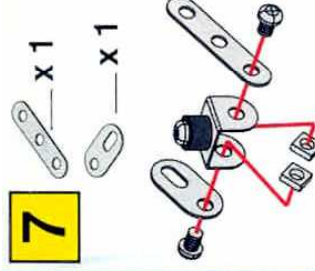

8



x1
x1
9.5 mm
3/8" x1

9

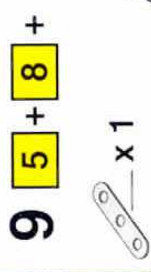

5 + 8



x1

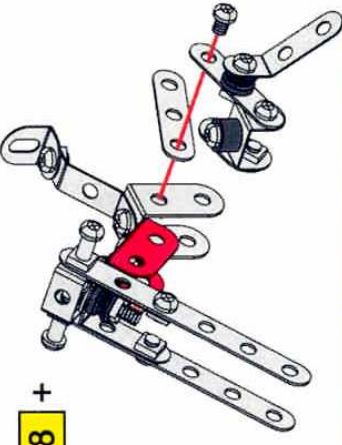

10

x3

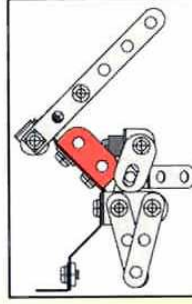

10

x3

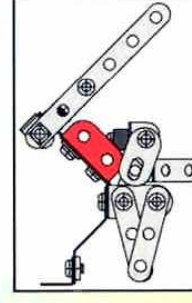

11

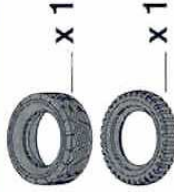

x2

x4

x8

25 mm
1" x2

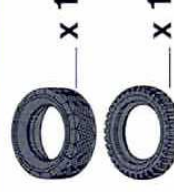

x2

x4

x8

25 mm
1" x2

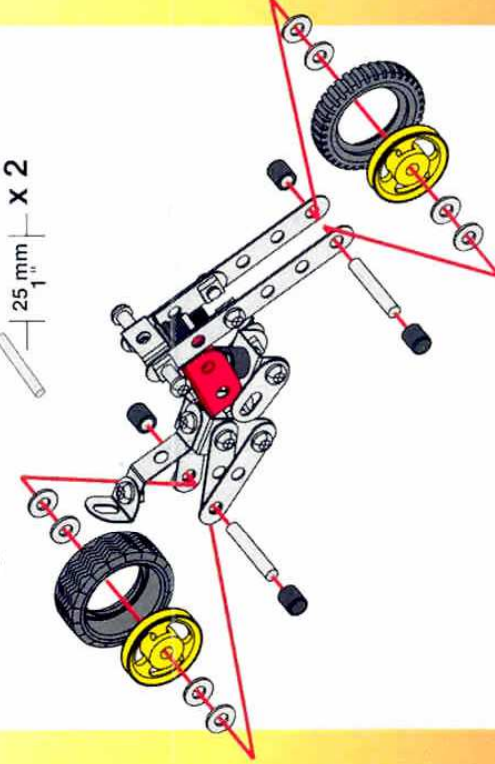
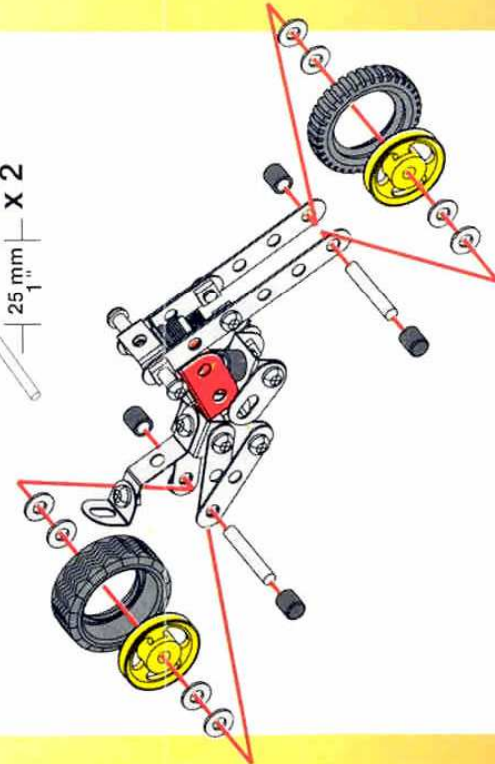

Many of the models and components sold, are unique and original trademarks of MECCANO S.A. in compliance with the laws of the country of origin. They are protected by national legislation on industrial designs, trademarks and/or patents. The use of these models and components without the express written consent of MECCANO S.A. is prohibited. For detailed information, please contact MECCANO S.A. in your country.

De meeste modellen en onderdelen zijn unieke en originele handelsmerken van MECCANO S.A. Deze modellen worden beschermd door de wetgeving van het land van herkomst. Het gebruik van deze modellen en onderdelen zonder de uitdrukkelijke schriftelijke toestemming van MECCANO S.A. is niet toegestaan. Voor meer informatie, zie de afzonderlijke landen.

Firma MECCANO S.A. je značka a výrobky jsou chráněny právně v souladu s právními předpisy země původu. Použití těchto výrobků bez předchozího písemného souhlasu společnosti MECCANO S.A. je zakázáno. Pro podrobnější informace, obraťte se na příslušné úřady v zemi původu.

Unabhängig geschützte Erfindungen sind durch die Markenrechte geschützt. Die Verwendung dieser Modelle und Bauteile ohne die schriftliche Genehmigung von MECCANO S.A. ist ausdrücklich untersagt. Für weitere Informationen wenden Sie sich bitte an MECCANO S.A.

MECCANO S.A. è un marchio registrato, proprietà della MECCANO S.A. e sono protetti dalle leggi nazionali sui diritti di proprietà intellettuale. L'uso di questi modelli e componenti senza il permesso scritto di MECCANO S.A. è espressamente vietato. Per informazioni, rivolgetevi al vostro paese di origine.

MECCANO S.A. je značka a výrobky jsou chráněny právně v souladu s právními předpisy země původu. Použití těchto výrobků bez předchozího písemného souhlasu společnosti MECCANO S.A. je zakázáno. Pro podrobnější informace, obraťte se na příslušné úřady v zemi původu.

MECCANO S.A. je značka a výrobky jsou chráněny právně v souladu s právními předpisy země původu. Použití těchto výrobků bez předchozího písemného souhlasu společnosti MECCANO S.A. je zakázáno. Pro podrobnější informace, obraťte se na příslušné úřady v zemi původu.

MECCANO

92100 Bivoligne-Billancourt - FRANCE

ERECTOR

Distributed by MECCANO® Inc.
1675 Broadway
New York, NY 10019

ERECTOR® instruction booklets are solely to assist in construction of sets MECCANO, Inc. shall have no responsibility for: I. Failure to follow instructions. II. Use of parts for any purpose other than as specified in the instruction booklets III. Any alteration of any parts or components.

ERECTOR® and MECCANO® are exclusive trademarks of Meccano S.A.
© 1994 Meccano S.A. Made in France by MECCANO Avenue de Saint Exupéry, 62100 CALAIS.