

2202

1

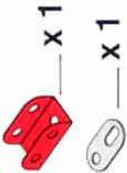

2

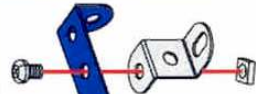
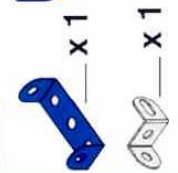

3

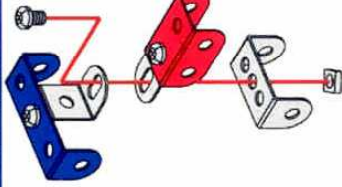
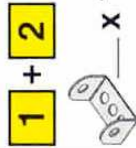

4

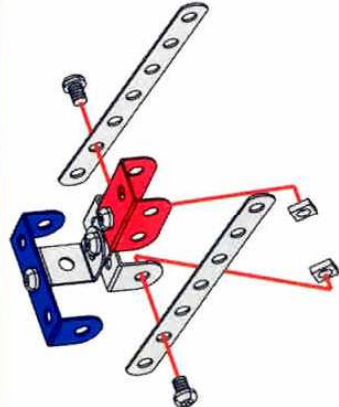
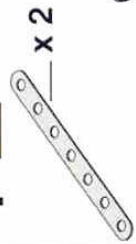

5

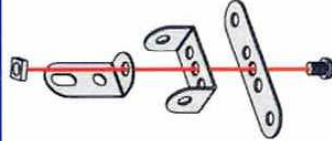
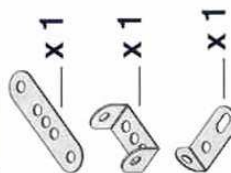

6

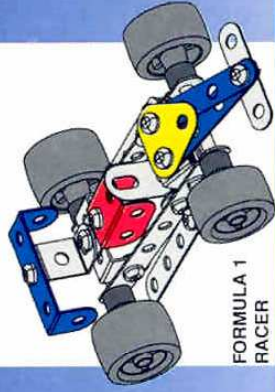
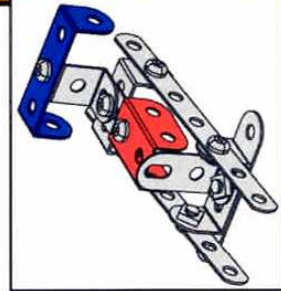
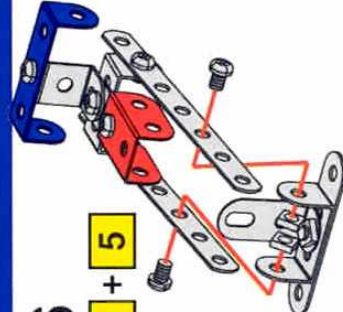

FORMULA 1  
RACER

2202

1

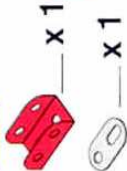

2

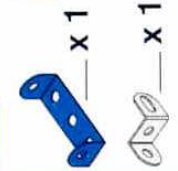

3

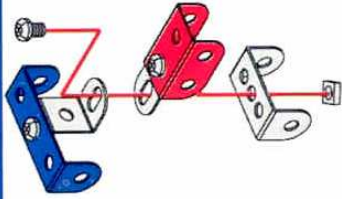
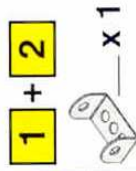

4

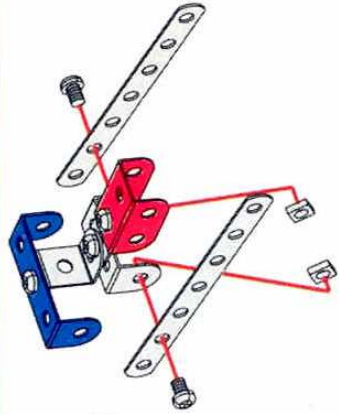
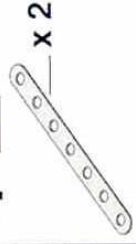

5

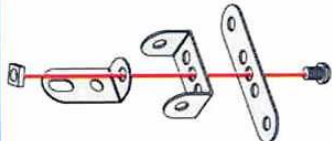
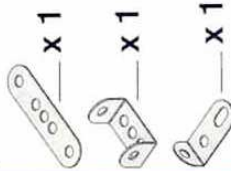

6

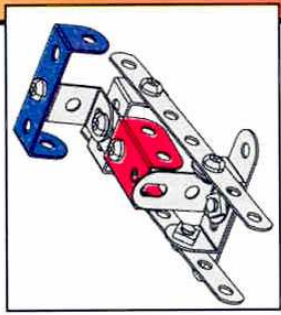
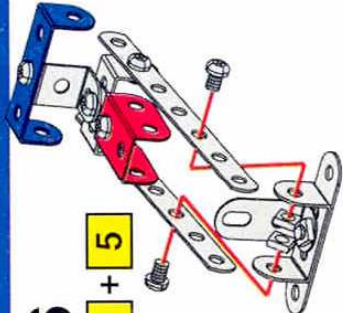

7

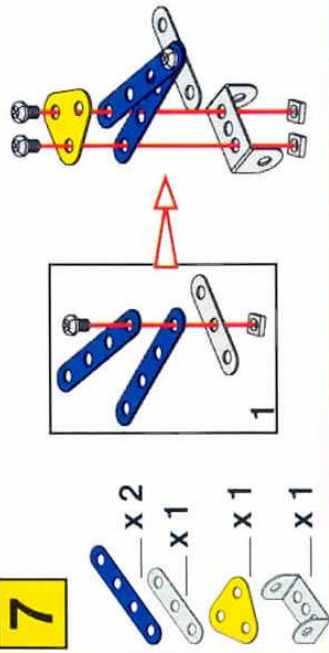

7

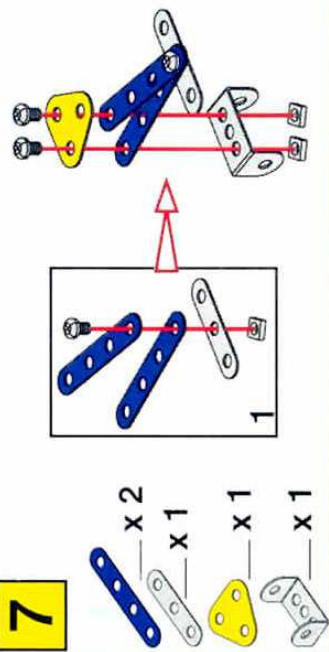

- x 2
- x 1
- x 1
- x 1

- x 2
- x 1
- x 1
- x 1

8

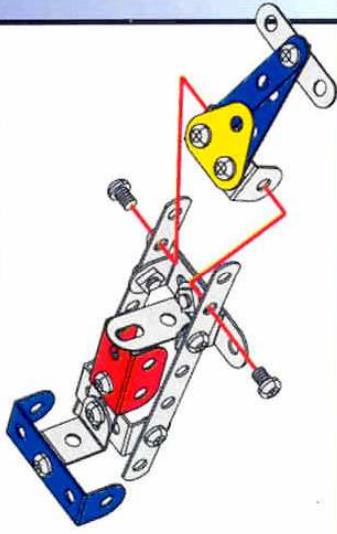

6 + 7

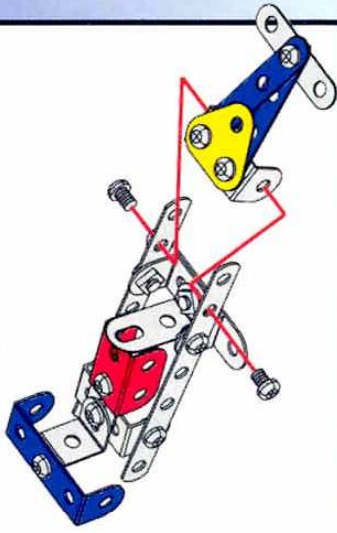

- x 2
- x 1
- x 1
- x 1

- x 2
- x 1
- x 1
- x 1

9

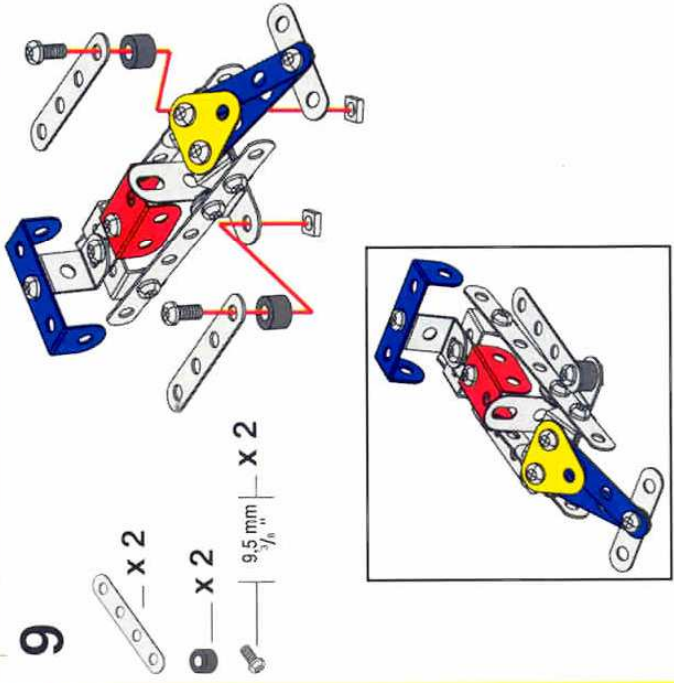

- x 2
- x 2
- x 2
- 9,5 mm 3/8" x 2

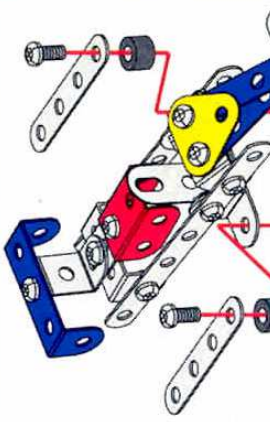
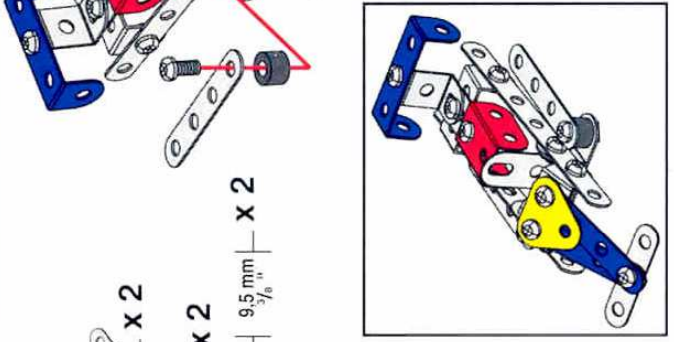

- x 2
- x 2
- x 2
- 9,5 mm 3/8" x 2

- x 2
- x 2
- x 2
- 9,5 mm 3/8" x 2

10

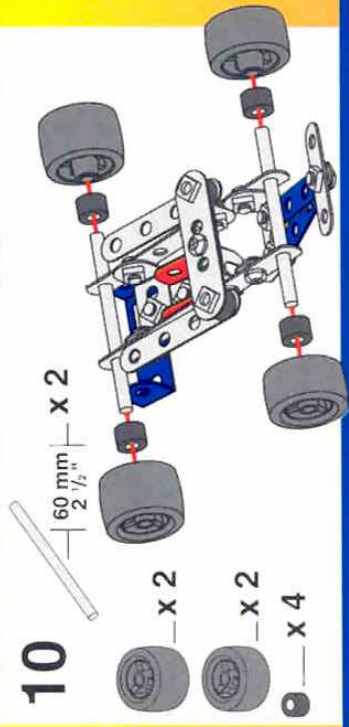

- 60 mm 2 1/2" x 2
- x 2
- x 2
- x 4

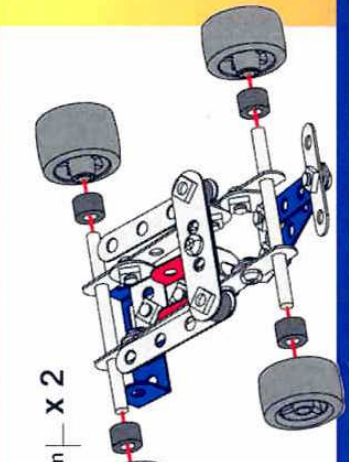

- 60 mm 2 1/2" x 2
- x 2
- x 2
- x 4

Many of the models and component parts are unique and original designs which are the property of MECCANO S.A. They are protected by national legislation as industrial designs, trademarks and/or patents in various countries. For detailed information, please contact MECCANO S.A. in any country.

De nombreux modèles et pièces sont des créations originales, propriété de MECCANO S.A. Ils sont protégés par les lois nationales et internationales en matière de brevets, de marques et de droits de propriété industrielle. Pour toute information, merci de contacter MECCANO S.A. dans n'importe quel pays.

Zahlreiche Modelle und Teile sind Erfindungen und Eigentum der MECCANO S.A. Sie sind durch nationale und internationale Gesetze zum Patentrecht, Markenrecht und zum Urheberrecht geschützt. Für zusätzliche Auskünfte wenden Sie sich bitte an MECCANO S.A. in jedem Land.

Многие модели и детали являются оригинальными разработками MECCANO S.A. и охраняются законодательством различных стран в области патентного права, товарных знаков и авторских прав. Для получения дополнительной информации обращайтесь к MECCANO S.A. в любой стране.

Многие модели и детали являются оригинальными разработками MECCANO S.A. и охраняются законодательством различных стран в области патентного права, товарных знаков и авторских прав. Для получения дополнительной информации обращайтесь к MECCANO S.A. в любой стране.

MECCANO S.A. è un marchio registrato di MECCANO S.A. in Italia e in molti altri paesi. MECCANO S.A. è un marchio registrato di MECCANO S.A. in Italia e in molti altri paesi. MECCANO S.A. è un marchio registrato di MECCANO S.A. in Italia e in molti altri paesi.

MECCANO S.A. is a registered trademark of MECCANO S.A. in Italy and in many other countries. MECCANO S.A. is a registered trademark of MECCANO S.A. in Italy and in many other countries. MECCANO S.A. is a registered trademark of MECCANO S.A. in Italy and in many other countries.

MECCANO S.A. is a registered trademark of MECCANO S.A. in Italy and in many other countries. MECCANO S.A. is a registered trademark of MECCANO S.A. in Italy and in many other countries. MECCANO S.A. is a registered trademark of MECCANO S.A. in Italy and in many other countries.

**ERECTOR**

Distributed by MECCANO® inc.  
1675 Broadway  
New York, NY 10019

ERECTOR® instruction booklets are solely to assist in construction of sets. MECCANO inc. shall have no responsibility for: I. Failure to follow instructions. II. Use of parts for any purpose other than as specified in the instruction booklets. III. Any alteration of any parts or components.

ERECTOR® and MECCANO® are exclusive trademarks of Meccano S.A. © 1994 Meccano S.A. Made in France by MECCANO Avenue de Saint Exupéry, 62100 CALAIS.

MECCANO 92100 Boulogne-Billancourt - FRANCE