

MECCANO

1

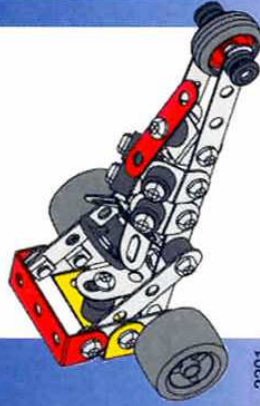

2201

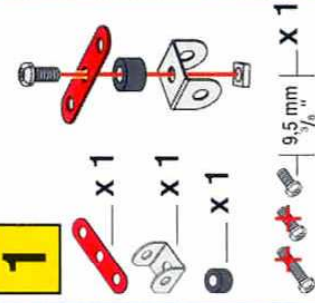

9,5 mm  $\frac{3}{8}$ " x 1

2

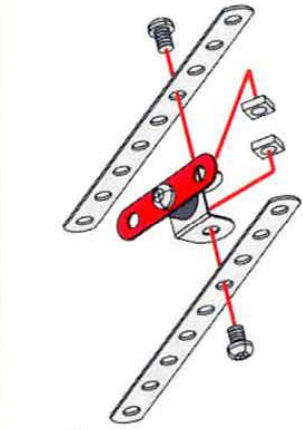
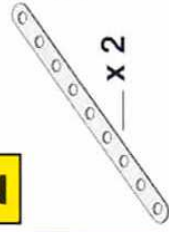

3

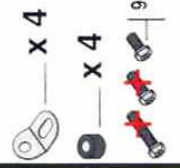

9,5 mm  $\frac{3}{8}$ " x 4

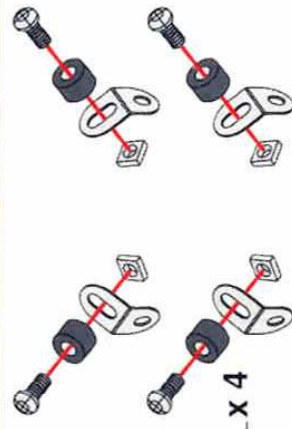

4

2 + 3

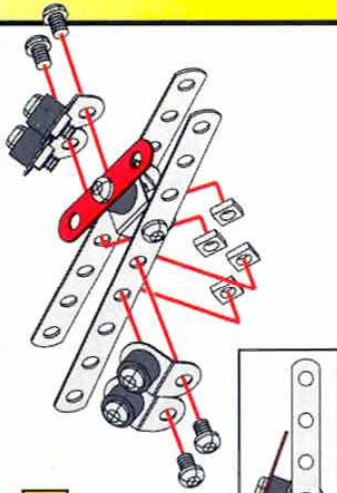
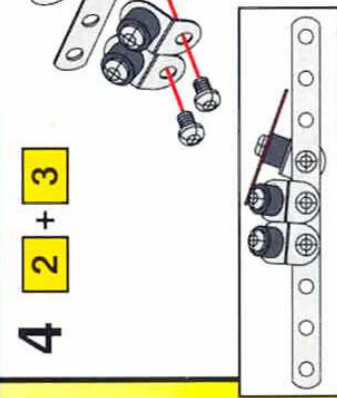

5



12 mm  $\frac{1}{2}$ " x 2

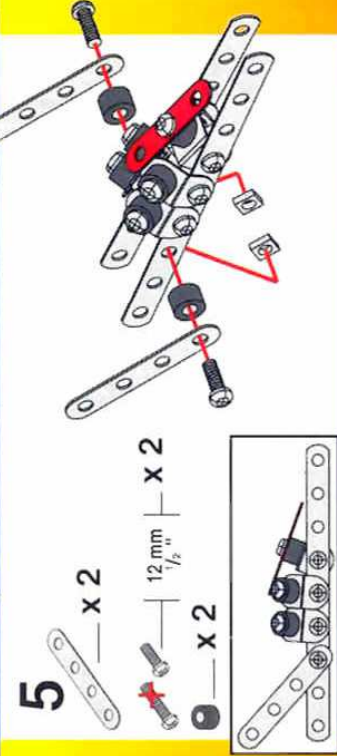

5



12 mm  $\frac{1}{2}$ " x 2

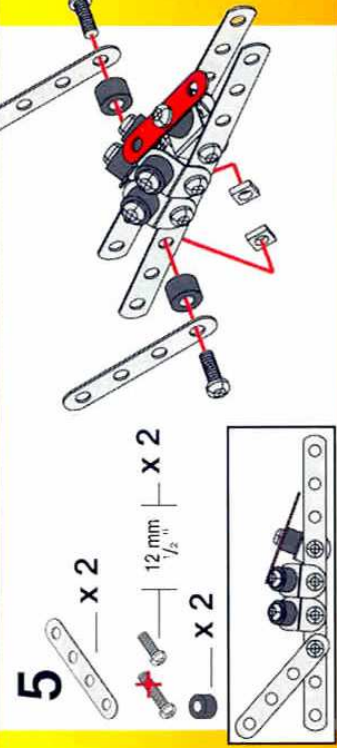

6

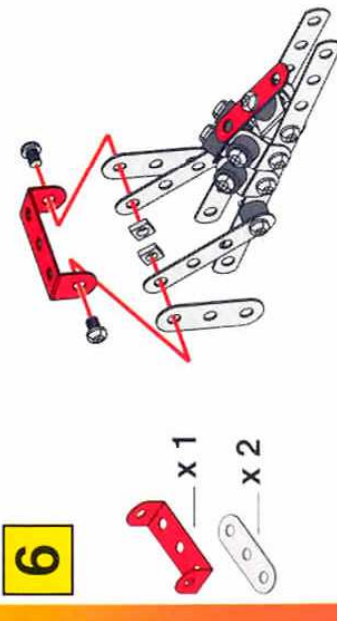

6

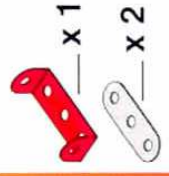

ERECTOR

1

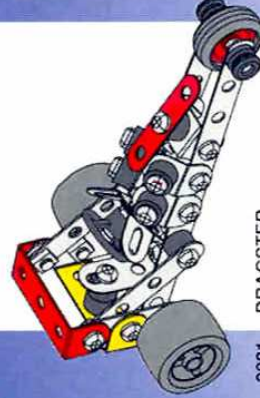

2201

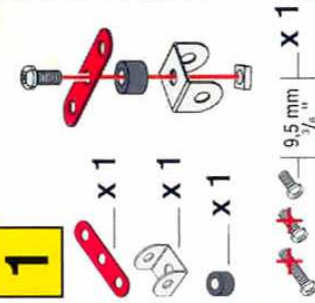

9,5 mm  $\frac{3}{8}$ " x 1

2

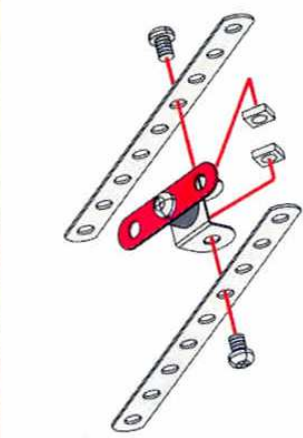
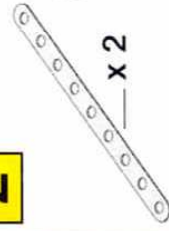

3

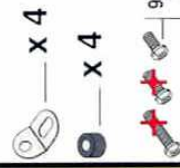

9,5 mm  $\frac{3}{8}$ " x 4

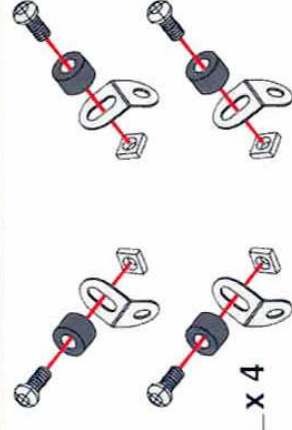

4

2 + 3

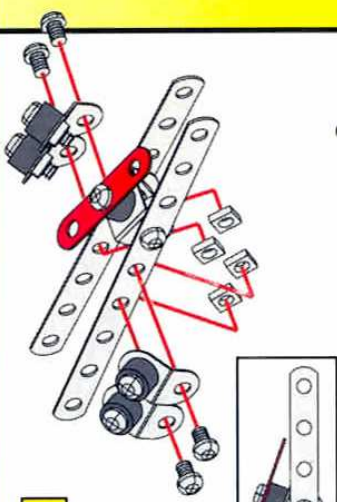
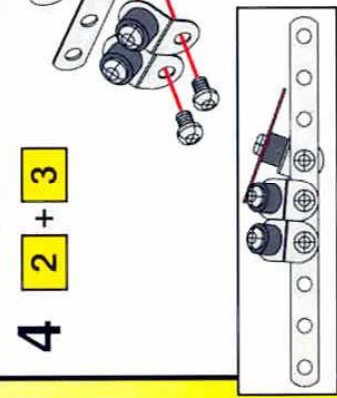

5



12 mm  $\frac{1}{2}$ " x 2

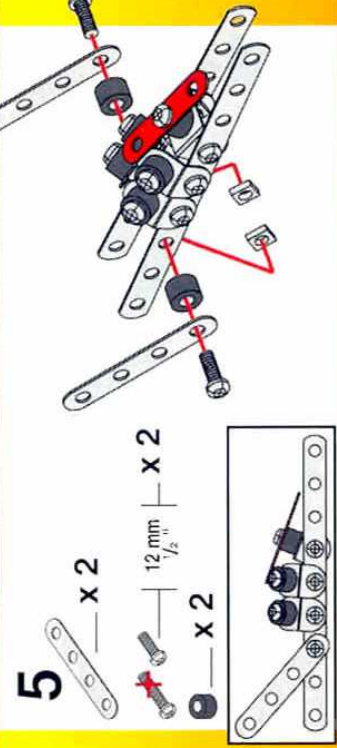

6

