

2105

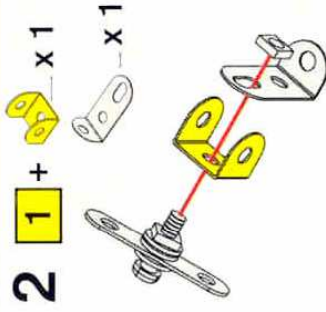
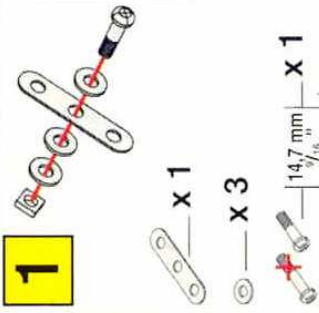
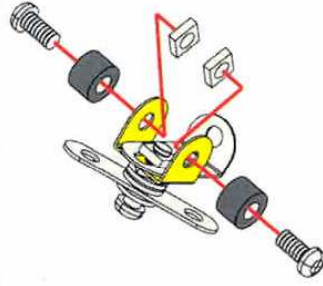

1 x1
 x1
 x3
 14,7 mm $\frac{1}{2}$ " x1

2 **1** + x1
 x1

3

x2
 9,5 mm $\frac{3}{8}$ " x2

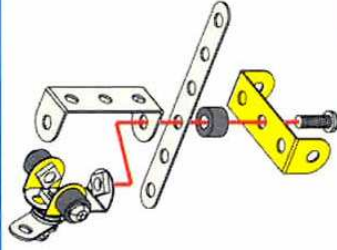
4

3 + x1
 x1
 x1
 12 mm $\frac{1}{2}$ " x1

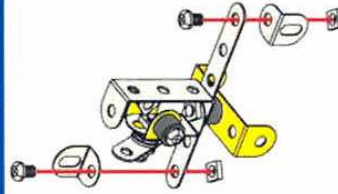
5

x2

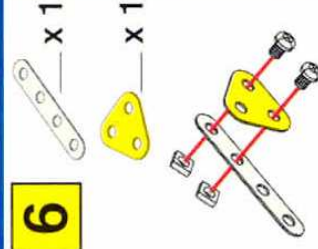

6 x1
 x1

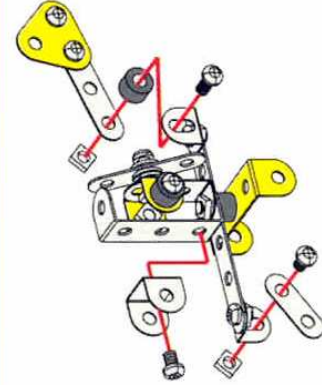
7

5 + **6** + x1
 x1
 x1
 9,5 mm $\frac{3}{8}$ " x1

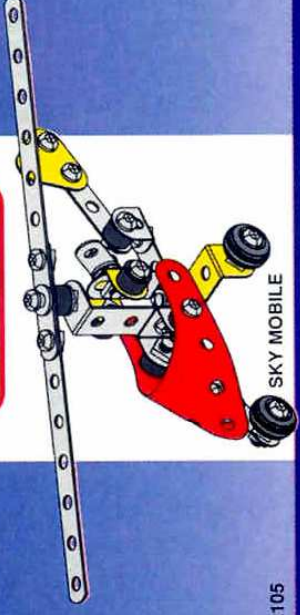

2105

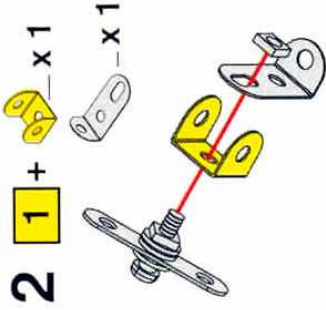
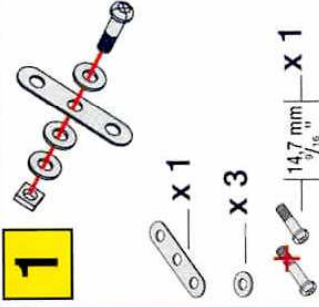

1 x1
 x1
 x3
 14,7 mm $\frac{1}{2}$ " x1

2 **1** + x1
 x1

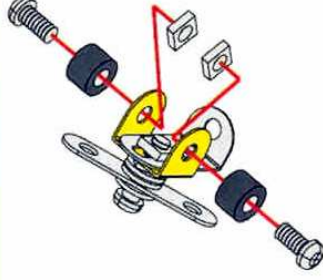
3

x2
 9,5 mm $\frac{3}{8}$ " x2

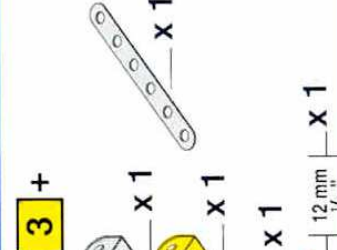
4

3 + x1
 x1
 x1
 12 mm $\frac{1}{2}$ " x1

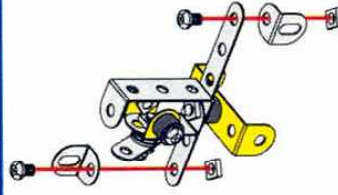
5

x2

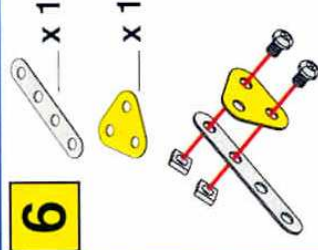

6 x1
 x1

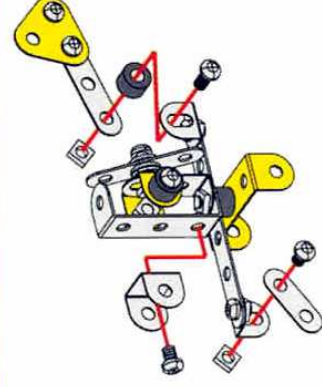
7

5 + **6** + x1
 x1
 x1
 9,5 mm $\frac{3}{8}$ " x1

8

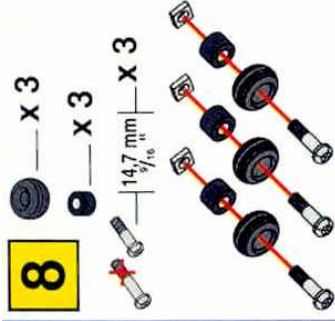

9 7 + 8



8

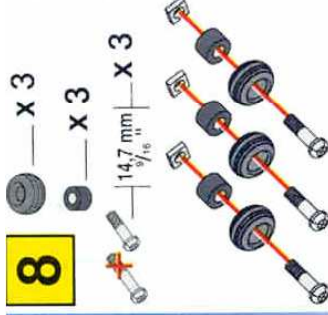

9 7 + 8



10

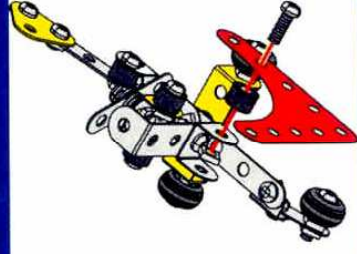
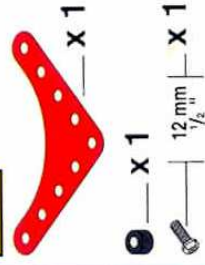

10

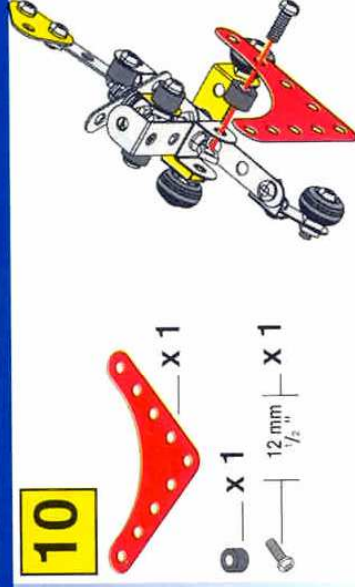

11 10 +

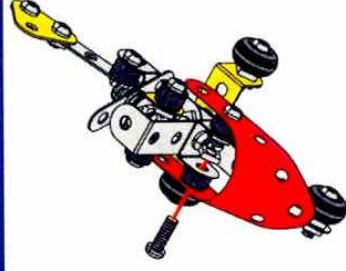
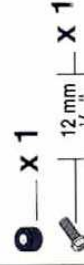

11 10 +

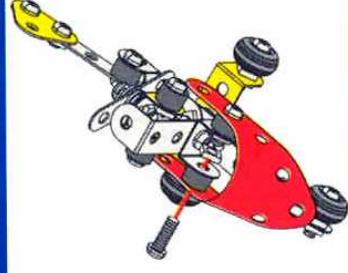
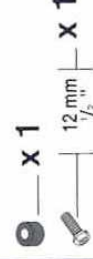

12

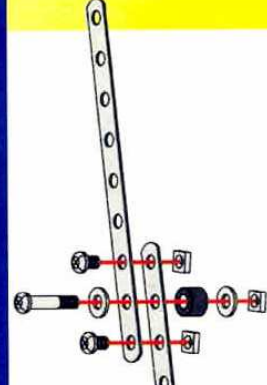
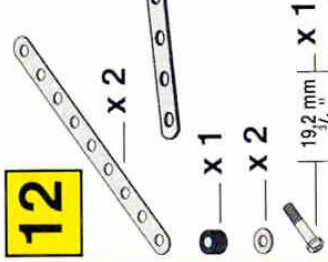

12

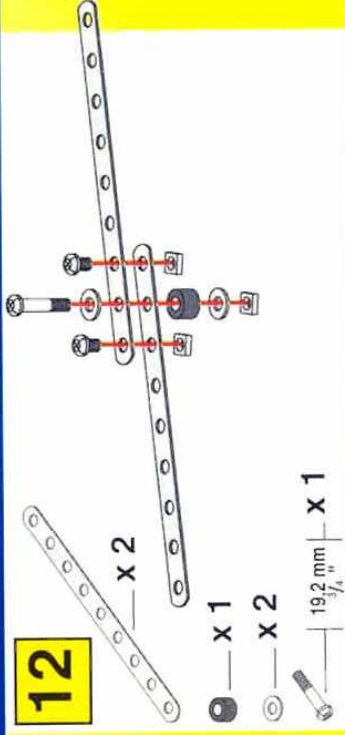

13

11 + 12

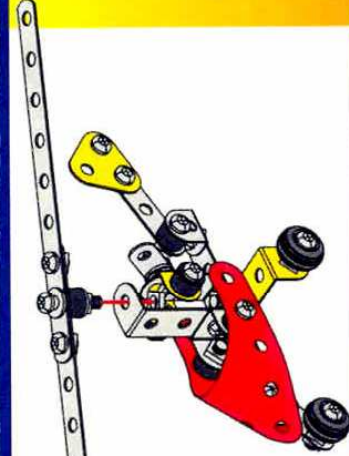

13

11 + 12

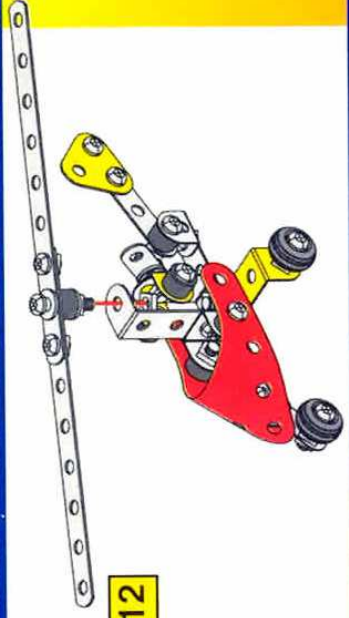

Mainly of the models and component parts are unique and original designs which are the property of MECCANO S.A. They are protected by national legislation as industrial designs, trademarks and/or patents. Any unauthorized reproduction or use without the express written consent of MECCANO S.A. is strictly forbidden. For detailed information, please contact MECCANO S.A. in any country. Die konstruierbaren Modelle sind zum Teil Erfindungen und/oder sind als Modelle, Marken und/oder als Erfindungen geschützt. Die Nachahmung oder die Herstellung von Kopien ohne die schriftliche Genehmigung von MECCANO S.A. ist ausdrücklich untersagt. Für weitere Informationen, wenden Sie sich bitte an MECCANO S.A. in jedem Land. Vor urheberrechtlicher, patentrechtlicher, markenrechtlicher oder sonstiger Verletzung wird ausdrücklich gewarnt. MECCANO S.A. e tutti i propri diritti di legge sono creati originali, protetti dalla legislazione nazionale sui disegni e modelli, marchi e/o diritti di invenzione. È vietata espressamente la riproduzione o l'uso non autorizzato senza la permesso scritto della MECCANO S.A. Per qualsiasi informazione, si prega di contattare MECCANO S.A. in qualsiasi paese. Tutti i diritti sono riservati. Para mais informações, por favor contactar MECCANO S.A. em qualquer país. Este modelo e suas partes são criações originais, protegidas por leis nacionais de patentes, marcas e/ou direitos de invenção. É proibida a reprodução não autorizada sem o consentimento escrito da MECCANO S.A. Para mais detalhes e informações, por favor contactar MECCANO S.A. em qualquer país. Este modelo e suas partes são criações originais, protegidas por leis nacionais de patentes, marcas e/ou direitos de invenção. É proibida a reprodução não autorizada sem o consentimento escrito da MECCANO S.A. Para mais informações, por favor contactar MECCANO S.A. em qualquer país. This model and its parts are original creations, protected by national legislation on patents, trademarks and/or rights of invention. It is forbidden to reproduce or use without the express written consent of MECCANO S.A. For more information, please contact MECCANO S.A. in any country. Modeli i njihove komponente su uglavnom jedinstveni i originalni dizajni, zaštićeni nacionalnim zakonodavstvom kao industrijski dizajni, trgovačke oznake i/ili patenti. Sve neovlaštene reprodukcije ili korištenje bez izričite pisane odobrenosti MECCANO S.A. su strogo zabranjene. Za detaljne informacije, molimo kontaktirati MECCANO S.A. u bilo kojem zemlji. Modeli i njihove komponente su uglavnom jedinstveni i originalni dizajni, zaštićeni nacionalnim zakonodavstvom kao industrijski dizajni, trgovačke oznake i/ili patenti. Sve neovlaštene reprodukcije ili korištenje bez izričite pisane odobrenosti MECCANO S.A. su strogo zabranjene. Za detaljne informacije, molimo kontaktirati MECCANO S.A. u bilo kojem zemlji. Modeli i njihove komponente su uglavnom jedinstveni i originalni dizajni, zaštićeni nacionalnim zakonodavstvom kao industrijski dizajni, trgovačke oznake i/ili patenti. Sve neovlaštene reprodukcije ili korištenje bez izričite pisane odobrenosti MECCANO S.A. su strogo zabranjene. За додаткові відомості, будь ласка, зв'язуйтеся з MECCANO S.A. в будь-якій країні. Modeli i njihove komponente su uglavnom jedinstveni i originalni dizajni, zaštićeni nacionalnim zakonodavstvom kao industrijski dizajni, trgovačke oznake i/ili patenti. Sve neovlaštene reprodukcije ili korištenje bez izričite pisane odobrenosti MECCANO S.A. su strogo zabranjene. За додаткові відомості, будь ласка, зв'язуйтеся з MECCANO S.A. в будь-якій країні.

ERECTOR

Distributed by MECCANO® Inc.
1675 Broadway
New York, NY 10019

ERECTOR® instruction booklets are solely to assist in construction of sets. MECCANO, Inc. shall have no responsibility for: I. Failure to follow instructions. II. Use of parts for any purpose other than as specified in the instruction booklets. III. Any alteration of any parts or components.

ERECTOR® and MECCANO® are exclusive trademarks of Meccano S.A.
© 1984 Meccano S.A. Made in France by MECCANO Avenue de Saint Exupéry, 62100 CALAIS.

MECCANO S.A. 05 bis, rue Balzac
92100 Boulogne-Billancourt - FRANCE