

MECCANOTM
MAKER SYSTEM

HURACAN



16308



RC
2.4GHz
REMOTE CONTROL
RADIOCOMMANDÉ

10+

Instructions
Notice de montage
Instrucciones de construcción
Bauanleitung

Bouwinstructie
Istruzioni
Instruções
Инструкции

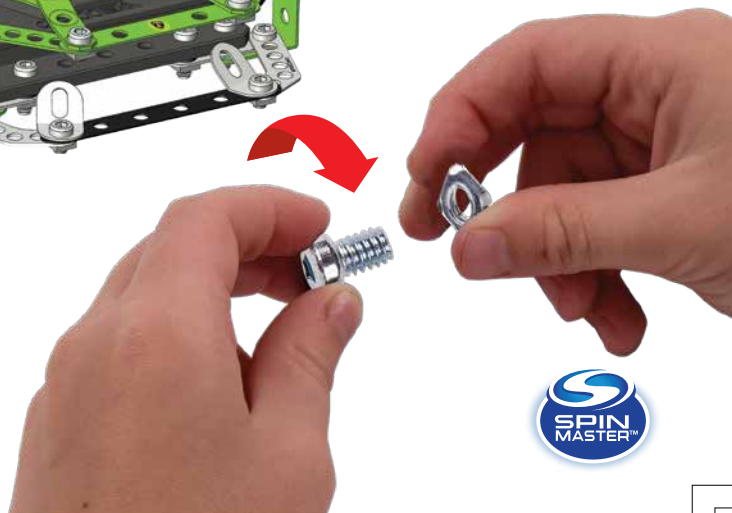



CONSTRUCTION TIPS / ASTUCES DE CONSTRUCTION

TIPS DE CONSTRUCCIÓN / TIPPS ZUM BAUEN
MONTAGETIPS / SUGGERIMENTI PER COSTRUIRE
DICAS DE MONTAGEM / РЕКОМЕНДАЦИИ ПО СБОРКЕ

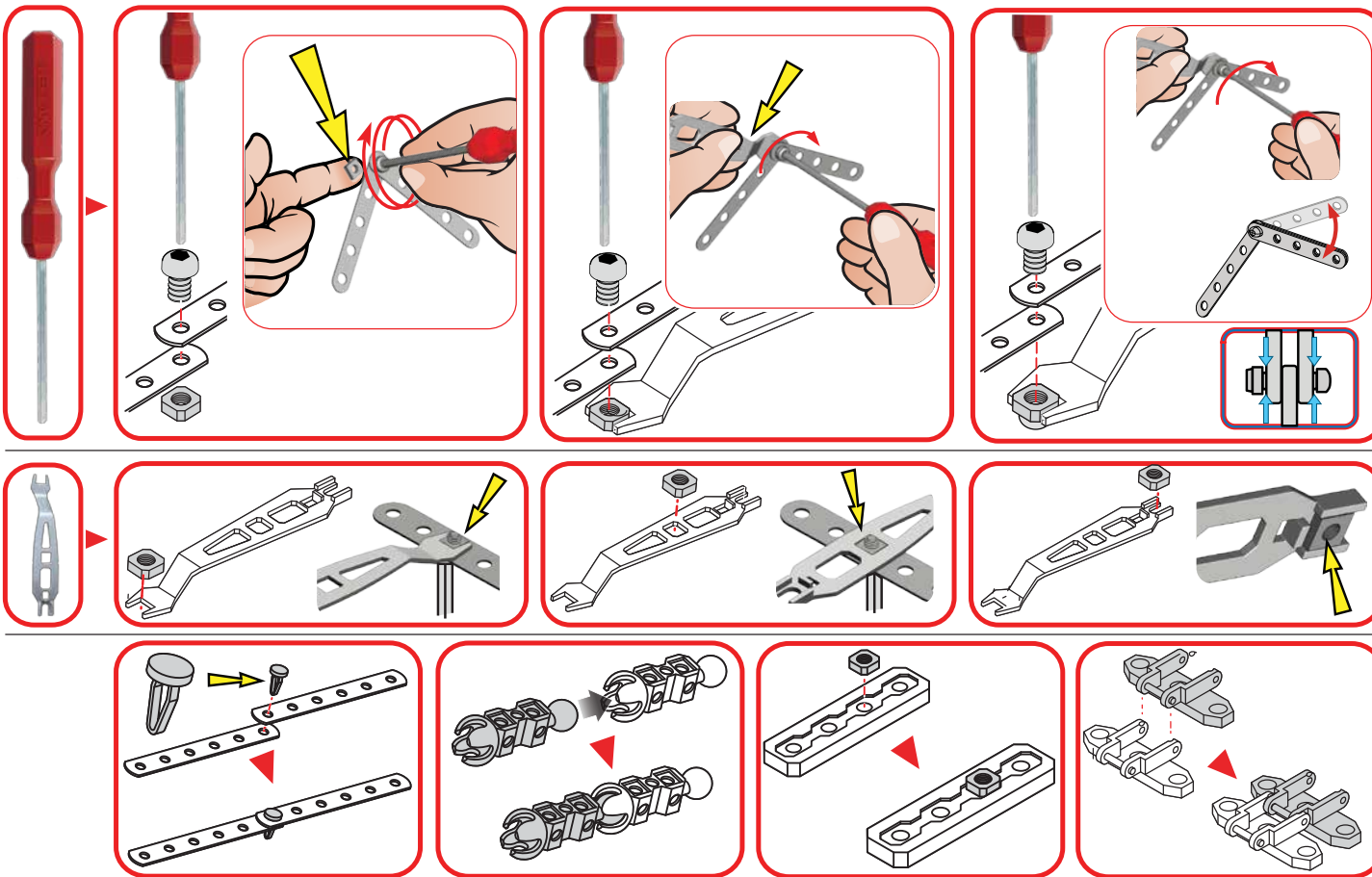

USER GUIDE
GUIDE DE L'UTILISATEUR
GUÍA DEL USUARIO
BEDIENUNGSANLEITUNG
GEbruIKSAANWIJZING
MANUALE DI ISTRUZIONI
MANUAL DO UTILIZADOR
РУКОВОДСТВО ПО ИСПОЛЬЗОВАНИЮ

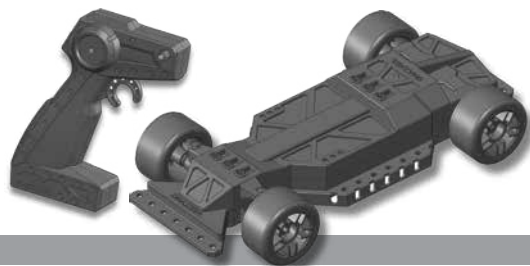

- | | |
|---------------------------|--------------------------------|
| EN INSERTING BATTERIES | NL BATTERIJEN PLAATSEN |
| FR INSERTION DES PILES | IT COME INSERIRE LE PILE |
| ES CÓMO INSERTAR PILAS | PT INTRODUIZIR AS PILHAS |
| DE EINLEGEN DER BATTERIEN | RU УСТАНОВКА ЭЛЕМЕНТОВ ПИТАНИЯ |

- | | |
|-------------|------------|
| EN VEHICLE | NL AUTO |
| FR VÉHICULE | IT VEICOLO |
| ES VEHÍCULO | PT VEÍCULO |
| DE FAHRZEUG | RU МАШИНКА |

- | | |
|-------------------|-----------------|
| EN TRANSMITTER | NL ZENDER |
| FR RADIOCOMMANDE | IT RADIOCOMANDO |
| ES CONTROL REMOTO | PT TRANSMISSOR |
| DE FERNSTEUERUNG | RU ПЕРЕДАТЧИК |

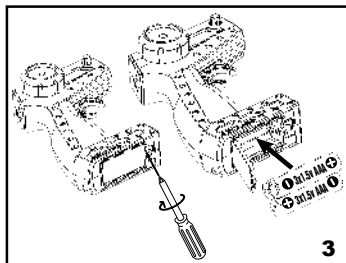

- EN **DO NOT** remove or install batteries using sharp or metal tools.
FR **NE PAS** utiliser d'objet coupant ou métallique pour extraire ou installer les piles.
ES **NO** utilice herramientas metálicas o puntiagudas para instalar o extraer las pilas.
DE Batterien **NICHT** mit scharfen oder metallenen Gegenständen entfernen oder einlegen.
NL Verwijder of plaats batterijen **NIET** met behulp van scherpe of metalen voorwerpen.
IT **NON** usare oggetti metallici o appuntiti per rimuovere o installare le pile.
PT **NÃO** retire ou coloque pilhas com qualquer acessório pontiagudo ou metálico.
RU **ЗАПРЕЩАЕТСЯ** извлекать или устанавливать элементы питания с помощью острых или металлических предметов.

- EN Check your local laws and regulations for correct recycling and/or battery disposal.
FR Consulter la législation locale concernant le recyclage et/ou l'élimination des piles.
ES Consulte la normativa local relativa al reciclaje y desecho de las pilas.

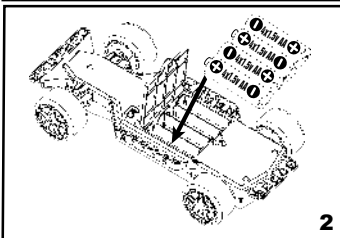
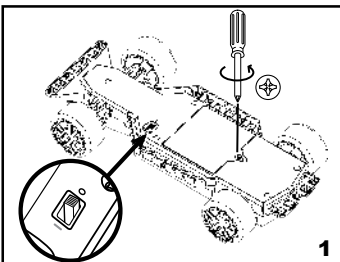

- DE Örtliche Gesetze und Bestimmungen für das Recycling bzw. die Entsorgung von Altbatterien beachten.
NL Lees de plaatselijke voorschriften en regelgeving om de batterij op de juiste wijze te recyden of af te voeren.
IT Eliminare e/o riciclare le pile secondo quanto previsto dalle normative locali vigenti.
PT Consulte as leis, as normas e os regulamentos locais de reciclagem e/ou descarte de pilhas e baterias.
RU Ознакомьтесь с местными законами и нормативами, установленными в отношении правил переработки и/или утилизации элементов питания.

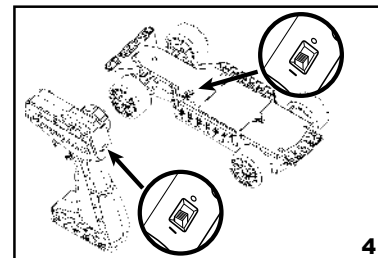

- EN PLAY
FR JEU
ES CÓMO JUGAR
DE SPIELEN
NL SPELEN
IT COME GIOCARE
PT USAR
RU КАК ИГРАТЬ

- EN **WHEN** pairing controller and car, LED will flash. Once pairing is complete, LED will glow solid. When LED flashes slowly, battery is low. To reset, turn off the controller and the car.
FR **AU** moment de la synchronisation radiocommande/voiture, le voyant clignote. Une fois la synchronisation effectuée, le voyant s'allume fixement. Si le voyant clignote lentement, la batterie est faible. Pour réinitialiser, éteindre la radiocommande et la voiture.
ES **AL** emparejar el controlador y el vehículo, el LED parpadea. Después de emparejarlos, el LED brilla de manera fija. Si el LED parpadea lentamente, el nivel de batería es bajo. Para reiniciar, apaga el controlador y el vehículo.
DE **LED** blinkt bei Kopplungsvorgang von Steuergerät und Fahrzeug. Nach erfolgter Kopplung leuchtet die LED. Wenn die LED langsam blinkt, ist der Akku fast leer. Zum Zurücksetzen das Steuergerät und das Fahrzeug ausschalten.
NL **BIJ** het koppelen van controller en auto knippert het lampje. Nadat het koppelen is voltooid, brandt het lampje ononderbroken. Als het lampje langzaam knippert, is de batterij bijna leeg. Om te resetten, schakel de controller en de auto uit.
IT **QUANDO** si associa il radiocomando al veicolo, il LED lampeggia. Una volta che l'associazione è stata completata, il LED si accende di luce fissa. Quando il LED lampeggia lentamente, la batteria è scarica. Per resettare, spegnere il radiocomando e il veicolo.
PT **QUANDO** o controle emparelhar com o carro, o LED piscará. O LED ficará aceso assim que o emparelhamento completar. Quando a bateria estiver fraca, o LED piscará lentamente. Para reiniciar, desligue o controle e o carro.
RU **ПРИ** сопряжении устройства управления и машинки загорится индикатор. Когда сопряжение завершится, индикатор загорится ровным светом. Когда элемент питания разряжен, индикатор горит слабо. Для перезагрузки выключите устройство управления и машинку.

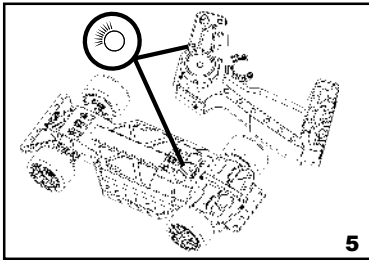

5

EN	ADJUSTING THE DIRECTION	NL	DE RICHTING INSTELLEN
FR	RÉGLAGE DE LA DIRECTION	IT	REGOLARE LA DIREZIONE
ES	CÓMO AJUSTAR LA DIRECCIÓN	PT	AJUSTAR A DIRECÇÃO
DE	EINSTELLEN DER RICHTUNG	RU	КОРРЕКТИРОВАНИЕ НАПРАВЛЕНИЯ

EN TO RESET: MAKE SURE BOTH THE CAR AND CONTROLLER ARE TURNED OFF THEN TURN ON THE CAR FIRST, AND THEN THE CONTROLLER.

FR POUR RÉINITIALISER, S'ASSURER QUE LA VOITURE ET LA RADIOCOMMANDE SONT TOUTES DEUX ÉTEINTES. ENSUITE, ALLUMER D'ABORD LA VOITURE, PUIS LA RADIOCOMMANDE.

ES PARA REINICIAR, COMPROBE QUE EL VEHÍCULO Y EL CONTROLADOR ESTÉN APAGADOS. APAGA PRIMERO EL COCHE Y DESPUÉS EL CONTROLADOR.

DE ZURÜCKSETZEN: DAS STEUERGERÄT UND DAS FAHRZEUG MÜSSEN AUSGESCHALTET SEIN. DANN ZUERST DAS FAHRZEUG UND ANSCHLIEßEND DAS STEUERGERÄT EINSCHALTEN.

NL RESETTEN: ZORG ERVOOR DAT ZOWEL DE AUTO ALS DE CONTROLLER ZIJN UITGESCHAKELD. SCHAKEL DAN EERST DE AUTO WEER IN EN DAN DE CONTROLLER.

IT PER RESETTARE, ASSICURARSI CHE IL RADIOCOMANDO E IL VEICOLO SIANO SPENITI. QUINDI ACCENDERE PRIMA IL VEICOLO E SUCCESSIVAMENTE IL RADIOCOMANDO.

PT PARA REINICIAR: CERTIFIQUE-SE DE QUE TANTO O CARRO QUANTO O CONTROLE ESTEJAM DESLIGADOS. LIGUE O CARRO PRIMEIRO E DEPOIS O CONTROLE.

RU ПЕРЕЗАГРУЗКА: УБЕДИТЕСЬ, ЧТО УСТРОЙСТВО УПРАВЛЕНИЯ И МАШИНКА ВЫКЛЮЧЕНЫ. СНАЧАЛА ВКЛЮЧИТЕ МАШИНКУ, ЗАТЕМ УСТРОЙСТВО УПРАВЛЕНИЯ.

EN STEERING KNOB; TRIM ADJUST (TO CORRECT STEERING DRIFT); STOP/REVERSE; ACCELERATE

FR BOUTON DE COMPENSATION ; RÉGLAGE DE LA COMPENSATION (POUR CORRIGER LA DÉRIVE DE DIRECTION) ; ARRÊTER/MARCHE ARRIÈRE ; ACCÉLÉRER

ES VOLANTE DE DIRECCIÓN; AJUSTE DE NIVELACIÓN (PARA CORREGIR LOS CAMBIOS DE DIRECCIÓN); PARADA/MARCHA ATRÁS; ACCELERADOR

DE LENKUNG; TRIMMREGLER (ZUR KORREKTUR, WENN STEUERUNG NACH RECHTS/LINKS ZIEHT); STOPP/RÜCKWÄRTSGANG; BESCHLEUNIGEN

NL STUURKIOP; TRIMREGULATOR (OM STUURDRIFT TE CORRIGEREN); STOP/ACHTERUIT; VERSNELLEN

IT MANOPOLA DI STABILIZZAZIONE; REGOLAZIONE DELL'ASSETTO (PER CORREGGERE LA STABILIZZAZIONE DIREZIONALE); ARRESTO/RETROMARCIA; ACCELERAZIONE

PT BOTÃO DE DIREÇÃO; AJUSTE DO AEROFÓLIO (PARA CORRIGIR O DESVIO DA DIREÇÃO); PARAR/RÉ; ACCELERAR

RU КНОПКА УПРАВЛЕНИЯ; КАЛИБРОВКА (КОРРЕКТИРОВАТЬ УГОЛ ОТКЛОНЕНИЯ); ОСТАНОВКА/ЗАДНИЙ ХОД; РАЗГОН

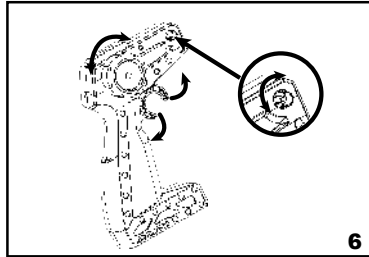

6



EN STANDARDS AND COMPLIANCE CERTIFICATE

1- Hereby Spin Master International SARL declares that this car is in compliance with the essential requirements and other relevant provisions of Directive 1999/5/EC. A copy of the declaration of conformity can be requested at customerscare@spinmaster.com or Spin Master international S.A.R.L., 16 Avenue Pasteur, L-2310, Luxembourg
2- This product is for indoor use only.

SAFETY RULES

Choose a SAFE place in which to operate the vehicle. Not to be operated on the street. Avoid use on SAND or in puddles as this may damage its performance. Check the area in which the vehicle will be operated and carefully avoid obstacles.

The radio aeriars of the vehicles and transmitters are delicate. Do not leave close to a HEAT source or in broad SUNLIGHT for long periods. Avoid leaving the vehicle or transmitter OUTDOORS OVERNIGHT. NIGHT HUMIDITY IS HARMFUL TO THE INTERIOR MECHANISM.

WARNING

The antenna is not to be inserted into socket-outlets. * ANY CHANGES OR MODIFICATIONS CARRIED OUT WITHOUT MANUFACTURER'S APPROVAL MAY REMOVE THE USER'S RIGHT TO OPERATE THIS TOY.

RADIO INTERFERENCE: Irregular behaviour or loss of control of the vehicle may result from proximity to high voltage wires, high voltage transformers, certain building types, concrete walls or narrow spaces in which RADIO SIGNALS from the transmitter MAY BE DIFFUSED, thus making it difficult for the vehicle to receive a GOOD RADIO SIGNAL. In the case of this behaviour or loss of control, MOVE TO ANOTHER PLAY AREA. There will be INTERFERENCE if ANOTHER radio controlled vehicle or CB radio are operating in close proximity on the same FREQUENCY.

FR CERTIFICAT ATTESTANT DU RESPECT DES NORMES ET DE LA CONFORMITÉ

1 - Par la présente, Spin Master International SARL déclare que cette voiture est conforme aux exigences essentielles et autres dispositions pertinentes de la Directive 1999/5/CE. Une copie de la déclaration de conformité peut être obtenue par courriel à l'adresse servicecf@spinmaster.com ou par courrier à l'adresse suivante : Spin Master international S.A. R. L., 16 Avenue Pasteur, L-2310, Luxembourg.
2- Ce produit est conçu pour être utilisé en intérieur seulement.

RÈGLES DE SÉCURITÉ

Utiliser le véhicule dans un endroit SÛR. Ne pas utiliser le véhicule dans la rue. Éviter d'utiliser le véhicule dans le SABLE ou dans les flaques d'eau ; cela pourrait nuire à son fonctionnement. Avant d'utiliser le véhicule, vérifier que la zone est dégagée de tout obstacle. Les antennes radio des véhicules et des radiocommandes sont des éléments fragiles. Ne pas les exposer à proximité d'une source de CHALEUR ou à la lumière directe du SOLEIL pendant une période prolongée.

Éviter d'entreposer le véhicule ou la radiocommande À L'EXTÉRIEUR PENDANT LA NUIT. L'HUMIDITÉ NOCTURNE EST NOCIVE POUR LE MÉCANISME INTERNE.

ATTENTION !

L'antenne ne doit pas être insérée dans les prises électriques. * TOUT CHANGEMENT OU MODIFICATION APPORTÉ SANS L'ACCORD DU FABRICANT PEUT ANNULER L'AUTORISATION DE L'UTILISATEUR À UTILISER CE JOUET.

SOURCES D'INTERFÉRENCE RADIO : un comportement irrégulier ou une perte de contrôle du véhicule peuvent être causés par la proximité avec des lignes à haute tension, des transformateurs à haute tension, certains types de bâtiments, des murs en béton ou des espaces restreints dans lesquels les SIGNAUX RADIO de la radiocommande peuvent être dispersés, compliquant la BONNE RÉCEPTION DU SIGNAL RADIO par le véhicule. Si tel est le cas, CHANGER DE SURFACE DE JEU.

Des INTERFÉRENCES se produiront si un AUTRE véhicule radiocommandé ou une autre radio CB fonctionnent à proximité immédiate sur la même FRÉQUENCE.

ES CERTIFICADO DE CUMPLIMIENTO Y NORMATIVA

1. Por la presente, Spin Master International SARL declara que este coche cumple con los requisitos esenciales y otras provisiones relevantes de la Directiva 1999/5/EC. Se puede solicitar una copia de la declaración de conformidad en servicio@spinmaster.com o Spin Master International S.A.R.L., 16 Avenue Pasteur, L-2310, Luxembourg.
2- Este producto debe utilizarse únicamente en interiores.

NORMAS DE SEGURIDAD

El vehículo debe utilizarse en un lugar SEGURO. No debe utilizarse en la calle. Se debe evitar el uso en ARENA o charcos; podrían afectar al funcionamiento. Compruebe la zona en la que se vaya a usar el vehículo y evite los obstáculos con cuidado.

Las antenas de radio de los vehículos y los transmisores son delicados. No se debe dejar el vehículo cerca de una fuente de CALOR o expuesto al SOL durante largos periodos de tiempo.

Se debe evitar dejar el vehículo o el control remoto EN EXTERIORES DURANTE LA NOCHE. LA HUMEDAD NOCTURNA RESULTA DAÑINA PARA EL MECANISMO INTERNO.

ADVERTENCIA

La antena no debe insertarse en los enchufes. * CUALQUIER CAMBIO O MODIFICACIÓN REALIZADOS SIN LA APROBACIÓN DEL FABRICANTE PODRÍA ANULAR EL DERECHO DE USO DEL JUGUETE POR PARTE DEL USUARIO.

INTERFERENCIAS DE RADIO: puede darse un comportamiento irregular o pérdida de control del vehículo como resultado de la proximidad a cables y transformadores de alta tensión, ciertos tipos de edificio, muros de hormigón o espacios estrechos en los que SE PODRÍAN DISPERSAR las SEÑALES DE RADIO, lo que dificultaría la recepción de una BUENA SEÑAL DE RADIO por parte del vehículo. En caso de notar este comportamiento o pérdida de control, debe MOVESE A OTRA ZONA DE JUEGO.

Se producirán INTERFERENCIAS si se está utilizando cerca OTRO vehículo de radiocontrol o una radio CB que usen la misma FRECUENCIA.

DE NORMEN UND ZERTIFIKATE

1- Spin Master International SARL erklärt hiermit, dass dieses Fahrzeug den grundlegenden Anforderungen und weiteren Bestimmungen der Richtlinie 1999/5/EG entspricht. Ein Exemplar der Konformitätserklärung kann per E-Mail an Kundenservice@spinmaster.com oder bei Spin Master International S.A.R.L., 16 Avenue Pasteur, L-2310, Luxembourg, angefordert werden.
2- Dieses Produkt ist nur zur Verwendung in Innenräumen vorgesehen.

SICHERHEITSHINWEISE

Fahrzeug nur an SICHEREN Orten verwenden. Nicht auf der Straße spielen. Nicht auf SAND oder durch Pfützen fahren, da dies die Leistung beeinträchtigen kann.

Spielbereich sorgfältig prüfen und Hindernisse meiden. Die Antennen der Fahrzeuge und Sender sind empfindliche Teile. Nicht über längere Zeit hinweg HITZEQUELLEN oder direktem SONNENLICHT aussetzen.

Fahrzeug oder Sender nicht über Nacht im Freien lassen. DIE LUFTFEUCHTIGKEIT IST NACHTS BESONDERS HOCH UND KÖNNTE DEN MECHANISMUS IM INNEREN BESCHÄDIGEN.

ACHTUNG

Die Antenne darf nicht in Steckdosen eingeführt werden. * ÄNDERUNGEN ODER MODIFIKATIONEN, DIE OHNE GENEHMIGUNG DES HERSTELLERS VORGENOMMEN WERDEN, KÖNNEN DAS RECHT DES NUTZERS AUF DIE VERWENDUNG DES SPIELZEUGES NICHTIG MACHEN. FUNKSTÖRUNG: Ungewöhnliches Verhalten des Fahrzeugs oder Verlust der Kontrolle über das Fahrzeug können durch Hochspannungsleitungen und -transformatoren, bestimmte Gebäudetypen, Betonwände oder beengte Räume verursacht werden, in denen das FUNKSIGNAL des Senders gestört wird und das Fahrzeug keinen GUTEN FUNKEMPFANG hat. Bei ungewöhnlichem Fahrzeugverhalten oder Kontrollverlust AN EINEM ANDEREN ORT ERNEUT VERSUCHEN.

Es kann auch zu STÖRUNGEN kommen, wenn ein ANDERES ferngesteuertes Fahrzeug oder ein CB-Funkgerät mit derselben FREQUENZ in unmittelbarer Nähe verwendet wird.

NL RICHTLIJNEN EN COMPLIANCE-CERTIFICAAT

1- Hierbij verklaart Spin Master International SARL dat deze auto voldoet aan de noodzakelijke vereisten en andere voorwaarden in richtlijn 1999/5/EG. U kunt een kopie van deze conformiteitsverklaring opvragen via customercare@spinmaster.com of Spin Master International S.A.R.L., 16 Avenue Pasteur, L-2310, Luxemburg. 2- Dit product is uitsluitend bedoeld voor gebruik binnenshuis.

VEILIGHEIDSVOORSCHRIFTEN

Gebruik de auto alleen op een VEILIGE plaats. Niet geschikt voor gebruik op straat. Vermijd contact met ZAND of water. Dit kan de prestaties negatief beïnvloeden. Controleer de omgeving waarin de auto wordt bestuurd op obstakels en verwijder deze indien nodig. De antennes van de auto en zender zijn kwetsbaar. Niet in de buurt plaatsen van een WARMTEBRON of in fel ZONLICHT gedurende lange perioden.

Laat de auto en de zender 's nachts niet BUITEN staan. NACHTVOCHT IS SCHADELIJK VOOR HET MECHANISME.

WAARSCHUWING

De antenne mag niet in stopcontacten worden gestoken.
* EVENTUELE WIZIGINGEN OF AANPASSINGEN DIE WORDEN UITGEVOERD ZONDER GOEDKEURING VAN DE FABRIKANT, KUNNEN DE GEBRUIKER HET RECHT ONTNEEMEN OM DIT SPEELGOED TE GEBRUIKEN.

RADIO-INTERFERENTIE: onregelmatige gedraging of verlies van de controle over de auto kunnen het gevolg zijn van nabijheid van hoogspanningskabels, hoogspannings- transformatoren, bepaalde soorten gebouwen, betonnen muren of smalle ruimten waarin RADIOSIGNALEN van de zender KUNNEN WORDEN VERSTOORD, waardoor de auto geen GOED RADIOSIGNAAL meer ontvangt. In het geval van dit gedrag en het verlies van controle, kun je het beste naar een ANDER SPEELGEBIED gaan.
Er is sprake van INTERFERENTIE als een ANDER radiobestuurde voertuig of CB-radio in de nabije omgeving op dezelfde frequentie wordt gebruikt.

IT STANDARD E CERTIFICATO DI CONFORMITÀ

1- Con la presente, Spin Master International SARL dichiara che questa autovettura è in regola con i requisiti essenziali e altre clausole rilevanti della Direttiva 1999/5/EC. Una copia della dichiarazione di conformità può essere richiesta all'indirizzo customercare@spinmaster.com o Spin Master International S.A.R.L., 16 Avenue Pasteur, L-2310, Lussemburgo.

2- Questo prodotto deve essere utilizzato esclusivamente in luoghi chiusi.

NORME DI SICUREZZA

Scegliere un luogo SICURO in cui utilizzare il veicolo. Non usare il veicolo in strada. Evitare SABBIA e pozzanghere per non compromettere il funzionamento del veicolo. Controllare l'area in cui si utilizza il veicolo e accertarsi di evitare eventuali ostacoli.

Le antenne radio dei veicoli e dei trasmettitori sono delicate. Non lasciarle in prossimità di fonti di CALORE o esposte alla LUCE DEL SOLE per periodi di tempo prolungati.

Non lasciare il veicolo o il radiocomando ALL'APERTO DURANTE LA NOTTE. L'UMIDITÀ POTREBBE DANNEGGIARNE I MECCANISMI INTERNI.

ATTENZIONE

Non inserire l'antenna in una presa di corrente.

* QUALSIASI MODIFICA O ALTERAZIONE EFFETTUATA SENZA L'APPROVAZIONE DEL PRODUTTORE POTREBBE INVALIDARE IL DIRITTO DELL'UTENTE A UTILIZZARE IL GIOCATTOLO.

INTERFERENZE RADIO: comportamenti inattesi o perdita di controllo del veicolo possono verificarsi in prossimità di cavi di alto voltaggio, trasformatori di alto voltaggio, alcuni tipi di edifici, pareti in calcestruzzo o spazi ristretti. In queste circostanze, i SEGNALI RADIO del trasmettitore POTREBBERO ESSERE PREGIUDICATI, impedendo una ricezione ottimale da parte del veicolo. In caso di tali comportamenti o di perdita di controllo, SPOSTARSI IN UN'ALTRA AREA DI GIOCO.

Sono possibili INTERFERENZE se radio CB o ALTRI veicoli radiocomandati vengono utilizzati in prossimità del giocattolo sulla stessa FREQUENZA.

PT CERTIFICADO DE NORMAS E CONFORMIDADE

1- A Spin Master International SARL declara pelo presente que este automóvel está em conformidade com os requisitos essenciais e outras disposições relevantes da Directiva 1999/5/CE. Pode pedir uma cópia da declaração de conformidade através de customercare@spinmaster.com ou à Spin Master International S.A.R.L., 16 Avenue Pasteur, L-2310, Luxemburgo.

2- Este produto destina-se apenas a uso interior.

REGRAS DE SEGURANÇA

Escolha um local SEGURO para usar o veículo. Não utilizar na rua. Evitar a utilização em AREIA ou em charcos, já que isto poderá infligir danos ao desempenho do veículo. Verifica a área em que vais utilizar o veículo e evita cuidadosamente quaisquer obstáculos.

As antenas de rádio dos veículos e os transmissores são frágeis. Não deixes o veículo perto de uma fonte de CALOR ou sob LUZ SOLAR directa durante períodos de tempo prolongados.

Evita deixar o veículo ou o transmissor no EXTERIOR DURANTE A NOITE. A HUMIDADE NOTURNA É PREJUDICIAL PARA O MECANISMO INTERIOR.

AVISOS

A antena não deve ser introduzida nas tomadas eléctricas.

* QUAISQUER ALTERAÇÕES OU MODIFICAÇÕES FEITAS SEM A APROVAÇÃO DO FABRICANTE PODERÃO ANULAR O DIREITO DO UTILIZADOR A UTILIZAR ESTE BRINQUEDO.

INTERFERÊNCIA DE RÁDIO: o comportamento irregular ou a perda do controlo do veículo poderá resultar da proximidade a fios de alta tensão, transformadores de alta tensão, determinados tipos de edifícios, paredes de betão ou espaços estreitos, nos quais os SINAIS DE RÁDIO do transmissor POSSAM SER DIFUNDIDOS, dificultando assim a capacidade do veículo de receber um BOM SINAL DE RÁDIO. Em caso de comportamento irregular ou perda de controlo, MOVER PARA OUTRA ÁREA.

Haverá INTERFERÊNCIA se OUTRO veículo controlado por rádio ou um rádio CB estiver a ser utilizado nas proximidades na mesma FREQUÊNCIA.

RU СТАНДАРТЫ И СЕРТИФИКАТ СООТВЕТСТВИЯ

1- Компания Spin Master International SARL настоящим заявляет, что данная игрушка соответствует основным требованиям и другим релевантным положениям Директивы 1999/5/EC. Копию декларации соответствия можно получить, отправив запрос на адрес customercare@spinmaster.com или обратившись по адресу Spin Master International S.A.R.L., 16 Avenue Pasteur, L-2310, Luxembourg.

2- Игрушка предназначена только для использования в помещении.

ПРАВИЛА БЕЗОПАСНОСТИ

Выберите БЕЗОПАСНОЕ место для запуска игрушки. Не приводите игрушку в движение на улице. Не используйте игрушку на ПЕСКЕ или на земле, так как это может ухудшить ее управляемость. Внимательно осмотрите участок, в пределах которого будет двигаться игрушка, и устраните препятствия.

Радиоантенны игрушки и передатчика требуют осторожного обращения. Не оставляйте игрушку рядом с источником ТЕПЛА или под воздействием яркого СОЛНЕЧНОГО СВЕТА на долгое время.

Не оставляйте игрушку и передатчик НА УЛИЦЕ НА НОЧЬ. НОЧНАЯ ВЛАЖНОСТЬ МОЖЕТ ПОВРЕДИТЬ ВНУТРЕННИЙ МЕХАНИЗМ.

ОСТОРОЖНО

Запрещается вставлять антенну в розетку.

* ЛЮБЫЕ ИЗМЕНЕНИЯ И МОДИФИКАЦИИ, ОСУЩЕСТВЛЕННЫЕ БЕЗ УТВЕРЖДЕНИЯ ПРОИЗВОДИТЕЛЯ, ЛИШАЮТ ПОЛЬЗОВАТЕЛЯ ПРАВА НА ИСПОЛЬЗОВАНИЕ ДАННОЙ ИГРУШКИ.

РАДИОПОМЕХИ. Необычное поведение игрушки или потери управления может возникнуть из-за приближения к высоковольтным проводам, трансформаторам высокого напряжения, определенным типам сооружений, бетонным стенам или узким местам. В этих зонах РАДИОСИГНАЛЫ, поступающие от передатчика, МОГУТ РАССЕИВАТЬСЯ, что затрудняет передачу РАДИОСИГНАЛА СООТВЕТСТВУЮЩЕЙ МОЩНОСТИ на приемник игрушки. В случае подобного поведения игрушки или потери управления ПЕРЕЙДИТЕ НА ДРУГОЙ УЧАСТОК ИГРОВОЙ ЗОНЫ.

Если в непосредственной близости на той же самой ЧАСТОТЕ работает ДРУГАЯ радиоуправляемая машинка или СВ-радиосвязь, это может вызвать ПОМЕХИ.

TABLE OF CONTENTS/SOMMAIRE

ÍNDICE / INHALTSVERZEICHNIS / INHOUD / INDICE / ÍNDICE / СОДЕРЖАНИЕ



EN: 297 parts, 1 RC chassis, 3 real tools, 1 sticker sheet, 1 remote control, 1 instruction sheet for 1 model.
FR : 297 pièces, 1 châssis R/C, 3 vrais outils, 1 feuillet d'autocollants, 1 radiocommande, 1 notice de montage pour 1 modèle.
ES: 297 piezas, 1 chasis RC, 3 herramientas reales, 1 hoja de calcomanías, 1 control remoto, 1 guía de instrucciones para 1 modelo.
DE: 297 Teile, 1 RC-Fahrgestell, 3 echte Werkzeuge, 1 Bogen mit Aufklebern, 1 Fernsteuerung, 1 Bauanleitung für 1 Modell.
NL: 297 onderdelen, 1 RC-chassis, 3 stuks gereedschap, 1 stickervel, 1 afstandsbediening, 1 bouw instructie voor 1 model.
IT: 297 pezzi, 1 telaio radiocomandato, 3 attrezzi, 1 foglio di adesivi, 1 radiocomando, 1 guida per l'uso per 1 modello.
PT: 297 peças, 1 chassis RC, 3 ferramentas reais, 1 cartela de adesivos, 1 controlo remoto, 1 folha de instruções para 1 modelo.
RU: 297 деталей, 1 радиоуправляемое шасси, 3 настоящих инструмента, 1 лист с наклейками, 1 устройство дистанционного управления, 1 инструкция по сборке 1 модели.

CANADIAN Class B statement: This device complies with Industry Canada Licence-exempt RSS-210. Operation is subject to the following two conditions: (1) this device may not cause interference, and (2) this device must accept any interference, including interference that may cause undesired operation of the device.

Déclaration CANADIENNE classe B : Le présent appareil est conforme au CNR-210 d'Industrie Canada applicable aux appareils radio exempts de licence. L'utilisation est autorisée aux deux conditions suivantes : (1) l'appareil ne doit pas produire de brouillage, et (2) l'appareil doit accepter tout brouillage radioélectrique subi, même si le brouillage est susceptible d'en compromettre le fonctionnement.

CAN ICES-3(B)/NMB-3(B)

FCC Statement: This device complies with Part 15 of the FCC rules. Operation is subject to the following two conditions:

(1) This device may not cause harmful interference, and (2) This device must accept any interference received, including interference that may cause undesired operation.

This equipment has been tested and found to comply with the limits for Class B digital devices pursuant to Part 15 of the FCC rules. These limits are designed to provide reasonable protection against harmful interference to radio communications. This equipment generates, uses and can radiate radio frequency energy and, if not installed and used in accordance with the instruction, may cause harmful interference to radio communication. However, there is no guarantee that interference will not occur in a particular installation. If this toy does cause interference to radio or television reception (you can check this by turning the toy off and on while listening for the interference), one or more of the following measures may be useful:

- Reorient or relocate the receiving antenna.
- Increase the separation between the toy and the radio or the TV.
- Consult the dealer or an experienced TV-radio technician for help.

NOTE: Changes, adjustments or modifications to this unit, including but not limited to, replacement of any transmitter component (crystal, semiconductor, etc) could result in a violation of FCC rules under part 15 and/or 95 and must be expressly approved by Spin Master Ltd. or they could void the user's authority to operate the equipment.

Déclaration FCC : Cet appareil est conforme à l'article 15 de la réglementation de la FCC. Son utilisation est soumise aux deux conditions suivantes :

(1) Cet appareil ne doit pas causer d'interférences nuisibles, et (2) Cet appareil doit tolérer toutes les interférences reçues, y compris celles pouvant entraîner un fonctionnement indésirable.

Cet équipement a été testé et jugé conforme aux limites de la classe B pour les équipements numériques en vertu de l'article 15 de la réglementation de la FCC. Ces limites ont été instaurées pour assurer une protection raisonnable contre toute interférence nuisible avec les communications radios. Cet équipement génère, utilise et peut émettre de l'énergie de fréquence radio. S'il n'est pas installé et utilisé selon le mode d'emploi, il peut causer des interférences nuisibles aux communications radios. Cependant, selon l'installation, des interférences peuvent être constatées. Si ce jouet cause des interférences à la réception radio ou télévisée (ce qui est vérifiable en l'éteignant, puis en le rallumant tout en écoutant s'il y a des interférences), suivre une ou plusieurs des recommandations suivantes :

- Réorienter ou déplacer l'antenne réceptrice.
- Augmenter la distance entre le jouet et la radio ou la télévision.
- Consulter le revendeur ou demander l'aide d'un technicien radio/TV. expérimenté.

REMARQUE : tout changement, réglage ou modification de cet appareil, incluant mais ne se limitant pas au remplacement de tout composant du transmetteur (cristal, semi-conducteur, etc.), pourrait constituer une violation de l'article 15 et/ou 95 de la réglementation de la FCC, et doit être expressément approuvé par Spin Master Ltd., sous peine d'entraîner l'annulation du droit de l'utilisateur d'exploiter l'équipement.

Declaración de la FCC: Este aparato cumple con el artículo 15 de las normas de la FCC.

El funcionamiento está sujeto a las dos siguientes condiciones: (1) Este aparato no debe causar interferencias perjudiciales, y (2) Este aparato debe aceptar cualquier interferencia recibida, incluidas las que podrían causar un funcionamiento no deseado.

Este equipo se sometió a las pruebas debidas y se comprobó que cumple con los requisitos específicos para aparatos digitales de clase B en conformidad con el artículo 15 de las normas de la FCC. Estos requisitos están diseñados para proporcionar protección razonable contra interferencias perjudiciales en las comunicaciones por radio. Este juguete genera, utiliza y puede emitir energía de radiofrecuencia. Si no se instala y se utiliza de acuerdo con la guía de instrucciones, puede causar interferencias en las comunicaciones por radio. Sin embargo, en función de la instalación, pueden ocurrir interferencias. Si este juguete ocasiona interferencias perjudiciales en la recepción radio o televisiva (lo cual se puede comprobar encendiendo y apagando el juguete mientras se escucha la interferencia), seguir una o varias de las siguientes recomendaciones:

- Volver a orientar o ubicar la antena receptora.
- Aumentar la distancia entre el juguete y la radio o el televisor.
- Consultar al distribuidor o a un técnico especializado en radio y televisión.



NOTA: Los cambios, ajustes o modificaciones realizados sobre este aparato, incluidos pero no limitados al cambio de cualquier componente del transmisor (emisor de cristal, semiconductor, etc.) podrían constituir una violación del artículo 15 y/o 95 de las normas de la FCC y deberían ser expresamente aprobados por Spin Master Ltd., de lo contrario quedaría inválida la autoridad del usuario para usar el equipo.



1



-  **S3** | 12 mm | **x4**
1/2"
-  **x4**
-  **A338x4**
-  **x2**
-  **x2**
-  **x1**

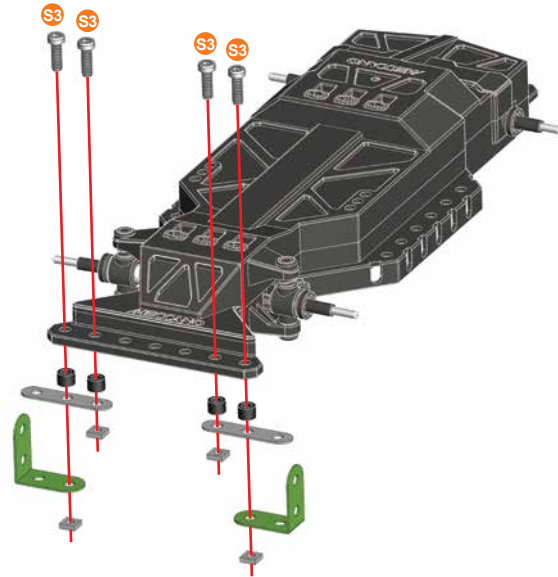
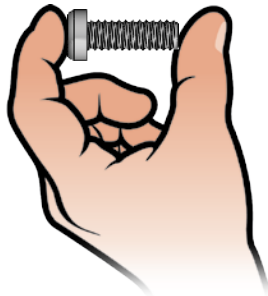

-  **A338**
-  **x1**
-  **S3**





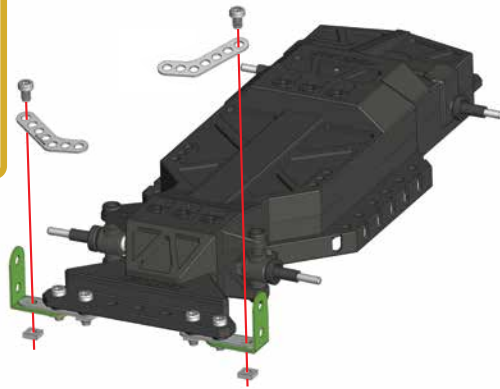

2

	5.8 mm 15/64"	x2
		x2
		x2



	1:1
-----------------------------------------------------------------------------------	------------

**3**

	5.8 mm 15/64"	x2
		x2
		x1
		x2

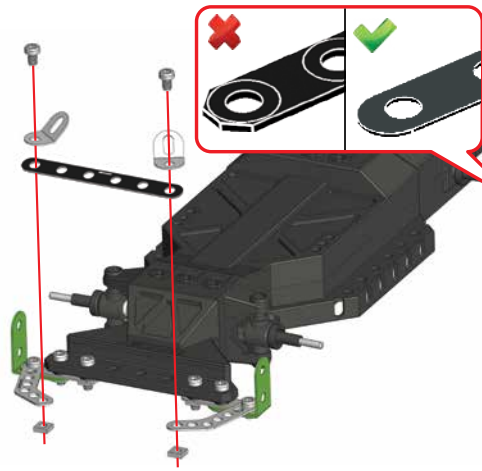

	1:1
-------------------------------------------------------------------------------------	------------

**4**

	5.8 mm 15/64"	x2
		x2
		x2

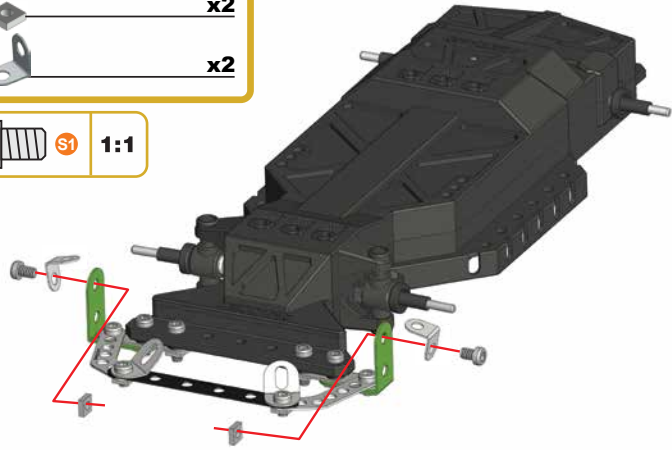
	1:1
-----------------------------------------------------------------------------------	------------

**5**

	5.8 mm 15/64"	x1
	9.5 mm 3/8"	x1
		x2
		x2
		x1
		x1
		x1

	S2	1:1
	S1	

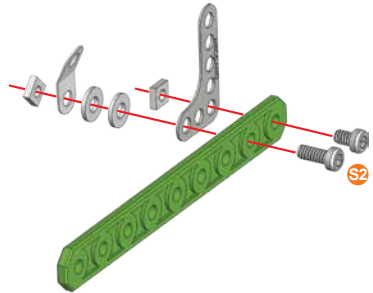

6

④+⑤+

	14.7 mm 37/64"	x2
		x2
		A238x2
		x2

	B1	
	A238	
		1:1

7

	5.8 mm 15/64"	x2
		x2
		x1

	S1	1:1
--	----	-----

8

	5.8 mm 15/64"	x1
		x1
		x1





S1 1:1

9

	5.8 mm 15/64"	x1
		x1
		x1
		x1
		x1

S1 1:1





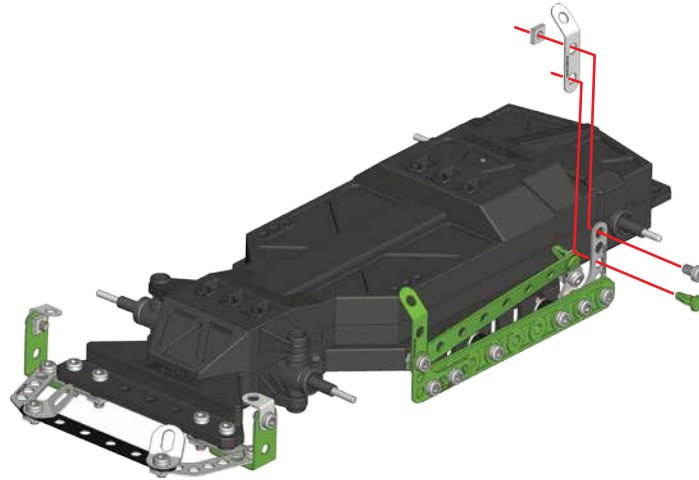

10

-  **S1** | 5.8 mm | **x1**
15/64"
-  **x1**
-  **x1**
-  **x1**

-  **S1** | **1:1**



11



-  **S1** | 5.8 mm | **x1**
15/64"
-  **S2** | 9.5 mm | **x1**
3/8"
-  **x2**
-  **x2**
-  **x1**
-  **x1**
-  **x1**

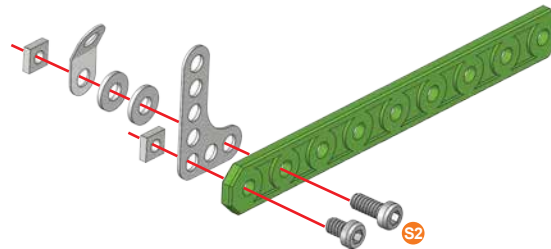

-  **S2**
-  **S1**
- 1:1**



12

10+11+

-  | 14.7 mm | **x2**
37/64" | **x2**
-  | **A238x2**
-  | **x2**

-  | **B1**
-  | **A238**
- 1:1**

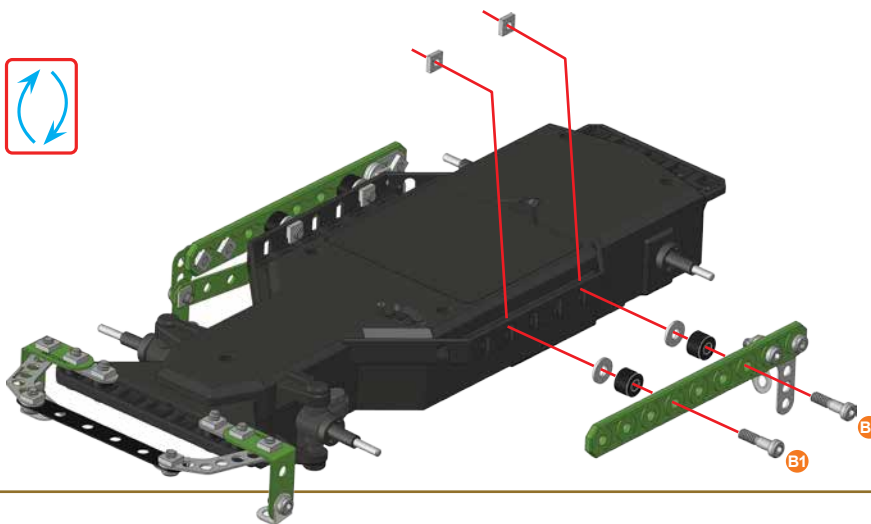

13

-  | 5.8 mm | **x2**
15/64" | **x2**
-  | **x1**

-  | **1:1**

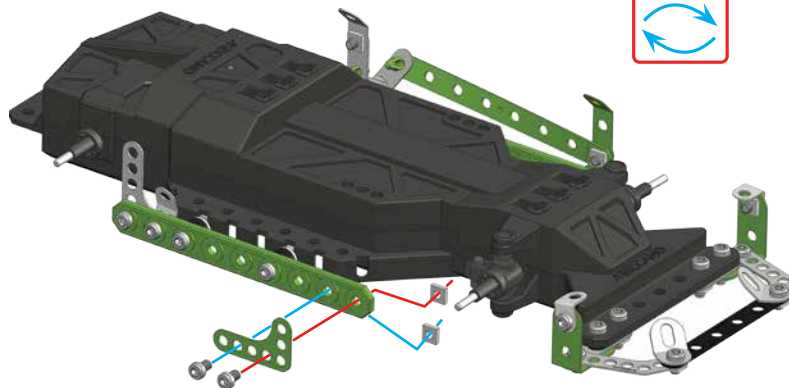



- 14**
- 5.8 mm | 15/64" | x1
 - x1
 - x1

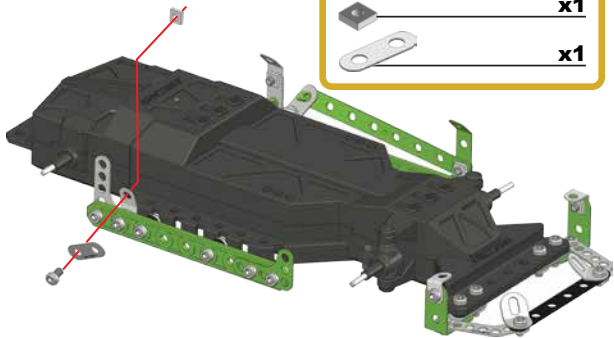

- 15**
- 5.8 mm | 15/64" | x1
 - x1
 - x1
 - x1
 - x1

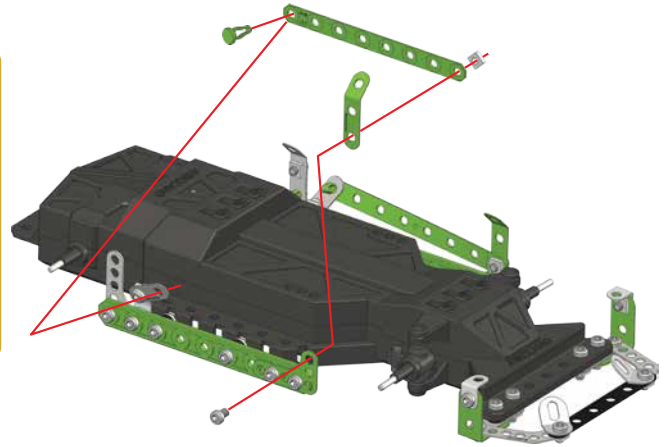

- 16**
- 5.8 mm | 15/64" | x1
 - x1
 - x1
 - x1

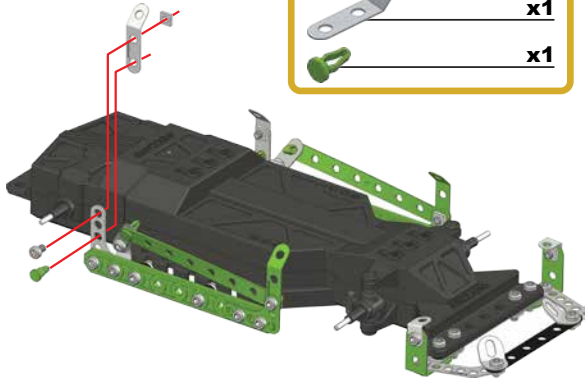

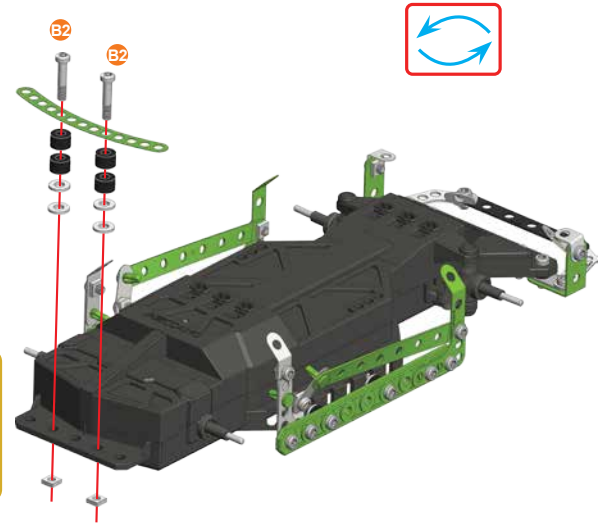

- 17**
- 19 mm | 3/4" | x2
 - x2
 - A238x4
 - x4
 - x1

- A238
- S2 | 1:1







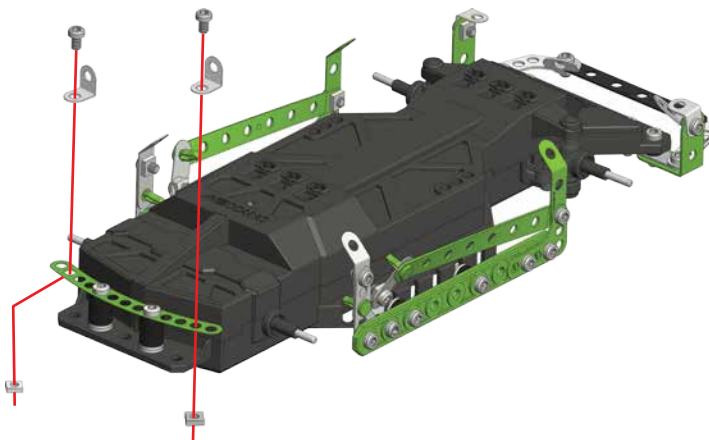

18

-  **S1** | 5,8 mm | **x2**
15/64"
-  **x2**
-  **x2**





-  **S1** | **1:1**



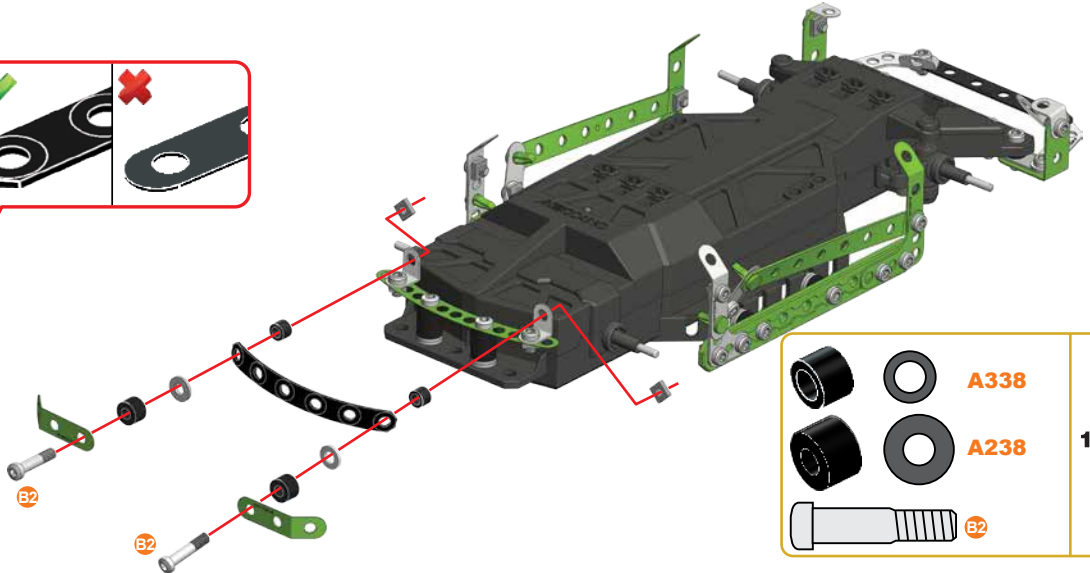
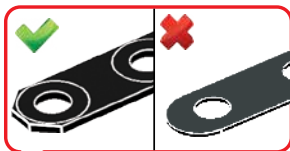



19

-  **B2** | 19 mm | **x2**
3/4"
-  **x2**
-  **A338x2**
-  **A238x2**
-  **x2**
-  **x2**
-  **x1**



-  **A338**
-  **x2**
-  **A238**
-  **B2** | **1:1**





20

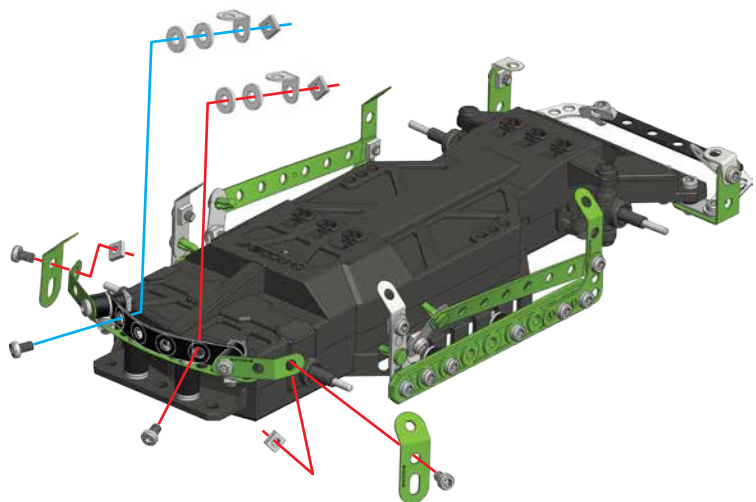

	S1 5.8 mm x4 15/64"
	x4
	x4
	x2
	x2

	S1 1:1
-----------------------------------------------------------------------------------	------------------------



21

	S2 9.5 mm x2 3/8"
	x2
	A338x2
	x2
	x1

	A338
	S2
1:1	

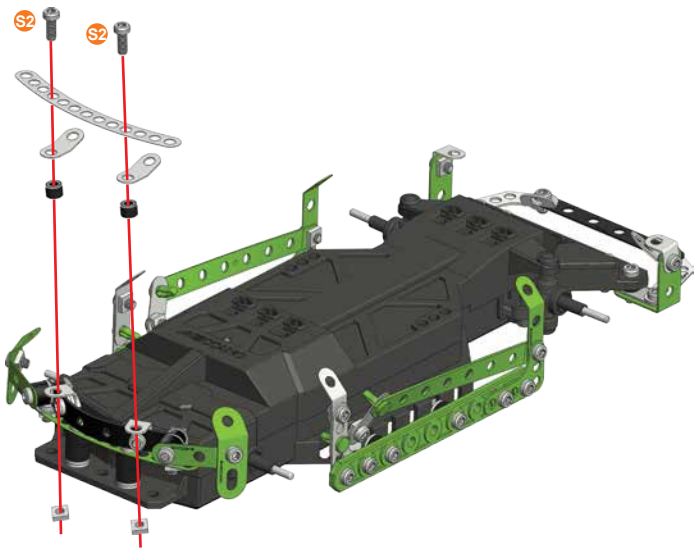

22

	S1	5,8 mm 15/64"	x1
	S2	9,5 mm 3/8"	x1
			x2
			x2
			x1
			x1
			x1

	S1	1:1
	S2	

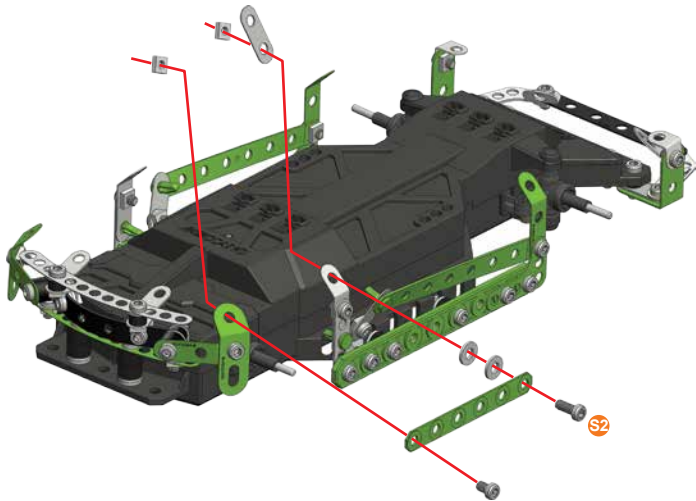







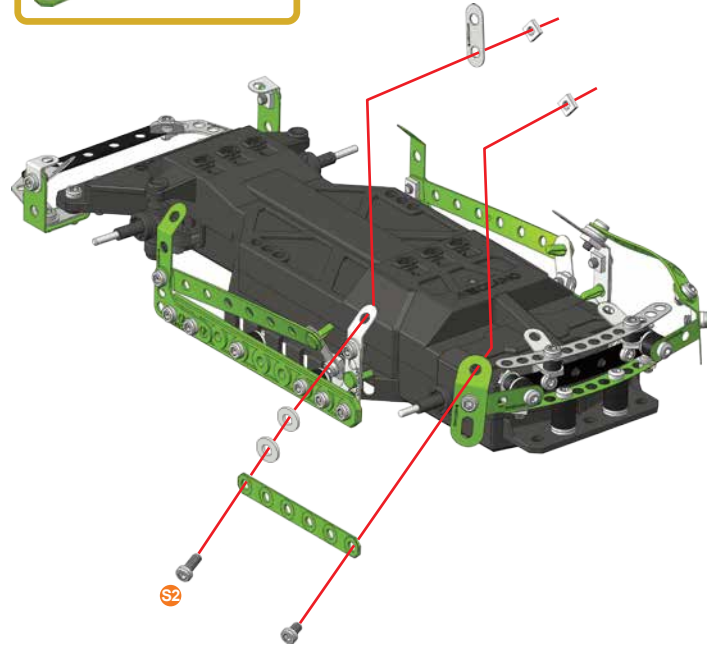
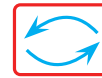

23

	S1	5,8 mm 15/64"	x1
	S2	9,5 mm 3/8"	x1
			x2
			x2
			x1
			x1
			x1

	S1	1:1
	S2	







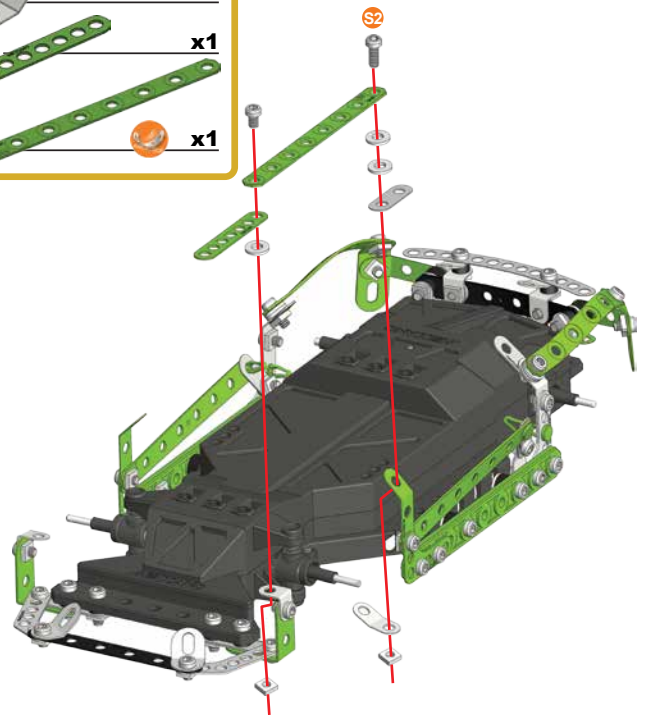
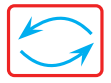
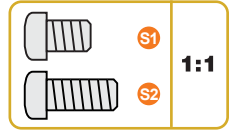



24

-  **S1** 5,8 mm | 15/64" | **x1**
-  **S2** 9,5 mm | 3/8" | **x1**
-  **x2**
-  **x3**
-  **x1**
-  **x1**
-  **x1**
-  **x1**
-  **x1**







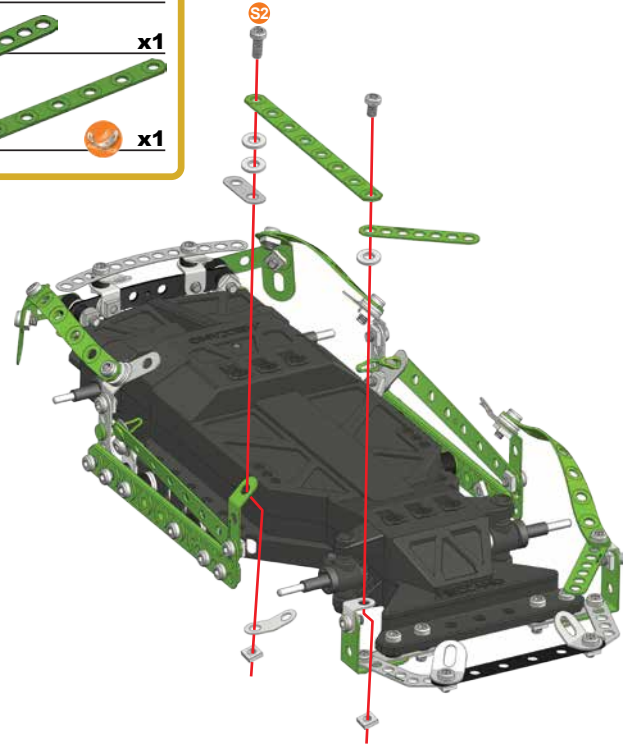
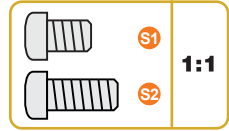

25

-  **S1** 5,8 mm | 15/64" | **x1**
-  **S2** 9,5 mm | 3/8" | **x1**
-  **x2**
-  **x3**
-  **x1**
-  **x1**
-  **x1**
-  **x1**
-  **x1**



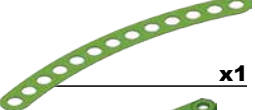
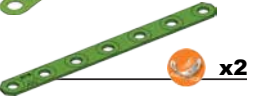

26

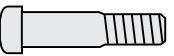
-  **B2** | 19 mm | **x2**
3/4"
-  **x2**
-  **x2**
-  **A338x4**
-  **x1**
-  **x2**

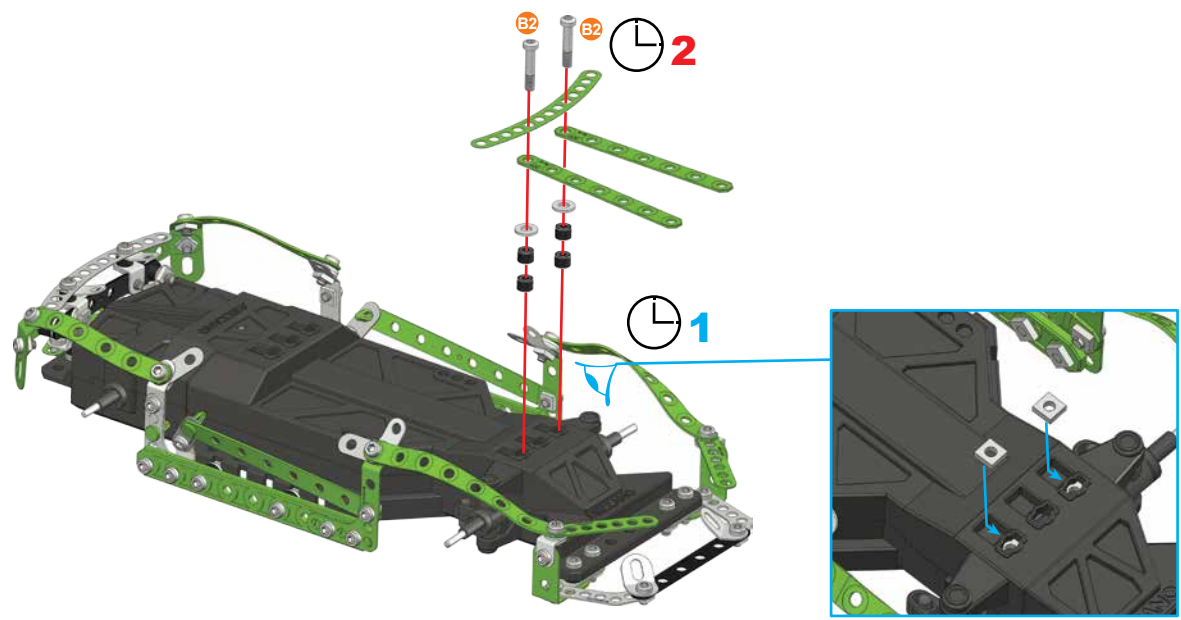
-  **A338**
-  **1:1**
-  **B2**







27

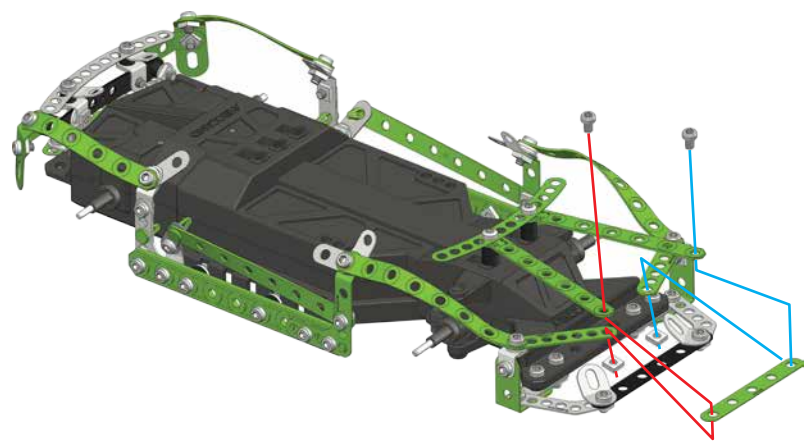



-  **S1** | 5.8 mm | **x2**
15/64"
-  **x2**
-  **x1**

-  **S1** | **1:1**

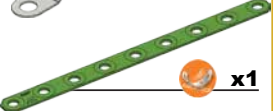





28

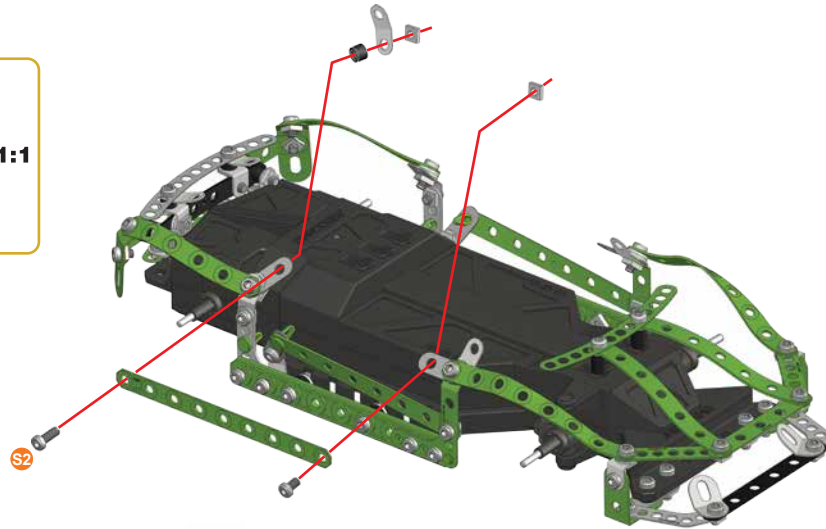



-  **S1** | 5,8 mm | **x1**
15/64"
-  **S2** | 9,5 mm | **x1**
3/8"
-  **x2**
-  **A338x1**
-  **x1**
-  **x1**

-  **S1**
-  **S2**
- 1:1**
-  **A338**
- 

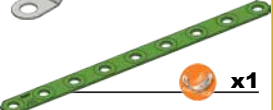

29

-  **S1** | 5,8 mm | **x1**
15/64"
-  **S2** | 9,5 mm | **x1**
3/8"
-  **x2**
-  **A338x1**
-  **x1**
-  **x1**

-  **S1**
-  **S2**
- 1:1**
-  **A338**
- 

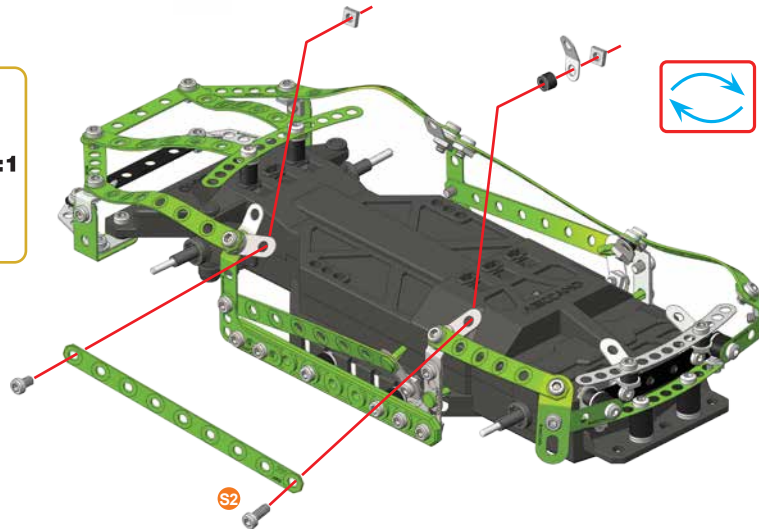

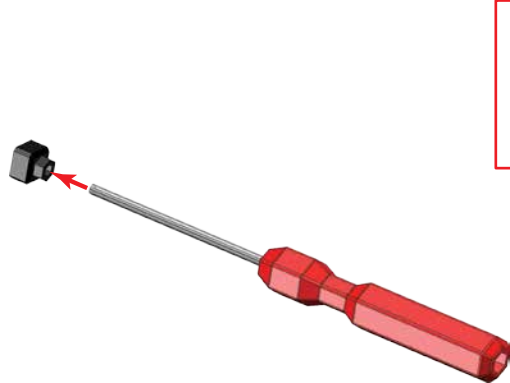
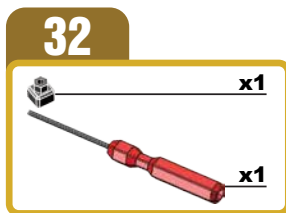
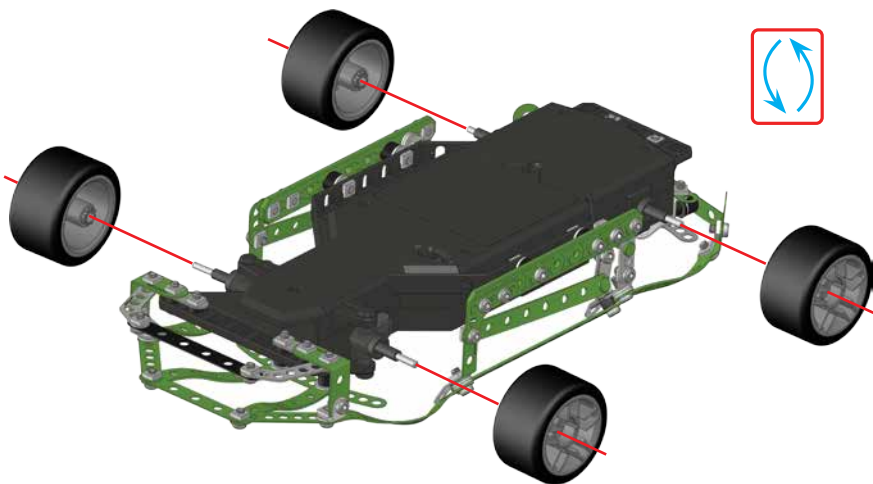
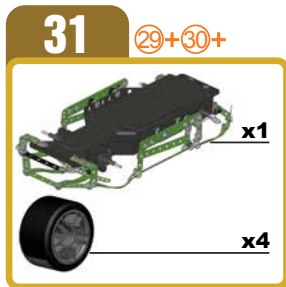
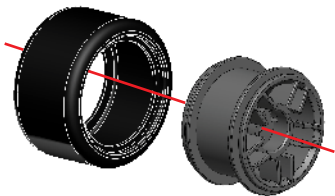
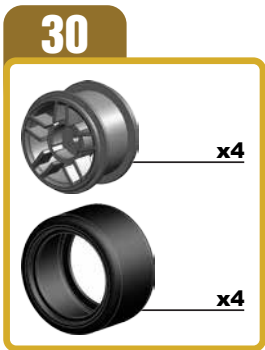

33 ③1+③2+
x2

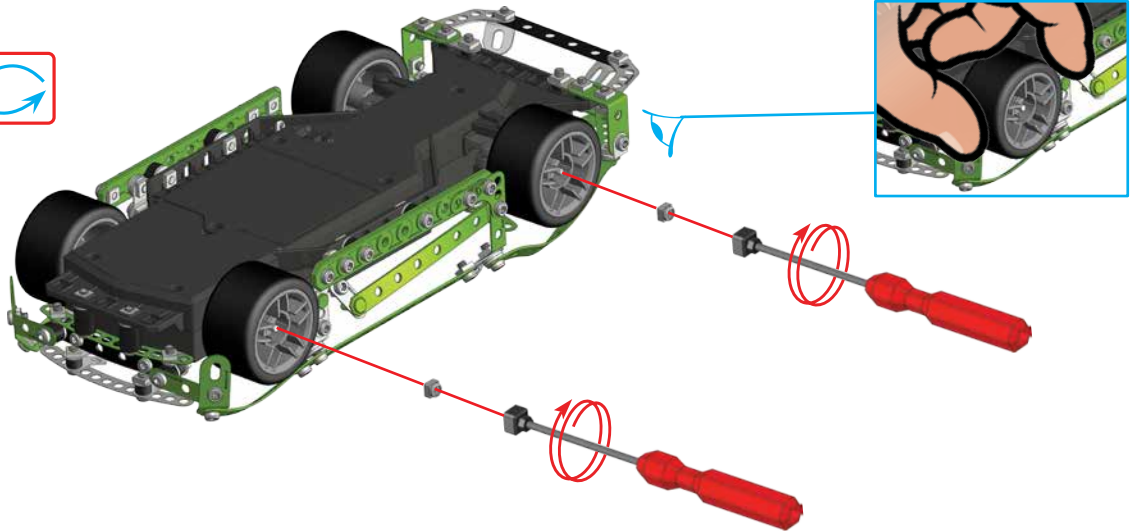
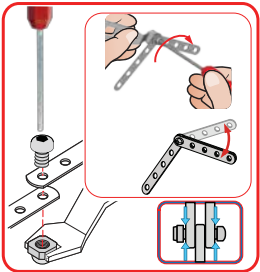

34
x2

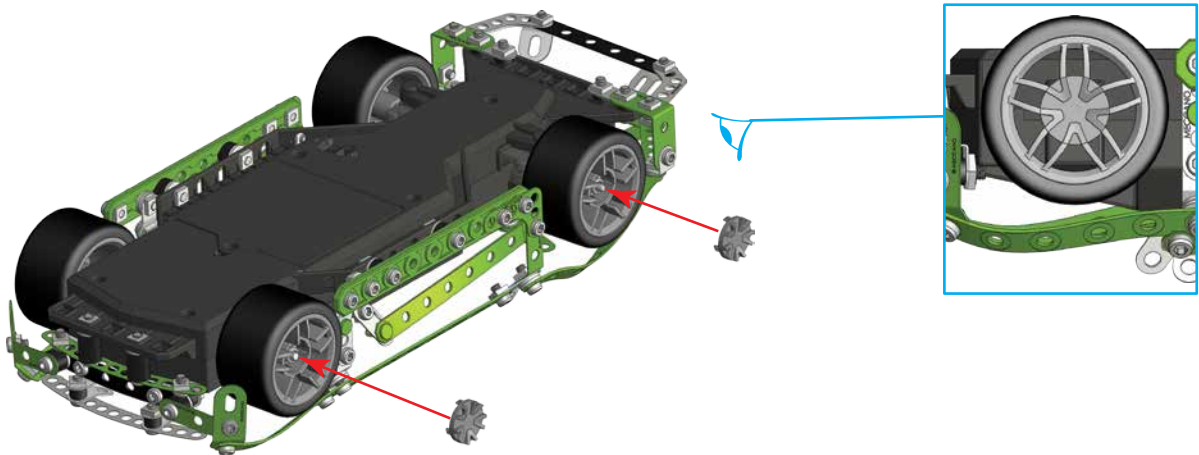

35 ③②+③④+
x2

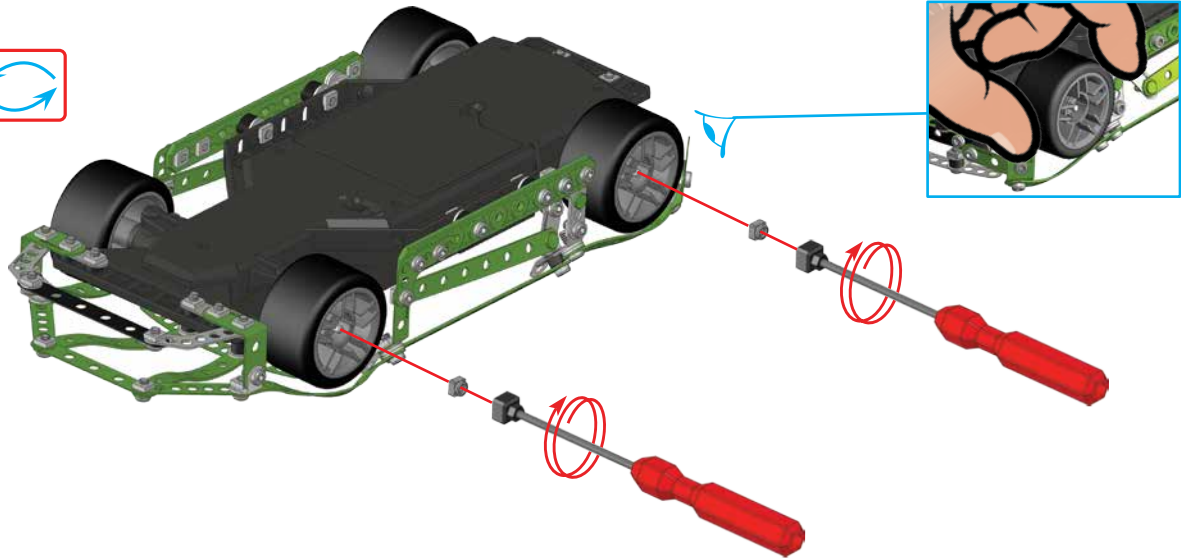
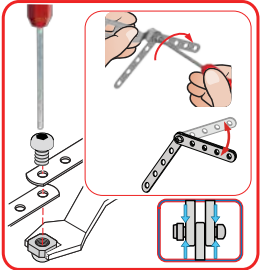

36
x2

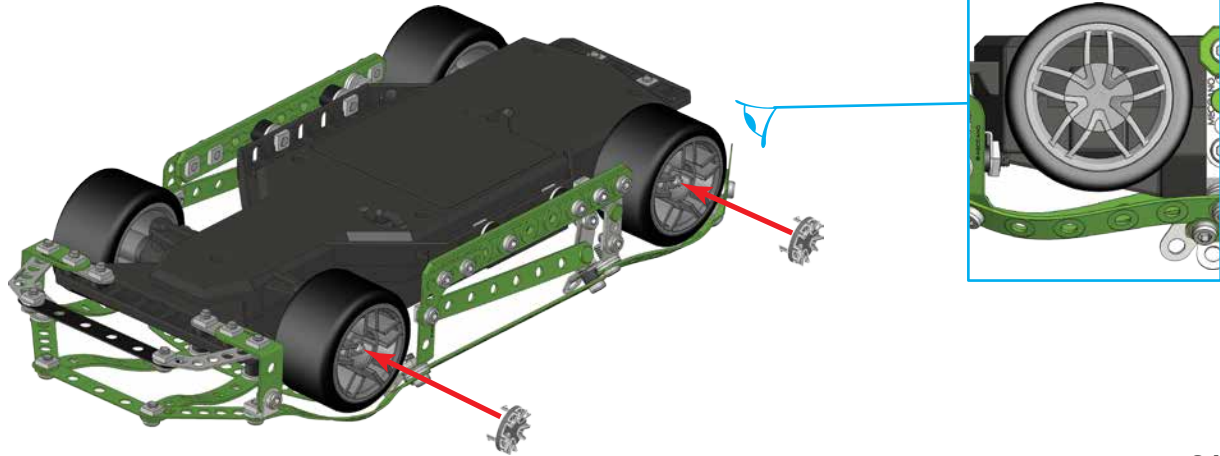

37

- S2** | 9,5 mm | **x1**
3/8"
- B1** | 14,7 mm | **x1**
37/64"
- x2**
- A338x1**
- x1**

- A338**
- S2** | **1:1**
- B1**

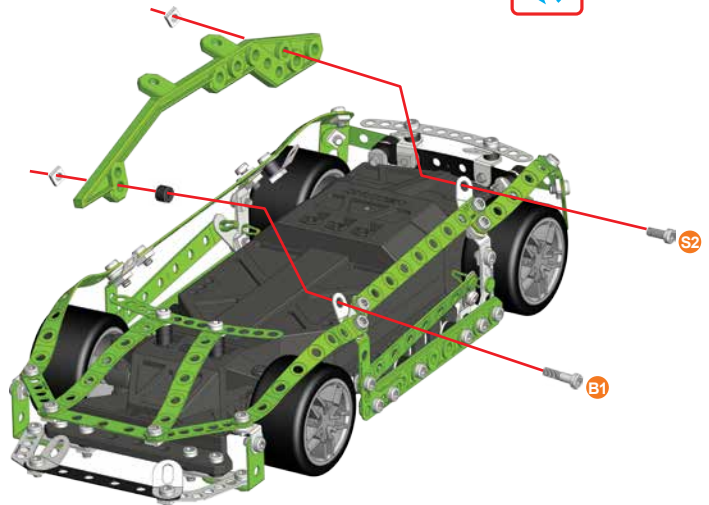



38

- S2** | 9,5 mm | **x1**
3/8"
- B1** | 14,7 mm | **x1**
37/64"
- x2**
- A338x1**
- x1**

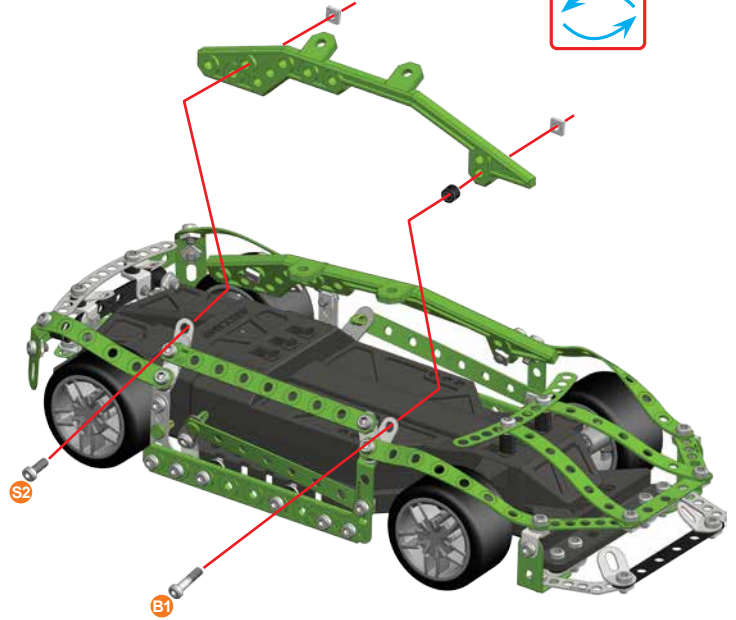
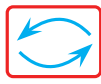
- A338**
- S2** | **1:1**
- B1**





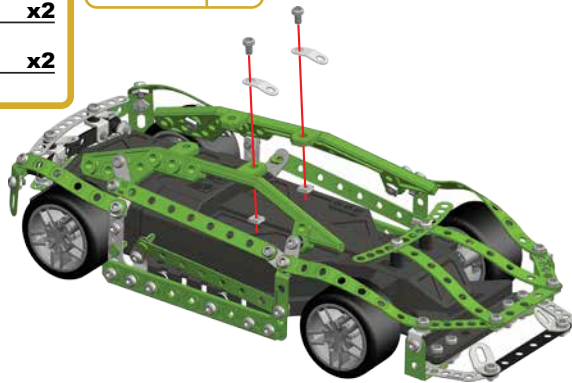

39

-  S1 | 5.8 mm | x2
15/64"
-  x2
-  x2

-  S1 | 1:1





41

-  S1 | 5.8 mm | x2
15/64"
-  x2
-  x1
-  x1

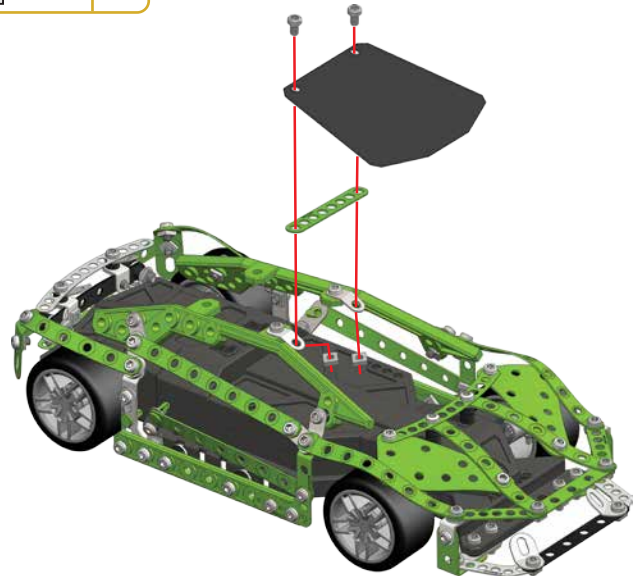
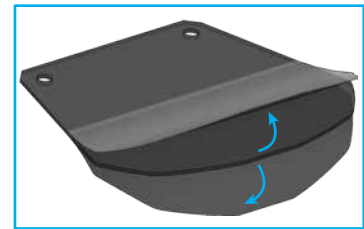
-  S1 | 1:1





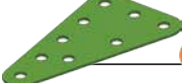



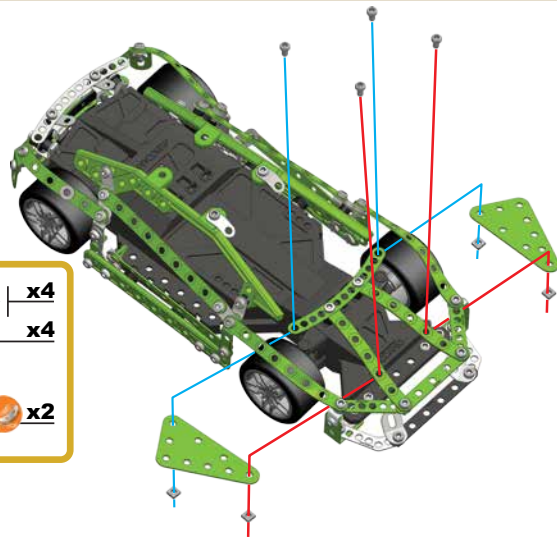

40

-  S1 | 5.8 mm | x4
15/64"
-  x4
-  x2

-  S1 | 1:1



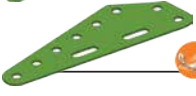

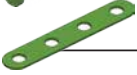





42

		x1			x1
		x1			
		x1			x1
		x1			

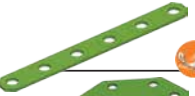
	1:1
-----------------------------------------------------------------------------------	------------

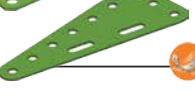

43

		x1			x1
		x1			
		x1			x1
		x1			

	1:1
------------------------------------------------------------------------------------	------------

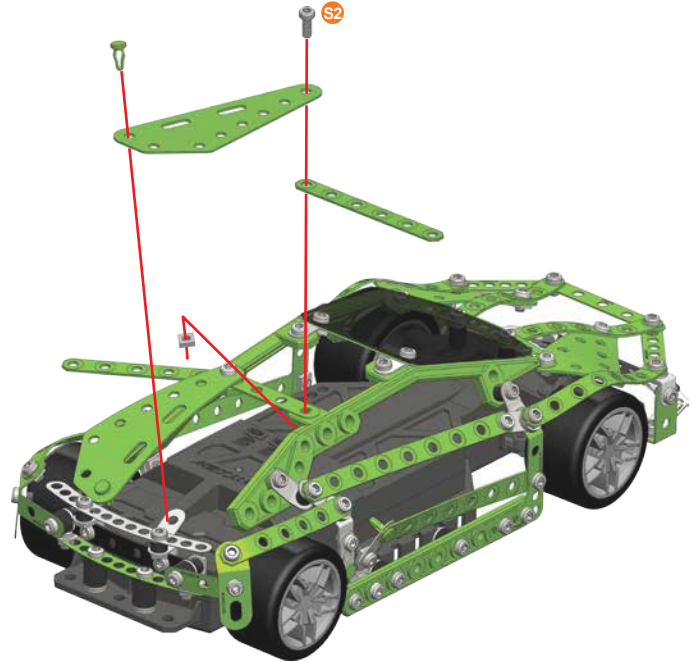

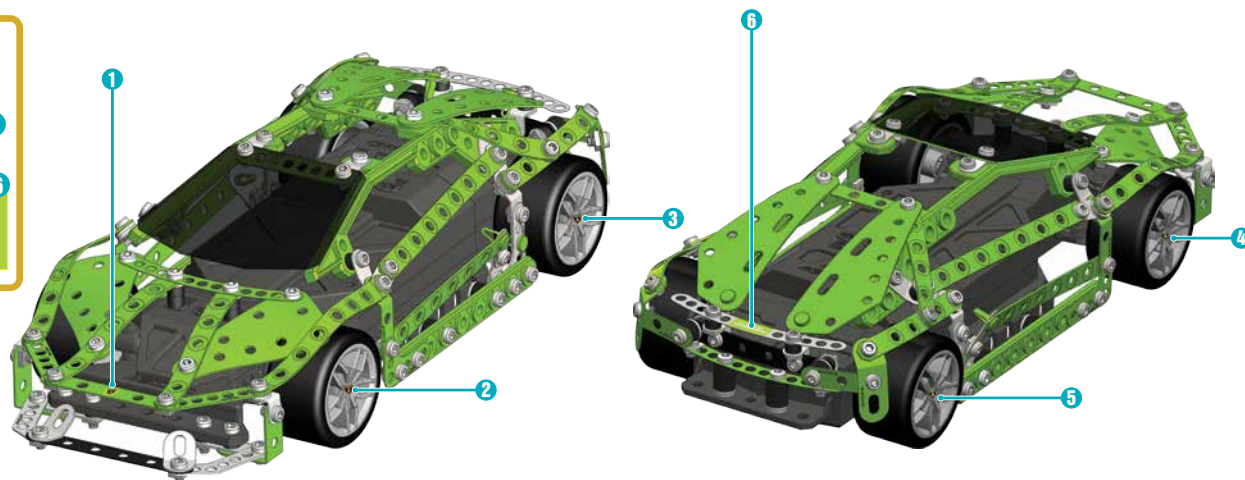
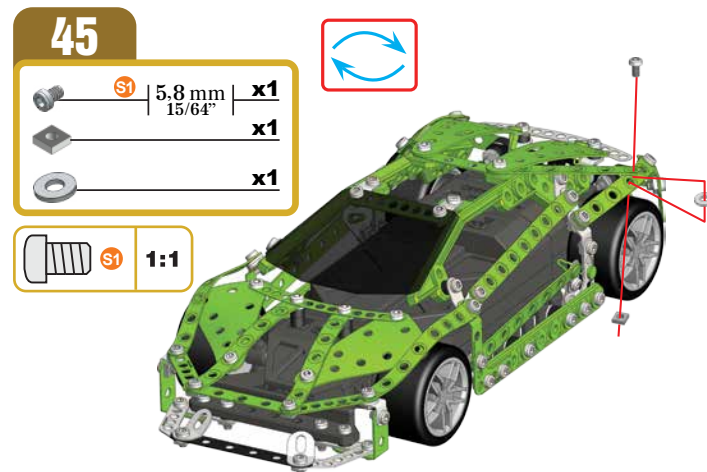
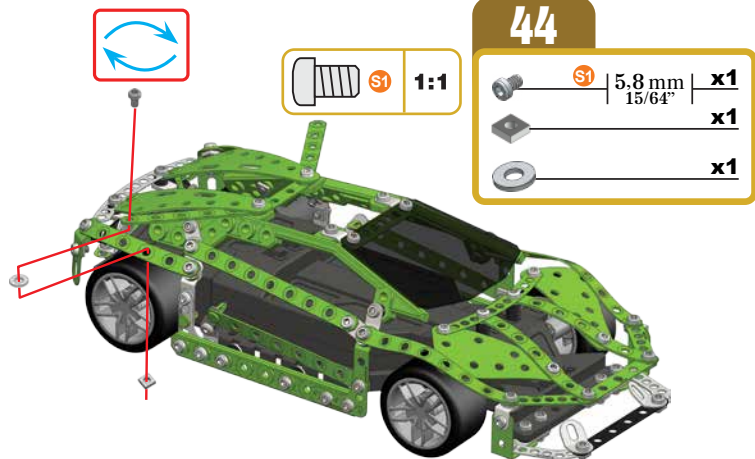

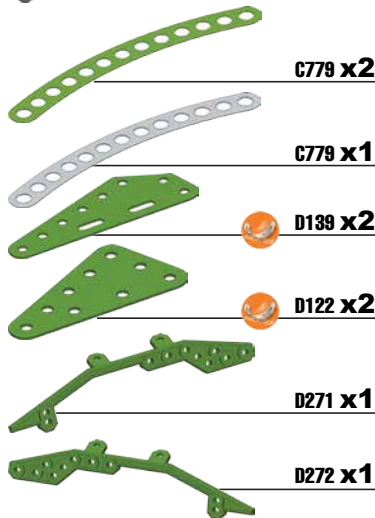
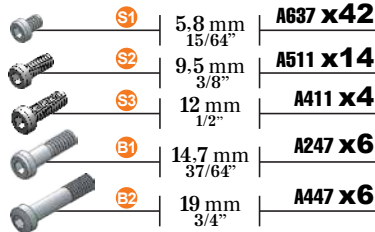
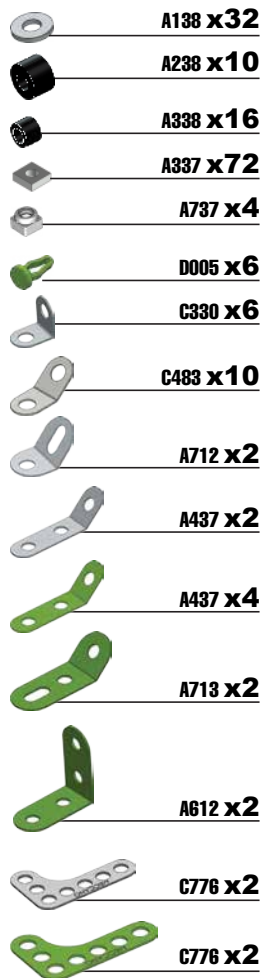



EN When this product has reached the end of its useful life it should not be disposed of with other household waste. The Waste Electrical and Electronic Equipment Regulations require it to be separately collected so that it can be treated using the best available recovery and recycling techniques. This will minimize the impact on the environment and human health from soil and water contamination by any hazardous substances, decrease the resources required to make new products and avoid using up landfill space. Please do your part by keeping this product out of the municipal waste stream! The "wheele bin" symbol means that it should be collected as "waste electrical and electronic equipment". You can return an old product to your retailer when you buy a similar new one. For other options, please contact your local council.

FR Lorsque ce produit arrive en fin de vie, il ne doit pas être jeté avec le reste des déchets ménagers. Conformément à la directive sur les Déchets des équipements électriques et électroniques (DEEE), il doit être collecté séparément afin d'être éliminé selon les meilleures techniques de récupération et de recyclage disponibles. Cette démarche réduit les risques de pollution du sol et des eaux, et permet ainsi de minimiser l'impact de toute substance nocive sur la santé et sur l'environnement. Cela diminue également la quantité de ressources nécessaires à la fabrication de nouveaux produits, et évite la saturation des sites d'enfouissement. Veuillez apporter votre contribution en ne jetant pas ce produit avec les déchets de votre commune. Le symbole de la « poubelle sur roues » signifie que ce produit doit faire l'objet d'une collecte respectant la directive sur les Déchets des équipements électriques et électroniques (DEEE). Vous pouvez également retourner les produits en fin de vie à votre détaillant lors de l'achat d'un produit similaire neuf. Pour plus d'informations, contactez votre commune.

ES Cuando este producto alcance el final de su vida útil, no lo deseches como residuo doméstico. La normativa exige que se recoja de forma separada para que pueda tratarse con las mejores técnicas de recuperación y reciclaje disponibles. De esta forma, se minimizará el impacto que la contaminación del suelo y el agua causada por sustancias peligrosas tiene sobre el medio ambiente y la salud humana, se reducirán los recursos necesarios para fabricar nuevos productos y se evitará la saturación de los vertederos. (Colabora desechando este producto de forma adecuada! El símbolo del contenedor con ruedas significa que debería recogerse como residuo de aparatos eléctricos y electrónicos. Puedes devolver un producto antiguo en tu establecimiento habitual cuando adquieras un producto nuevo similar. Si deseas obtener más información, consulta con las autoridades locales.

DE Ist das Gerät nicht mehr zu gebrauchen, darf es nicht über den Hausmüll entsorgt werden. Die Elektroaltgeräteverordnung (EAG-VO) sieht vor, dass das Gerät separat entsorgt wird, damit es so weit wie möglich recycelt werden kann. Dadurch lassen sich die Menge an umwelt- und gesundheitsschädlichen Substanzen, die über den Boden und das Grundwasser in den menschlichen Nahrungskreislauf gelangen könnten, minimieren, die für die Herstellung neuer Produkte erforderlichen Ressourcen reduzieren und Platz auf Mülldeponien sparen. Leisten Sie bitte Ihren Beitrag dazu, indem Sie das Gerät nicht über den Hausmüll entsorgen. Das Mülltonnen-Symbol bedeutet, dass das Gerät gemäß den Vorschriften für Elektro- und Elektronikgeräte entsorgt werden muss. Alte Geräte können oft beim Kauf eines neuen, ähnlichen Geräts im Einzelhandel zurückgegeben werden. Weitere Entsorgungsmöglichkeiten erfragen Sie bitte bei Ihrer Gemeindeverwaltung.

NL Wanneer dit product het einde van zijn levensduur heeft bereikt, mag het niet samen met ander huishoudelijk afval worden weggegooid. Volgens de wet moet het afzonderlijk worden ingezameld zodat het kan worden behandeld met de best beschikbare recycletechnieken. Op deze manier wordt de invloed op het milieu en de menselijke gezondheid van grond- en watervervuiling door gevaarlijke stoffen geminimaliseerd, hoewel er minder bronnen te worden gebruikt om nieuwe producten te maken en raken stortplaatsen minder snel vol. Draag je steentje bij door dit product uit de gemeentelijke afvalstroom te houden! Het afvalcontainersymbool betekent dat het product moet worden ingezameld als elektrische en elektronische afvalapparatuur. Je kunt een oud product inruilen bij de detailhandelaar wanneer je een vergelijkbaar nieuw product koopt. Neem voor andere opties contact op met de gemeente.

IT Il simbolo del cassonetto barrato riportato sull'apparechiatura indica che il prodotto alla fine della propria vita utile deve essere raccolto separatamente dagli altri rifiuti. L'utente dovrà, pertanto, conferire l'apparechiatura integra dei componenti essenziali giunta a fine vita agli idonei centri di raccolta differenziata dei rifiuti elettrici ed elettronici, oppure riconsegnarla al rivenditore al momento dell'acquisto di una nuova apparecchiatura di tipo equivalente, in ragione di uno a uno. L'adeguata raccolta differenziata per l'avvio successivo dell'apparechiatura dimessa al riciclaggio, al trattamento e allo smaltimento ambientale compatibile contribuisce ad evitare possibili effetti negativi sull'ambiente e sulla salute e favorisce il riciclo dei materiali di cui è composta l'apparechiatura. Lo smaltimento abusivo del prodotto da parte dell'utente comporta l'applicazione delle sanzioni amministrative di cui al D.Lgs. n.152/2006 (parte 4 art.255).

PT Quando este produto alcançar o fim da sua vida útil não deverá ser eliminado junto dos resíduos domésticos. Por lei, deverá ser recolhido em separado para posterior tratamento usando as melhores técnicas de recuperação e reciclagem disponíveis. Desta forma, minimiza-se o impacto no ambiente e saúde humana da contaminação do solo e água por substâncias perigosas, diminui-se os recursos necessários para fabricar novos produtos e evita-se o esgotamento do espaço em aterros sanitários. Colaborar mantendo este produto fora da rede de recolha de resíduos urbanos! O símbolo de "caixote de lixo móvel" significa que o produto deverá ser recolhido como "resíduo de equipamento eléctrico e electrónico". Pode devolver um produto antigo à loja quando compra outro semelhante. Contacte as autoridades locais relativamente à disponibilidade de outras opções.

RU По окончании срока эксплуатации не выбрасывайте игрушку вместе с бытовыми отходами. Согласно закону об утилизации электрических и электронных устройств ее необходимо утилизировать отдельным способом, с использованием наиболее подходящих технологий утилизации и переработки. Это позволит снизить негативные последствия для окружающей среды и здоровья человека, уменьшит загрязнение воды и почвы опасными веществами, а также снизит количество ресурсов, необходимых для изготовления новых игрушек и сократит объем мусора на городских свалках. Вынесите свой вклад, сохранив город чистым. Знаком с изображением перечеркнутой корзины означает, что игрушку следует утилизировать согласно закону об утилизации электрических и электронных устройств. При покупке новой игрушки вы можете вернуть старую в магазин. Чтобы узнать о других возможных вариантах утилизации, обратитесь в местную перерабатывающую организацию.

EN Battery Safety Information: Requires 4 x AA /LR6 and 3xAAA/LR03 1.5V alkaline batteries (not included). Batteries are small objects. Replacement of batteries must be done by adults. Follow the polarity (+/-) diagram in the battery compartment. Promptly remove dead batteries from the toy. Dispose of used batteries properly. Remove batteries for prolonged storage. Only batteries of the same or equivalent type as recommended are to be used. DO NOT incinerate used batteries. DO NOT dispose of batteries in fire, as batteries may explode or leak. DO NOT mix old and new batteries or types of batteries (i.e. alkaline/standard). DO NOT use rechargeable batteries. DO NOT recharge non-rechargeable batteries. DO NOT short-circuit the supply terminals.

FR Informations de sécurité relatives aux piles : Fonctionner avec 4 piles AA /LR6 et 3 piles alcalines AAA/LR03 1,5 V (non fournies). Les piles sont des objets de petite taille. Le remplacement des piles doit être effectué par un adulte. Respecter le schéma de polarité (+/-) figurant sur le compartiment des piles. Retirer immédiatement toute pile usagée du jouet. Les piles usagées doivent être jetées conformément aux réglementations en vigueur. Retirer les piles lorsque le produit n'est pas utilisé pendant une période prolongée. Utiliser uniquement des piles identiques ou équivalentes à celles recommandées. NE PAS incinérer les piles usagées. NE PAS jeter au feu des piles usagées, car elles risqueraient d'exploser ou de fuir. NE PAS combiner des piles neuves et usagées, ou des piles de types différents (alcalines et standard, par exemple). NE PAS utiliser de piles rechargeables. NE PAS recharger de piles non-rechargeables. NE PAS court-circuiter les bornes d'alimentation.

ES Información importante sobre las pilas: Necesita 4 pilas alcalinas AA/LR6 y 3 AAA/LR03 de 1,5 V (no incluidas). Las pilas son objetos pequeños. Las pilas deben ser sustituidas por un adulto. Sigue el esquema de polaridad (+/-) que aparece en el compartimento de las pilas. Retire cuanto antes las pilas gastadas del juguete. Deseche las pilas usadas de manera apropiada. Refire las pilas si se va a guardar el juguete durante un tiempo prolongado. Utilice únicamente pilas del tipo recomendado o de un tipo equivalente. NO incinere las pilas usadas. NO arroje las pilas al fuego, ya que podrían explotar o desprender productos químicos. NO mezcle pilas nuevas con pilas usadas, ni distintas tipos de pilas (p. ej., alcalinas y normales). NO use pilas recargables. NO recargue pilas no recargables. NO cause cortocircuitos en las terminales de corriente.

DE Sicherheitsweise zu Batterien: Benötigt vier Mignonzellen AA (LR6) und drei 1,5 V-Alkali-Mikrozellen AAA (LR03) (nicht enthalten). Batterien sind kleine Gegenstände. Batterien müssen von Erwachsenen ausgewechselt werden. Das Polaritätsdiagramm (+/-) im Batteriefach beachten. Leere Batterien sofort aus dem Spielzeug entfernen. Verbrauchte Batterien ordnungsgemäß entsorgen. Bei längerfristiger Lagerung Batterien vorher entfernen. Nur dieselben oder gleichwertige Batterien wie empfohlen verwenden. Verbrauchte Batterien NICHT verbrennen. Batterien NICHT in Feuer entsorgen, da sie explodieren oder ausströmen könnten. Alte und neue Batterien oder verschiedene Batterietypen (z. B. Alkali/Standard) NICHT zusammen einlegen. KEINE aufladbaren Batterien verwenden. Nicht-aufladbare Batterien NICHT aufladen. Batteriepole NICHT kurzschließen.

NL Veiligheidsinformatie met betrekking tot de batterijen: Vereist 4 AA-alkalinebatterijen (LR6) en 3 AAA alkalinebatterijen (LR03) van 1,5 V (niet inbegrepen). Batterijen zijn kleine voorwerpen. Het vervangen van batterijen dient door volwassenen te worden gedaan. Houd je op het polariteitsdiagram (+/-) in het batterijvak. Verwijder lege batterijen onmiddellijk uit het speelgoed. Zorg voor een milieuvriendelijke afvalverwerking van de batterijen. Verwijder de batterijen als het speelgoed voor langere tijd wordt opgeborgen. Alleen batterijen van het aanbevolen type of een equivalent daarvan mogen worden gebruikt. Steek gebruikte batterijen NOOIT in brand. Gooi batterijen NOOIT in vuur. Hierdoor kunnen deze ontbranden of gaan lekken. Gebruik oude en nieuwe batterijen of verschillende typen batterijen (bijv. alkaline/standaard) NOOIT door elkaar. Gebruik GEEN oplaadbare batterijen. Laad niet-oplaadbare batterijen NOOIT op. Veroorzaak NOOIT kortsluiting tussen de contactpunten.

IT Informazioni di sicurezza per le pile: Richiede 4 pile alcaline AA/LR6 e 3 pile alcaline AAA/LR03 da 1,5 V (non incluse). Le pile sono oggetti di piccole dimensioni. Le pile devono essere sostituite da adulti. Seguire il diagramma della polarità (+/-) nello scomparto pile. Rimuovere rapidamente le pile scariche dal giocattolo. Smaltire correttamente le pile usate. Rimuovere le pile quando il prodotto non deve essere usato per periodi prolungati. Usare solo pile del tipo consigliato o di tipo equivalente. NON bruciare le pile usate. NON smaltire le pile usate nel fuoco: potrebbero esplodere o lasciar fuoriuscire il contenuto. NON mischiare pile vecchie e nuove o tipi di pile diverse (ad esempio alcaline e standard). NON usare pile ricaricabili. NON ricaricare pile non ricaricabili. NON cortocircuitare i terminali delle pile.

PT Informações de segurança sobre as pilhas: Requer 4 pilhas alcalinas tipo AA/LR6 e 3 pilhas alcalinas tipo AAA/LR03 de 1,5 V (não incluídas). As pilhas são objetos pequenos. A substituição das pilhas deverá ser feita por um adulto. Deverá seguir-se a indicação da polaridade (+/-) no compartimento das pilhas. As pilhas gastas deverão ser imediatamente retiradas do brinquedo. As pilhas usadas deverão ser corretamente descartadas. Remover as pilhas durante períodos prolongados de armazenamento. Deverão utilizar-se apenas pilhas do mesmo tipo (ou de um tipo equivalente) do recomendado. NÃO incinerar pilhas usadas. NÃO eliminar pilhas em fogo, pois podem explodir ou vazar. NÃO combinar pilhas usadas e novas ou tipos de pilhas (p. ex.: alcalinas/padrão). NÃO usar pilhas recarregáveis. NÃO recarregar pilhas não recarregáveis. NÃO permitir que ocorra curto-circuito nos terminais do produto.

RU Информация по безопасному обращению с элементами питания: требуются 4 элемента питания типа AA/LR6 и 3 щелочные элемента питания типа AAA/LR03 с напряжением 1,5 В (не входят в комплект). Элементы питания представляют собой миниатюрные предметы. Замену элементов питания должны выполнять взрослые. Соблюдайте полярность (+/-), указанную в отсеке элементов питания. Не оставляйте разрядившиеся элементы питания в игрушке. Утилизируйте элементы питания надлежащим образом. Извлекайте элементы питания, если игрушка не используется долгое время. Рекомендуется использовать элементы питания одного или эквивалентного типа. Не сжигайте использованные элементы питания. Не бросайте элементы питания в огонь. Это может привести к их утечке или взрыву. Не используйте новые элементы питания в сочетании с использованными или элементами питания разного типа (т.е. щелочные/обычные). Не используйте новые перезаряжаемые элементы питания. ЗАПРЕЩАЕТСЯ заряжать перезаряжаемые элементы питания. ИЗБЕГАЙТЕ короткого замыкания источников питания.

EN. Remove all packaging before use. Retain this information, addresses and phone numbers for future reference. Content may vary from pictures. Meccano reserves the right to discontinue the website www.meccano.com at any time. An adult should periodically check this toy to ensure no damage or hazards exist, if so, remove from use. Children should be supervised during play.

FR. Retirer tout l'emballage avant utilisation. Conserver les informations, adresses et numéros de téléphone pour consultation ultérieure. Le contenu peut différer des images. Meccano se réserve le droit de supprimer le site Internet www.meccano.com à tout moment. Un adulte doit régulièrement examiner ce jouet afin de s'assurer qu'il ne présente pas de dommage ni de risque. En cas de problème, ne plus l'utiliser. Les enfants doivent être surveillés lorsqu'ils jouent.

ES. Retire todo el embalaje antes de utilizar el producto. Conserve toda la información, las direcciones y los números de teléfono para futuras referencias. El contenido del paquete puede no corresponder con las imágenes. Meccano se reserva el derecho a suspender el sitio web www.meccano.com en cualquier momento. Un adulto debe revisar de forma periódica el juguete para asegurarse de que no supone un riesgo o peligro para el niño; si así fuera el caso, interrumpa su uso. Supervise a los niños mientras juegan con el producto.

DE. Entfernen Sie vor der Benutzung sämtliche Verpackungsmaterialien. Alle Informationen, Adressen und Telefonnummern bitte für mögliche Rückfragen aufbewahren. Der Packungsinhalt kann von den Bildern abweichen. Meccano behält sich das Recht vor, den Betrieb der Website www.meccano.com jederzeit einzustellen. Ein Erwachsener sollte regelmäßig sicherstellen, dass das Spielzeug keine Gefahr darstellt, und es gegebenenfalls entfernen. Kinder sollten beim Spielen beaufsichtigt werden.

NL. Verwijder de verpakking voor gebruik. Bewaar deze informatie, adressen en telefoonnummers voor toekomstig gebruik. Inhoud kan afwijken van illustraties. Meccano behoudt zich het recht voor de website www.meccano.com wanneer gewenst buiten gebruik te stellen. Een volwassene dient dit speelgoed regelmatig te controleren. In geval van schade of gevaar het speelgoed niet meer gebruiken. Houd toezicht als kinderen spelen.

IT. Rimuovere l'imballo prima dell'uso. Conservare informazioni, indirizzi e numeri di telefono per riferimento futuro. Il prodotto potrebbe essere differente dalle immagini. Meccano si riserva il diritto di rimuovere il sito www.meccano.com in qualsiasi momento. Il giocattolo deve essere periodicamente controllato da un adulto per prevenire eventuali danni o rischi; in caso di danno, sospendere l'uso. I bambini devono essere sorvegliati durante il gioco.

PT. Remova totalmente a embalagem antes de utilizar. Guarde todos os endereços, números de telefone e demais informações para consulta e referência. O conteúdo poderá ser diferente das ilustrações. A Meccano reserva-se o direito de descontinuar o site www.meccano.com a qualquer altura. Um adulto deve verificar o brinquedo periodicamente para garantir que não há danos ou riscos. Se houver, é necessário que o brinquedo seja retirado de uso. Crianças devem ser supervisionadas enquanto brincam.

RU. Снимите все упаковочные материалы перед использованием. Запишите указанные на упаковке адреса и номера телефонов, чтобы у вас была возможность связаться с нами. Содержимое упаковки может отличаться от иллюстрации. Компания Meccano оставляет за собой право прекратить использование сайта www.meccano.com в любое время. Взрослым следует время от времени проверять игру и следить за тем, чтобы она не была сломана и не представляла опасности для ребенка. В противном случае ее не следует использовать. Во время игры дети должны находиться под присмотром взрослых.

- ⚠ Warning: CHOKING HAZARD – Small parts.
- ⚠ Attention ! RISQUE D'ETOUFFEMENT – Contient de petits éléments.
- ⚠ Advertencia: PELIGRO DE ASFIXIA – Contiene piezas pequeñas. No conveniente para niños menores de 3 años.
- ⚠ Achtung: ERSTICKUNGSGEFAHR – Kleinteile.
- ⚠ Waarschuwing: VERSTIKKINGSGEVAAR – Kleine onderdelen.
- ⚠ Attenzione: RISCHIO DI SOFFOCAMENTO – Pezzi piccoli.
- ⚠ Aviso: PERIGO DE ASFIXIA – Peças pequenas.
- ⚠ Осторожно! ОПАСНОСТЬ УДУШЬЯ – Мелкие детали.



- ⚠ CAUTION! Hair Entanglement. Tie back and cover hair and secure loose clothing prior to play.
- ⚠ MISE EN GARDE! Les cheveux peuvent se coincer. Attacher les cheveux et les couvrir, et maintenir les vêtements amples à l'écart du jouet.
- ⚠ ¡PRECAUCIÓN! Enredo de pelo. Asegúrese de llevar el pelo recogido y cubierto; revise si lleva puesto algo que se pueda enredar.
- ⚠ ACHTUNG! Haare könnten sich verfangen. Vor dem Spielen Haare zusammenbinden und bedecken, weite Kleidung sichern.
- ⚠ VOORZICHTIG! Haar kan verstrikt raken. Bind het haar naar achteren en bedek het. Maak loshangende kleding vast voor gebruik.
- ⚠ ATTENZIONE! Intrappolamento dei capelli. Legare e coprire i capelli prima di giocare e tenere gli abiti lontano dal prodotto.
- ⚠ CUIDADO! Há possibilidade de prender o cabelo. Prenda e cubra o cabelo, assegure-se de prender qualquer peça de roupa solta antes de utilizar o produto.
- ⚠ ОСТОРОЖНО! Игрушка может запутать волосы. Перед игрой следует подвязать волосы и прикрыть голову, а также проследить за тем, чтобы игрушка находилась на безопасном расстоянии от неприлегающих элементов одежды.

NORTH AMERICA / AMÉRIQUE DU NORD
1-800-622-8339, customercare@spinmaster.com
UK – 0800 206 1191, serviceuk@spinmaster.com
IRELAND – 1800 992 249
FRANCE – 0800 909 150, servicefr@spinmaster.com
DEUTSCHLAND – 0800 0101 0222, Kundenservice@spinmaster.com
SCHWEIZ – 0800 561 350 • ÖSTERREICH – 0800 297 267
NEDERLAND – 0800 022 3683, klantenservice@spinmaster.com
BELGIË/BELGIQUE – 0800 77 688 • LUXEMBOURG – 800 2 8044
ITALIA – 800 788 532, servizio@spinmaster.com
MEXICO – 55 4160 7947, servicio@spinmaster.com



WWW.SPINMASTER.COM

SPIN MASTER LTD., 450 FRONT STREET WEST, TORONTO, ON M5V 1B6 CANADA.
IMPORTED INTO EU BY SPIN MASTER INTERNATIONAL, S.A.R.L.,
16 AVENUE PASTEUR, L-2310, Luxembourg. www.spinmaster.com
Made in China / Fabriqué en Chine / Hecho en China



TM & © 2016 MECCANO for packaging, instructions and models built with this set. / TM & © 2016 MECCANO pour l'emballage, les notices et modèles de ce coffret. / MECCANO® is an exclusive trademark of MECCANO. Spin Master logo is a trademark of Spin Master Ltd. / MECCANO® est une marque de commerce exclusive de MECCANO. The logo of Spin Master est une marque de commerce de Spin Master Ltd. / All rights reserved. / Tous droits réservés.

T91826_0001_20074016/0003_GML_IB_R1_MEC_LIC LambghiniHuracan RC_CN_F16