

MECCANOTM
M A K E R S Y S T E M

MONSTER 1200 STM 

16305



 **10+**

Instructions
Notice de montage
Instrucciones de construcción
Bauanleitung

Bouwinstructie
Istruzioni
Instruções
Инструкции



- Ⓒ Please print at scale 1 without the printer margins.
- Ⓕ Merci d'imprimer à l'échelle 1 sans les marges de l'imprimante.
- Ⓖ Imprimir a escala 1 sin márgenes de impresión.
- Ⓓ Maßstab 1 bitte randlos drucken.
- Ⓜ Print op schaal 1 zonder de printermarges.
- Ⓛ Stampare in scala 1 senza i margini della stampante.
- Ⓟ Imprima em escala 1 sem as margens da impressora.
- Ⓡ Распечатать в масштабе 1:1 без полей.





CONSTRUCTION TIPS / ASTUCES DE CONSTRUCTION
TIPS DE CONSTRUCCIÓN / TIPPS ZUM BAUEN
MONTAGETIPS / SUGGERIMENTI PER COSTRUIRE
DICAS DE MONTAGEM / РЕКОМЕНДАЦИИ ПО СБОРКЕ

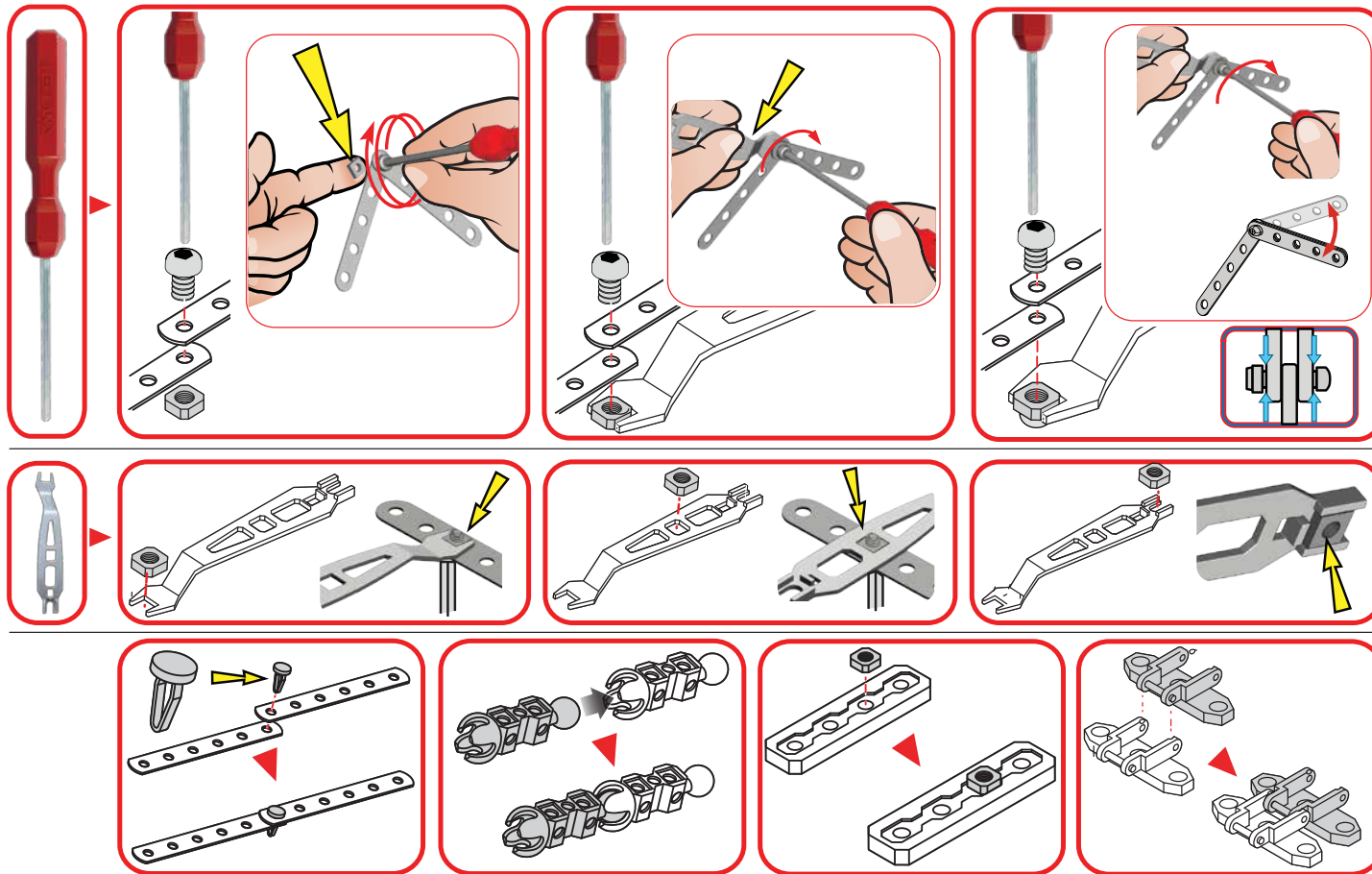
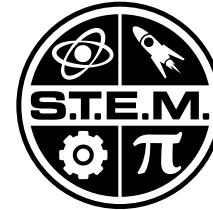

TABLE OF CONTENTS/SOMMAIRE

ÍNDICE / INHALTSVERZEICHNIS / INHOUD / INDICE / ÍNDICE / СОДЕРЖАНИЕ



4



GB. Content : 292 parts, 2 real tools, 1 sticker sheet, 1 instruction sheet for 1 model.
F. Contenu : 292 pièces, 2 vrais outils, 1 feuillet d'autocollants, 1 notice de montage pour 1 modèle.
E. Contenido : 292 piezas, 2 herramientas reales, 1 hoja de calcomanías, 1 guía de instrucciones para 1 modelo.
D. Inhalt: 292 Teile, 2 echte Werkzeuge, 1 Bogen mit Aufklebern, 1 Bauanleitung für 1 Modell.
NL. Inhoud : 292 onderdelen, 2 stuks gereedschap, 1 stickervel, 1 bouw instructie voor 1 model.
I. Contenuto : 292 pezzi, 2 attrezzi, 1 foglio di adesivi, 1 guida per l'uso per 1 modello.
P. Conteúdo: 292 peças, 2 ferramentas reais, 1 cartela de adesivos, 1 folha de instruções para 1 modelo.
R. В коробке: 292 детали, 2 настоящих инструмента, 1 лист с наклейками, 1 инструкция по сборке 1 модели.

GB. For information on how this product supports today's STEM curriculum, visit www.meccano.com.

F. Pour découvrir l'intérêt pédagogique de ce produit dans le cadre des matières STEM, rendez-vous sur www.meccano.com.

E. Para mayor información sobre cómo este producto respalda las materias STEM visita: www.meccano.com.

D. Für Informationen wie dieses Produkt den technisch-mathematischen Lehrplan (STEM) unterstützt, besuchen Sie bitte www.meccano.com.

NL. Ga naar www.meccano.com voor meer informatie over hoe dit product het huidige STEM-curriculum ondersteunt.





I. Per informazioni su come questo prodotto contribuisce ad aiutare i ragazzi nelle materie STEM "scientifiche e tecniche", visitare il sito www.meccano.com.

P. Para informações sobre a compatibilidade deste produto com os programas atuais STEM, acesse www.meccano.com.

R. Информация о том, как с помощью этого продукта можно повысить эффективность процесса изучения дисциплин STEM, представлена на сайте www.meccano.com.



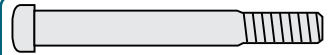
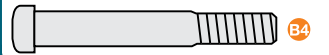

1

| | | | |
|---|-----------|---|---|
|  | x1 |  | B5 38.1 mm x1 1 1/2" |
|  | x1 |  | B4 32 mm x1 1 1/4" |
| | |  | x1 |

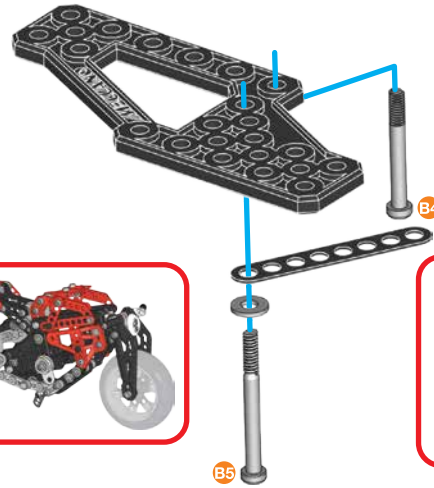
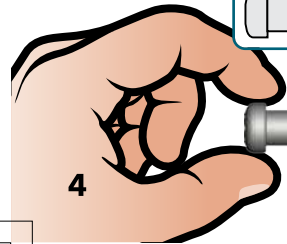
| | | |
|--|-----------|------------|
|  | B5 | 1:1 |
|  | B4 | |



2

| | |
|---|-----------|
|  | x1 |
|  | x1 |

| | | |
|---|-----------|------------|
|  | B3 | 1:1 |
|---|-----------|------------|

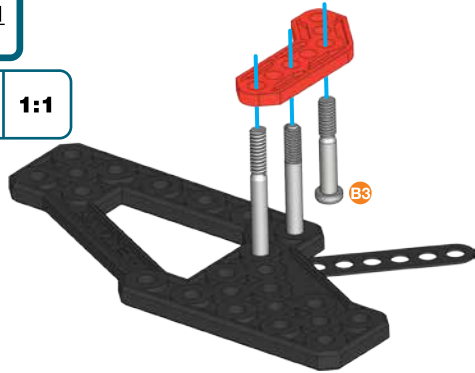

3

| | |
|--|-----------|
|  | x1 |
|--|-----------|

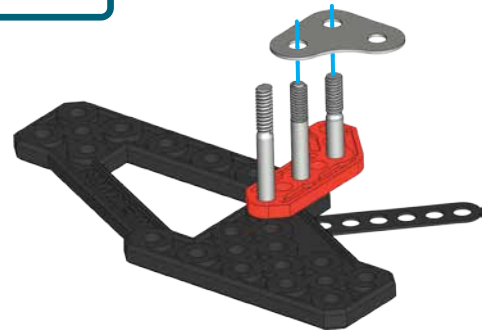

4

| | |
|---|-----------|
|  | x4 |
|---|-----------|

| | | | |
|---|---|-------------|------------|
|  |  | A338 | 1:1 |
|---|---|-------------|------------|

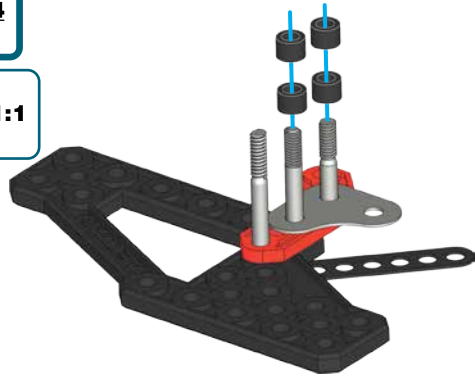

5

| | |
|---|-----------|
|  | x1 |
|  | x1 |
|  | x1 |

| | | | |
|--|---|-------------|------------|
|  |  | A238 | 1:1 |
|  |  | A338 | |

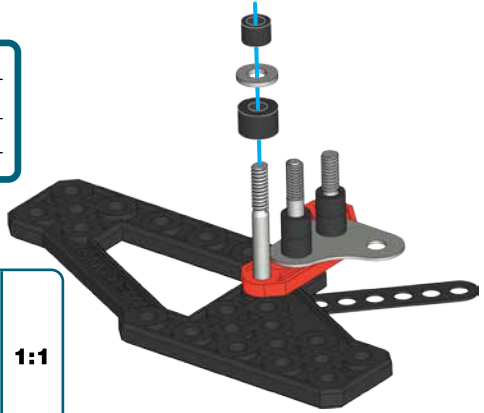

6

x1

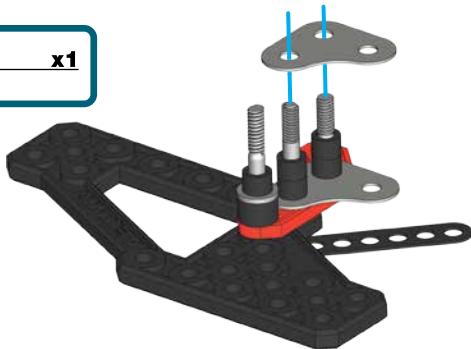

7

x1

x1

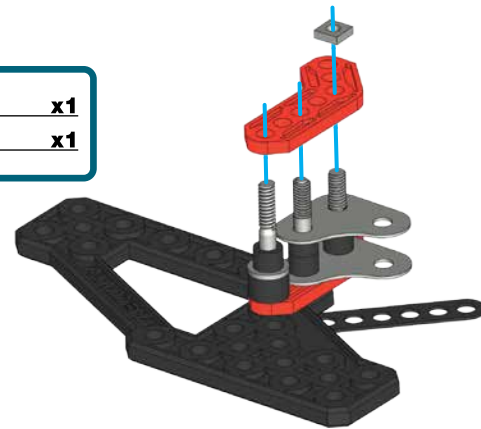

8

x1

x1

x2

x1

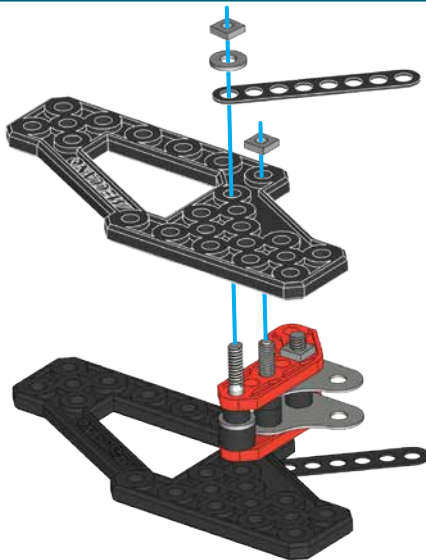

9

x1

x1

19 mm
3/4"

x1



x2

x1

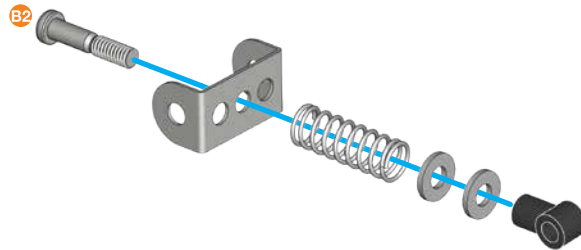
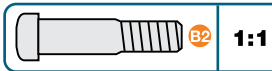
1:1





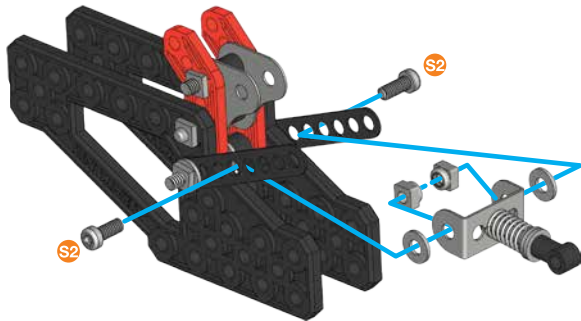
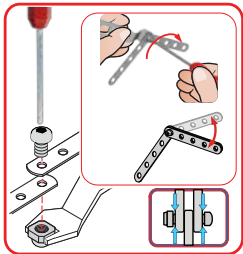

10**(8) + (9) +**

| | | |
|---|----------------|-----------|
|  | 9,5 mm 3/8" | x2 |
|  | | x2 |
|  | | x2 |





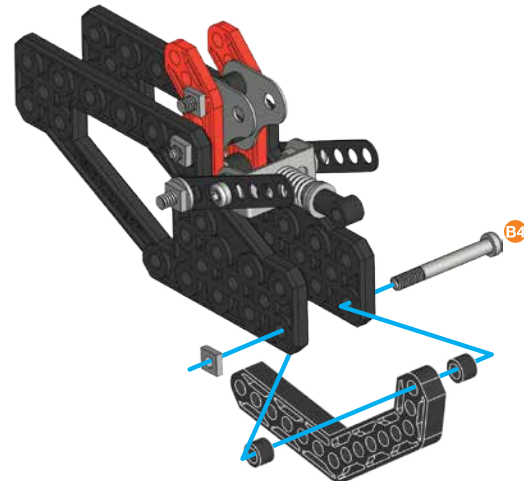

| | | |
|---|-----------|------------|
|  | S2 | 1:1 |
|---|-----------|------------|

**12**

| | | |
|---|-----------------|-----------|
|  | | x1 |
|  | | x2 |
|  | 32 mm 1 1/4" | x1 |
|  | | x1 |

| | | | |
|---|---|-------------|------------|
|  |  | A338 | 1:1 |
|  | | B4 | |



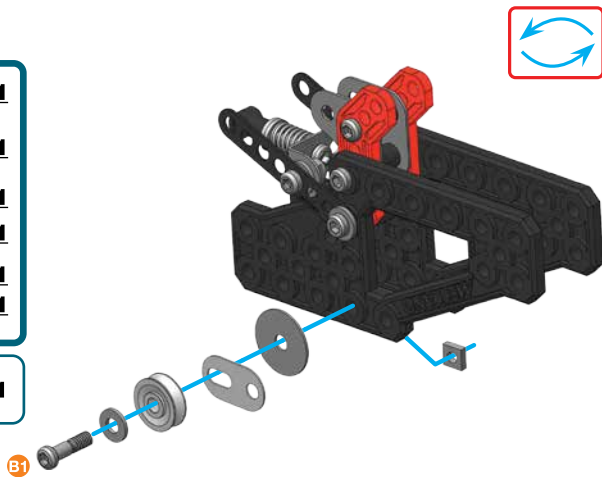

**11**

| | | |
|---|-------------------|-----------|
|  | | x1 |
|  | | x1 |
|  | | x1 |
|  | | x1 |
|  | 14,7 mm 37/64" | x1 |
|  | | x1 |

| | | |
|---|-----------|------------|
|  | B1 | 1:1 |
|---|-----------|------------|



13



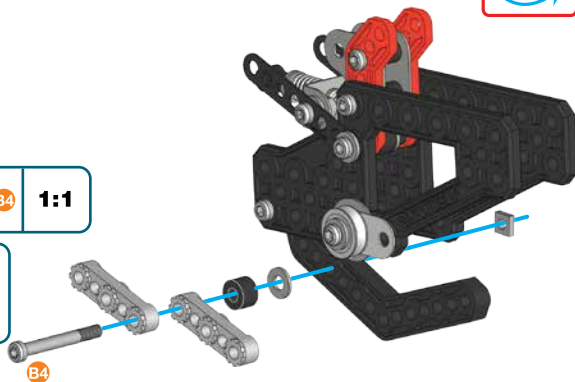

-  **x2**
-  **x1**
-  **x1**
-  **x1** B4 32 mm
1 1/4"
-  **x1**

-  **B4 1:1**

-   **A238 1:1**





14

-  **x2**
-  **x2**
-  **x2**
-  **x1** B5 38,1 mm
1 1/2"
-  **x1**

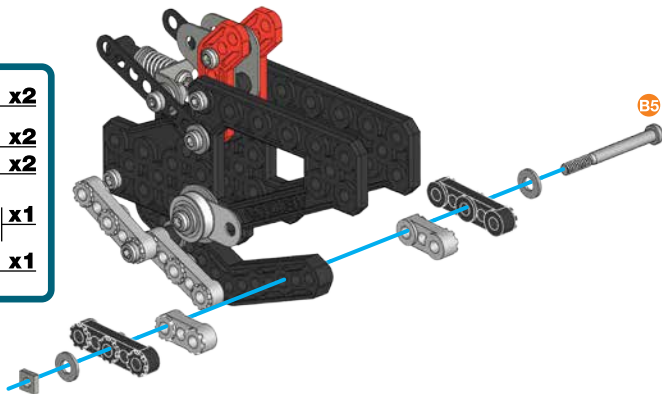
-  **B5 1:1**



15

-  **x1**
-  **x2** B1 14,7 mm
37/64"
-  **x2**

-  **B1 1:1**

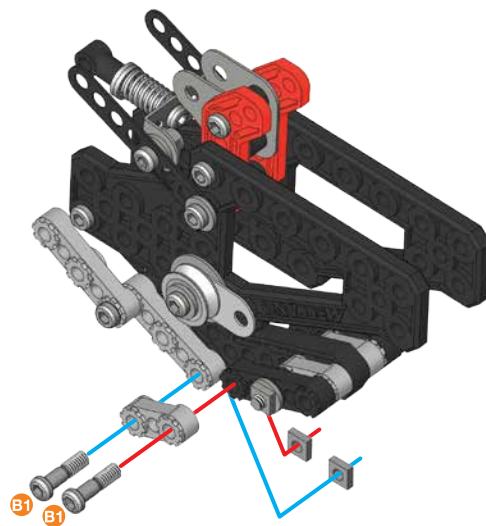







16

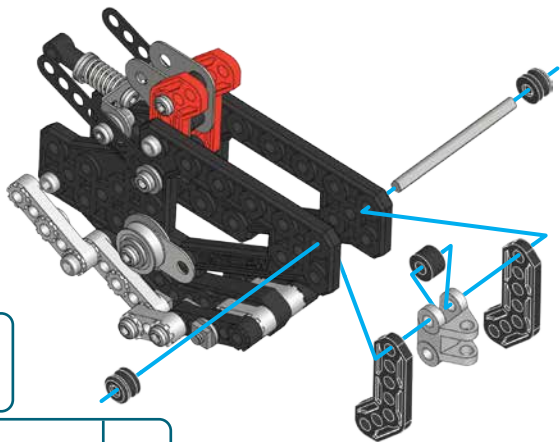

| | | |
|---|-------------------|-----------|
|  | 50 mm 1 15/16" | x1 |
|  | | x2 |
|  | | x1 |
|  | | x2 |
|  | | x1 |

| | | | |
|---|---|-------------|------------|
|  |  | A238 | 1:1 |
|---|---|-------------|------------|



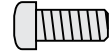

| | |
|---|------------|
|  | 1:1 |
|---|------------|

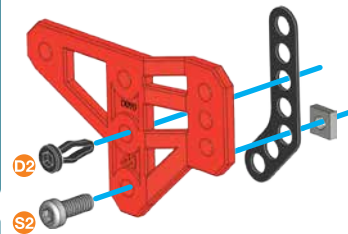

**17**

| | | |
|---|-----------------------|-----------|
|  | | x1 |
|  | | x1 |
|  | D2 13,05 mm 17/32" | x1 |
|  | S2 9,5 mm 3/8" | x1 |
|  | | x1 |

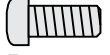

| | | |
|---|----|------------|
|  | S2 | 1:1 |
|  | D2 | |

**18**

| | | |
|--|-----------------------|-----------|
|  | | x1 |
|  | | x1 |
|  | D2 13,05 mm 17/32" | x1 |
|  | S2 9,5 mm 3/8" | x1 |
|  | | x1 |

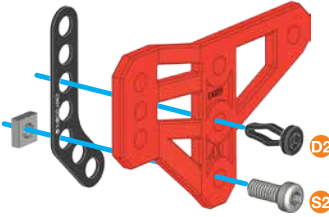
| | | |
|---|----|------------|
|  | S2 | 1:1 |
|  | D2 | |

**19**

| | | |
|---|----------------------|-----------|
| 16 + 17 + 18 + | | |
|  | B5 38,1 mm 1 1/2" | x1 |
|  | | x1 |

| | | |
|--|----|------------|
|  | B5 | 1:1 |
|--|----|------------|

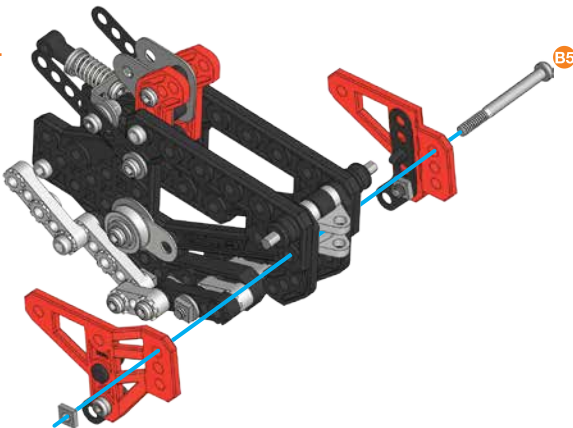

20

- x2
- 14,7 mm | x2
- 37/64" | x2

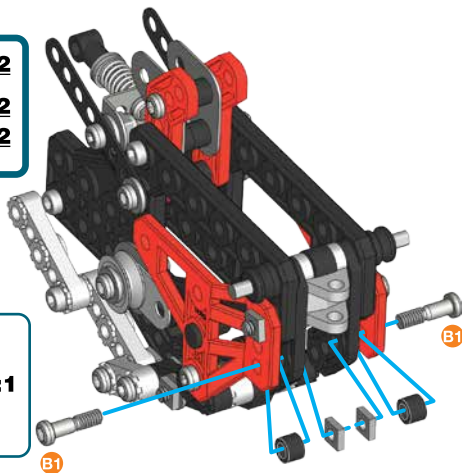

- A338
- B1
- 1:1

21

- 38,1 mm | x1
- 1 1/2" | x1
- x1
- x2

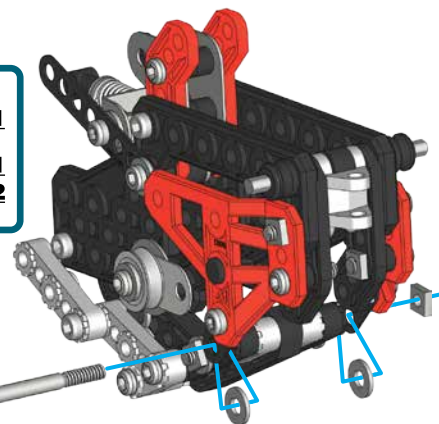

- 38,1 mm | x1
- 1 1/2" | x1
- x1
- x2

22

- x1
- x1
- 11,25 mm | x1
- 7/16" | x1

- D1
- 1:1

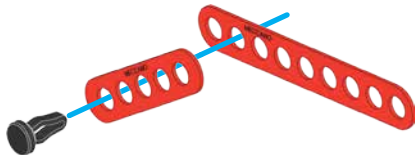



23

- x1
- x1
- x1
- x1
- 12 mm | x1
- 1/2" | x1

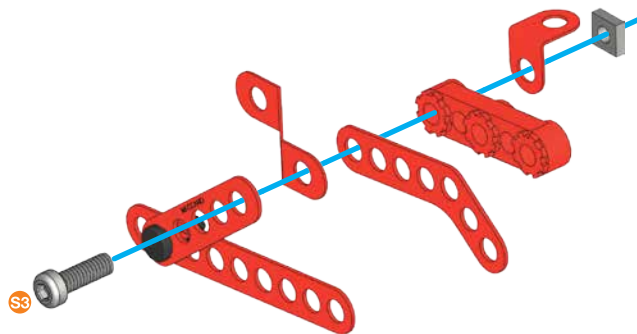
- S3
- 1:1





24

| | |
|---|-----------|
|  | x1 |
|  5,8 mm 15/64" | x1 |
|  | x1 |

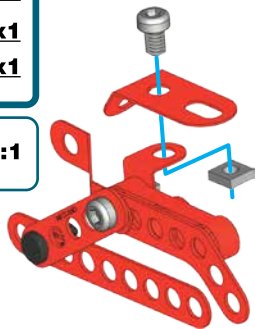

| | | |
|---|-----------|------------|
|  | S1 | 1:1 |
|---|-----------|------------|

**25****(21)+(24)+**

| | |
|---|-----------|
|  | x1 |
|  5,8 mm 15/64" | x1 |
|  | x1 |

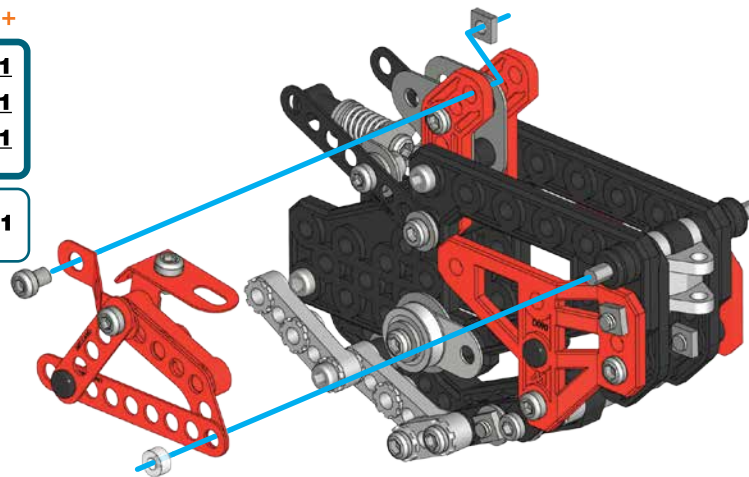



| | | |
|---|-----------|------------|
|  | S1 | 1:1 |
|---|-----------|------------|

**26**

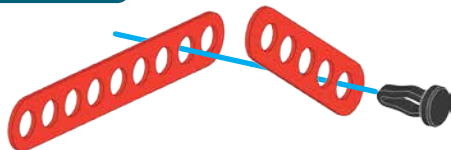
| | |
|--|-----------|
|  | x1 |
|  | x1 |
|  11,25 mm 7/16" | x1 |

| | | |
|---|-----------|------------|
|  | D1 | 1:1 |
|---|-----------|------------|

**27**

| | |
|--|-----------|
|  | x1 |
|  | x1 |
|  | x1 |
|  12 mm 1/2" | x1 |
|  | x1 |

| | | |
|---|-----------|------------|
|  | S3 | 1:1 |
|---|-----------|------------|

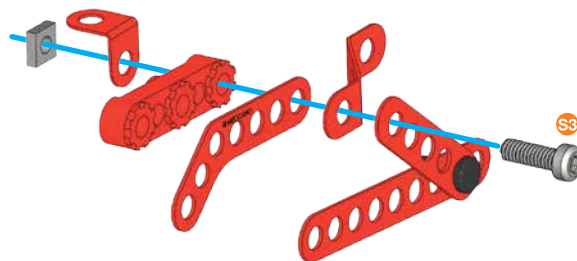

28

| | |
|--|-----------|
| | x1 |
| | x1 |
| | x1 |

| | | |
|--|-----------|------------|
| | S1 | 1:1 |
|--|-----------|------------|

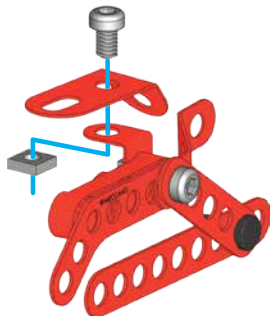
**29****25 + 28 +**

| | |
|--|-----------|
| | x1 |
| | x1 |
| | x1 |

| | | |
|--|-----------|------------|
| | S1 | 1:1 |
|--|-----------|------------|

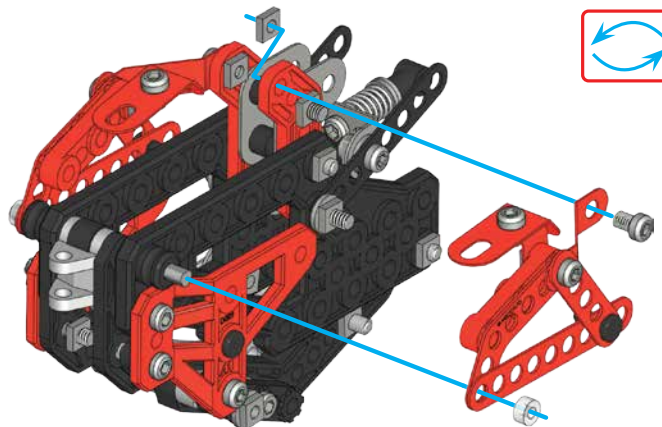
**30**

| | |
|--|-----------|
| | x1 |
| | x1 |
| | x1 |
| | x1 |
| | x1 |

| | | |
|--|-----------|------------|
| | S2 | 1:1 |
|--|-----------|------------|

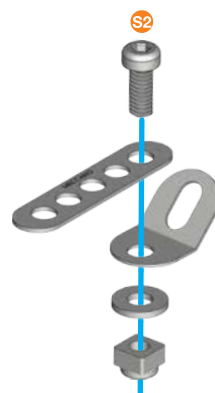
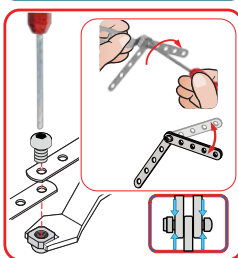



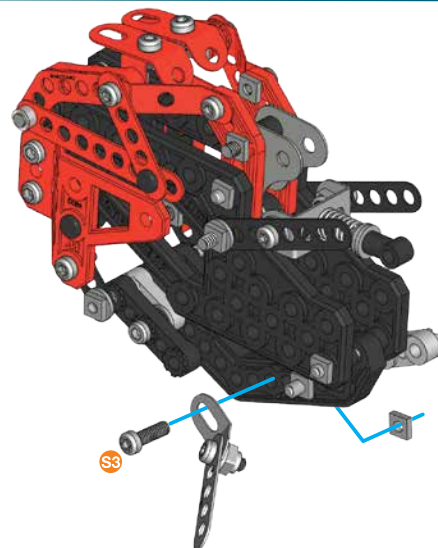

**31****29 + 30 +**

| | |
|--|-----------|
| | x1 |
| | x1 |



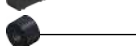

| | | |
|--|-----------|------------|
| | S3 | 1:1 |
|--|-----------|------------|

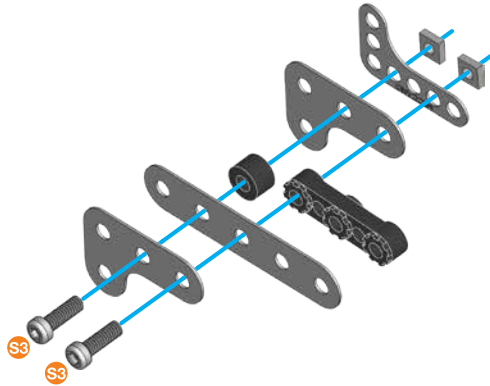

32





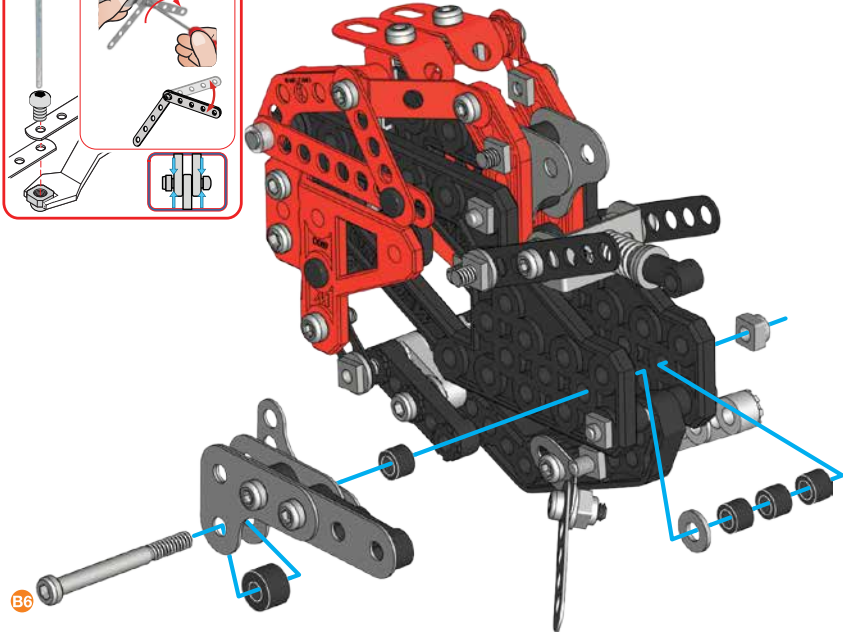
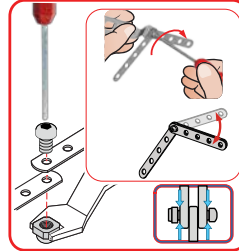

-  **x1**
-  **x2**
-  **x1**
-  **x1**
-  **x1**
-  **x2** | 12 mm | 1/2"
-  **x2**

**33****(31) + (32) +**







-  **x1**
-  **x4**
-  **x1**
-  **x1** | 44,5 mm | 1 3/4"
-  **x1**

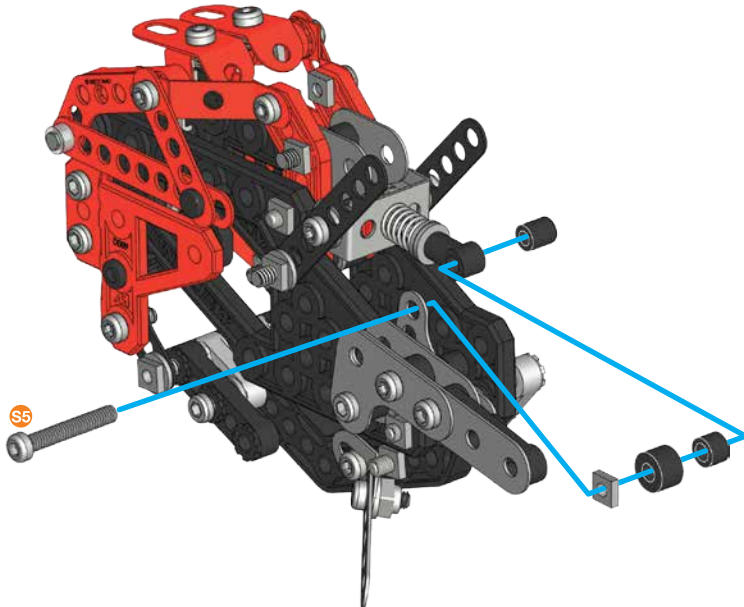
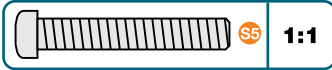





34

-  **x1**
-  **x1**
-  **x1**
-  **x1**
-  | 25,4 mm | **x1**
-  | 1" | **x1**

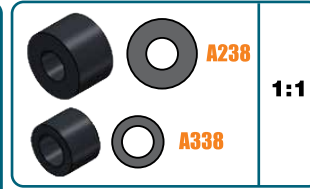
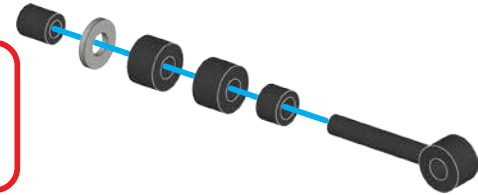
**1:1****35**



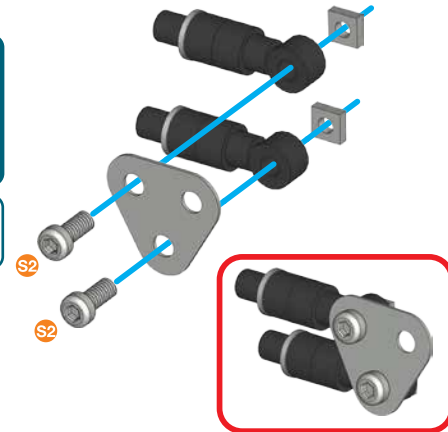

-  **x2**
-  **x4**
-  **x2**
-  **x2**
-  **x2**
-  **x2**

**1:1****x2****36**

-  **x1**
-  | 9,5 mm | **x2**
-  | 3/8" | **x2**
-  **x2**





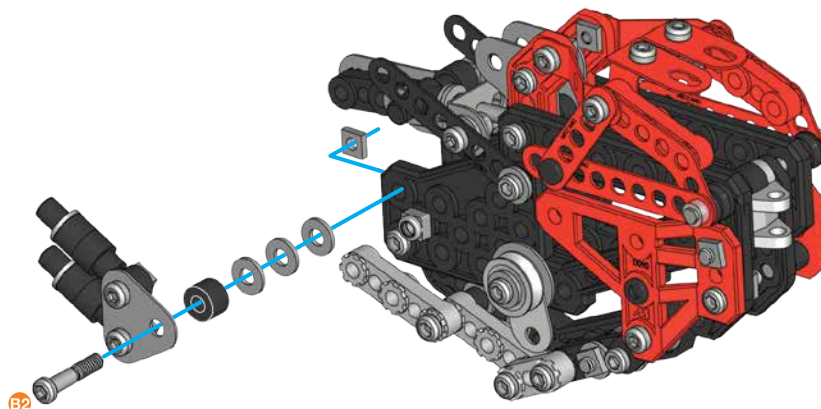

37**34 + 36 +**

-  **x1**
-  | 19 mm | **x1**
3/4"
-  **x1**
-  **x3**

-  **A238**
-  **1:1**
-  **S2**

**38**

-  **x1**
-  **x1**
-  **x1**
-  | 9,5 mm | **x1**
3/8"
-  **x1**

-  **S2** **1:1**

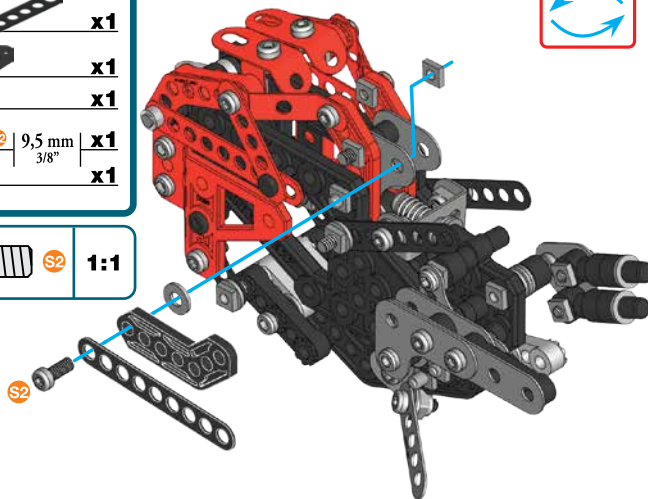

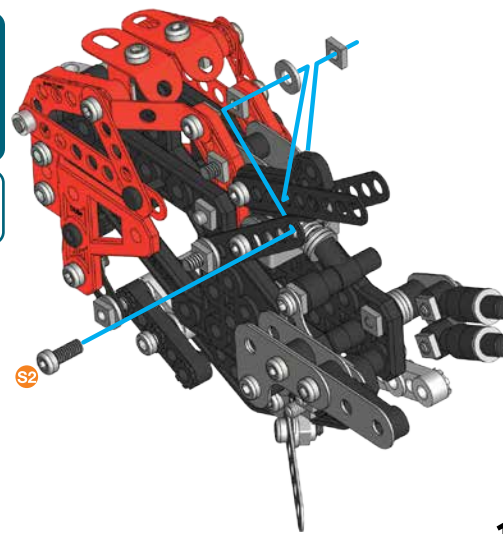

**39**

-  **x1**
-  | 9,5 mm | **x1**
3/8"
-  **x1**

-  **S2** **1:1**



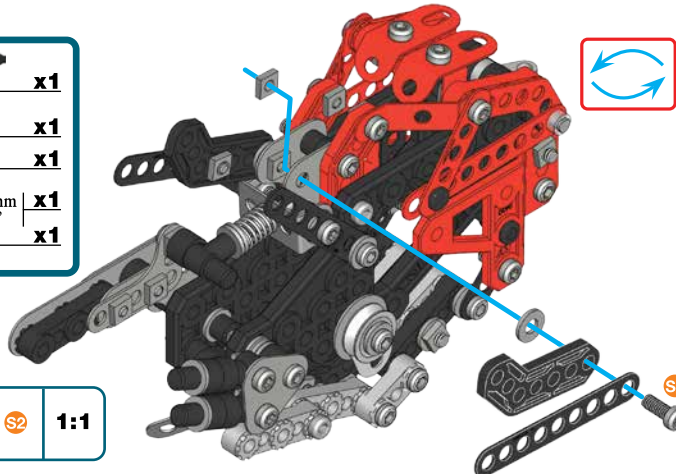

40

-  x1
-  x1
-  x1
-  | 9,5 mm | x1
3/8"
-  x1



-  | 1:1





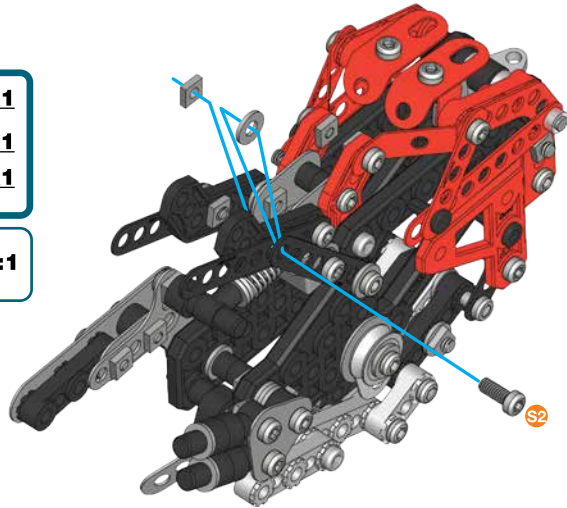

41



-  x1
-  | 9,5 mm | x1
3/8"
-  x1



-  | 1:1

42

-  x1
-  x1
-  x1
-  x1
-  | 14,7 mm | x1
37/64"
-  x1

-   A338
-  B1
- 1:1

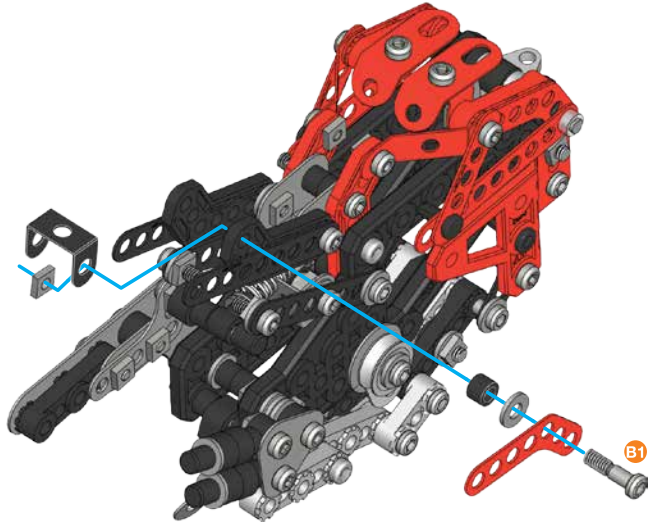

43

- x1**
- x1**
- x1**
- x1**
- x1**

- x1**
 - x1**
 - A338**
 - B1**
- 1:1**

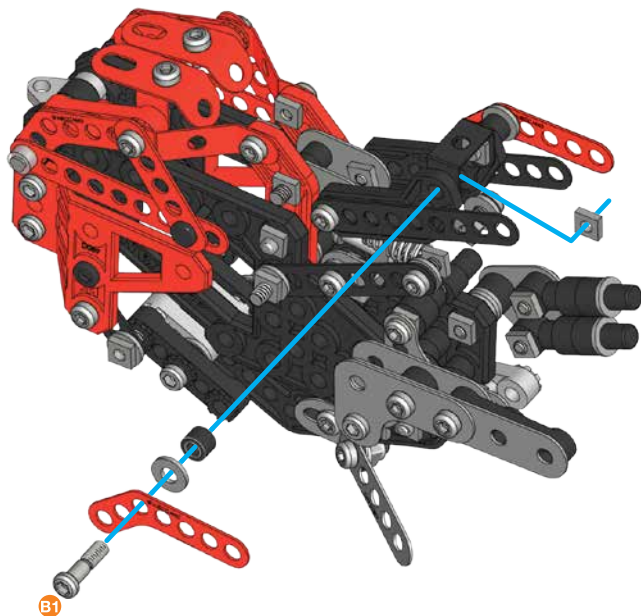

44

- x1**
- x1**
- x1**
- x1**

- S2**
- 1:1**





45

- x1**
- x1**
- x1**
- x1**

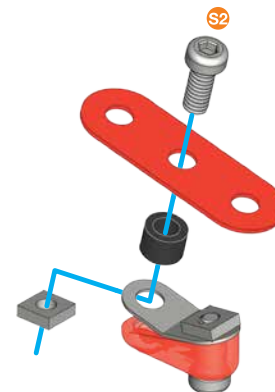
- x1**
 - A338**
 - S2**
- 1:1**





46**43+45+**

| | | |
|---|-----------------------|-----------|
|  | S1 5,8 mm 15/64" | x1 |
|  | | x1 |

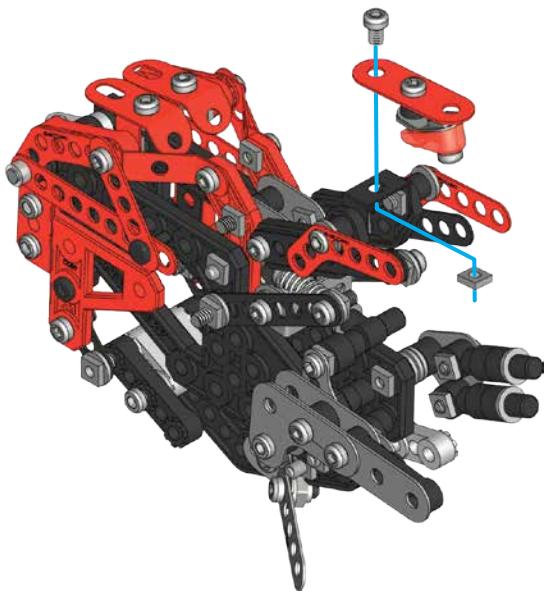

| | | |
|---|----|------------|
|  | S1 | 1:1 |
|---|----|------------|

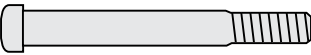

**47**

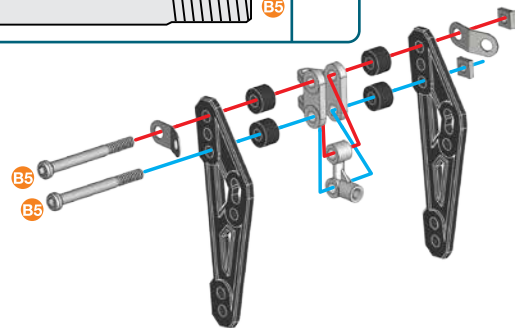
| | | |
|---|------------------------|-----------|
|  | x2 | |
|  | x1 | |
|  | x1 | |
|  | x2 | |
|  | x4 | |
|  | B5 38,1 mm 1 1/2" | x2 |
|  | x2 | |

| | | | |
|---|---|-------------|------------|
|  |  | A238 | 1:1 |
|  | B5 | | |



**48**

| | | |
|---|----------------------|-----------|
|  | x8 | |
|  | B3 23 mm 15/16" | x2 |
|  | x2 | |

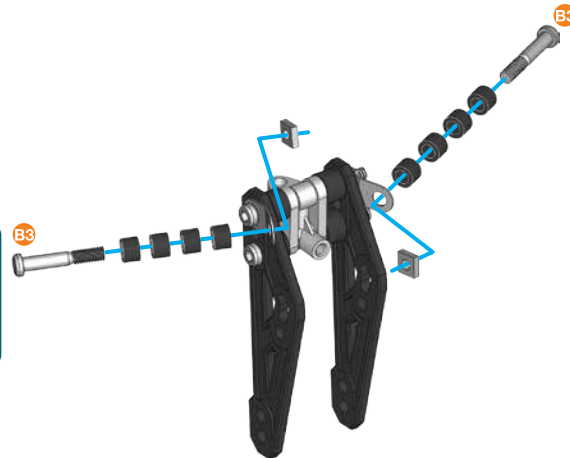
| | | | |
|--|---|-------------|------------|
|  |  | A338 | 1:1 |
|  | B3 | | |



49

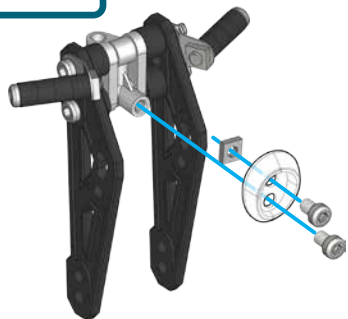

-  **x1**
-  | 5,8 mm | **x2**
15/64"
-  **x2**

-  **S1** **1:1**



50

46 + 49 +



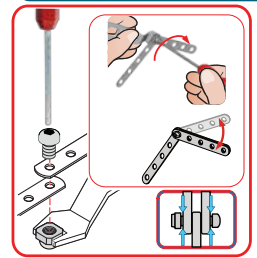

-  | 23 mm | **x1**
1 5/16"
-  **x1**

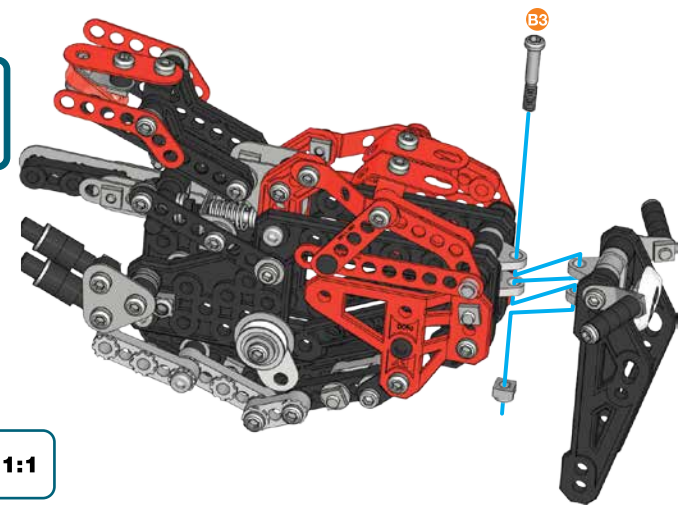

-  **B3** **1:1**



51

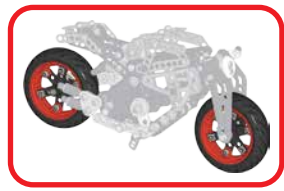

-  **x1**
-  **x1**
-  | 9,5 mm | **x3**
3/8"
-  **x3**

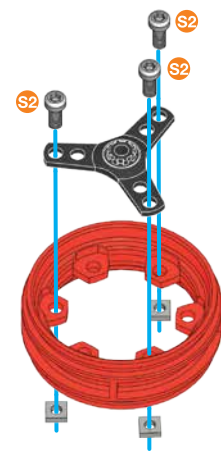

-  **S2** **1:1**



52

-  **x1**
-  | 9,5 mm | **x3**
3/8"
-  **x3**

-  **S2** **1:1**

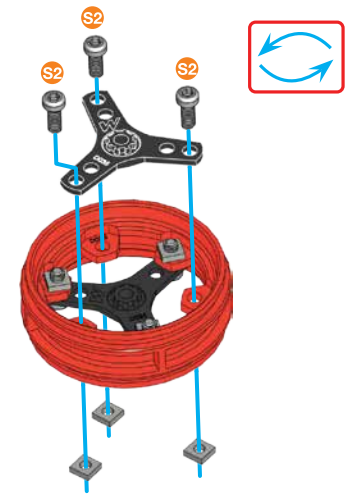

53



x1

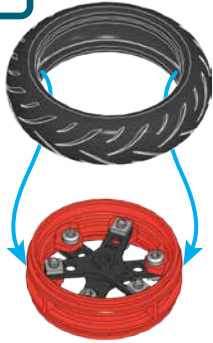

54

51~53



55

50+54+



40 mm
1 9/16" x1



x2



x2

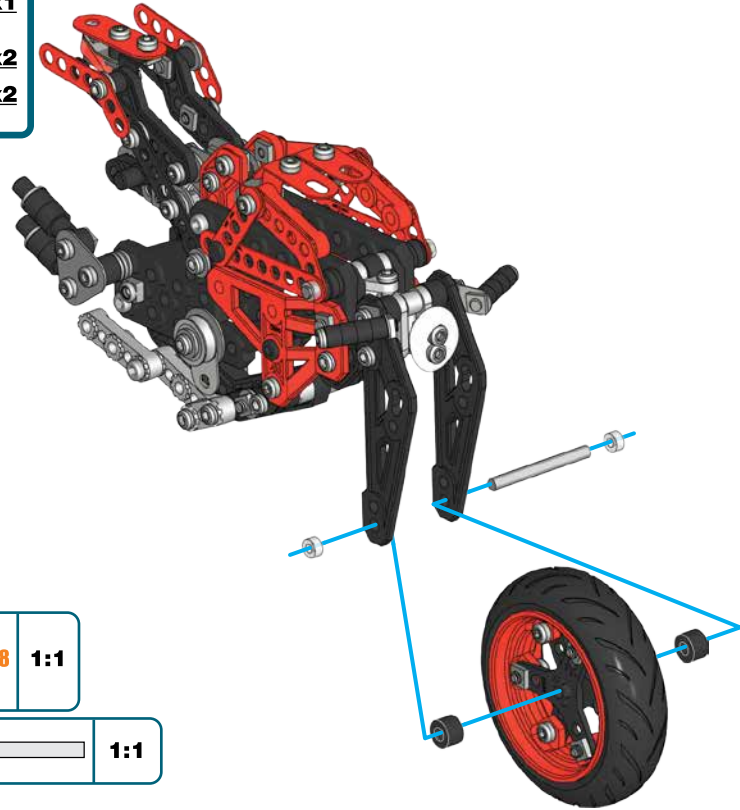



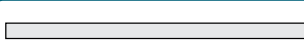

A238 1:1



1:1

56**54+**

| | |
|---|-----------|
|  | x1 |
|  | x1 |
|  | x2 |
|  | x1 |
|  | x1 |

B6

44,5 mm

x1

1 3/4"

x1

| | | | |
|---|---|-------------|------------|
|  |  | A238 | 1:1 |
|---|---|-------------|------------|

| | | |
|---|-----------|------------|
|  | B6 | 1:1 |
|---|-----------|------------|

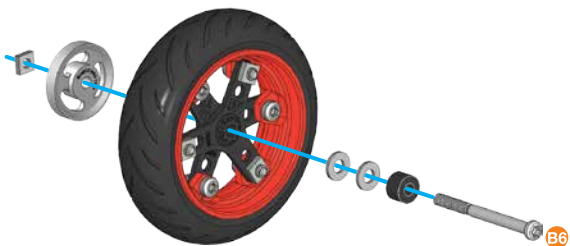
**57****55+56+**

| | |
|---|-----------|
|  | x1 |
|  | x1 |



| | | | |
|---|---|-------------|------------|
|  |  | A338 | 1:1 |
|---|---|-------------|------------|

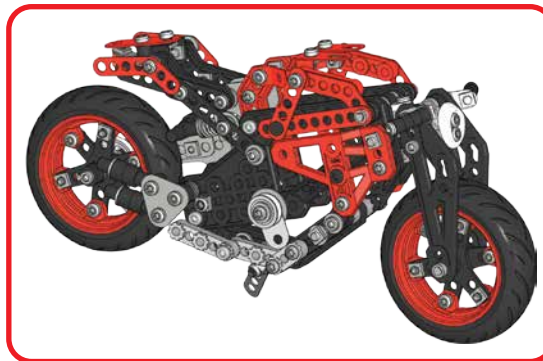
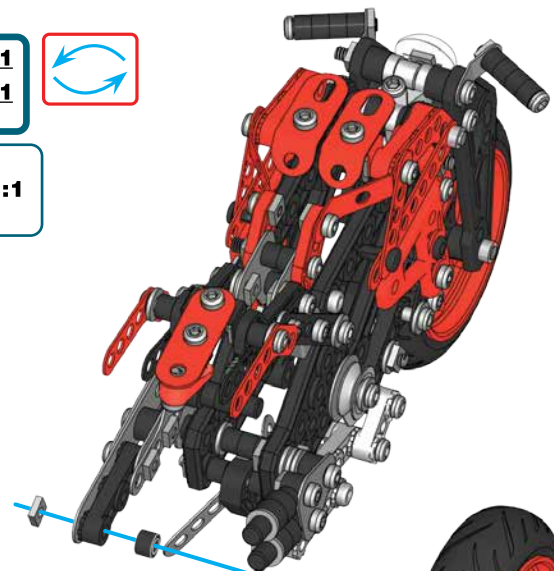

58



- ⚠ CAUTION: Stickers not intended to be placed on skin.
- ⚠ MISE EN GARDE: Les autocollants ne sont pas destinés à être placés sur la peau.
- ⚠ PRECAUCION: Las calcomanías no deben colocarse sobre la piel.

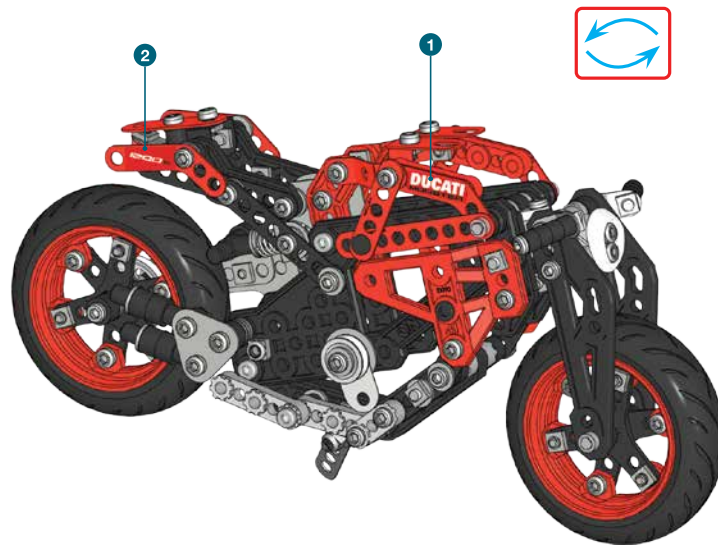
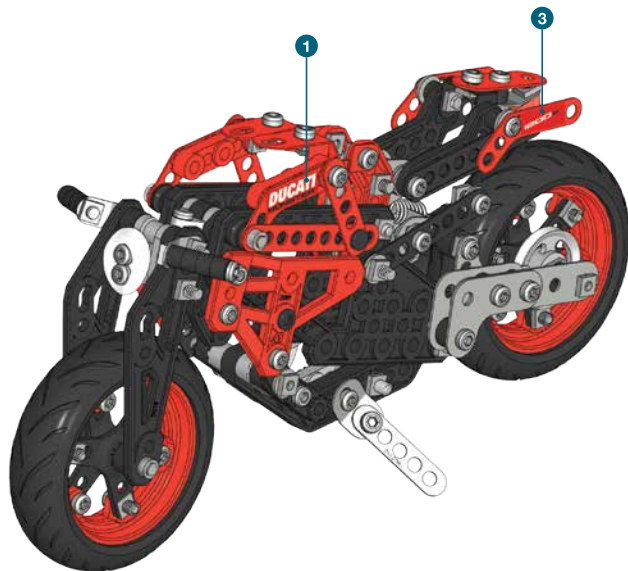

| | | | | | |
|--|----------------|--|------------------------|--|---------------------------|
| | D032 x2 | | A105 (0005) x1 | | A120 (0120E) x2 |
| | B015 x1 | | C771 x2 | | A133 (0133A) x2 |
| | D018 x2 | | C771 x2 | | A277 (0077) x1 |
| | D089 x1 | | C770 x2 | | A811 (0811) x1 |
| | D090 x1 | | C768 x2 | | A506 (0006A) x1 |
| | D035 x4 | | C768 x1 | | A825 (0825) x2 |
| | C879 x1 | | C775 x2 | | A713 (0012D) x2 |
| | D091 x1 | | C775 x4 | | A353 (0120C) x1 |
| | D034 x2 | | C776 x1 | | A423 (0260F) x1 |
| | D033 x2 | | A367 (0133B) x2 | | A419 (0260B) x2 |
| | A626 x1 | | A548 (0048E) x1 | | A712 (0012C) x1 |
| | A538 x1 | | A260 (0260J) x2 | | C483 x3 |
| | A524 x1 | | A260 (0260I) x2 | | C330 x2 |
| | x1 | | A420 (0260C) x3 | | A623 (0023C3P1) x2 |
| | | | A420 (0260C) x2 | | A238 (0038A) x18 |
| | | | A420 (0260C) x2 | | A359 (0059A) x3 |
| | | | C868 x3 | | A338 (0038B) x28 |
| | | | C863 x1 | | A259 (0059C) x4 |
| | | | A010 (0010) x1 | | |



| | | |
|--|-----------------------|-------------------------|
| | 50 mm 1 15/16" | A017 (0017) x1 |
| | 40 mm 1 9/16" | A918 (0018A) x1 |
| | B6 44,5 mm 1 3/4" | C379 x2 |
| | B5 38,1 mm 1 1/2" | B696 x6 |
| | B4 32 mm 1 1/4" | C935 x3 |
| | S5 25,4 mm 1" | A912 (0111E) x1 |
| | B3 23 mm 15/16" | A347 (0147E) x5 |
| | B2 19 mm 3/4" | A447 (0147F) x2 |
| | B1 14,7 mm 37/64" | A247 (0147D) x7 |
| | S3 12 mm 1/2" | A411 (0111A) x5 |
| | S2 9,5 mm 3/8" | A511 (0111C) x25 |
| | S1 5,8 mm 15/64" | A637 (0037B) x7 |
| | D2 13,05 mm 17/32" | D047 x2 |
| | D1 11,25 mm 7/16" | D005 x2 |
| | | A337 (0037A) x56 |
| | | A737 (0037H) x5 |
| | | A138 (0038) x28 |
| | | C994 x1 |
| | | C993 x1 |

GB. Remove all packaging before use. Retain this information, addresses and phone numbers for future reference. Content may vary from pictures. Meccano reserves the right to discontinue the website www.meccano.com at any time. An adult should periodically check this toy to ensure no damage or hazards exist, if so, remove from use. Children should be supervised during play.

F. Retirer tout l'emballage avant utilisation. Conserver les informations, adresses et numéros de téléphone pour consultation ultérieure. Le contenu peut différer des images. Meccano se réserve le droit de supprimer le site Internet www.meccano.com à tout moment. Un adulte doit régulièrement examiner ce jouet afin de s'assurer qu'il ne présente pas de dommage ni de risque. En cas de problème, ne plus l'utiliser. Les enfants doivent être surveillés lorsqu'ils jouent.

E. Retire todo el embalaje antes de utilizar el producto. Conserve toda la información, las direcciones y los números de teléfono para futuras referencias. El contenido del paquete puede no corresponder con las imágenes. Meccano se reserva el derecho a suspender el sitio web www.meccano.com en cualquier momento. Un adulto debe revisar de forma periódica el juguete para asegurarse de que no supone un riesgo o peligro para el niño; si así fuera el caso, interrumpa su uso. Supervise a los niños mientras juegan con el producto.

- ⚠ Warning: CHOKING HAZARD – Small parts.
- ⚠ Attention ! RISQUE D'ÉTOUFFEMENT – Contient de petits éléments.
- ⚠ Advertencia: PELIGRO DE ASFIXIA – Contiene piezas pequeñas. No conveniente para niños menores de 3 años.
- ⚠ Achtung: ERSTICKUNGSGEFAHR – Kleinteile.
- ⚠ Waarschuwing: VERSTIKKINGSGEVAAR – Kleine onderdelen.
- ⚠ Attenzione: RISCHIO DI SOFFOCAMENTO – Pezzi piccoli.
- ⚠ Aviso: PERIGO DE ASFIXIA – Peças pequenas.
- ⚠ Осторожно! ОПАСНОСТЬ УДУШЬЯ – Мелкие детали.



NORTH AMERICA – 1-800-622-8339, customercare@spinmaster.com
UK – 0800 206 1191, serviceuk@spinmaster.com
IRELAND: 1800 992 249
FRANCE – 0800 909 150, servicefr@spinmaster.com
DEUTSCHLAND – 00800 0101 0222, Kundenservice@spinmaster.com
SCHWEIZ – 0800 561 350 • **ÖSTERREICH** – 0800 297 267
NEDERLAND – 0800 022 3683, klantenservice@spinmaster.com
BELGIË/BELGIQUE – 0800 77 688 • **LUXEMBOURG** – 800 2 8044
ITALIA – 800 788 532, servizio@spinmaster.com
MEXICO – 55 4160 7947, servicio@spinmaster.com



WWW.SPINMASTER.COM

D. Entfernen Sie vor der Benutzung sämtliche Verpackungsmaterialien. Alle Informationen, Adressen und Telefonnummern bitte für mögliche Rückfragen aufbewahren. Der Packungsinhalt kann von den Bildern abweichen. Meccano behält sich das Recht vor, den Betrieb der Website www.meccano.com jederzeit einzustellen. Ein Erwachsener sollte regelmäßig sicherstellen, dass das Spielzeug keine Gefahr darstellt, und es gegebenenfalls entfernen. Kinder sollten beim Spielen beaufsichtigt werden.

NL. Verwijder de verpakking voor gebruik. Bewaar deze informatie, adressen en telefoonnummers voor toekomstig gebruik. Inhoud kan afwijken van illustraties. Meccano behoudt zich het recht voor de website www.meccano.com wanneer gewenst buiten gebruik te stellen. Een volwassene dient dit speelgoed regelmatig te controleren. In geval van schade of gevaaren het speelgoed niet meer gebruiken. Houd toezicht als kinderen spelen.

I. Rimuovere l'imballo prima dell'uso. Conservare informazioni, indirizzi e numeri di telefono per riferimento futuro. Il prodotto potrebbe essere differente dalle immagini. Meccano si riserva il diritto di rimuovere il sito www.meccano.com in qualsiasi momento. Il giocattolo deve essere periodicamente controllato da un adulto per prevenire eventuali danni o rischi; in caso di danno, sospendere l'uso. I bambini devono essere sorvegliati durante il gioco.

P. Remova totalmente a embalagem antes de utilizar. Guarde todos os endereços, números de telefone e demais informações para consulta e referência. O conteúdo poderá ser diferente das ilustrações. A Meccano reserva-se o direito de descontinuar o site www.meccano.com a qualquer altura. Um adulto deve verificar o brinquedo periodicamente para garantir que não há danos ou riscos. Se houver, é necessário que o brinquedo seja retirado de uso. Crianças devem ser supervisionadas enquanto brincam.

R. Снимите все упаковочные материалы перед использованием. Запишите указанные на упаковке адреса и номера телефонов, чтобы у вас была возможность связаться с нами. Содержимое упаковки может отличаться от иллюстрации. Компания Meccano оставляет за собой право прекратить использование сайта www.meccano.com в любое время. Взрослым следует время от времени проверять игру и следить за тем, чтобы она не была сломана и не представляла опасности для ребенка. В противном случае ее не следует использовать. Во время игры дети должны находиться под присмотром взрослых.

- ⚠ CAUTION: Stickers not intended to be placed on skin.
- ⚠ MISE EN GARDE : Les autocollants ne sont pas destinés à être placés sur la peau.
- ⚠ PRECAUCIÓN: Las calcomanías no deben colocarse sobre la piel.
- ⚠ ACHTUNG: Sticker sind nicht zum Aufkleben auf die Haut geeignet.
- ⚠ VOORZICHTIG: Stickers zijn niet voor op de huid bedoeld.
- ⚠ ATTENZIONE: Non applicare gli adesivi sulla pelle.
- ⚠ ATENÇÃO: os autocolantes não devem ser colocados na pele.
- ⚠ ОСТОРОЖНО: Стикеры не предназначены для приклеивания к коже.

SPIN MASTER LTD., 450 FRONT STREET WEST, TORONTO, ON M5V 1B6 CANADA.
DISTRIBUTED IN EU BY SPIN MASTER INTERNATIONAL, S.A.R.L.,
16 AVENUE PASTEUR, L-2310, Luxembourg. www.spinmaster.com



TM & © 2015 MECCANO for packaging, instructions and models built with this set. / TM & © 2015 MECCANO pour l'emballage, les notices et modèles de ce coffret. / © MECCANO is an exclusive trademark of MECCANO. Spin Master logo is a trademark of Spin Master Ltd. / © MECCANO est une marque de commerce exclusive de MECCANO. Le logo de Spin Master est une marque de commerce de Spin Master Ltd. / All rights reserved. / Tous droits réservés.

T91807_0002_20071489_GML_IB_R1 W_MEC_Monster