

MECCANOTM
M A K E R S Y S T E M

AERIAL RESCUE
SECOURS AÉRIEN

16211



 **8+**

Instructions
Notice de montage
Instrucciones de construcción
Bauanleitung

Bouwinstructie
Istruzioni
Instruções
Инструкции





CONSTRUCTION TIPS / ASTUCES DE CONSTRUCTION

TIPS DE CONSTRUCCIÓN / TIPPS ZUM BAUEN
MONTAGETIPS / SUGGERIMENTI PER COSTRUIRE
DICAS DE MONTAGEM / РЕКОМЕНДАЦИИ ПО СБОРКЕ

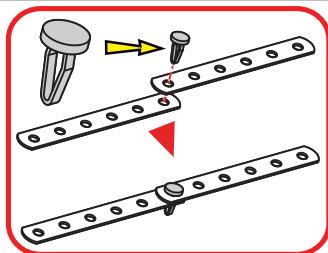
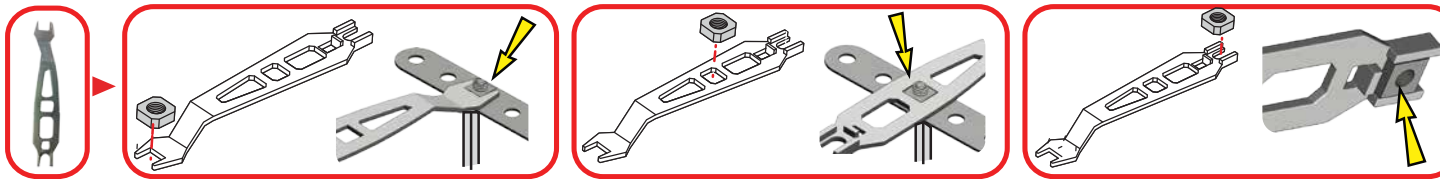
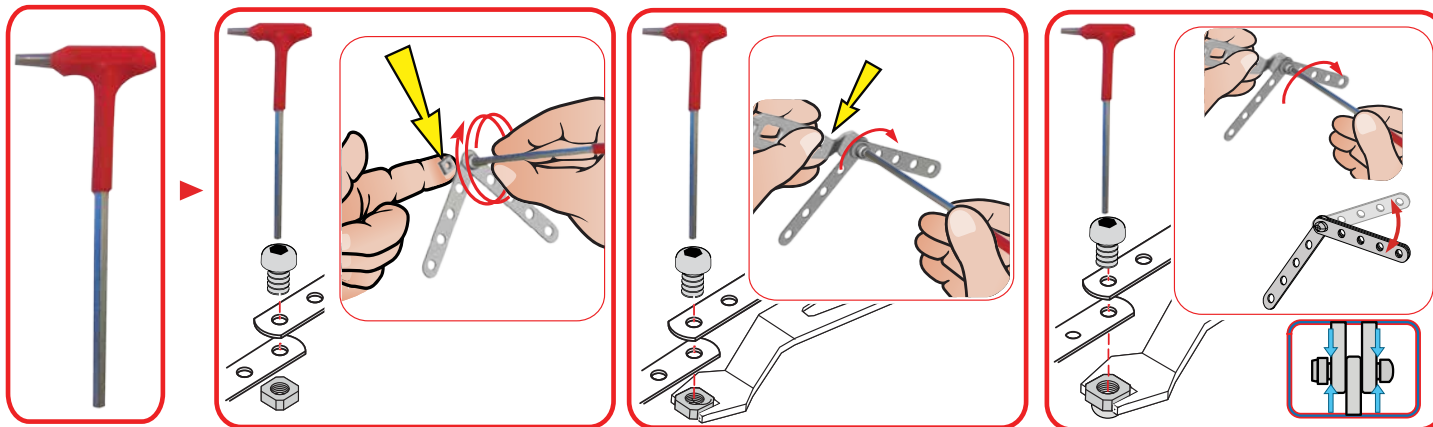
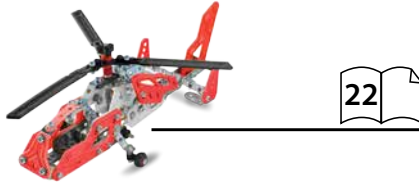

TABLE OF CONTENTS / SOMMAIRE

ÍNDICE / INHALTSVERZEICHNIS / INHOUD / INDICE / ÍNDICE / СОДЕРЖАНИЕ



AVAILABLE ONLINE / DISPONIBLES EN LIGNE
 DISPONIBLES EN LÍNEA / ONLINE VERFÜGBAR /
 ONLINE VERKRIJGBAAR / DISPONIBILI ONLINE /
 DISPONÍVEL ONLINE / ДОСТУПНЫ В
 ОНЛАЙН-МАГАЗИНЕ



EN. Content : 406 parts, 2 real tools and 1 instruction sheet for 3 models.
FR. Contenu : 406 pièces, 2 vrais outils et 1 notice de montage pour 3 modèles.
ES. Contenido : 406 piezas, 2 herramientas reales y 1 guía de instrucciones para 3 modelos.
DE. Inhalt: 406 Teile, 2 echte Werkzeuge und 1 Bauanleitung für 3 Modelle.
NL. Inhoud : 406 onderdelen, 2 stuks gereedschap en 1 bouw instructie voor 3 modellen.
IT. Contenuto : 406 pezzi, 2 attrezzi e 1 guida per l'uso per 3 modelli.
PT. Conteúdo: 406 peças, 2 ferramentas reais e 1 folha de instruções para 3 modelos.
RU. В коробке: 406 деталей, 2 настоящих инструмента и 1 инструкция по сборке 3 моделей.

Building instructions for the 17 other models are available at www.meccano.com.
FR. Les notices de montage des 17 autres modèles sont disponibles sur www.meccano.com.
ES. Hay instrucciones de construcción disponibles para los otros 17 modelos en www.meccano.com.
DE. Bauanleitungen für die anderen 17 Modelle sind auf www.meccano.com zu finden.
NL. Bouwinstructies voor de andere 17 modellen zijn beschikbaar op www.meccano.com.
IT. Le istruzioni di montaggio degli altri 17 modelli sono disponibili alla pagina www.meccano.com.
PT. Instruções de montagem dos restantes 17 modelos disponíveis em www.meccano.com.
RU. Инструкции по сборке 17 других моделей можно найти на сайте www.meccano.com.

EN. Only one model can be built at a time. **FR.** Les pièces fournies ne permettent de monter qu'un seul modèle à la fois. **ES.** Solo es posible construir un modelo a la vez. **DE.** Jeweils nur eins der Modelle baubar. **NL.** Er kan maar een model tegelijk worden gebouwd. **IT.** Permette di realizzare un solo modello per volta. **PT.** Só é possível montar um modelo de cada vez. **RU.** Одновременно можно построить только одну модель.





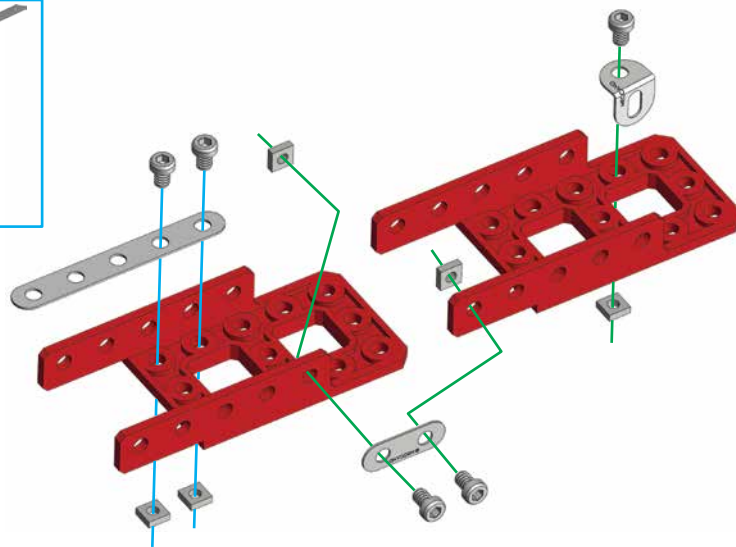

1

- | | | |
|--|------------------|----|
| | 5,8 mm
15/64" | x5 |
| | | x5 |
| | | x1 |
| | | x1 |
| | | x1 |
| | | x2 |









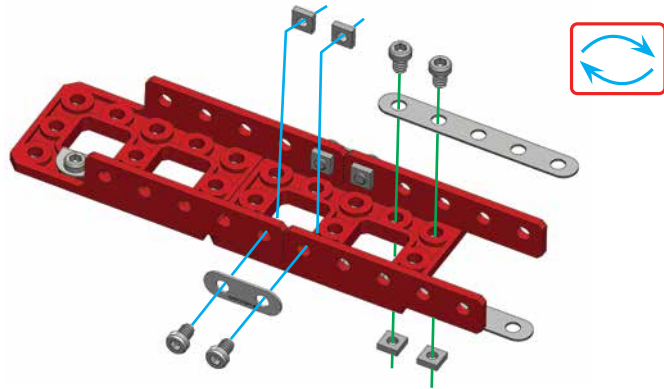

2



	S1	5,8 mm 15/64"	x4
			x4
			x1
			x1

	S1	1:1
---	----	-----









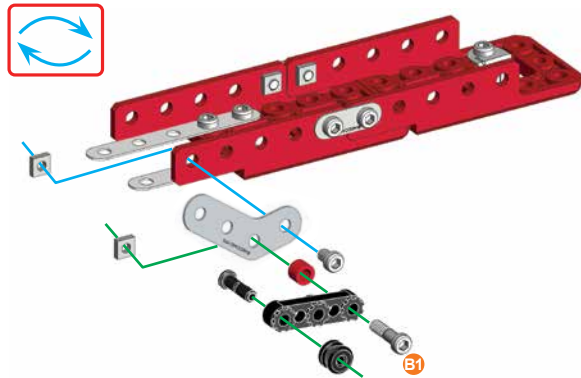

3





	S1	5,8 mm 15/64"	x1
	B1	14,7 mm 37/64"	x1
			x2
	A338	x1	
			x1
			x1
			x1
			x1

	A338		
	B1	1:1	
	S1		









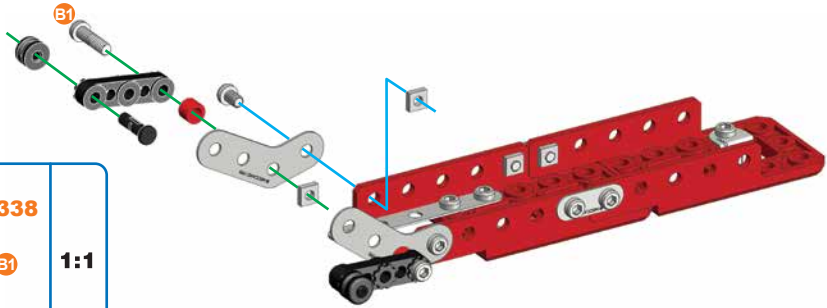

4







-  **S1** | 5,8 mm | **x1**
15/64"
-  **B1** | 14,7 mm | **x1**
37/64"
-  **x2**
-  **A338x1**
-  **x1**
-  **x1**
-  **x1**
-  **x1**

		A338	1:1
		B1	
		S1	









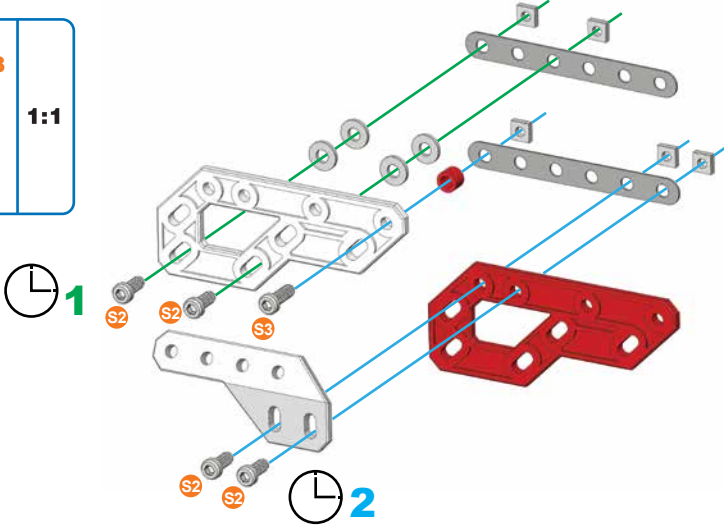



5



-  **S2** | 9,5 mm | **x4**
3/8"
-  **S3** | 12 mm | **x1**
1/2"
-  **x5**
-  **A338x1**
-  **x4**
-  **x2**
-  **x1**
-  **x1**
-  **x1**

		A338	1:1
		S2	
		S3	



6



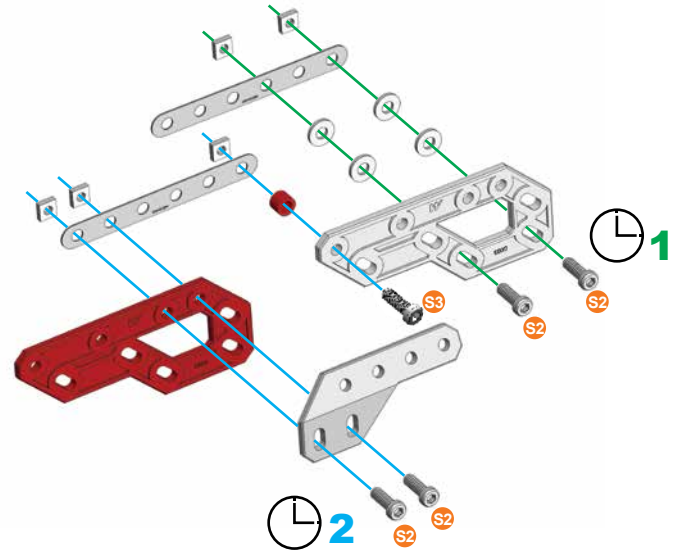

	9.5 mm 3/8"	x4
	12 mm 1/2"	x1
		x5
	A338	x1
		x4
		x2
		x2
		x1
		x1
		x1

	A338	1:1
	S2	
	S3	



7

④+⑥+



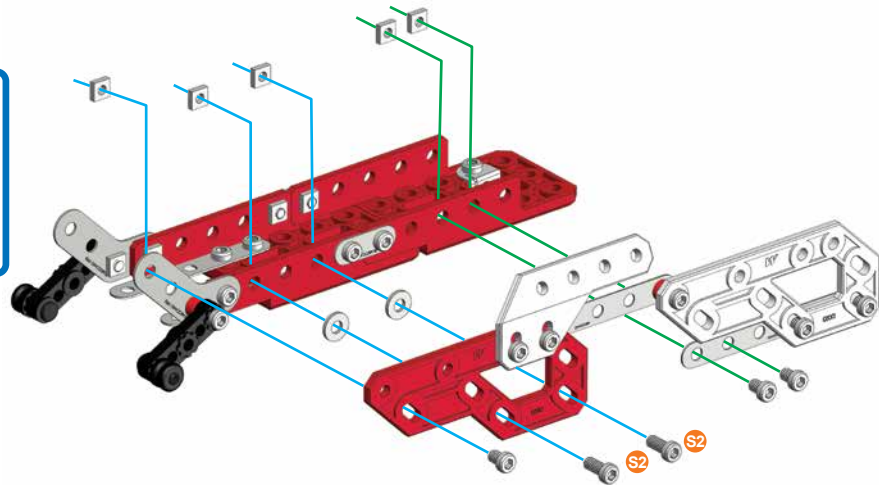

	5.8 mm 15/64"	x3
	9.5 mm 3/8"	x2
		x5
		x2

	S2	1:1
	S1	



8





⑤+⑦+

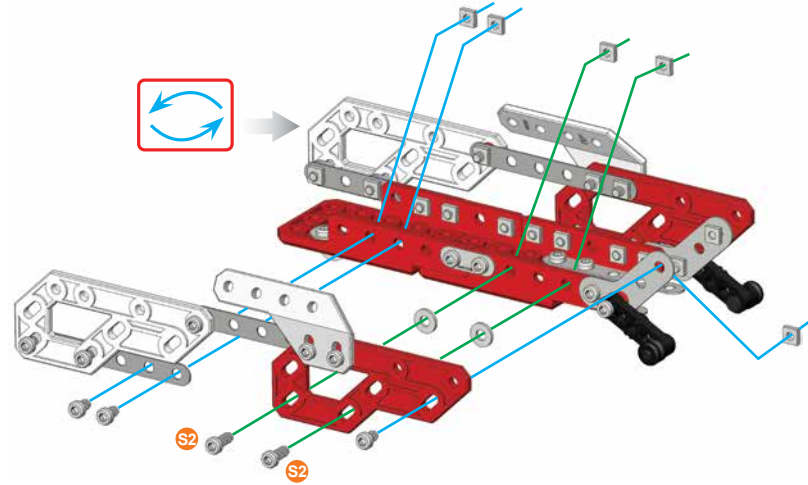

	S1	5,8 mm 15/64"	x3
	S2	9,5 mm 3/8"	x2
			x5
			x2

	S2	1:1
	S1	



9

		x2
	A238x1	
		x2
		x1
	63,5 mm 2 31/64"	x1

		A238	1:1
			

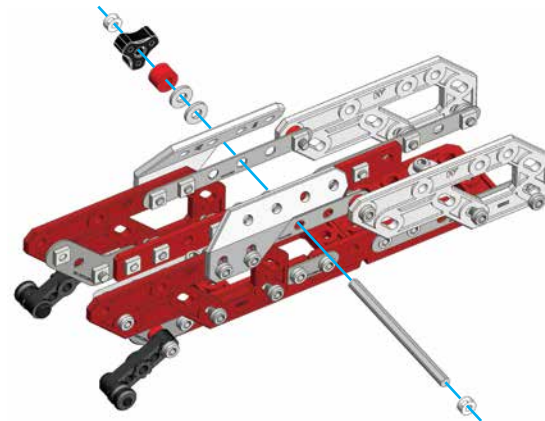

10



x1

x1



11

⑨+⑩+



x1

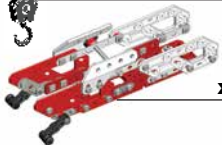

x1

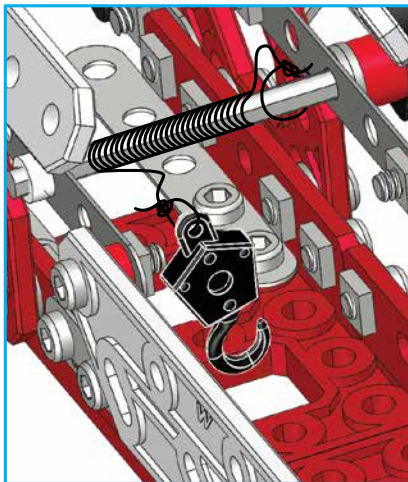
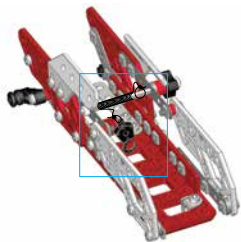

12



S1 5.8 mm | 15/64"

x4



x4



x2



x1





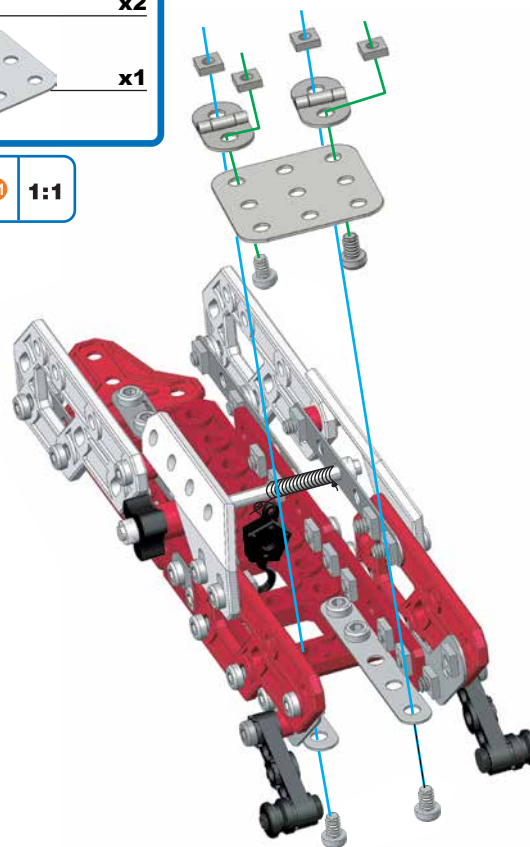

S1

1:1







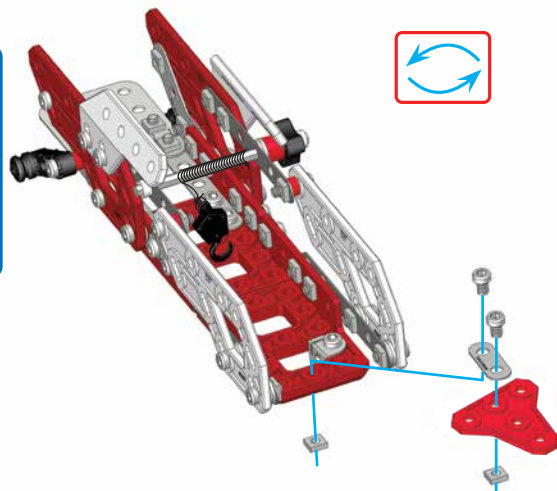

13

-  | 5,8 mm | 15/64" | **x2**
-  | **x2**
-  | **x1**
-  | **x1**

-  | **S1** | **1:1**





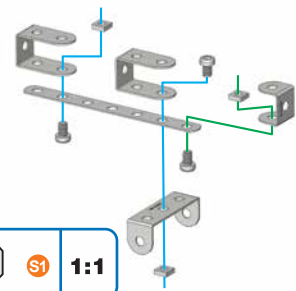

14

-  | 5,8 mm | 15/64" | **x3**
-  | **x3**
-  | **x1**
-  | **x2**
-  | **x1**
-  | **x1**

-  | **S1** | **1:1**







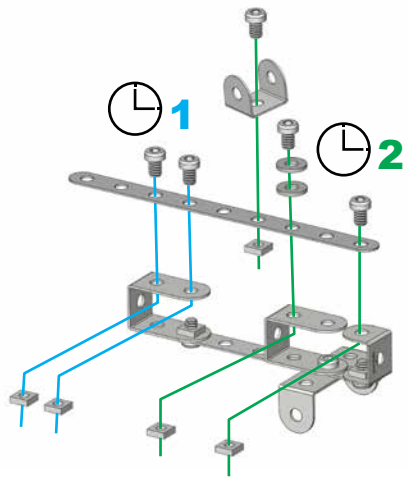

15

-  | 5,8 mm | 15/64" | **x5**
-  | **x5**
-  | **x2**
-  | **x1**
-  | **x1**

-  | **S1** | **1:1**





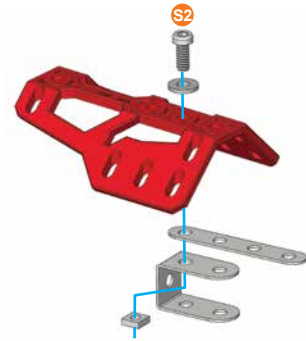

16

-  | 9,5 mm | 3/8" | **x1**
-  | **x1**
-  | **x1**
-  | **x1**
-  | **x1**
-  | **x1**

-  | **S2** | **1:1**





17

	5.8 mm 15/64"	x3
		x3
		x3
		x1
		x1

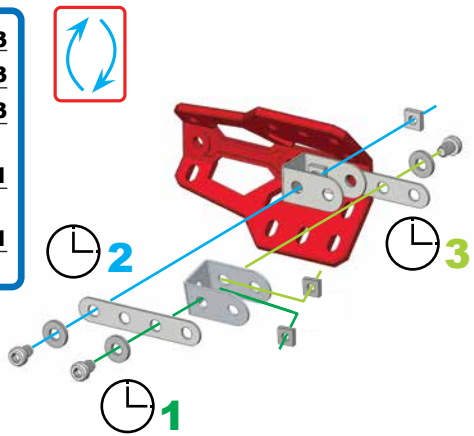
	1:1
---	-----



18

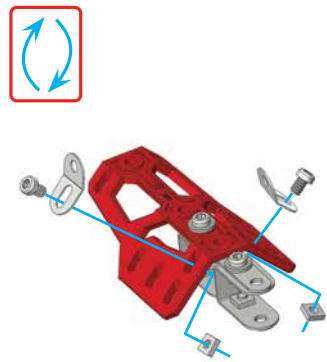

	5.8 mm 15/64"	x2
		x2
		x2

	1:1
---	-----



19



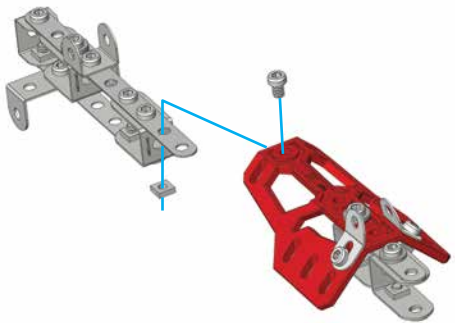

(15)+(18)+

	5.8 mm 15/64"	x1
		x1

	1:1
---	-----







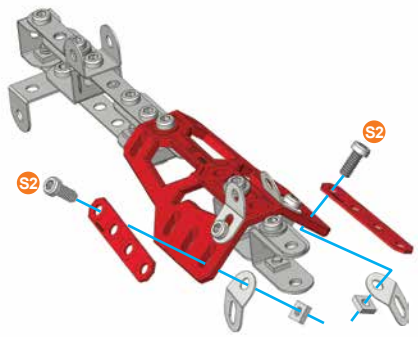

20

	9.5 mm 3/8"	x2
		x2
		x2
		x2

	1:1
--	-----



21

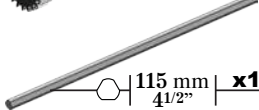

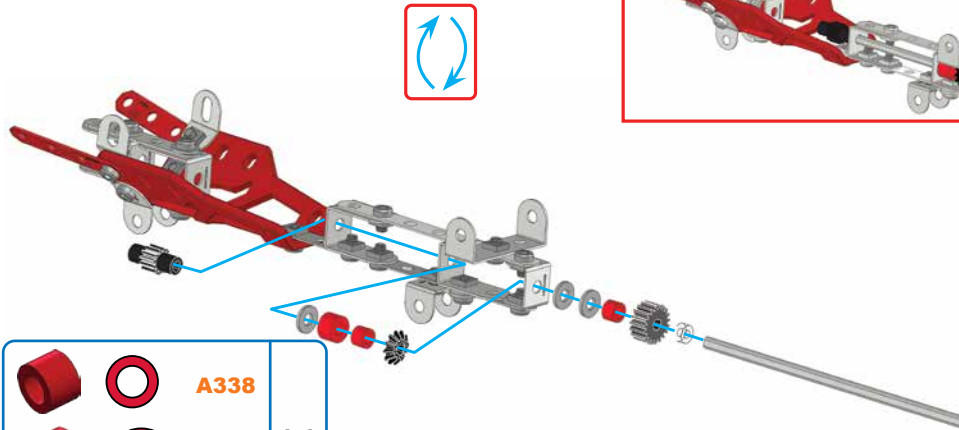
-  **x3**
-  **x1**
-  **x1**
-  **A238x1**
-  **A338x2**
-  **x1**
-  **x1**
-  **115 mm**
4 1/2" **x1**

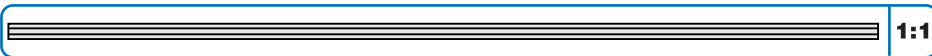

- | | | | |
|---|---|-------------|------------|
|  |  | A338 | 1:1 |
|  |  | A238 | |

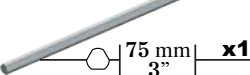

22

-  **x2**
-  **A338x2**
-  **x1**
-  **75 mm**
3" **x1**

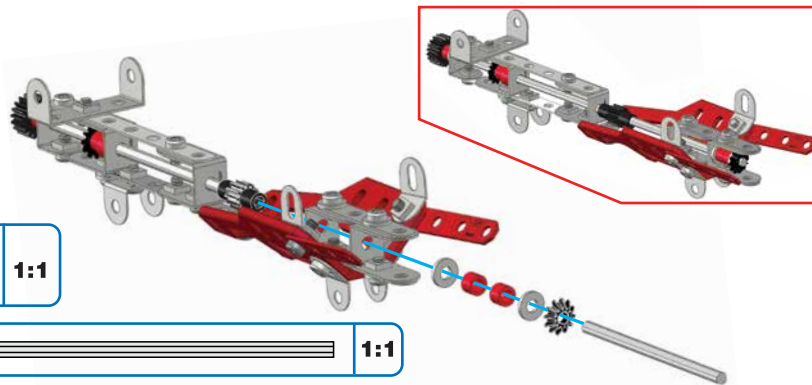



- | | | | |
|---|---|-------------|------------|
|  |  | A338 | 1:1 |
|---|---|-------------|------------|



23



⑬+⑳+

	S1	5.8 mm	x2
		15/64"	
			x2

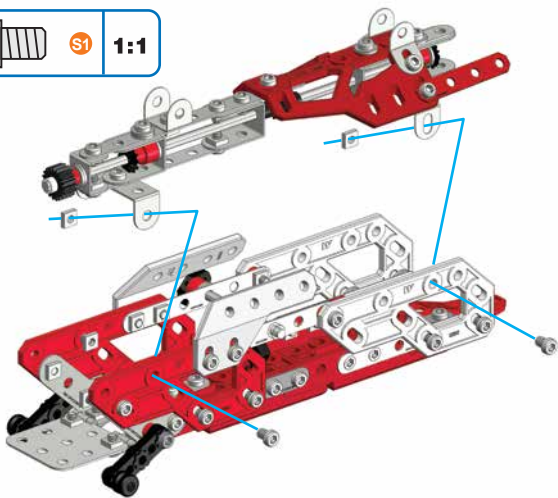
	S1	1:1
---	----	-----





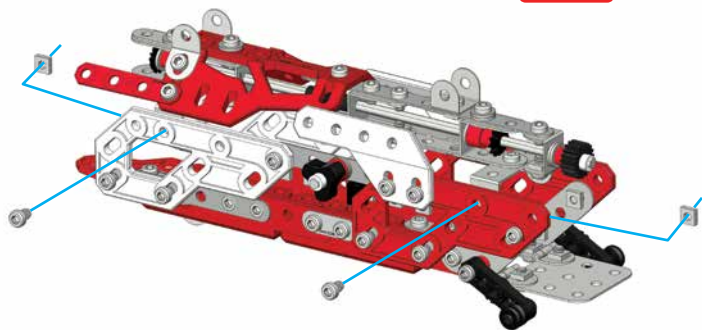

24

	S1	5.8 mm	x2
		15/64"	
			x2

	S1	1:1
---	----	-----







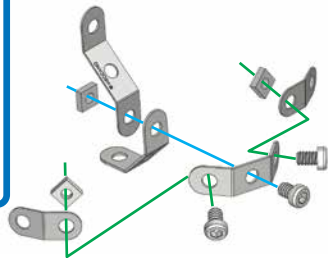

25

	S1	5.8 mm	x3
		15/64"	
			x3
			x2
			x2
			x1

	S1	1:1
---	----	-----



26

	S1	5.8 mm	x1
		15/64"	
			x1
			x3
			x1
			x2
			x3

	S1	1:1
---	----	-----

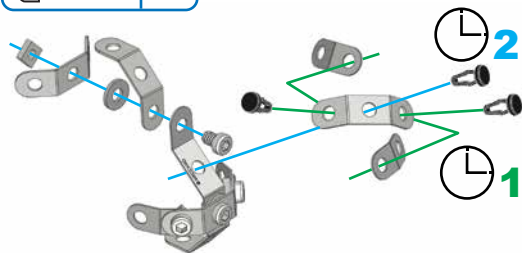

27

24+26+

- S1** | 5.8 mm | **x1**
15/64"
- x1**
- x1**

S1 | **1:1**

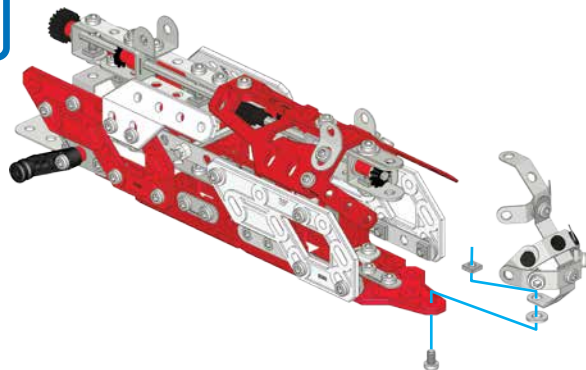

28

- S2** | 9.5 mm | **x6**
3/8"
- x6**
- x6**
- x2**
- x6**

S2 | **1:1**



x2

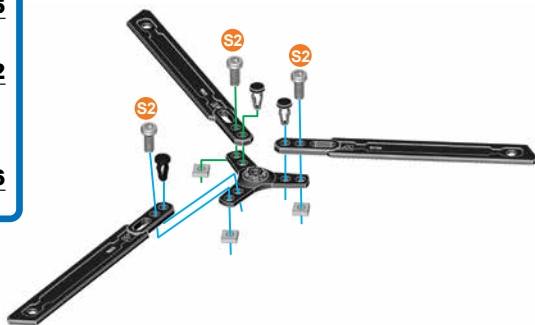

29

27+28+

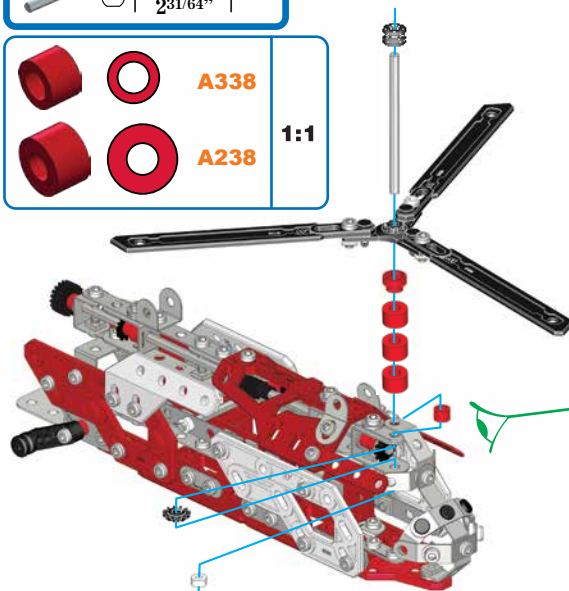
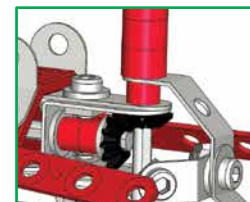

- x1**
- A338x1**
- A238x3**
- x1**
- x1**
- x1**
- x1**
- 63.5 mm** | **x1**
2 31/64"

- A338**
 - A238**
- 1:1**



1:1



30

	S1 5,8 mm 15/64"	x2
		x2

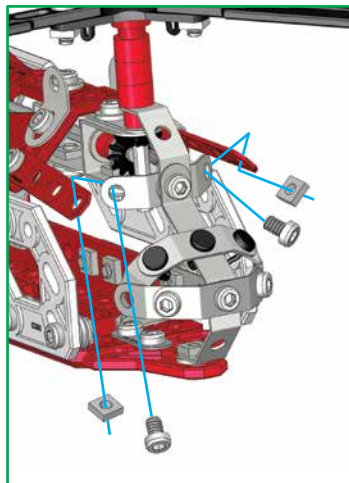
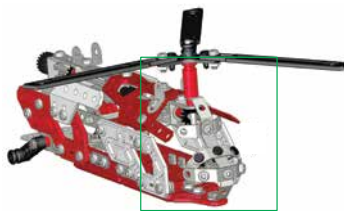
	S1 1:1
---	------------------------





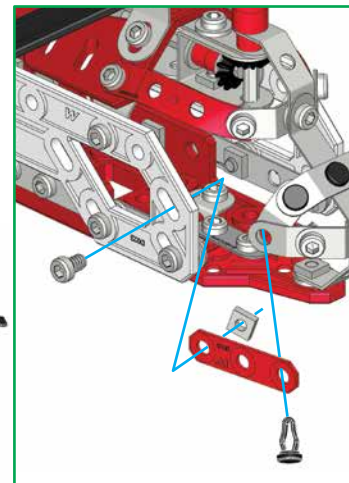
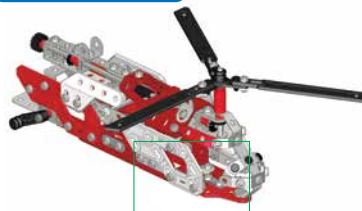

31

	S1 5,8 mm 15/64"	x1
		x1
		x1
		x1

	S1 1:1
--	------------------------





32

	S1 5,8 mm 15/64"	x1
		x1
		x1
		x1

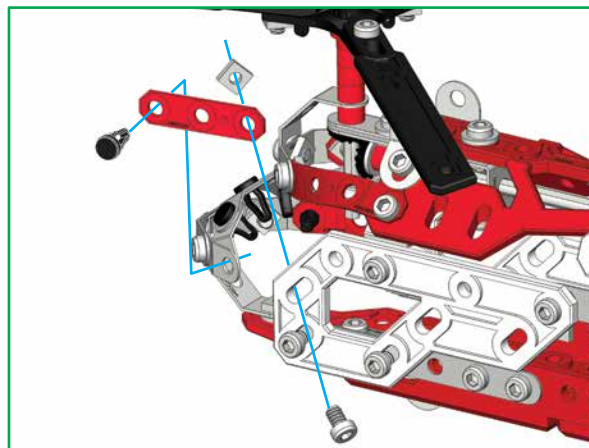
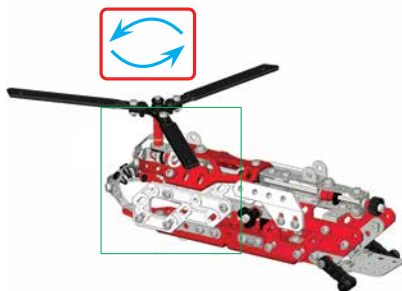
	S1 1:1
---	------------------------







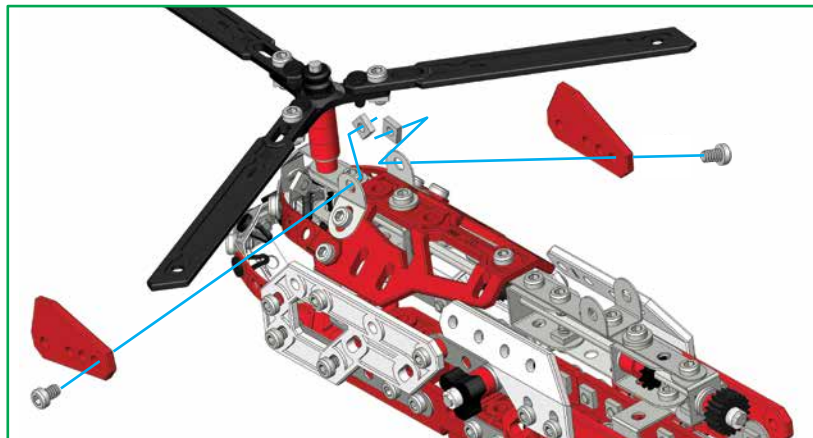

33





 S1	5.8 mm 15/64"	x2
		x2
		x2

	S1	1:1
---	----	------------



34

 S1	5.8 mm 15/64"	x2
 S3	12 mm 1/2"	x2
		x4
	A338x2	
		x2
		x1

		A338	
	S3		1:1
	S1		

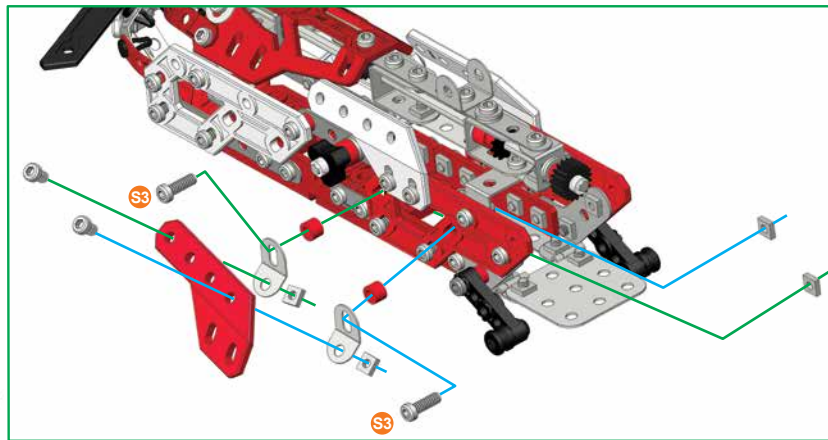

35

- | 5,8 mm | x2
15/64"
- | 12 mm | x2
1/2"
- | x4
- A338x2**
- | x2
- | x1

- A338**
- | **S3** | **1:1**
- | **S1**

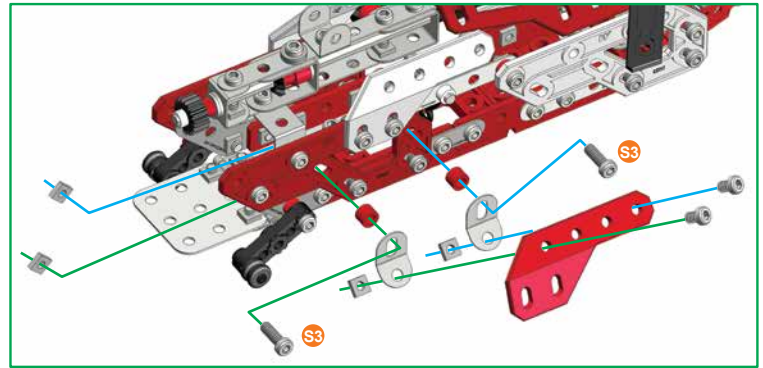
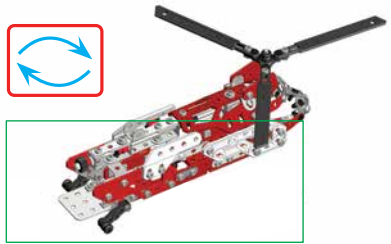

36

- | 9,5 mm | x2
3/8"
- | x2
- | x4
- | x1
- | x1

- | **S2** | **1:1**

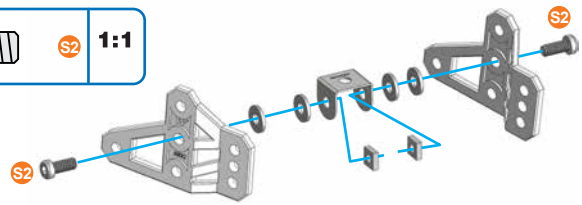

37

- | x1
- | x1
- A238x2**
- | x1
- | x1
- | x1
- | 63,5 mm | x1
2 31/64"

- A238** | **1:1**

- | **1:1**

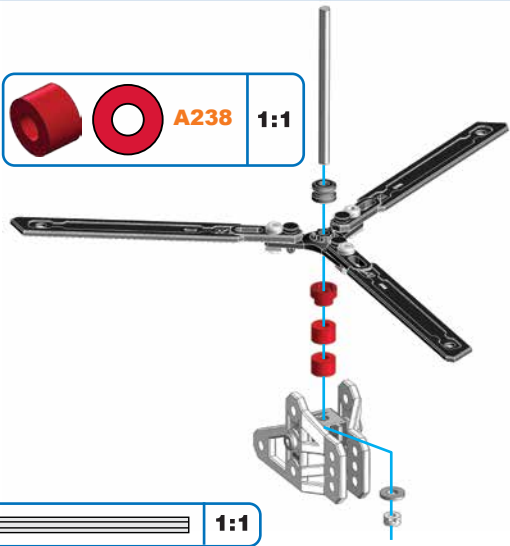



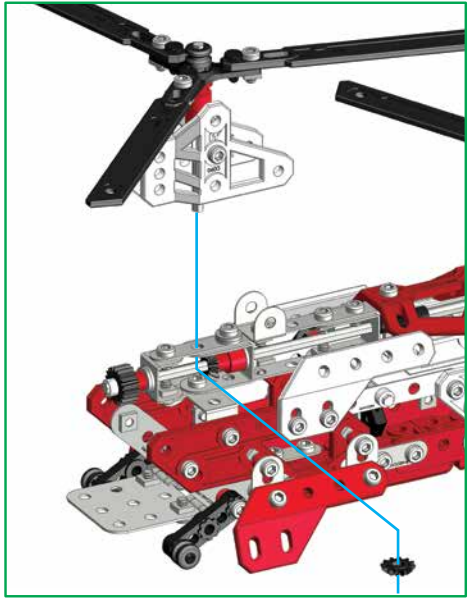
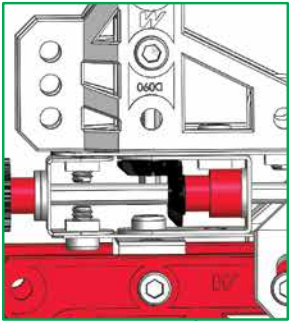

38 (35)+(37)+

	x1
---	-----------





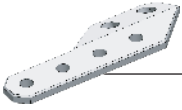

39

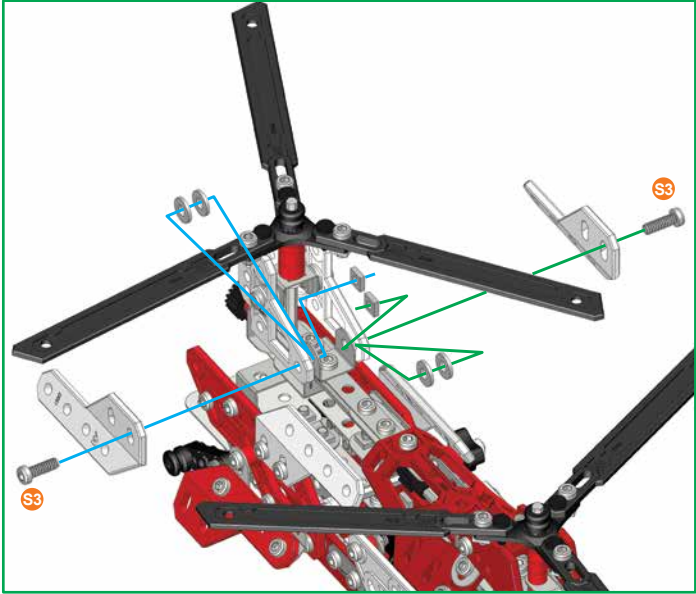
	12 mm	x2
	1/2"	x2
		x4
		x1
		x1

	1:1
---	------------



40

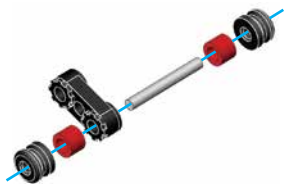

	A338x2
	x2
	x1
	25 mm 1" x1

	A338	1:1
---	-------------	------------



41

39+40+





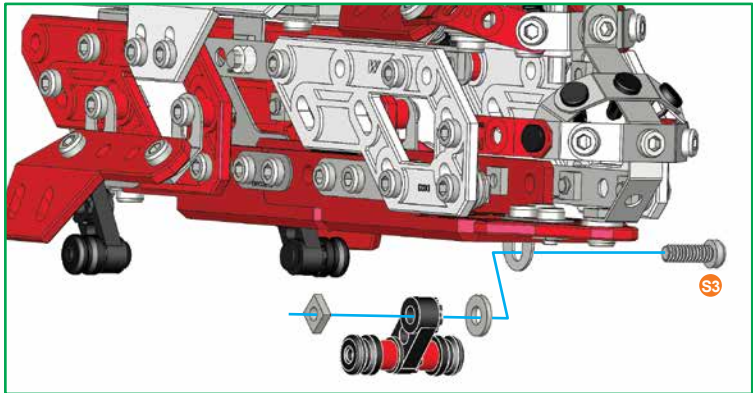

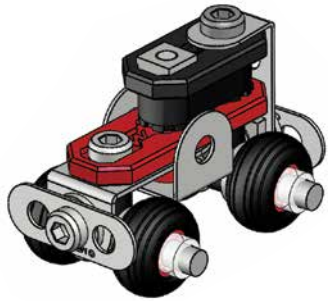
	S3 12 mm 1/2"	x1
		x1
		x1

	S3	1:1
--	-----------	------------







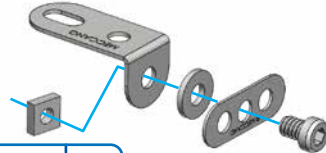

42

	5.8 mm 15/64"	x1		x1
		x1		x1
		x1		x1







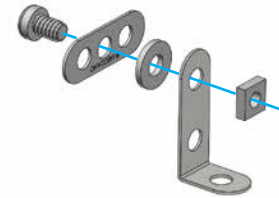





44

	5.8 mm 15/64"	x1		x1
		x1		x1
				x1



43

	23 mm 15/16"	x1		x1
		A338x1		x1
				x1
				x1
				x1

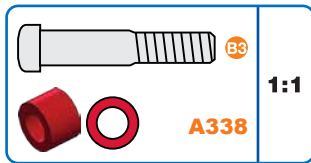
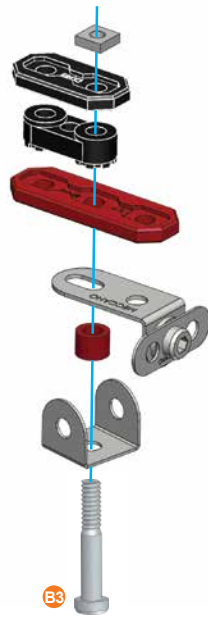



45

43+44+

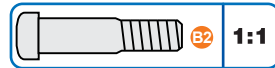
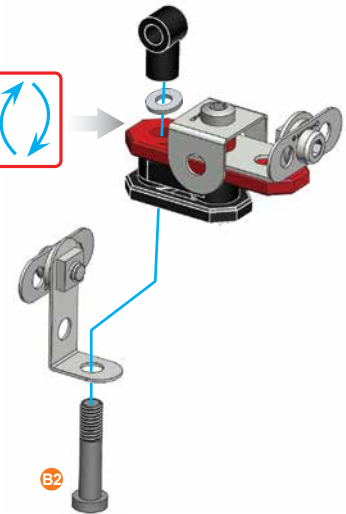
	19 mm 3/4"	x1		x1
		x1		x1





46

-  **5.8 mm** | **x1**
15/64"
-  **x1**

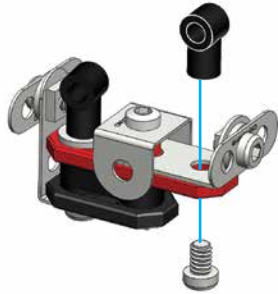
-  **1:1**



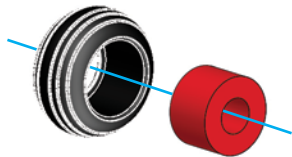

47

-  **A238x4**
-  **x4**



48

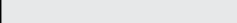

-  **32 mm** | **x2**
1 1/4"
-  **x8**
-  **x4**

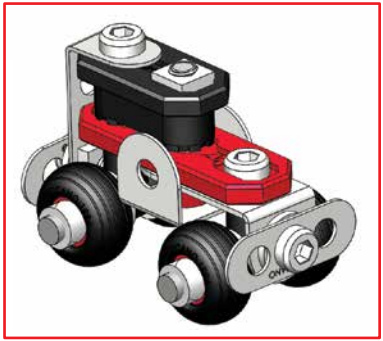
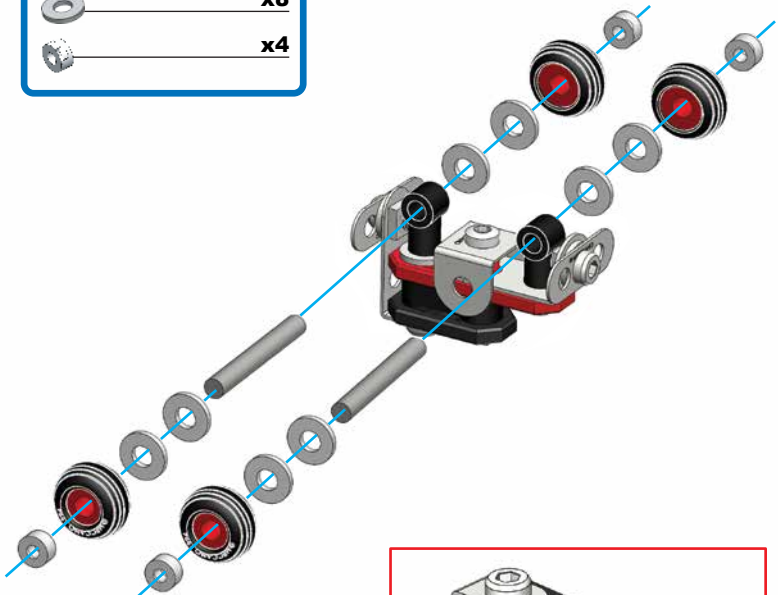
-  **1:1**





1

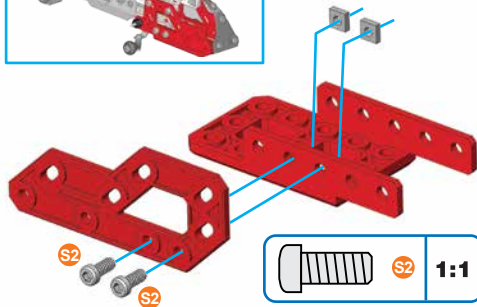
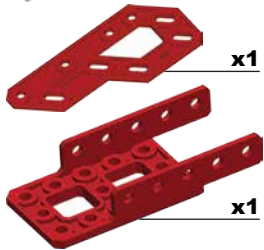

-  **S2** | 9.5 mm | **x2**
3/8"
-  **x2**

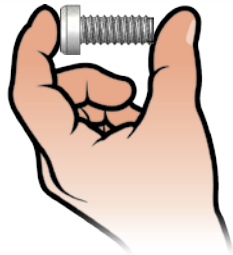

-  **S2** | **1:1**



2

-  **S2** | 9.5 mm | **x2**
3/8"
-  **x2**



-  **S2** | **1:1**

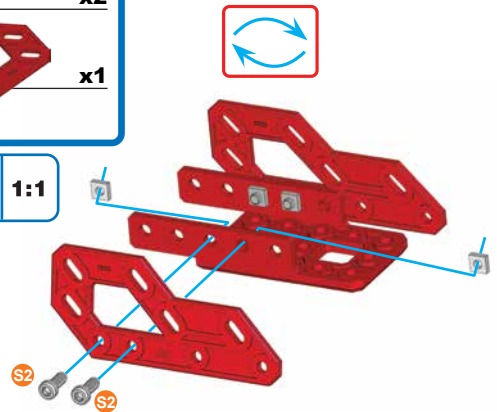

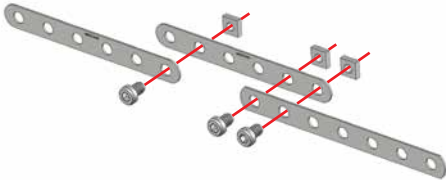
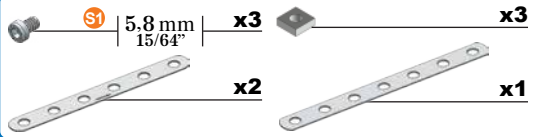
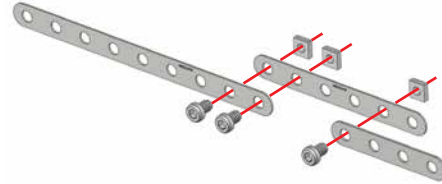
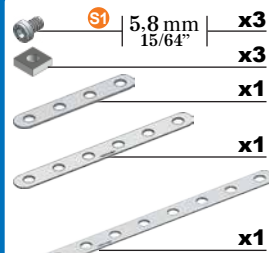

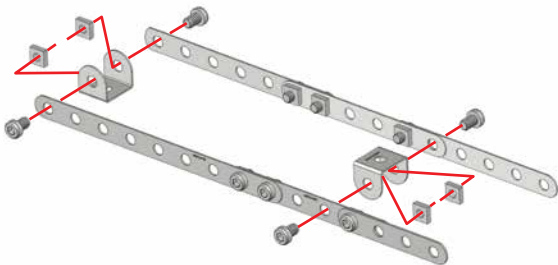
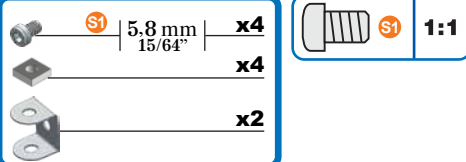
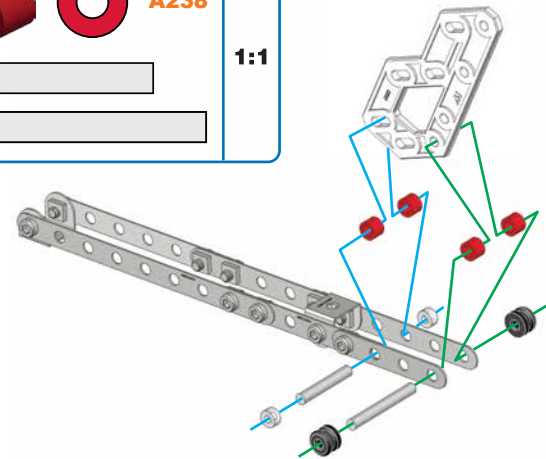
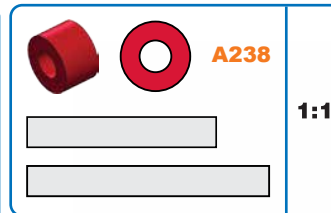
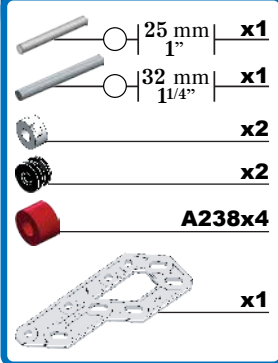

3**4****5**



③+④+

**6**



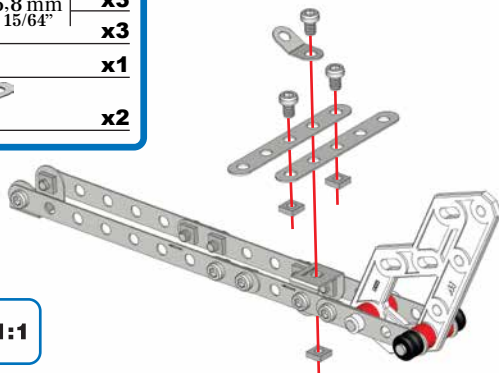

7

	5.8 mm 15/64"	x3
		x3
		x1
		x2

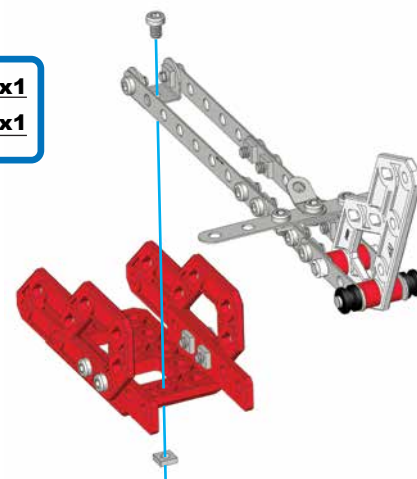

**8****②+⑦+**

	5.8 mm 15/64"	x1
		x1

**9**

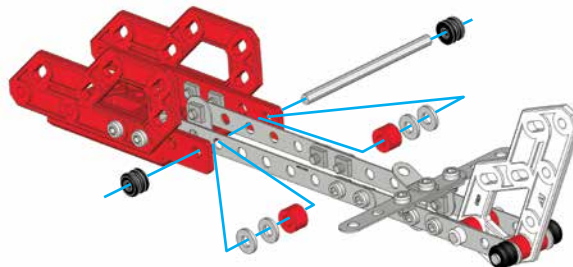
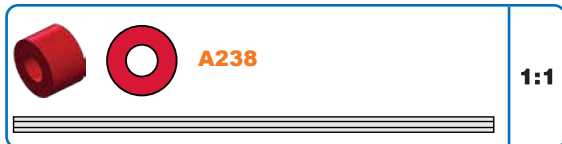

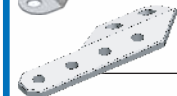

	63.5 mm 2 31/64"	x1
		x4
		x2
		A238x2

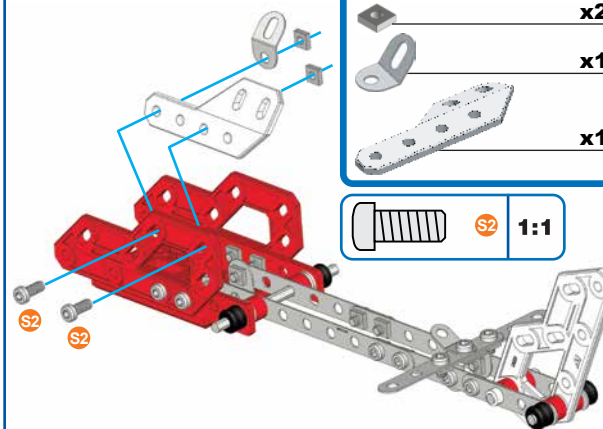
**10**

	9.5 mm 3/8"	x2
		x2
		x1
		x1



11

	9.5 mm 3/8"	x2
		x2
		x1
		x1

	1:1
---	-----

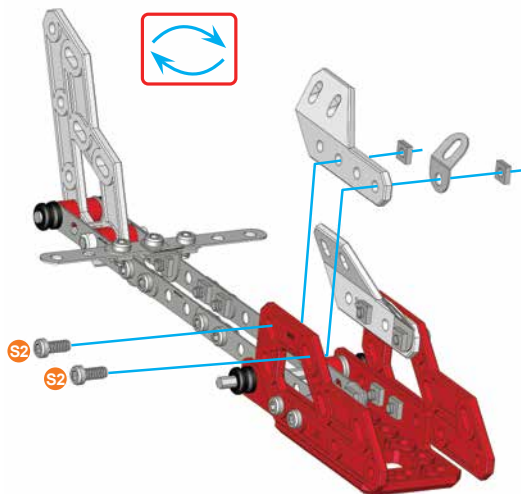



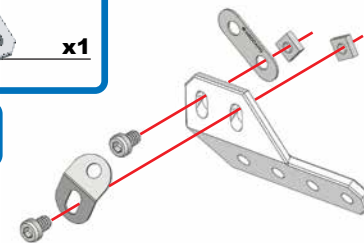

12

	5.8 mm 15/64"	x2
		x2
		x1
		x1

	1:1
---	-----



13

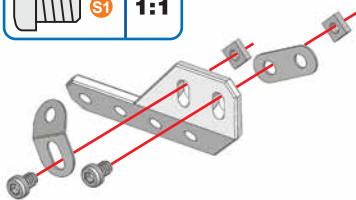

	5.8 mm 15/64"	x2
		x2
		x1
		x1

	1:1
--	-----



14

⑫+⑬+

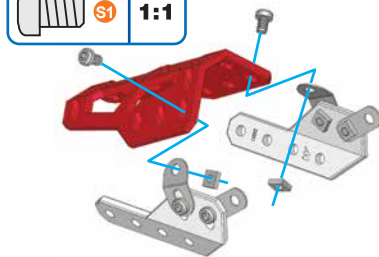

	5.8 mm 15/64"	x2
		x2
		x1

	1:1
---	-----



15

⑪+⑭+

	5.8 mm 15/64"	x3
		x3

	1:1
---	-----

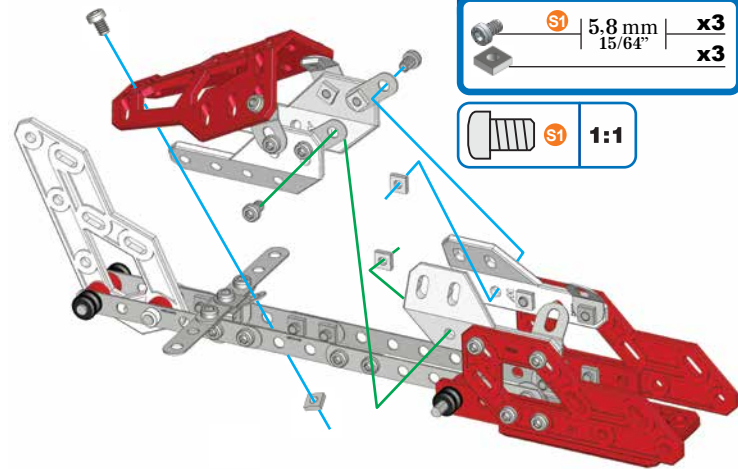

16

	S3	12 mm 1/2"	x2
	S2	9,5 mm 3/8"	x1
			x3
			x1
			x2
			x1
			x1
			x1
			x1

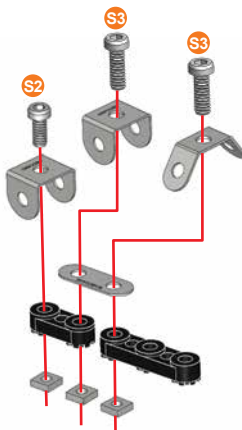
**17**

	S1	5,8 mm 15/64"	x2
			x2
			x2

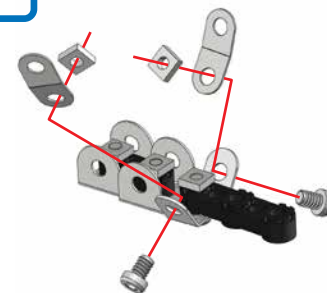
**18****15+17+**

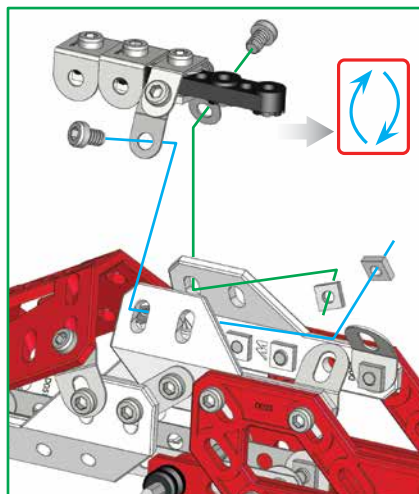
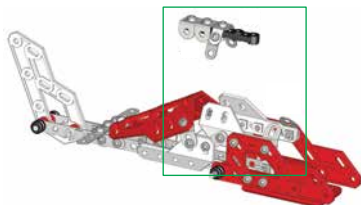

	S1	5,8 mm 15/64"	x2
			x2

**19**

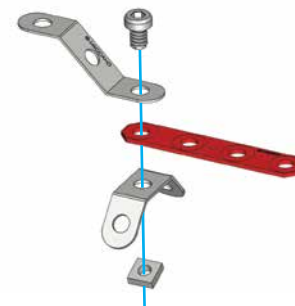
	S1	5,8 mm 15/64"	x1
			x1
			x1
			x1
			x1
			x1





20 (18)+(19)+

	9.5 mm 3/8"	x1
	5.8 mm 15/64"	x2
		x3

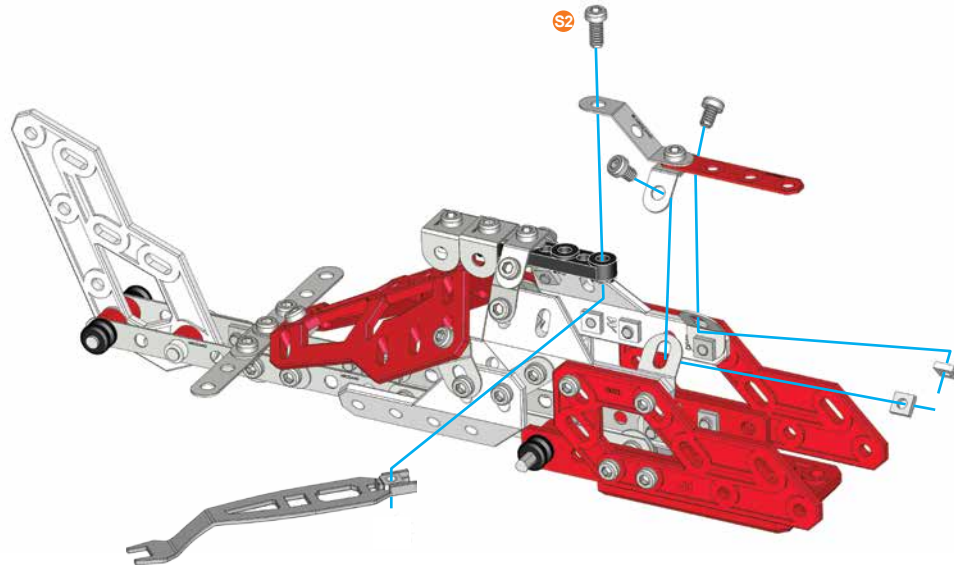
	S1	1:1
	S2	





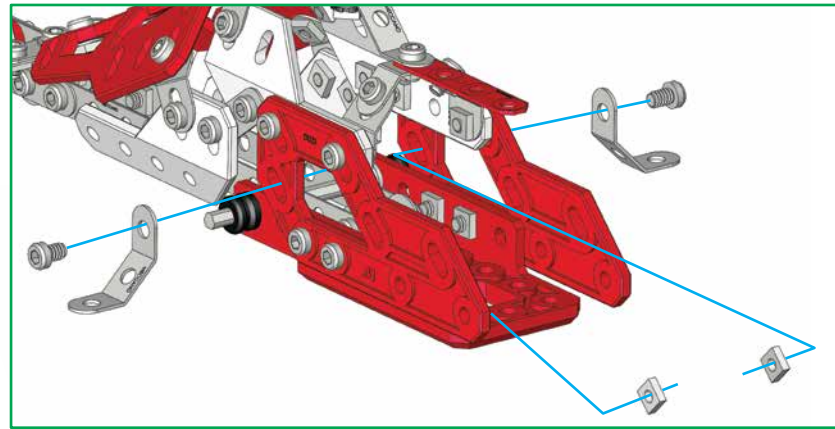
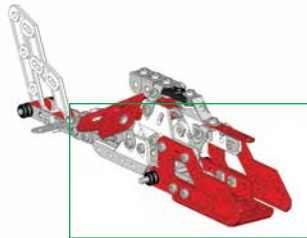

21

	5.8 mm 15/64"	x2
		x2
		x2

	S1	1:1
--	-----------	------------



22

-  **S2** | 9.5 mm | **x3**
-  **x3**
-  **x3**
-  **x1**
-  **x3**





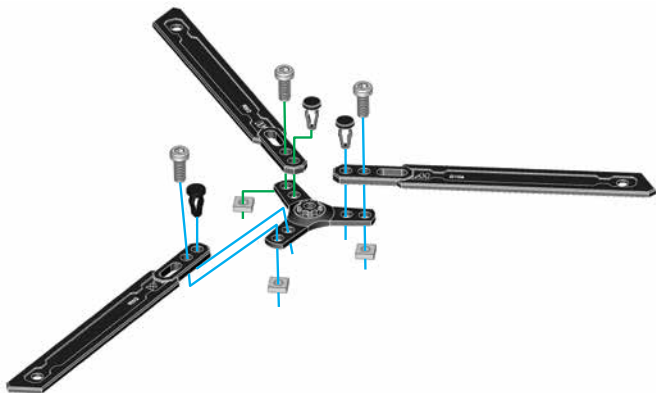

-  **S2** | **1:1**

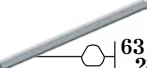

23



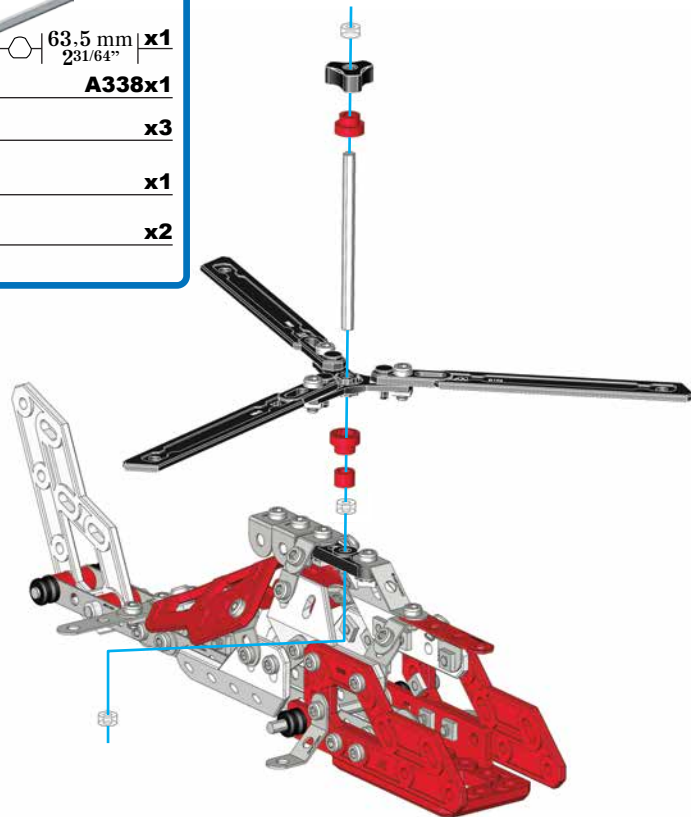

(21)+(22)+

-  | 63.5 mm | **x1**
231/64"
-  **A338x1**
-  **x3**
-  **x1**
-  **x2**



-   **A338**
- 1:1**

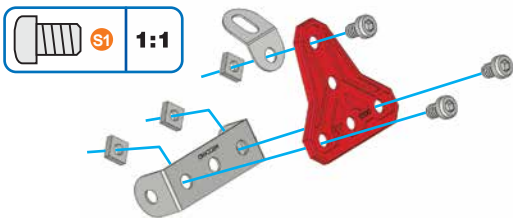

24

	5.8 mm 15/64"	x3		x1
		x3		x1
		x1		



25

23+24+

	5.8 mm 15/64"	x3		x3
		x3		

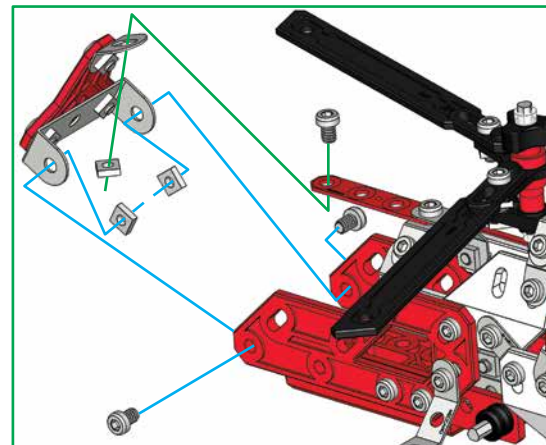
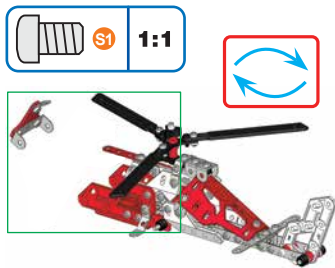



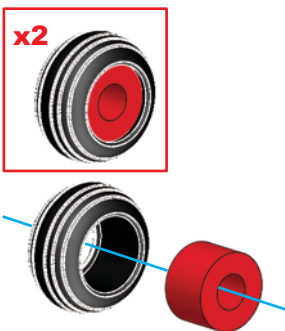

26

	A238x2
	x2



27



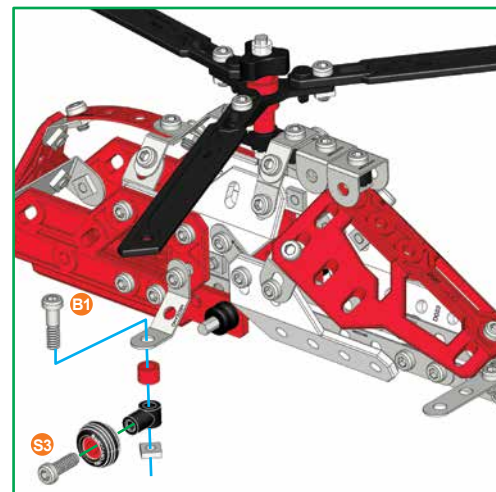
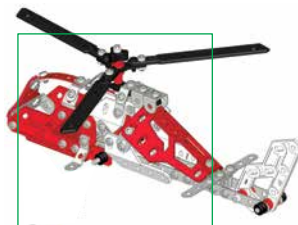
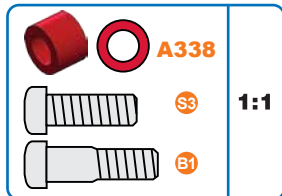

25+26+





	14.7 mm 37/64"	x1
	12 mm 1/2"	x1
		x1
	A338x1	
	x1	



28



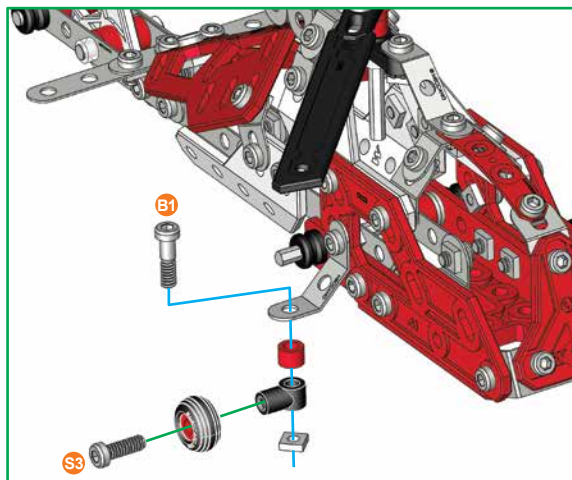
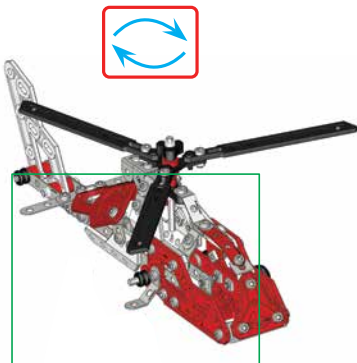

26+27+

-  B1 | 14,7 mm | x1
37/64"
-  S3 | 12 mm | x1
1/2"
-  | x1
-  | **A338**x1
-  | x1

-   **A338**
-  S3 | 1:1
-  B1





29

-  S1 | 5,8 mm | x4
15/64"
-  | x4
-  | x1
-  | x1
-  | x1

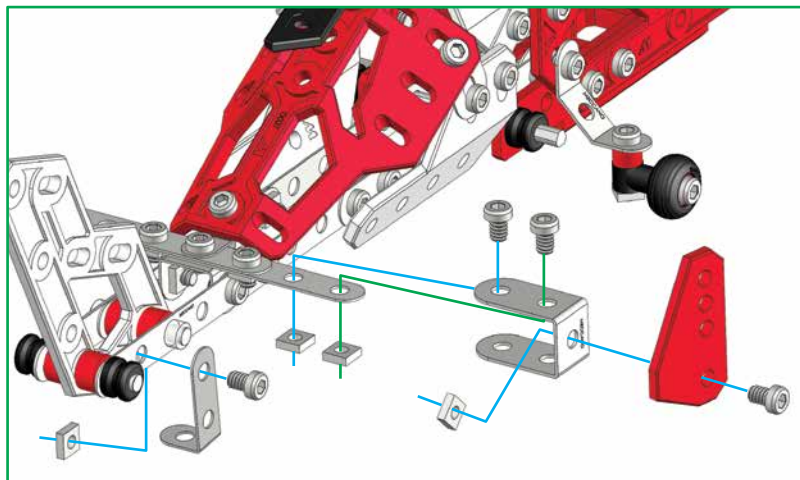
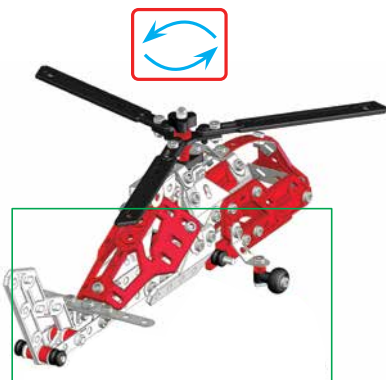
-  S1 | 1:1

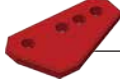

30

	S1 5,8 mm 15/64"	x3
		x3
		x1
		x1

	S1 1:1
---	----------

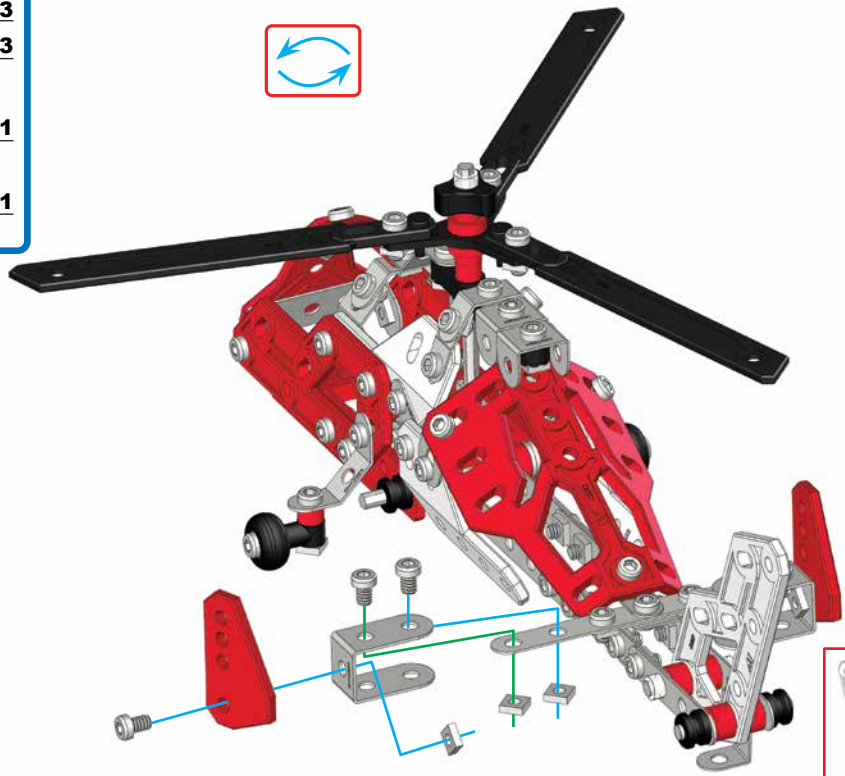
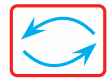



- 1**
- | | | |
|--|------------------|----|
| | 5,8 mm
15/64" | x4 |
| | | x4 |
| | | x1 |
| | | x1 |
| | | x2 |



- | | |
|--|-----|
| | 1:1 |
|--|-----|

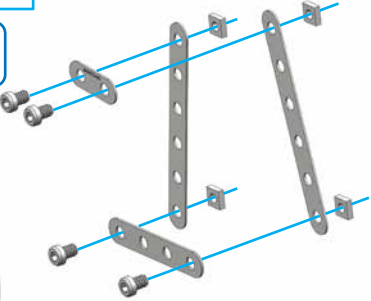

- 2**
- | | | |
|--|------------------|----|
| | 5,8 mm
15/64" | x2 |
| | | x2 |
| | | x4 |

- | | |
|--|-----|
| | 1:1 |
|--|-----|

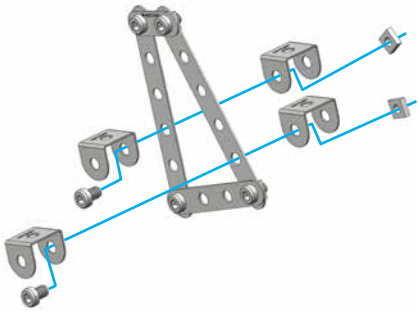

- 3**
- | | | |
|--|----------------|----|
| | 9,5 mm
3/8" | x2 |
| | | x2 |
| | | x1 |
| | | x2 |

- | | |
|--|-----|
| | 1:1 |
|--|-----|

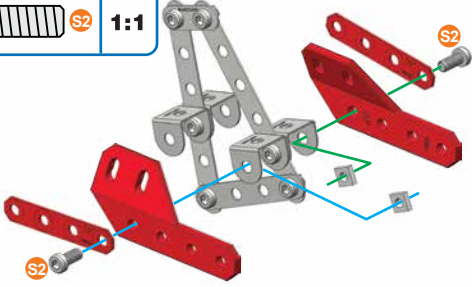

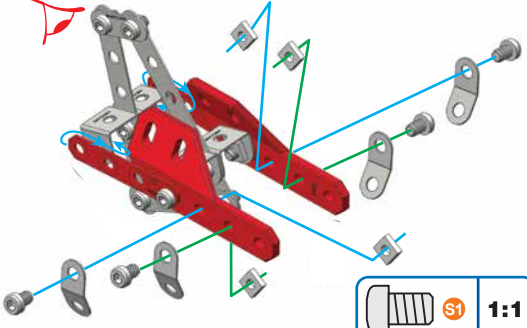

- 4**
- | | | |
|--|------------------|----|
| | 5,8 mm
15/64" | x4 |
| | | x4 |
| | | x4 |





- | | |
|--|-----|
| | 1:1 |
|--|-----|



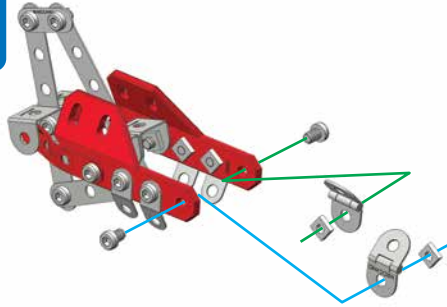

5

	5,8 mm 15/64"	x2
		x2
		x2

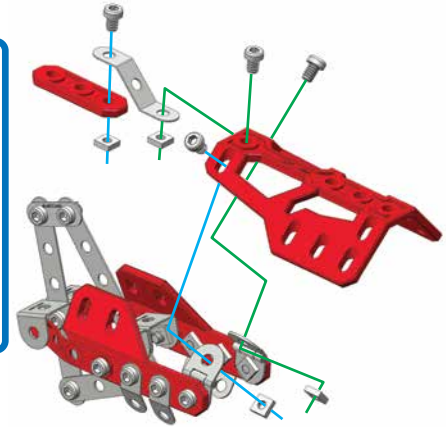



**6**

	5,8 mm 15/64"	x4
		x4
		x1
		x1
		x1

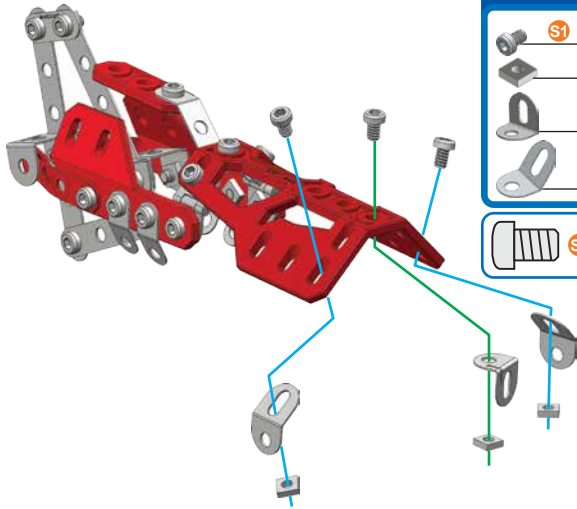
**7**



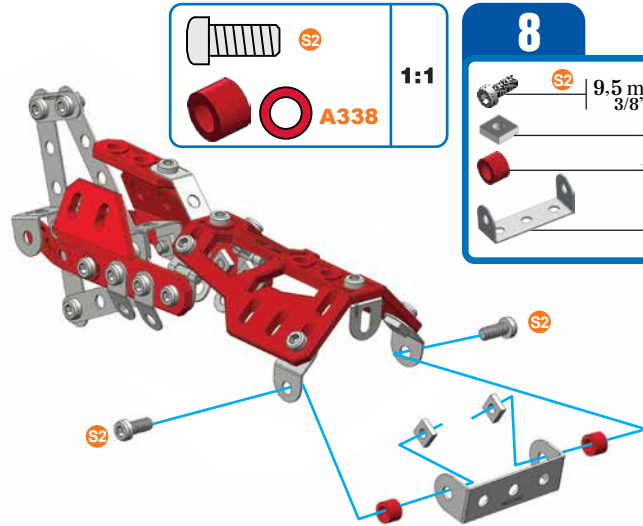

	5,8 mm 15/64"	x3
		x3
		x1
		x2

**8**

	9,5 mm 3/8"	x2
		x2
		A338x2
		x1





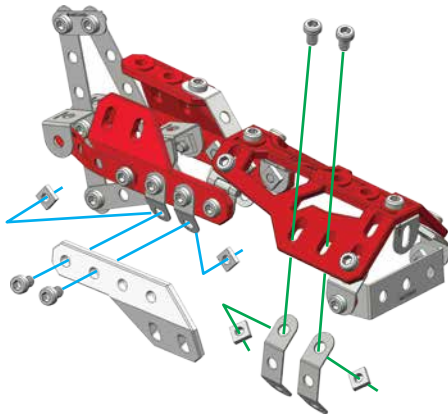

9

 S1	5.8 mm 15/64"	x4
		x4
		x1
		x2







 S1	1:1
--	-----

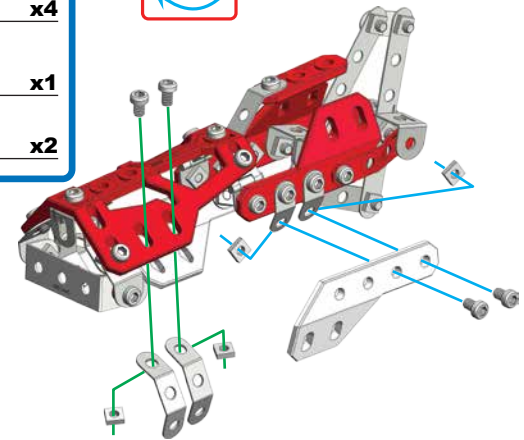



**10**

 S1	5.8 mm 15/64"	x4
		x4
		x1
		x2

 S1	1:1
--	-----

**11**

 S1	5.8 mm 15/64"	x1
 S2	9.5 mm 3/8"	x1
 S3	12 mm 1/2"	x1
		x3
	A338 x1	
		x3
		x1

		A338
	S1	1:1
	S2	
	S3	

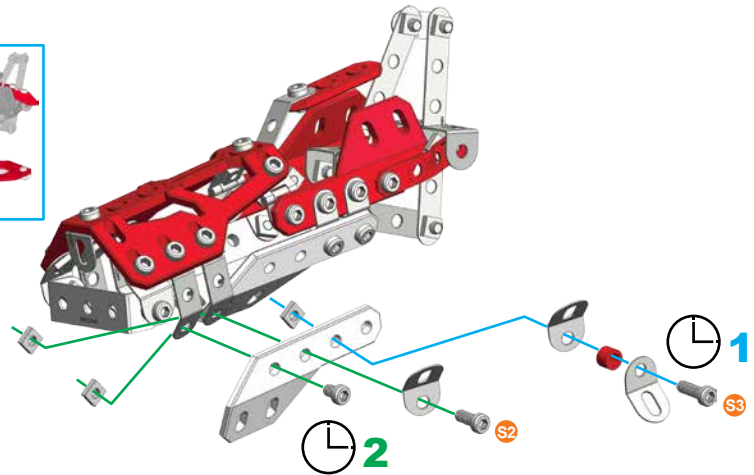
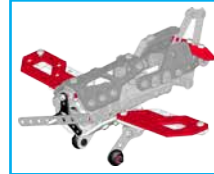

12

	5.8 mm 15/64"	x1
	9.5 mm 3/8"	x1
	12 mm 1/2"	x1
		x3
	A338 x1	
		x3
		x1

	A338	
	S1	1:1
	S2	
	S3	

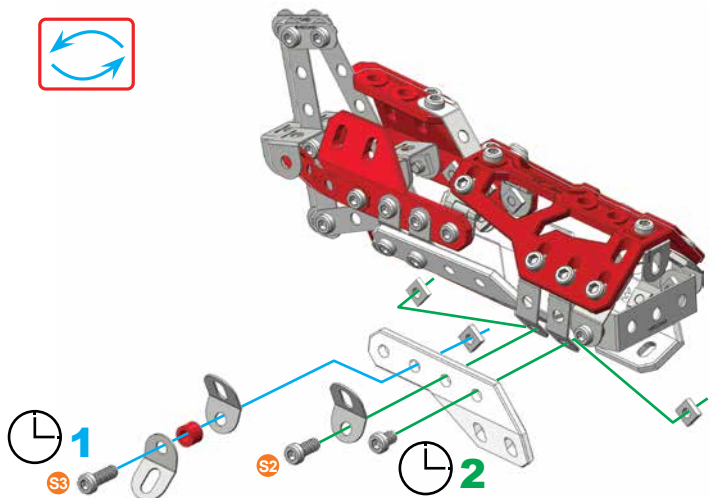



13

	9.5 mm 3/8"	x1
	32 mm 1 1/4"	x1
		x2
		x2
		x2
		x1

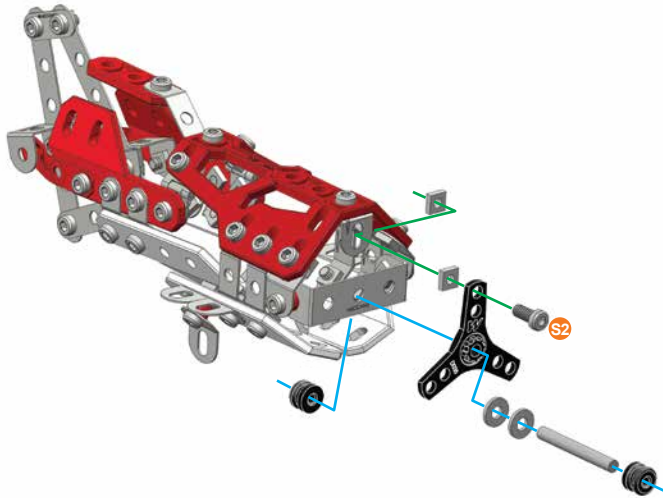
	S2	1:1
--	----	-----



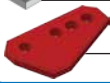

14

 S1	5.8 mm	x2
	15/64"	x2
		x2

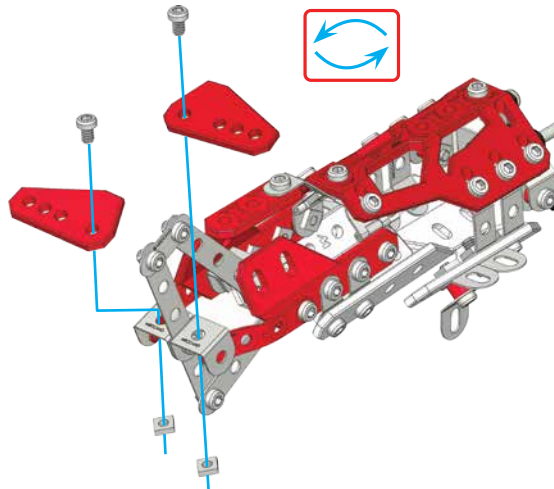
	S1	1:1
---	----	-----





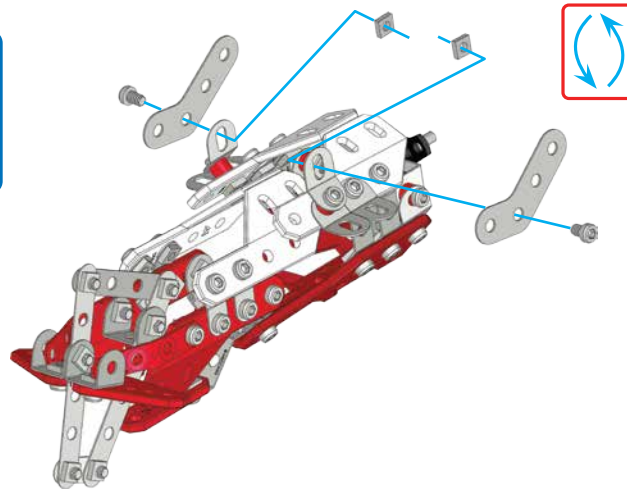

15

 S1	5.8 mm	x2
	15/64"	x2
		x2

	S1	1:1
---	----	-----



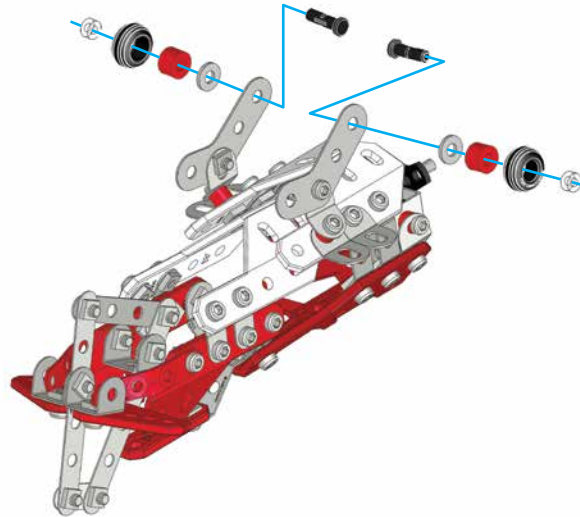

16

	x2
	A238x2
	x2
	x2
	x2







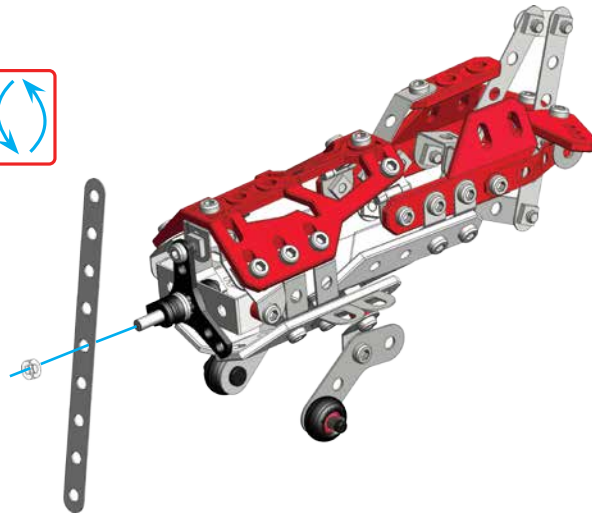



17

	x1
	x1







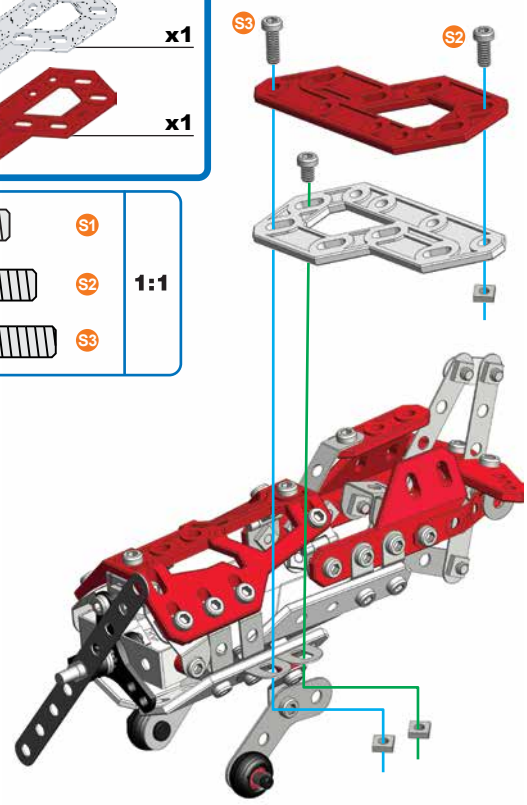

18



	S1	5,8 mm 15/64"	x1
	S2	9,5 mm 3/8"	x1
	S3	12 mm 1/2"	x1
			x3
			x1
			x1

	S1	1:1
	S2	
	S3	









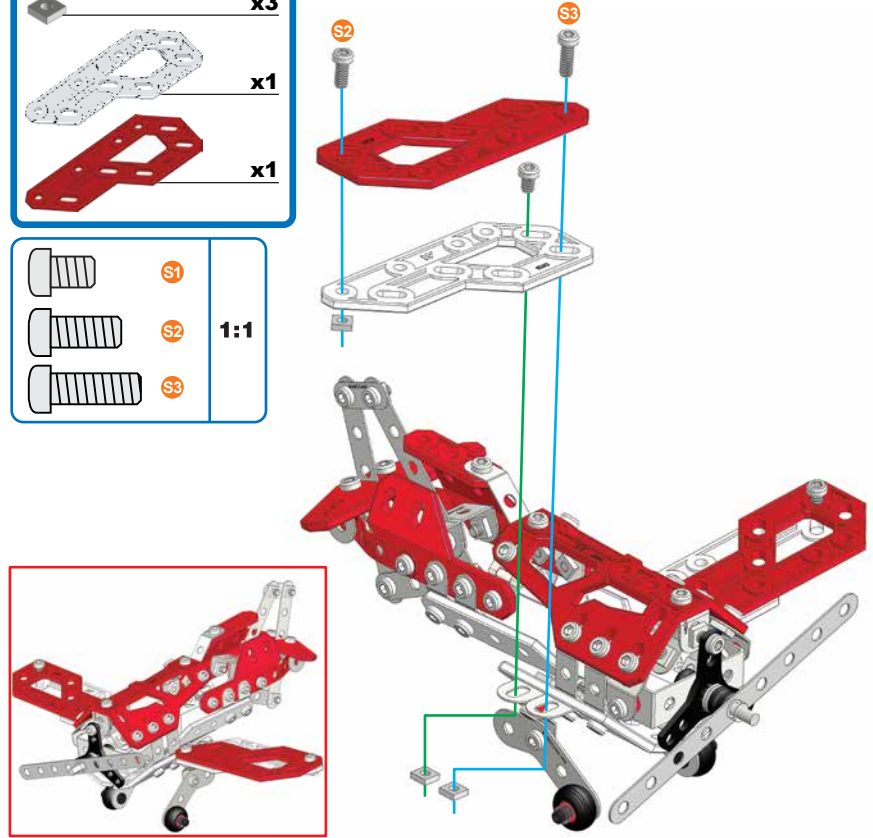



19









	S1	5,8 mm 15/64"	x1
	S2	9,5 mm 3/8"	x1
	S3	12 mm 1/2"	x1
			x3
			x1
			x1













	S1	1:1
	S2	
	S3	





















-  **A337 x93**
-  **A259 x10**
-  **A138 x48**
-  **A338 x16**
-  **A238 x11**
-  **A444 x2**
-  **D105 x4**
-  **A623 x6**
-  **C881 x1**
-  **A326 x1**
-  **D005 x11**
-  **A421 x2**
-  **A313 x1**
-  **C863 x2**
-  **A195 x1**
-  **A242 x4**
-  **A908 x1**
-  **D035 x2**

-  **C483 x4**
-  **C331 x5**
-  **A812 x1**
-  **A825 x1**
-  **A248 x1**
-  **A336 x2**
-  **A012 x1**
-  **A712 x8**
-  **A720 x4**
-  **A721 x4**
-  **A512 x1**
-  **A233 x2**
-  **A174 x1**

-  **D053 x1**
-  **D077 x2**
-  **D090 x1**
-  **D089 x1**
-  **D023 x2**
-  **D023 x2**
-  **D037 x1**
-  **C999 x2**
-  **D106 x6**

-  **C868 x2**
-  **D048 x1**
-  **A420 x2**
-  **D100 x2**
-  **D104 x2**
-  **D049 x1**
-  **D051 x2**
-  **D051 x1**
-  **D052 x2**
-  **D052 x1**
-  **C995 x1**
-  **C993 x1**

-  5.8 mm | **A637 x60**
-  9.5 mm | **A511 x23**
-  12 mm | **A411 x9**
-  14.7 mm | **A247 x3**
-  19 mm | **A447 x2**
-  23 mm | **A347 x1**
-  25 mm | **A018 x1**
-  32 mm | **A518 x2**
-  63.5 mm | **A516 x3**
-  75 mm | **A429 x1**
-  115 mm | **A427 x1**
-  **A806 x3**
-  **C329 x2**
-  **A417 x2**
-  **A235 x2**
-  **A413 x4**
-  **A414 x1**
-  **A415 x1**

EN. Remove all packaging before use. Retain this information, addresses and phone numbers for future reference. Content may vary from pictures. Meccano reserves the right to discontinue the website www.meccano.com at any time. An adult should periodically check this toy to ensure no damage or hazards exist, if so, remove from use. Children should be supervised during play.

FR. Retirer tout l'emballage avant utilisation. Conserver les informations, adresses et numéros de téléphone pour consultation ultérieure. Le contenu peut différer des images. Meccano se réserve le droit de supprimer le site Internet www.meccano.com à tout moment. Un adulte doit régulièrement examiner ce jouet afin de s'assurer qu'il ne présente pas de dommage ni de risque. En cas de problème, ne plus l'utiliser. Les enfants doivent être surveillés lorsqu'ils jouent.

ES. Retire todo el embalaje antes de utilizar el producto. Conserve toda la información, las direcciones y los números de teléfono para futuras referencias. El contenido del paquete puede no corresponder con las imágenes. Meccano se reserva el derecho a suspender el sitio web www.meccano.com en cualquier momento. Un adulto debe revisar de forma periódica el juguete para asegurarse de que no supone un riesgo o peligro para el niño; si así fuera el caso, interrumpa su uso. Supervise a los niños mientras juegan con el producto.

DE. Entfernen Sie vor der Benutzung sämtliche Verpackungsmaterialien. Alle Informationen, Adressen und Telefonnummern bitte für mögliche Rückfragen aufbewahren. Der Packungsinhalt kann von den Bildern abweichen. Meccano behält sich das Recht vor, den Betrieb der Website www.meccano.com jederzeit einzustellen. Ein Erwachsener sollte regelmäßig sicherstellen, dass das Spielzeug keine Gefahr darstellt, und es gegebenenfalls entfernen. Kinder sollten beim Spielen beaufsichtigt werden.

NL. Verwijder de verpakking voor gebruik. Bewaar deze informatie, adressen en telefoonnummers voor toekomstig gebruik. Inhoud kan afwijken van illustraties. Meccano behoudt zich het recht voor de website www.meccano.com wanneer gewenst buiten gebruik te stellen. Een volwassene dient dit speelgoed regelmatig te controleren. In geval van schade of gevaar het speelgoed niet meer gebruiken. Houd toezicht als kinderen spelen.

IT. Rimuovere l'imballo prima dell'uso. Conservare informazioni, indirizzi e numeri di telefono per riferimento futuro. Il prodotto potrebbe essere differente dalle immagini. Meccano si riserva il diritto di rimuovere il sito www.meccano.com in qualsiasi momento. Il giocattolo deve essere periodicamente controllato da un adulto per prevenire eventuali danni o rischi; in caso di danno, sospendere l'uso. I bambini devono essere sorvegliati durante il gioco.

PT. Remova totalmente a embalagem antes de utilizar. Guarde todos os endereços, números de telefone e demais informações para consulta e referência. O conteúdo poderá ser diferente das ilustrações. A Meccano reserva-se o direito de descontinuar o site www.meccano.com a qualquer altura. Um adulto deve verificar o brinquedo periodicamente para garantir que não há danos ou riscos. Se houver, é necessário que o brinquedo seja retirado de uso. Crianças devem ser supervisionadas enquanto brincam.

RU. Снимите все упаковочные материалы перед использованием. Запишите указанные на упаковке адреса и номера телефонов, чтобы у вас была возможность связаться с нами. Содержимое упаковки может отличаться от иллюстрации. Компания Meccano оставляет за собой право прекратить использование сайта www.meccano.com в любое время. Взрослым следует время от времени проверять игру и следить за тем, чтобы она не была сломана и не представляла опасности для ребенка. В противном случае ее не следует использовать. Во время игры дети должны находиться под присмотром взрослых.

- △ Warning: Strangulation hazard - Long cord; CHOKING HAZARD - Small parts.
- △ Attention ! Risque de strangulation - Long cordon ; RISQUE D'ETOUFFEMENT - Contient de petits éléments.
- △ Advertencia: Peligro de estrangulamiento - Cordón largo; PELIGRO DE ASFIXIA - Contiene piezas pequeñas No conveniente para niños menores de 3 años.
- △ Achtung: Strangulierungsgefahr- Lange Kordel; ERSTICKUNGSGEFAHR - Kleinteile.
- △ Waarschuwing: Kans op wurging. Lang snoer; VERSTIKKINGSGEVAAR - Kleine onderdelen.
- △ Attenzione: Rischio di strangolamento - Cavo lungo; RISCHIO DI SOFFOCAMENTO - Pezzi piccoli.
- △ Aviso: Risco de estrangulamento. Fio longo; PERIGO DE ASFIXIA - Peças pequenas.
- △ Осторожно! Опасность удушья. Длинный шнур; ОПАСНОСТЬ ДУДУШЬЯ - Мелкие детали.



NORTH AMERICA - 1-800-622-8339, customercare@spinmaster.com
UK - 0800 206 1191, serviceuk@spinmaster.com
IRELAND - 1800 992 249
FRANCE - 0800 909 150, servicefr@spinmaster.com
DEUTSCHLAND - 0800 0101 0222, Kundenservice@spinmaster.com
SCHWEIZ - 0800 561 350 • ÖSTERREICH - 0800 297 267
NEDERLAND - 0800 022 3683, klantenservice@spinmaster.com
BELGIË/BELGIQUE - 0800 77 688 • LUXEMBOURG - 800 2 8044
ITALIA - 800 788 532, servizio@spinmaster.com
MEXICO - 55 4160 7947, servicio@spinmaster.com

WWW.SPINMASTER.COM

SPIN MASTER LTD., 450 FRONT STREET WEST, TORONTO, ON M5V 1B6 CANADA.
DISTRIBUTED IN EU BY SPIN MASTER INTERNATIONAL, S.A.R.L.,
16 AVENUE PASTEUR, L-2310, Luxembourg. www.spinmaster.com
Made in France by / Fabriqué en France par / Hecho en Francia por
Meccano: 363, avenue de Saint-Exupéry 62100 Calais - France



TM & © 2016 MECCANO for packaging, instructions and models built with this set. / TM & © 2016 MECCANO pour l'emballage, les notices et modèles de ce coffret. / MECCANO® is an exclusive trademark of MECCANO. Spin Master logo is a trademark of Spin Master Ltd. / MECCANO® est une marque de commerce exclusive de MECCANO. Le logo de Spin Master est une marque de commerce de Spin Master Ltd. / All rights reserved. / Tous droits réservés.

T91775_0006_20074305_GML_IB_R1R1_MEC_Helicopter_FR_F16