

MECCANOTM
M A K E R S Y S T E M

**AUTOCROSS RC
BUGGY DE COURSE RC**

**REMOTE CONTROL
RADIOCOMMANDÉ**

14303



27.145 MHz

REMOTE CONTROL
RADIOCOMMANDÉ
CONTROL REMOTO

 **10+**

Instructions
Notice de montage
Instrucciones de construcción
Bauanleitung

Bouwinstructie
Istruzioni
Instruções
Инструкции





CONSTRUCTION TIPS ASTUCES DE CONSTRUCTION

TIPS DE CONSTRUCCIÓN
TIPPS ZUM BAUEN
MONTAGETIPS
SUGGERIMENTI PER COSTRUIRE
DICAS DE MONTAGEM
РЕКОМЕНДАЦИИ ПО СБОРКЕ

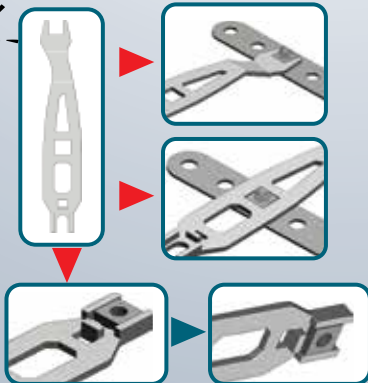
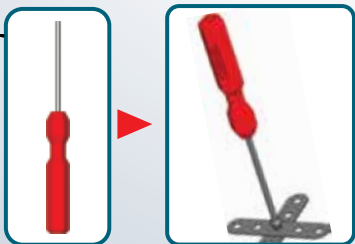

NEW TOOLS/NOUVEAUX OUTILS
NUEVAS HERRAMIENTAS/NEUE WERKZEUGE/NIUW GEREEDSCHAP
NUOVI ATTREZZI/NOVAS FERRAMENTAS/

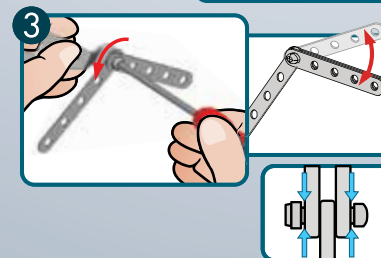
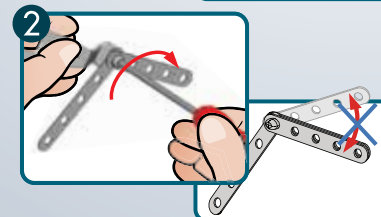
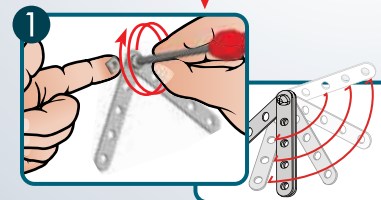
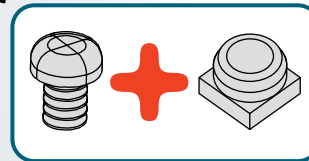
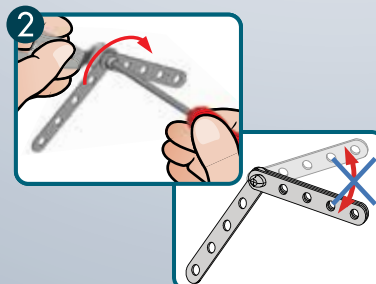
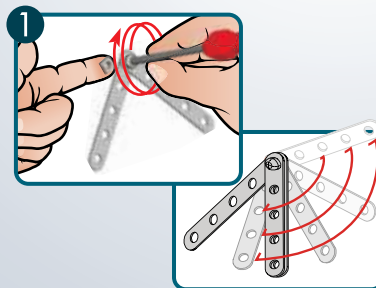
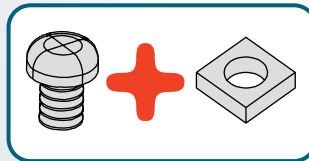



GB USA Refer to the **USER GUIDE**, included in the box, for safety information, operating the remote control and legal information.

F Se reporter au **GUIDE DE L'UTILISATEUR** inclus dans la boîte pour toute information légale, sur la sécurité ou sur le fonctionnement de la radiocommande.

E Consulte la **GUÍA DEL USUARIO** incluida en la caja para ver información sobre seguridad, el funcionamiento del control remoto e información legal.

D Die im Lieferumfang enthaltene **BEDIENUNGSANLEITUNG** umfasst Sicherheitshinweise, Anleitungen zur Bedienung der Fernsteuerung und rechtliche Informationen.

NL Raadpleeg de **GEBRUIKSAANWIJZING** die is meegeleverd in de doos voor informatie over veiligheid, gebruik van de afstandsbediening en juridische informatie.

I Consultare la **GUIDA PER L'USO**, inclusa nella confezione, per informazioni sulla sicurezza, istruzioni sull'uso del radiocomando e informazioni legali.

P Consulte o **MANUAL DO UTILIZADOR**, incluído na caixa, para obter informações sobre segurança, o funcionamento do controlo remoto e informação legal.

R Ознакомьтесь с **РУКОВОДСТВОМ ПО ИСПОЛЬЗОВАНИЮ**, находящимся в коробке. Оно содержит сведения о технике безопасности и работе устройства дистанционного управления, а также правовую информацию.

CONSTRUCTION TIPS ASTUCES DE CONSTRUCCIÓN

TIPS DE CONSTRUCCIÓN
TIPPS ZUM BAUEN
MONTAGETIPS
SUGGERIMENTI PER COSTRUIRE
DICAS DE MONTAGEM
РЕКОМЕНДАЦИИ ПО СБОРКЕ

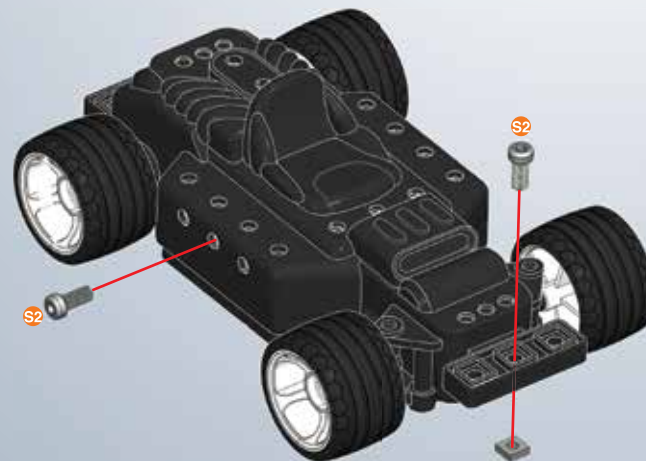

TABLE OF CONTENTS/SOMMAIRE

ÍNDICE / INHALTSVERZEICHNIS / INHOUD / INDICE / ÍNDICE / СОДЕРЖАНИЕ

AVAILABLE ONLINE / DISPONIBLE EN LIGNE
DISPONIBLES EN LÍNEA / ONLINE VERFÜGBAR /
ONLINE BESCHIKBAAR / DISPONIBILI ONLINE /
DISPONÍVEL ONLINE / ДОСТУПНЫ В ОНЛАЙН-МАГАЗИНЕ



GB. Content: 130 parts, 2 real tools, 1 remote controller, 1 RC Chassis, 1 Sticker sheet and 1 instruction sheet for model#1.
F. Contenu : 130 pièces, 2 vrais outils, 1 radiocommande, 1 chassis R/C, 1 feuillet d'autocollants et 1 notice de montage pour le modèle 1.
E. Contenido: 130 piezas, 2 herramientas reales, 1 control remoto, 1 chasis RC, 1 hoja de calcomanías y 1 guía de instrucciones para el modelo 1.
D. Inhalt: 130 Teile, 2 echte Werkzeuge, 1 Fernsteuerung, 1 Fahrgestell mit ferngesteuertem Antrieb, 1 Bogen mit Aufklebern und 1 Bauanleitung für Modell Nr. 1.
NL. Inhoud: 130 onderdelen, 2 stuks gereedschap, 1 afstandsbediening, 1 RC-chassis, 1 stickervel en 1 bouw instructie voor model 1.
I. Contenuto: 130 pezzi, 2 attrezzi, 1 radiocomando, 1 telaio radiocomandato, 1 foglio di adesivi e 1 guida per l'uso per il modello 1.
P. Conteúdo: 130 peças, 2 ferramentas reais, 1 controle remoto, 1 chassis RC, 1 cartela de adesivos e 1 folha de instruções para o modelo 1.
R. В коробке: 130 деталь, 2 настоящих инструмента, 1 устройство дистанционного управления, 1 радиоуправляемое шасси, 1 лист с наклейками и 1 инструкция по сборке модели №1.

GB. Only one model can be built at a time. **F.** Les pièces fournies ne permettent de monter qu'un seul modèle à la fois. **E.** Solo es posible construir un modelo a la vez. **D.** Jeweils nur eins der Modelle baubar. **NL.** Er kan maar een model tegelijk worden gebouwd. **I.** Permette di realizzare un solo modello per volta. **P.** Só é possível montar um modelo de cada vez. **R.** Одновременно можно построить только одну модель.



GB. Building instructions for model#2 are available at www.meccano.com.
F. La notice de montage du modèle 2 est disponible sur www.meccano.com.
E. Hay instrucciones de construcción disponibles para el modelo 2 en www.meccano.com.
D. Die Bauanleitung für Modell Nr. 2 ist auf www.meccano.com zu finden.
NL. Bouwinstructies voor model#2 zijn beschikbaar op www.meccano.com.
I. Le istruzioni di montaggio del modello 2 sono disponibili alla pagina www.meccano.com.
P. As instruções de montagem para o modelo 2 estão disponíveis em www.meccano.com.
R. Инструкции по сборке модели №2 можно найти на сайте www.meccano.com.



1

	x1
	x2
	x2
	x2

	1:1
--	------------

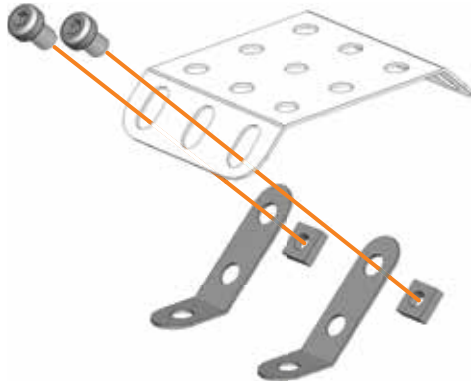

2

	x4
	x4
	x4
	x4

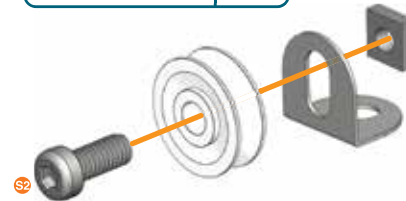

	1:1
--	------------



x4





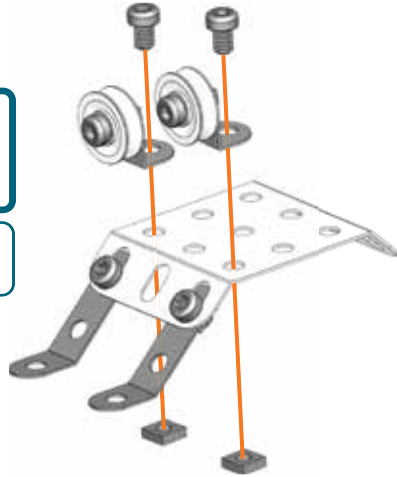

3 ① + ② +

 S1	5,8 mm 15/64"	x2
		x2

	S1	1:1
---	----	-----







4

		x1
		x1
 S1	5,8 mm 15/64"	x1
		x1

	S1	1:1
---	----	-----





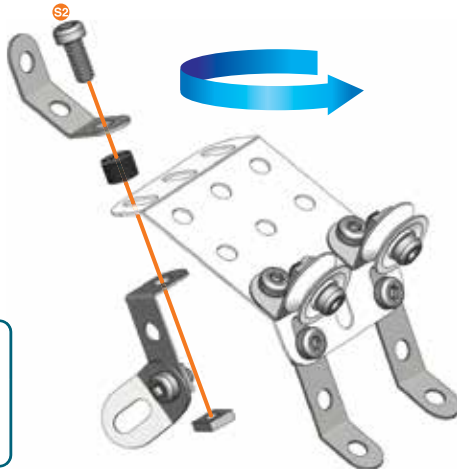

5 ③ + ④ +

		x1
		x1
 S2	9,5 mm 3/8"	x1
		x1

		A338	1:1
	S3		



6

		x1
		x1
 S1	5,8 mm 15/64"	x1
		x1

	S1	1:1
--	----	-----

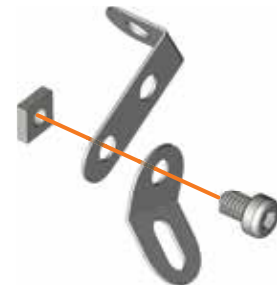



7 (5) + (6) +

	x1
	x1
	x1
	x1

		1:1

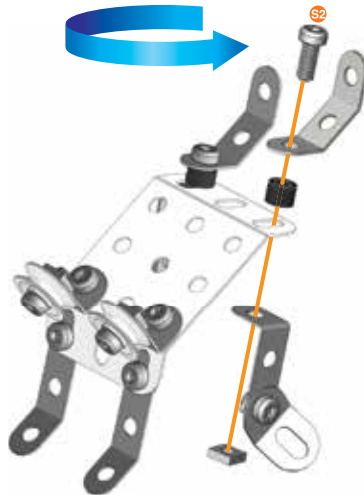

8

	x1
	x1
	x1

	S1	1:1
--	----	-----

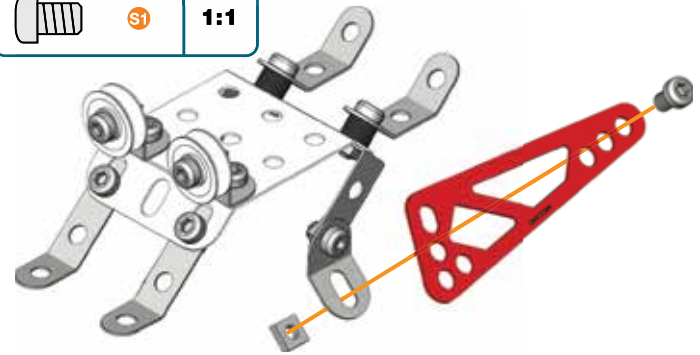



9

	x1
	x1
	x1

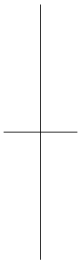
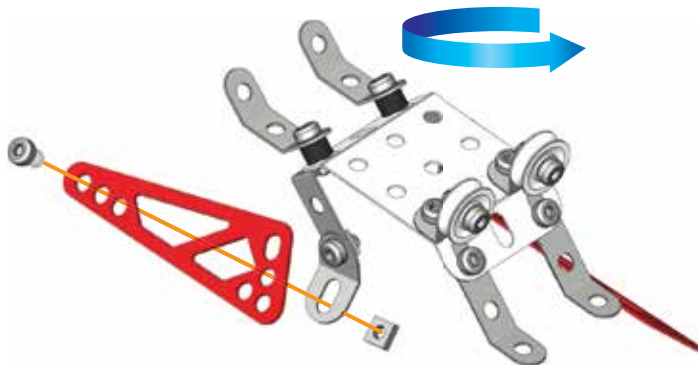

	S1	1:1
--	----	-----

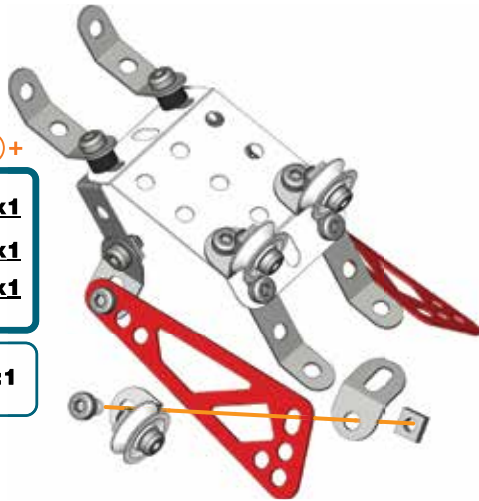

- 10** ② + ⑨ +
-  **x1**
 -  5,8 mm 15/64" **x1**
 -  **x1**

-  **S1** **1:1**



- 11** ② + ⑩ +
-  **x1**
 -  5,8 mm 15/64" **x1**
 -  **x1**

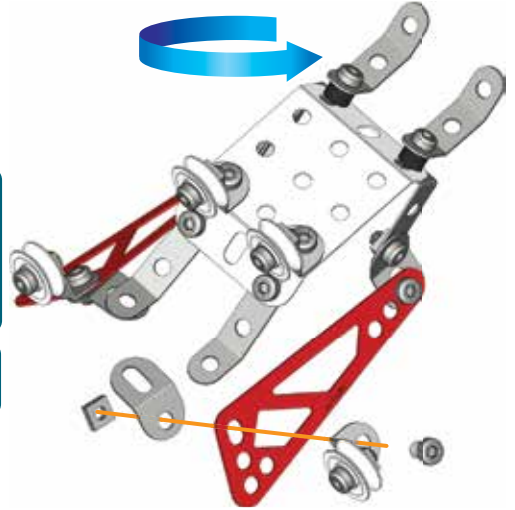

-  **S1** **1:1**

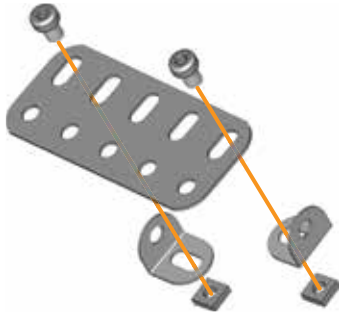

- 12**
-  **x1**
 -  **x2**
 -  5,8 mm 15/64" **x2**
 -  **x2**

-  **S1** **1:1**



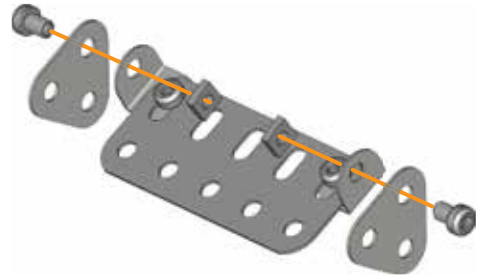

- 13**
-  **x2**
 -  5,8 mm 15/64" **x2**
 -  **x2**

-  **S1** **1:1**



14





11 + 13 +

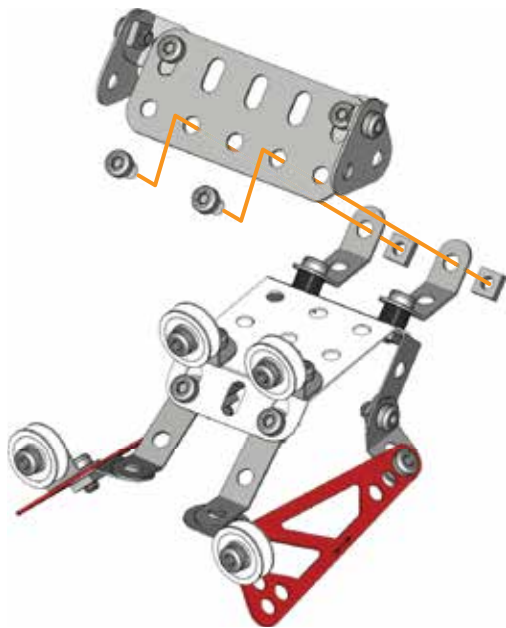

-  5,8 mm | **x2**
15/64"
-  **x2**

-  **S1** | **1:1**



15

-  **x1**
-  **x1**
-  **x2**
-  12 mm | **x2**
1/2"

-   **A238** | **1:1**
-  **S3**

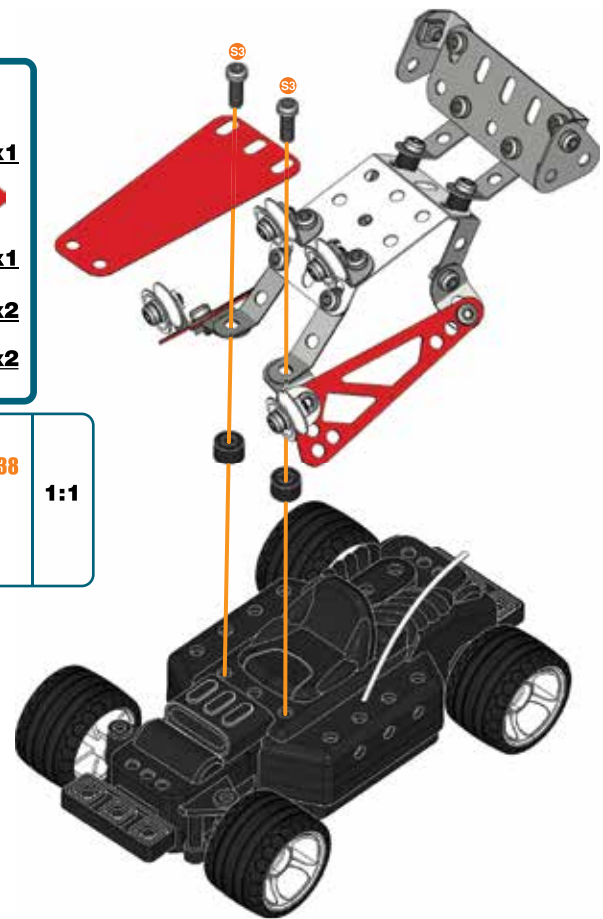

16

	x1
	x1
	x2 5,8 mm 15/64"
	x2

	S1	1:1
--	-----------	------------

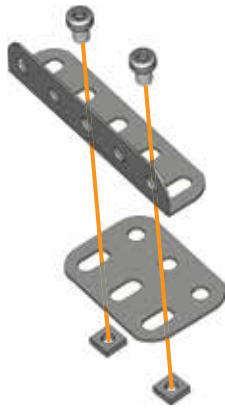

17

	x1
	x1
	x1 5,8 mm 15/64"
	x1

	S1	1:1
--	-----------	------------

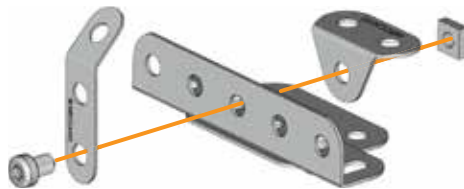



18 (15+)(17+)

	x2
	x2 14,7 mm 37/64"
	x2

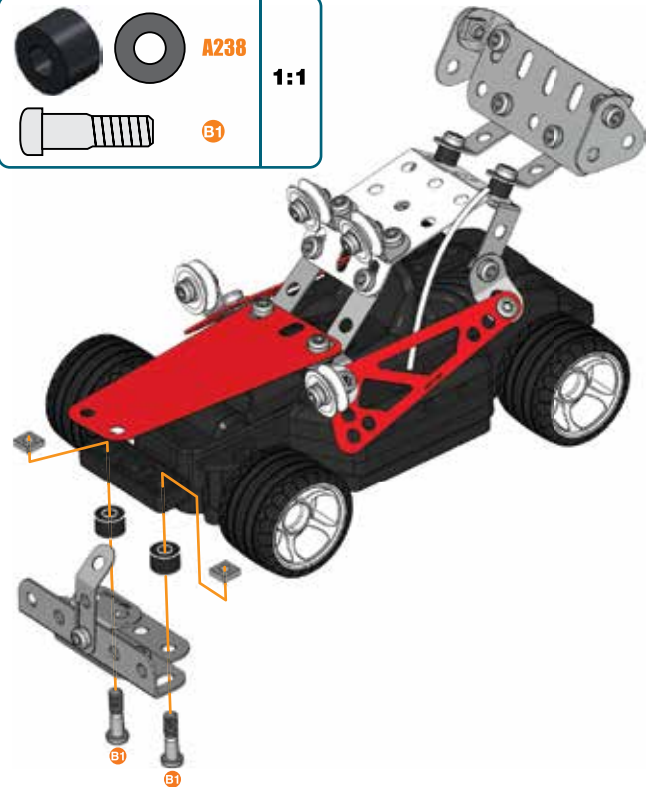
		A238	1:1
		B1	





19

	5,8 mm 15/64"	x2
		x2

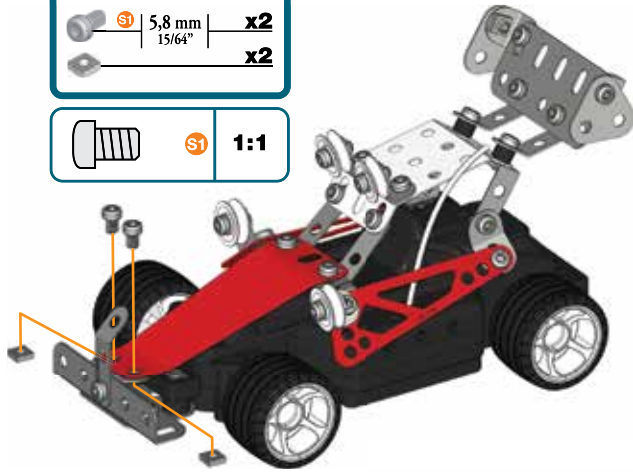

	1:1
---	------------

**20**

	x2	
	5,8 mm 15/64"	x2
		x2

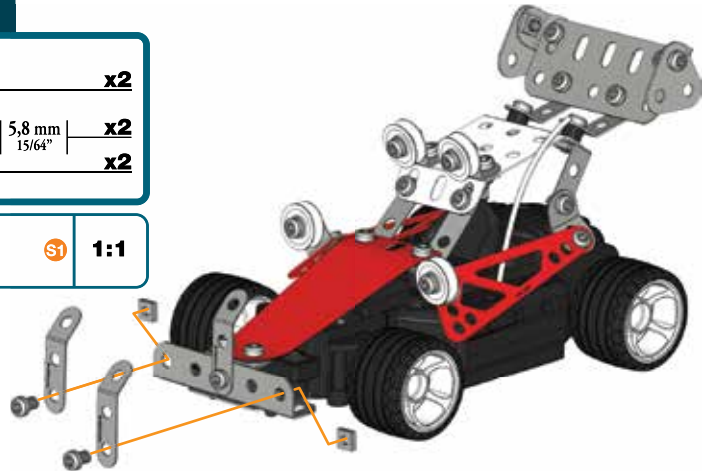
	1:1
---	------------



**21**

	x1	
	5,8 mm 15/64"	x3
		x3

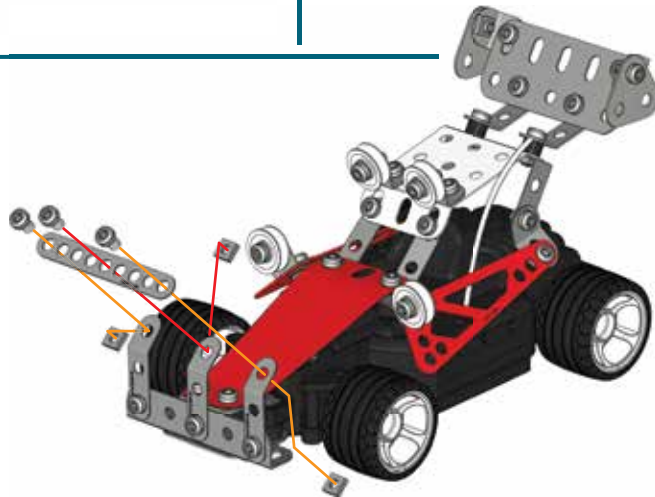
	1:1
---	------------





22

-  **x3**
-  9,5 mm | **x3**
3/8"
-  **x3**

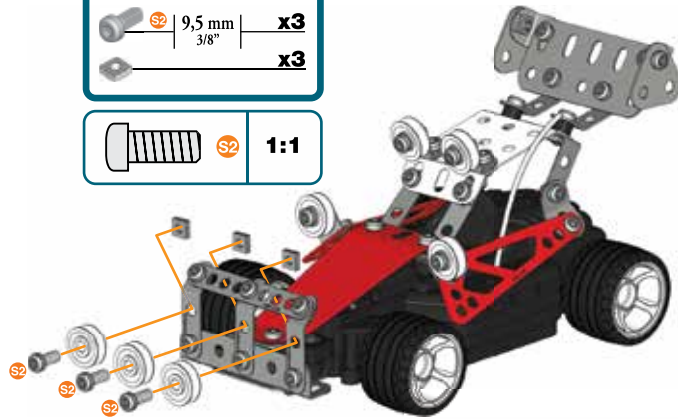

-  **1:1**

**23**

-  **x1**
-  **x2**
-  12 mm | **x2**
1/2"

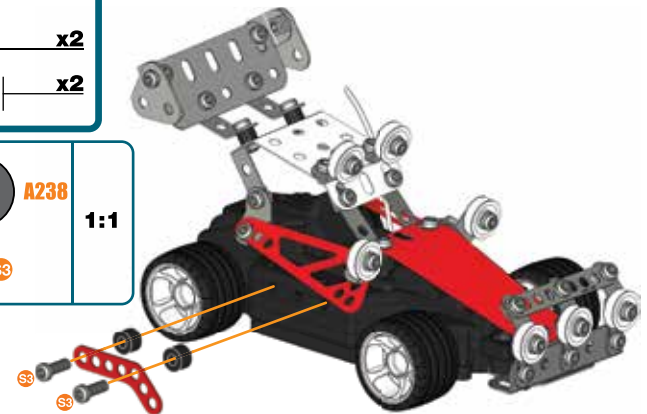
-   **A238**
-  **1:1**

**24**

-  **x1**
-  **x2**
-  12 mm | **x2**
1/2"

-   **A238**
-  **1:1**

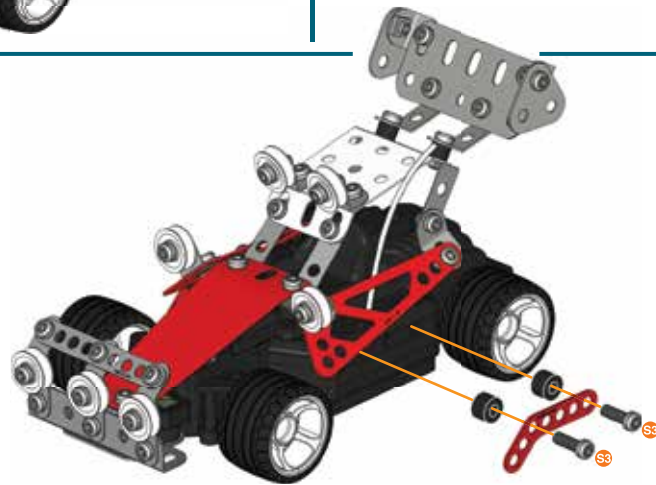



C531 x1



B582 x1



C472 x2



C771 x1



A602 (0009D) x1



A300 (0103F) x1



A307 (0103H) x1



C775 x2



C508 x1



A851 (00516) x1



A277 (0077) x2



C860 x1



A437 (0812D) x5



A812 (0812B) x2



C331 x2



A712 (0012C) x4



A012 (0012) x6



A524 (0023BP) x7



B1

14,7 mm
37/64"

A247 (0147D) x2



S3

12 mm
1/2"

A411 (0111A) x6



S2

9,5 mm
3/8"

A511 (0111C) x9



S1

5,8 mm
15/64"

A637 (0037B) x26



A337 (0037A) x37



A238 (0038A) x8



A338 (0038B) x2



C994 x1



C993 x1



GB/USA Requires 3xAA(LR6) and 1x 9V (PP3) batteries (not included). Batteries or battery packs must be recycled or disposed of properly. When this product has reached the end of its useful life it should not be disposed of with other household waste. The Waste Electrical and Electronic Equipment Regulations require it to be separately collected so that it can be treated using the best available recovery and recycling techniques. This will minimize the impact on the environment and human health from soil and water contamination by any hazardous substances, decrease the resources required to make new products and avoid using up landfill space. Please do your part by keeping this product out of the municipal waste stream! The “wheelie bin” symbol means that it should be collected as “waste electrical and electronic equipment”. You can return an old product to your retailer when you buy a similar new one. For other options, please contact your local council.

F Fonctionne avec 3 piles AA (LR6) et 1 pile 9 V (PP3) (non fournies). Les piles ou les batteries doivent être correctement recyclées ou éliminées. Lorsque ce produit arrive en fin de vie, il ne doit pas être jeté avec le reste des déchets ménagers. Conformément à la directive sur les Déchets des équipements électriques et électroniques (DEEE), il doit être collecté séparément afin d'être éliminé selon les meilleures techniques de récupération et de recyclage disponibles. Cette démarche réduit les risques de pollution du sol et des eaux, et permet ainsi de minimiser l'impact de toute substance nocive sur la santé et sur l'environnement. Cela diminue également la quantité de ressources nécessaires à la fabrication de nouveaux produits, et évite la saturation des sites d'enfouissement. Veuillez apporter votre contribution en ne jetant pas ce produit avec les déchets de votre commune. Le symbole de la « poubelle sur roues » signifie que ce produit doit faire l'objet d'une collecte respectant la directive sur les Déchets des équipements électriques et électroniques (DEEE). Vous pouvez également retourner les produits en fin de vie à votre détaillant lors de l'achat d'un produit similaire neuf. Pour plus d'informations, contactez votre commune.

E Funciona con 3 pilas AA (LR6) y 1 pila alcalina de 9 V (PP3) (no incluidas). Las pilas o las baterías deben ser recicladas o desechadas de manera apropiada. Cuando este producto alcance el final de su vida útil, no lo deseches como residuo doméstico. La normativa exige que se recoja de forma separada para que pueda tratarse con las mejores técnicas de recuperación y reciclaje disponibles. De esta forma, se minimizará el impacto que la contaminación del suelo y el agua causada por sustancias peligrosas tiene sobre el medio ambiente y la salud humana, se reducirán los recursos necesarios para fabricar nuevos productos y se evitará la saturación de los vertederos. ¡Colabora desechando este producto de forma adecuada! El símbolo del contenedor con ruedas significa que debería recogerse como residuo de aparatos eléctricos y electrónicos. Puedes devolver un producto antiguo en tu establecimiento habitual cuando adquieras un producto nuevo similar. Si deseas obtener más información, consulta con las autoridades locales.

D Benötigt 3 Alkali-Mignonzellen (AA/LR6) und 1 9-V-Batterie (PP3) (nicht enthalten). Batterien oder Akkus müssen recycelt oder ordnungsgemäß entsorgt werden. Ist das Gerät nicht mehr zu gebrauchen, darf es nicht über den Hausmüll entsorgt werden. Die Elektroaltgeräteverordnung (EAG-VO) sieht vor, dass das Gerät separat entsorgt wird, damit es so weit wie möglich recycelt werden kann. Dadurch lassen sich die Menge an umwelt- und gesundheitsschädlichen Substanzen, die über den Boden und das Grundwasser in den menschlichen Nahrungskreislauf gelangen könnten, minimieren, die für die Herstellung neuer Produkte erforderlichen Ressourcen reduzieren und Platz auf Mülldeponien sparen. Leisten Sie bitte Ihren Beitrag dazu, indem Sie das Gerät nicht über den Hausmüll entsorgen. Das Mülltonnen-Symbol bedeutet, dass das Gerät gemäß den Vorschriften für Elektro- und Elektronikgeräte entsorgt werden muss. Alte Geräte können oft beim Kauf eines neuen, ähnlichen Geräts im Einzelhandel zurückgegeben werden. Weitere Entsorgungsmöglichkeiten erfragen Sie bitte bei Ihrer Gemeindeverwaltung.

NL Vereist 3x AA (LR6) en 1x 9V (PP3) alkalinebatterijen (niet inbegrepen). Batterijen en accu's dienen op de juiste wijze te worden gerecycled of afgevoerd. Wanneer dit product het einde van zijn levensduur heeft bereikt, mag het niet samen met ander huishoudelijk afval worden weggegooid. Volgens de wet moet het afzonderlijk worden ingezameld zodat het kan worden behandeld met de best beschikbare recycletechnieken. Op deze manier wordt de invloed op het milieu en de menselijke gezondheid van grond- en watervervuiling door gevaarlijke stoffen geminimaliseerd, hoeven er minder bronnen te worden gebruikt om nieuwe producten te maken en raken stortplaatsen minder snel vol. Draag je steentje bij door dit product uit de gemeentelijke afvalstroom te houden! Het afvalcontainersymbool betekent dat het product moet worden ingezameld als elektrische en elektronische afvalapparatuur. Je kunt een oud product inruilen bij de detailhandelaar wanneer je een vergelijkbaar nieuw product koopt. Neem voor andere opties contact op met de gemeente.

I Richiede 3 pile AA (LR6) e 1 pila 9V (PP3) (non incluse). Le batterie e le loro confezioni devono essere riciclate o smaltite correttamente. Il simbolo del cassonetto barrato riportato sull'apparecchiatura indica che il prodotto alla fine della propria vita utile deve essere raccolto separatamente dagli altri rifiuti. L'utente dovrà, pertanto, conferire l'apparecchiatura integra dei componenti essenziali giunta a fine vita agli idonei centri di raccolta differenziata dei rifiuti elettronici ed elettrotecnici, oppure riconsegnarla al rivenditore al momento dell'acquisto di una nuova apparecchiatura di tipo equivalente, in ragione di uno a uno. L'adeguata raccolta differenziata per l'avvio successivo dell'apparecchiatura dimessa al riciclaggio, al trattamento e allo smaltimento ambientale compatibile contribuisce ad evitare possibili effetti negativi sull'ambiente e sulla salute e favorisce il riciclo dei materiali di cui è composta l'apparecchiatura. Lo smaltimento abusivo del prodotto da parte dell'utente comporta l'applicazione delle sanzioni amministrative di cui al D.Lgs n.152/2006 (parte 4 art.255).

P São necessárias pilhas alcalinas, 3x AA (LR6) e 1x 9V (PP3) (não incluídas). As pilhas ou baterias deverão ser recicladas ou eliminadas de forma adequada. Quando este produto alcançar o fim da sua vida útil não deverá ser eliminado junto dos resíduos domésticos. Por lei, deverá ser recolhido em separado para posterior tratamento usando as melhores técnicas de recuperação e reciclagem disponíveis. Desta forma, minimiza-se o impacto no ambiente e saúde humana da contaminação do solo e água por substâncias perigosas, diminui-se os recursos necessários para fabricar novos produtos e evita-se o esgotamento do espaço em aterros sanitários. Colabore mantendo este produto fora da rede de recolha de resíduos urbanos! O símbolo de "caixote de lixo móvel" significa que o produto deverá ser recolhido como "resíduo de equipamento eléctrico e electrónico". Pode devolver um produto antigo à loja quando compra outro semelhante. Contacte as autoridades locais relativamente à disponibilidade de outras opções.

RU Требуется элементы питания: три элемента питания типа AA/LR6 и один элемент питания 9 В/PP3 (не входят в комплект). Элементы питания и комплекты элементов питания необходимо утилизировать надлежащим образом. По окончании срока эксплуатации не выбрасывайте игрушку вместе с бытовыми отходами. Согласно закону об утилизации электрических и электронных устройств ее необходимо утилизировать отдельным способом, с использованием наиболее подходящих технологий утилизации и переработки. Это позволит снизить негативные последствия для окружающей среды и здоровья человека, уменьшит загрязнение воды и почвы опасными веществами, а также снизит количество ресурсов, необходимых для изготовления новых игрушек и сократит объем мусора на городских свалках. Внесите свой вклад, сохранив город чистым. Значок с изображением перечеркнутой корзины означает, что игрушку следует утилизировать согласно закону об утилизации электрических и электронных устройств. При покупке новой игрушки вы можете вернуть старую в магазин. Чтобы узнать о других возможных вариантах утилизации, обратитесь в местную перерабатывающую организацию.

GB. Remove all packaging before use. Retain this information, addresses and phone numbers for future reference. Content may vary from pictures. Meccano reserves the right to discontinue the website www.meccano.com at any time. An adult should periodically check this toy to ensure no damage or hazard exist if so, remove from use. Children should be supervised during play.

F. Retirer tout l'emballage avant utilisation. Conserver les informations, adresses et numéros de téléphone pour consultation ultérieure. Le contenu peut différer des images. Meccano se réserve le droit de supprimer le site Internet www.meccano.com à tout moment. Un adulte doit régulièrement examiner ce jouet afin de s'assurer qu'il ne présente pas de dommage ni de risque. En cas de problème, ne plus l'utiliser. Les enfants doivent être surveillés lorsqu'ils jouent.

E. Retire todo el embalaje antes de utilizar el producto. Conserve toda la información, las direcciones y los números de teléfono para futuras referencias. El contenido del paquete puede no corresponder con las imágenes. Mecano se reserva el derecho a suspender el sitio web www.meccano.com en cualquier momento. Un adulto debe revisar de forma periódica el juguete para asegurarse de que no supone un riesgo o peligro para el niño; si así fuera el caso, interrumpa su uso. Supervise a los niños mientras juegan con el producto.

D. Entfernen Sie vor der Benutzung sämtliche Verpackungsmaterialien. Alle Informationen, Adressen und Telefonnummern bitte für mögliche Rückfragen aufbewahren. Der Packungsinhalt kann von den Bildern abweichen. Meccano behält sich das Recht vor, den Betrieb der Website www.meccano.com jederzeit einzustellen. Ein Erwachsener sollte regelmäßig sicherstellen, dass das Spielzeug keine Gefahr darstellt, und es gegebenenfalls entfernen. Kinder sollten beim Spielen beaufsichtigt werden.

NL. Verwijder de verpakking voor gebruik. Bewaar deze informatie, adressen en telefoonnummers voor toekomstig gebruik. Inhoud kan afwijken van illustraties. Meccano behoudt zich het recht voor de website www.meccano.com wanneer gewenst buiten gebruik te stellen. Een volwassene dient dit speelgoed regelmatig te controleren op schade en gevaren. Indien het speelgoed is beschadigd of indien er een gevaarlijke situatie kan ontstaan, dient het product te worden weggegooid. Ouderlijk toezicht is vereist als kinderen met dit speelgoed spelen.

I. Rimuovere l'imballo prima dell'uso. Conservare informazioni, indirizzi e numeri di telefono per riferimento futuro. Il prodotto essere differente dalle immagini. Meccano si riserva il diritto di rimuovere il sito www.meccano.com in qualsiasi momento. È consigliabile un controllo periodico del giocattolo da

parte di un adulto: in caso di danni o rischi interrompere l'uso. È richiesta la supervisione di un adulto durante il gioco.

P. Remova totalmente a embalagem antes de utilizar. Guarde todos os endereços, números de telefone e demais informações para consulta e referência. O conteúdo poderá ser diferente das ilustrações. A Meccano reserva-se o direito de descontinuar o site www.meccano.com a qualquer altura. Um adulto deve verificar o brinquedo periodicamente para garantir que ele não apresenta danos ou riscos. Se houver, é necessário que o brinquedo seja retirado de uso. Crianças devem ser supervisionadas enquanto brincam.

R. Снимите все упаковочные материалы перед использованием. Запишите указанные на упаковке адреса и номера телефонов, чтобы у вас была возможность связаться с нами. Содержимое упаковки может отличаться от иллюстрации. Компания Meccano оставляет за собой право прекратить использование сайта www.meccano.com в любое время. Регулярно проверяйте состояние игрушки на наличие повреждений и возможных рисков для ребенка. Если таковые имеются, игрушку не следует использовать. Во время игры за детьми следует присматривать.

- ⚠ Warning: CHOKING HAZARD – Small parts.
- ⚠ Attention ! RISQUE D'ETOUFFEMENT – Contient de petits éléments.
- ⚠ Advertencia: PELIGRO DE ASFIXIA – Contiene piezas pequeñas No conveniente para niños menores de 3 años.
- ⚠ Achtung: ERSTICKUNGSGEFAHR – Kleinteile.
- ⚠ Waarschuwing: VERSTIKKINGSGEVAAR – Kleine onderdelen.
- ⚠ Attenzione: RISCHIO DI SOFFOCAMENTO – Pezzi piccoli.
- ⚠ Aviso: PERIGO DE ASFIXIA – Peças pequenas.
- ⚠ Осторожно! ОПАСНОСТЬ ДУДУШЬЯ – Мелкие детали.

- ⚠ CAUTION: Stickers not intended to be placed on skin.
- ⚠ MISE EN GARDE: Les autocollants ne sont pas destinés à être placés sur la peau.
- ⚠ PRECAUCIÓN: Las calcomanías no deben colocarse sobre la piel.
- ⚠ ACHTUNG: Sticker sind nicht zum Aufkleben auf die Haut geeignet.
- ⚠ VOORZICHTIG: Stickers zijn niet voor op de huid bedoeld.
- ⚠ ATTENZIONE: Non applicare gli adesivi sulla pelle.
- ⚠ ATENÇÃO: os autocolantes não devem ser colocados na pele.
- ⚠ ОСТОРОЖНО: Стикеры не предназначены для приклеивания к коже.



UK – 0800 206 1191, SERVICEUK@SPINMASTER.COM
FRANCE – 0800 909 150, SERVICEFR@SPINMASTER.COM
ESPAÑA – SERVICIO@SPINMASTER.COM
DEUTSCHLAND – 00800 0101 0222, KUNDENSERVICE@SPINMASTER.COM
SCHWEIZ – 0800 561 350 • ÖSTERREICH – 0800 29 72 67
NEDERLAND – 0800 022 36 83, KLANTENSERVICE@SPINMASTER.COM
BELGIË/BELGIQUE – 0800 77 688 • LUXEMBOURG – 800 28 044
ITALIA – 800 788 532, SERVIZIO@SPINMASTER.COM
MEXICO - (55) 5351-4400



WWW.SPINMASTER.COM

SPIN MASTER LTD., 450 FRONT STREET WEST, TORONTO, ON M5V 1B6 CANADA.
IMPORTED INTO EU BY SPIN MASTER INTERNATIONAL, S.A.R.L.,
16 AVENUE PASTEUR, L-2310, Luxembourg. www.spinmaster.com
Made in China / Fabriqué en Chine / Hecho en China



TM & © 2015 MECCANO for packaging, instructions and models built with this set. TM & © 2015 MECCANO pour l'emballage, les notices et modèles de ce coffret. © MECCANO is an exclusive trademark of MECCANO. Spin Master logo is a trademark of Spin Master Ltd. © MECCANO est une marque de commerce exclusive de MECCANO. Le logo de Spin Master est une marque de commerce de Spin Master Ltd. All rights reserved. Tous droits réservés.
T91780_0001_20070939_GML_IB_R2_MEC_Auto Cross_CN