

MECCANOTM
M A K E R S Y S T E M

**CONSTRUCTION CREW
CHANTIER**

MAKES
POUR CONSTRUIRE

5

MODELS
MODÈLES • MODELOS

15203



 **8+**

Instructions
Notice de montage
Instrucciones de construcción
Bauanleitung

Bouwinstructie
Istruzioni
Instruções
Инструкции



NEW TOOLS / NOUVEAUX OUTILS

NUEVAS HERRAMIENTAS / NEUE WERKZEUGE

NIEUW GEREEDSCHAP / NUOVI ATTREZZI

NOVAS FERRAMENTAS / НОВЫЕ ИНСТРУМЕНТЫ

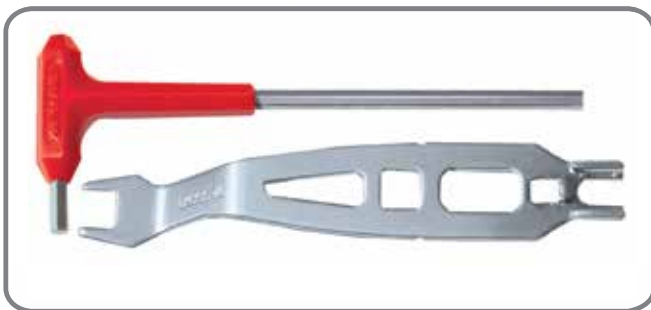

1:1

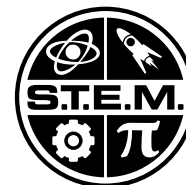

GB. For information on how this product supports today's STEM curriculum, visit www.meccano.com.

F. Pour découvrir l'intérêt pédagogique de ce produit dans le cadre des matières STEM, rendez-vous sur www.meccano.com.

E. Para mayor información sobre cómo este producto respalda las materias STEM visita: www.meccano.com.

D. Für Informationen wie dieses Produkt den technisch-mathematischen Lehrplan (STEM) unterstützt, besuchen Sie bitte www.meccano.com.

NL. Ga naar www.meccano.com voor meer informatie over hoe dit product het huidige STEM-curriculum ondersteunt.

I. Per informazioni su come questo prodotto contribuisce ad aiutare i ragazzi nelle materie STEM "scientifiche e tecniche", visitare il sito www.meccano.com.

P. Para informações sobre a compatibilidade deste produto com os programas atuais STEM, acesse www.meccano.com.

R. Информация о том, как с помощью этого продукта можно повысить эффективность процесса изучения дисциплин STEM, представлена на сайте www.meccano.com.

TABLE OF CONTENTS/SOMMAIRE

ÍNDICE / INHALTSVERZEICHNIS / INHOUD / INDICE / ÍNDICE / СОДЕРЖАНИЕ



4



11



17

AVAILABLE ONLINE / DISPONIBLES EN LIGNE
DISPONIBLES EN LÍNEA / ONLINE VERFÜGBAR /
ONLINE BESCHIKBAAR / DISPONIBILI ONLINE /
DISPONÍVEL ONLINE / ДОСТУПНЫ В
ОНЛАЙН-МАГАЗИНЕ





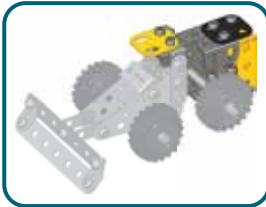

GB. Content : 95 parts, 2 real tools and 1 instruction sheet for 3 models.
F. Contenu : 95 pièces, 2 vrais outils et 1 notice de montage pour 3 modèles.
E. Contenido: 95 piezas, 2 herramientas reales y 1 guía de instrucciones para 3 modelos.
D. Inhalt: 95 Teile, 2 echte Werkzeuge und 1 Bauanleitung für 3 Modelle.
NL. Inhoud: 95 onderdelen, 2 stuks gereedschap en 1 bouw instructie voor 3 modellen.
I. Contenuto: 95 pezzi, 2 attrezzi e 1 guida per l'uso per 3 modelli.
P. Conteúdo: 95 peças, 2 ferramentas reais e 1 folha de instruções para 3 modelos.
R. В коробке: 95 деталей, 2 настоящих инструмента и 1 инструкция по сборке 3 моделей.

GB. Building instructions for the 2 other models are available at www.meccano.com.
F. Les notices de montage des 2 autres modèles sont disponibles sur www.meccano.com.
E. Hay instrucciones de construcción disponibles para los otros 2 modelos en www.meccano.com.
D. Bauanleitungen für die anderen 2 Modelle sind auf www.meccano.com zu finden.
NL. Bouwinstructies voor de andere 2 modellen zijn beschikbaar op www.meccano.com.
I. Le istruzioni di montaggio degli altri 2 modelli sono disponibili alla pagina www.meccano.com.
P. Instruções de montagem dos restantes 2 modelos disponíveis em www.meccano.com.
R. Инструкции по сборке 2 других моделей можно найти на сайте www.meccano.com.

GB. Only one model can be built at a time. **F.** Les pièces fournies ne permettent de monter qu'un seul modèle à la fois. **E.** Solo es posible construir un modelo a la vez. **D.** Jeweils nur eins der Modelle baubar. **NL.** Er kan maar een model tegelijk worden gebouwd. **I.** Permette di realizzare un solo modello per volta. **P.** Só é possível montar um modelo de cada vez. **R.** Одновременно можно построить только одну модель.



1

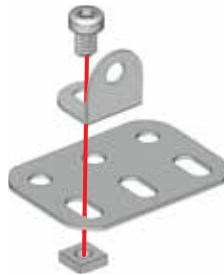

-  **x1**
-  **x1**
-  **x1**
-  **x1**



- | | | |
|--|-----------|------------|
|  | S1 | 1:1 |
|--|-----------|------------|



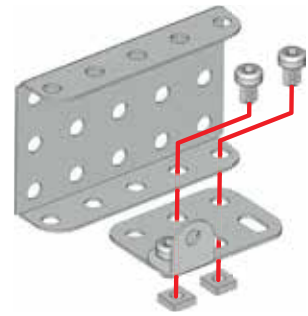

2

-  **x1**
-  **x2**
-  **x2**



- | | | |
|---|-----------|------------|
|  | S1 | 1:1 |
|---|-----------|------------|



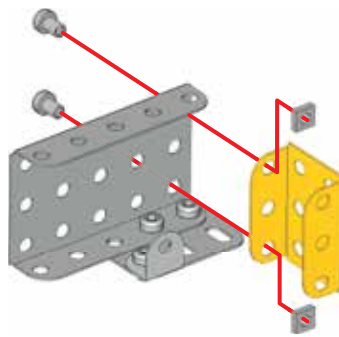

3

	x1
 5,8 mm 15/64"	x2
	x2

	1:1
---	------------





4

	x1
	x1
 5,8 mm 15/64"	x1
	x1

	1:1
--	------------





5 ③ + ④ +

 5,8 mm 15/64"	x2
	x2

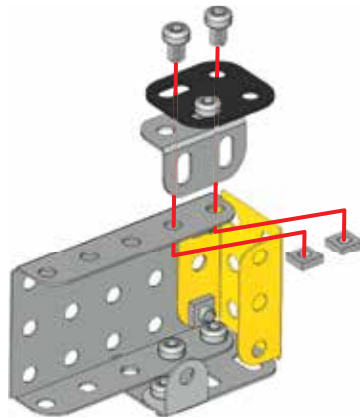
	1:1
---	------------



6

	x1
 5,8 mm 15/64"	x1
	x1

	1:1
---	------------

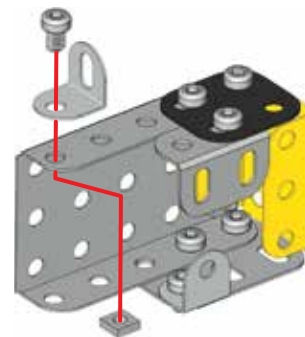

7

	x1
	x2
	x2
	x2

	S1	1:1
--	-----------	------------

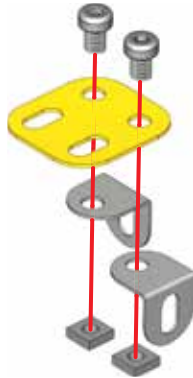

8 ⑥ + ⑦ +

	S1	5,8 mm 15/64"	x1
			x1

	S1	1:1
--	-----------	------------

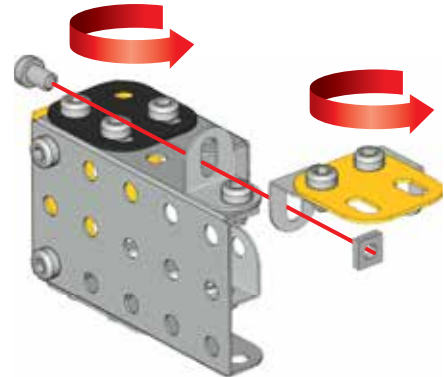



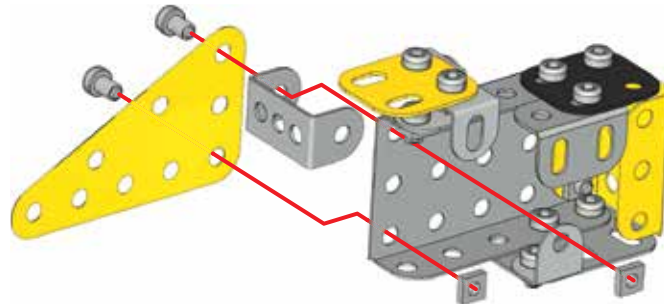

9

	x1		
	x1		
	S1	5,8 mm 15/64"	x2
			x2

	S1	1:1
--	-----------	------------





10

-  **x1**
-  **x1**
-  5,8 mm | **x2**
15/64"
-  **x2**

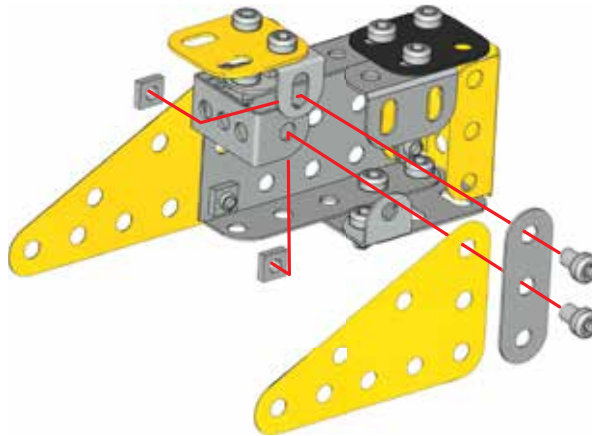
 **S1** **1:1**



11

-  **x1**
-  5,8 mm | **x2**
15/64"
-  **x2**

 **S1** **1:1**

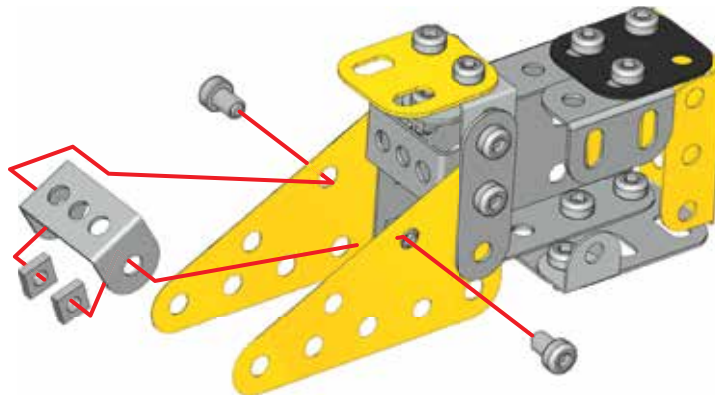

12

	x1
	x1
	x1
	x1

	S1	1:1
--	-----------	------------

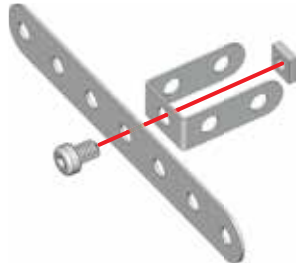

13

	x1
	x2
	x2
	x2

	S1	1:1
--	-----------	------------

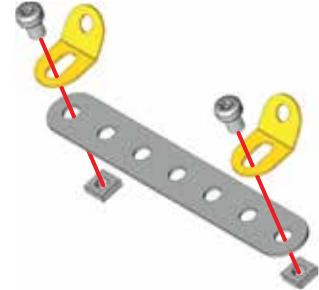

14 (12) + (13) +

	x2
	x2

	S1	1:1
--	-----------	------------

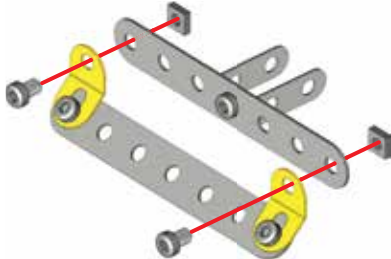

15 (11) + (14) +

	x2
	x2

	S1	1:1
--	-----------	------------

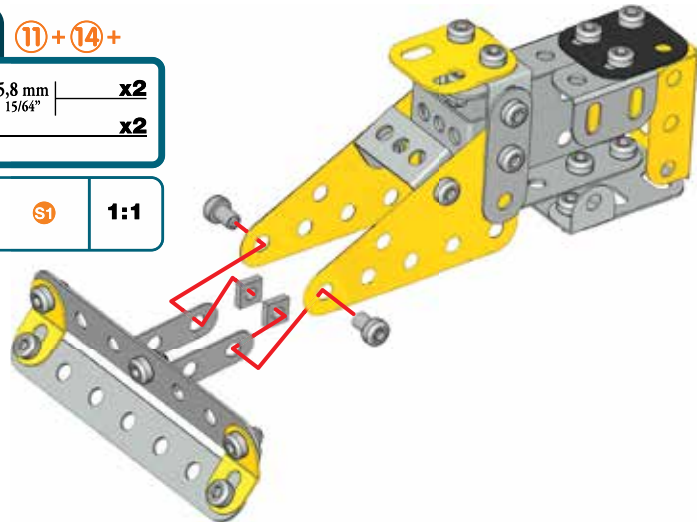

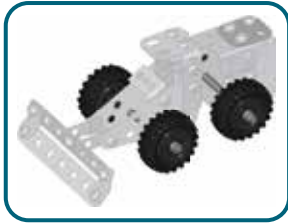

16

	x4
	x4

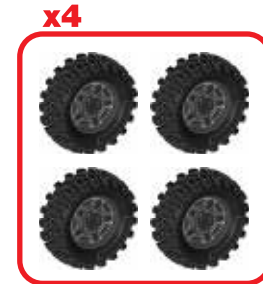

17 (15) + (16) +

	75 mm 3"	x1
		x4
		x2

		A238	1:1

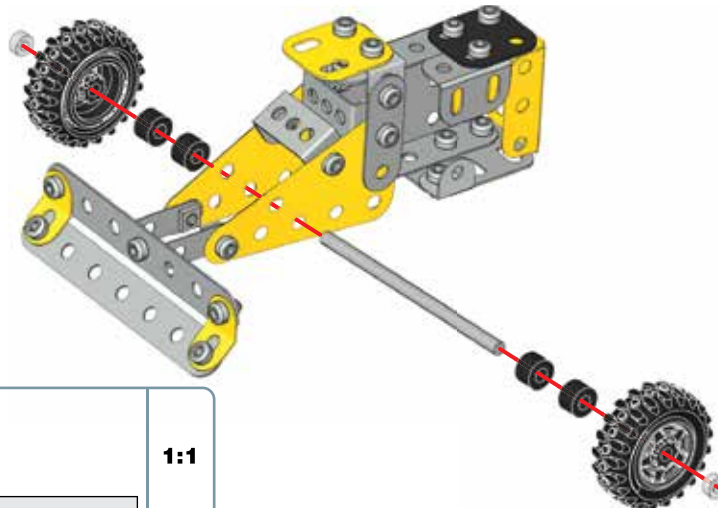

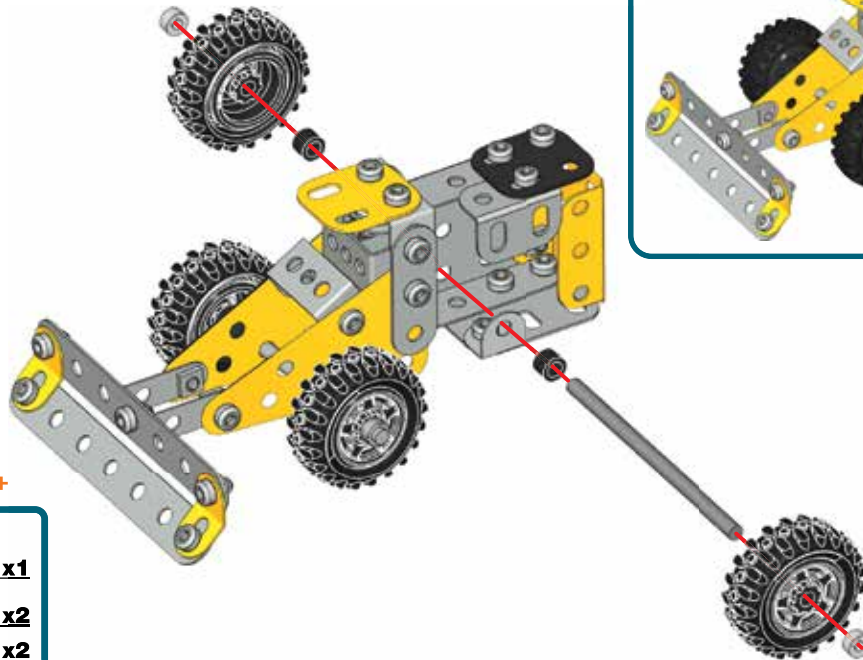





18 (16) + (17) +

	75 mm 3"	x1
		x2
		x2

	A338	1:1



- 1**
-  **x2**
 -  **x1**
 -  **S1** | 5,8 mm | **x2**
 -  **x2**

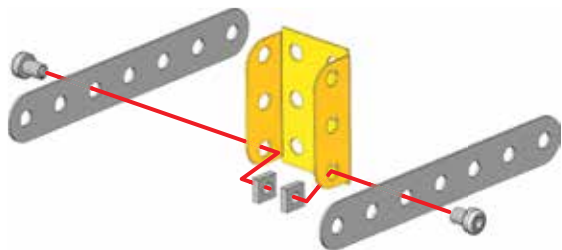

2

	x1
	x2
	x2
	x2

	S1	1:1
--	----	-----

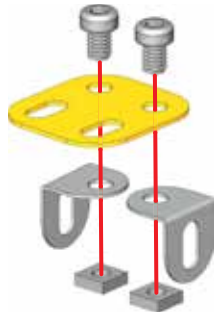

3 ① + ② +

	5,8 mm 15/64"	x1
		x1

	S1	1:1
--	----	-----

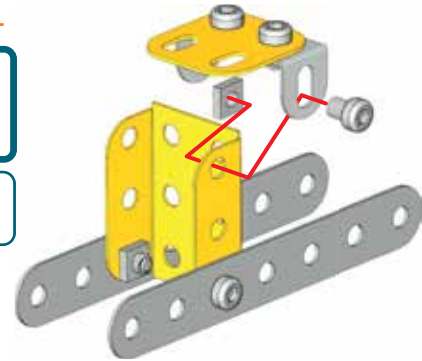

4

	5,8 mm 15/64"	x1
		x1

	S1	1:1
--	----	-----

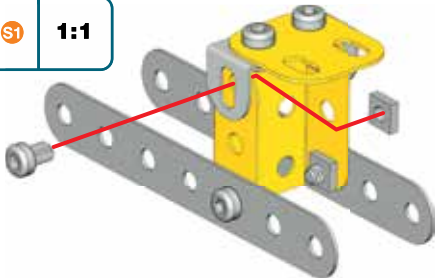



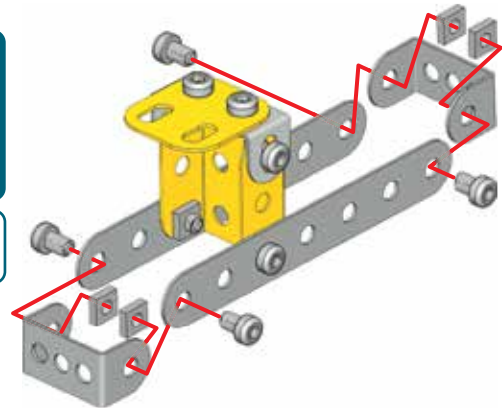

5

		x2
	5,8 mm 15/64"	x4
		x4

	S1	1:1
--	----	-----





6

	x1
	x1
	x2
	x2

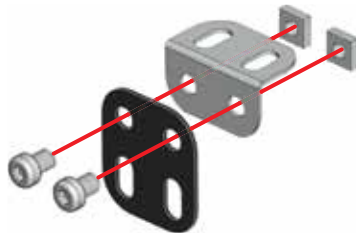
	S1	1:1
---	-----------	------------



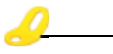

7

	x2
	x2
	x2

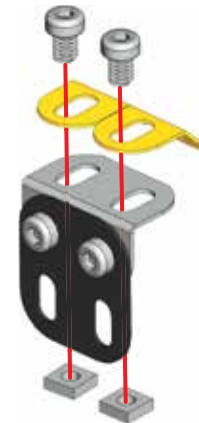
	S1	1:1
--	-----------	------------





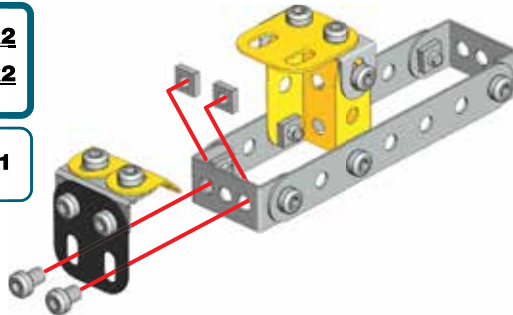

8 (5) + (7) +

	x2
	x2

	S1	1:1
---	-----------	------------





9

	x1
	x1
	x1
	x1

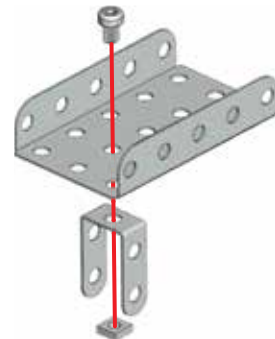
	S1	1:1
--	-----------	------------





10

	x2
 5,8 mm 15/64"	x4
	x4

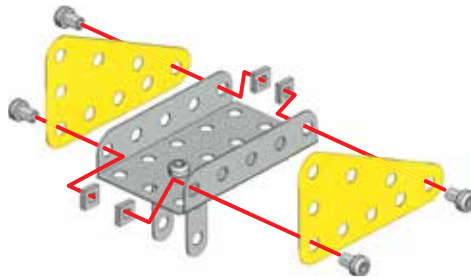
	S1	1:1
---	-----------	------------





11

	x2
 5,8 mm 15/64"	x2
	x2

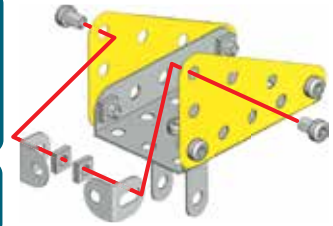
	S1	1:1
--	-----------	------------





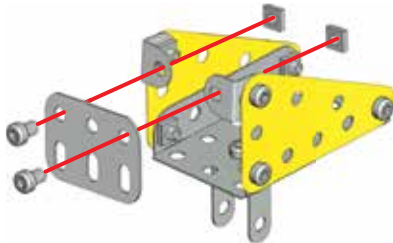

12

	x2
 5,8 mm 15/64"	x2
	x2

	S1	1:1
---	-----------	------------



13

	x1
	x1
 5,8 mm 15/64"	x2
	x2

	S1	1:1
--	-----------	------------

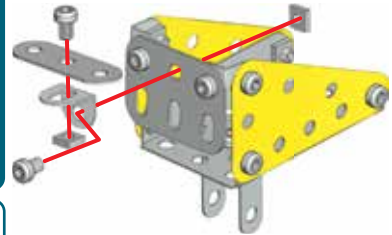

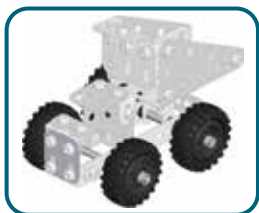



14

 **x2**

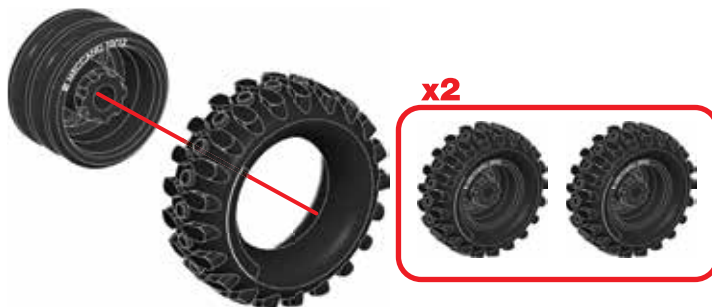
 **x2**



15

 **x2**

 **x2**

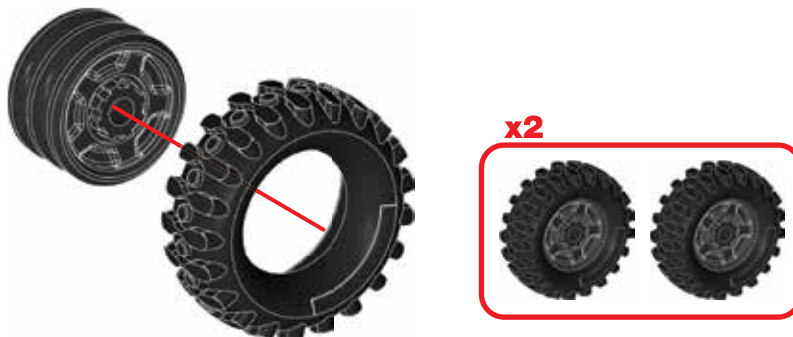

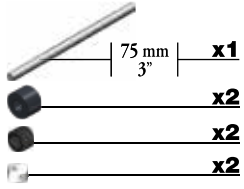
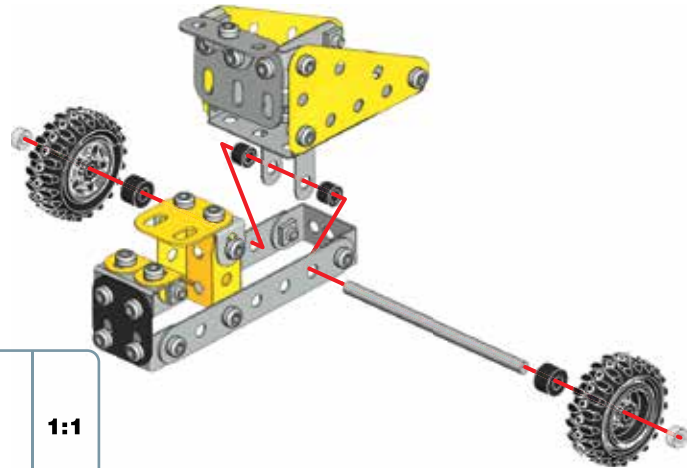
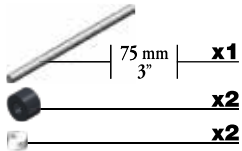
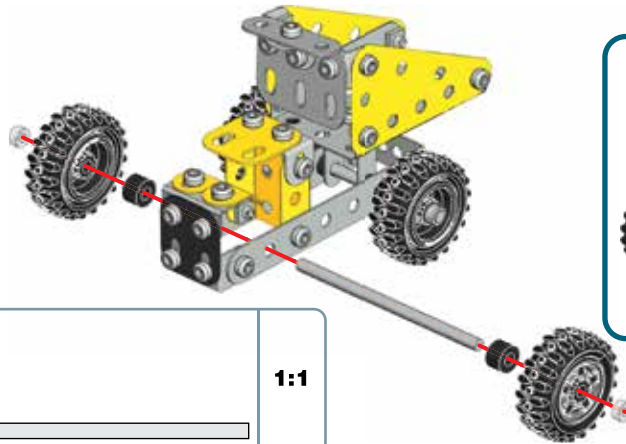
16**(8) + (13) + (14) +****1:1****17****(15) + (16) +****1:1**

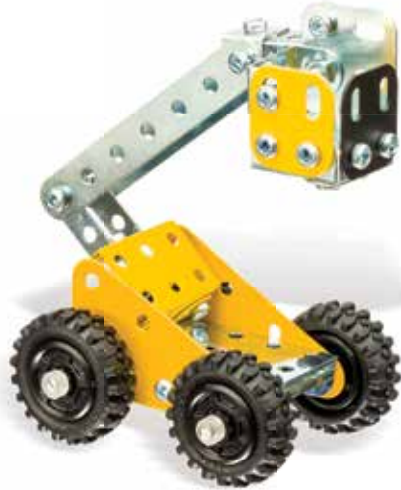

1

	x1
	x2
	x2
	x2

	S1	1:1
--	-----------	------------

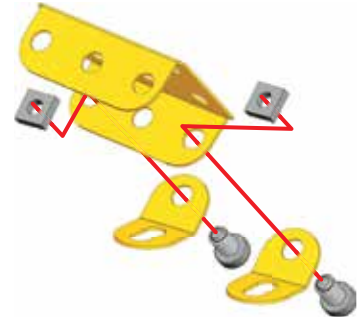

2

	x1
	x2
	x2

	S1	1:1
--	-----------	------------

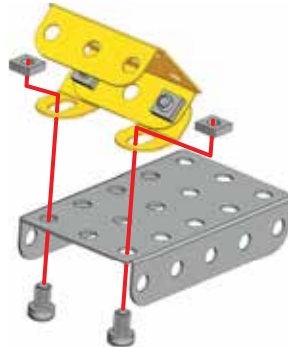

3

	x1
	x1
	x1

	S1	1:1
--	-----------	------------

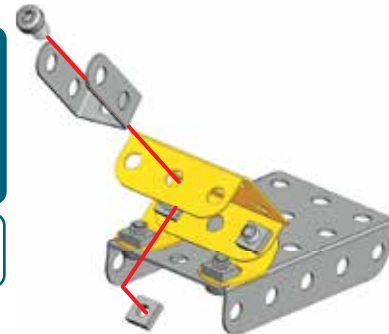

4

	x1
	x1
	x1
	x1

	S1	1:1
--	-----------	------------

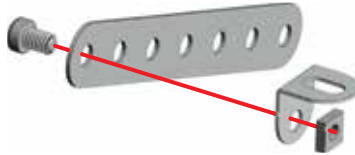

5 **3 + 4 +**

	S1	5,8 mm 15/64"	x1
			x1

	S1	1:1
--	-----------	------------

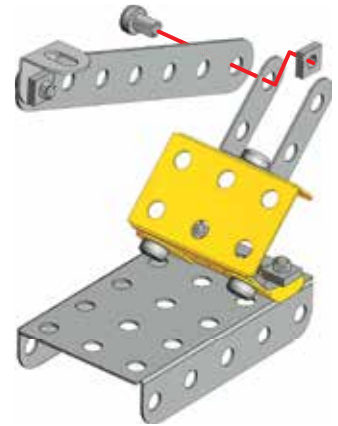

6

	x1
	x1
	x1
	x1

	S1	1:1
--	-----------	------------

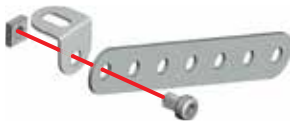

7 **5 + 6 +**

	S1	5,8 mm 15/64"	x1
			x1

	S1	1:1
--	-----------	------------

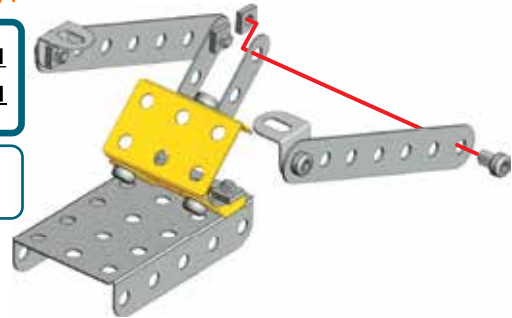

8

	x1
	x1
	x2
	x2

	S1	1:1
--	-----------	------------

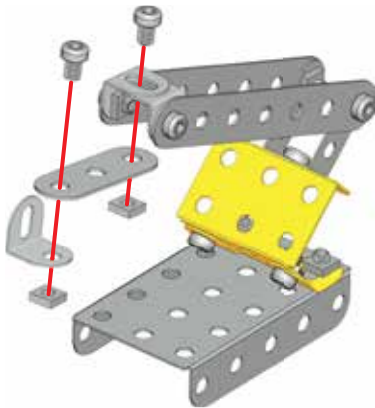

9

	x1
	x1
	x1

	S1	1:1
--	-----------	------------

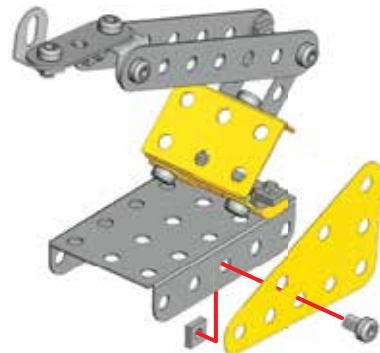

10

	x1
	x1
	x1

	S1	1:1
--	-----------	------------

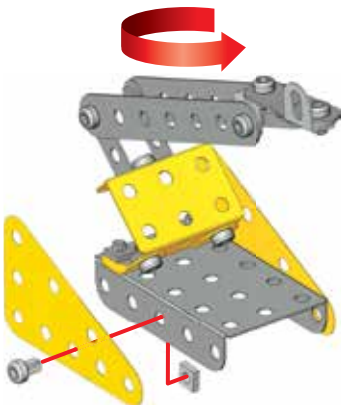



11

	x1
	x2
	x2
	x2

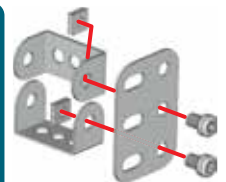
	S1	1:1
--	-----------	------------





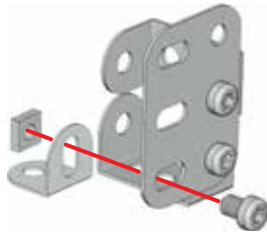

12

	x1
 5,8 mm 15/64"	x1
	x1



		1:1
---	---	-----

**13**

	x1
	x1
 5,8 mm 15/64"	x3
	x3

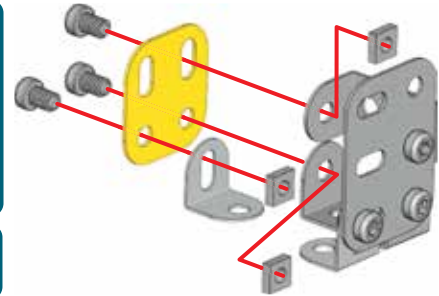

		1:1
---	--	-----

**14**

	x1
 5,8 mm 15/64"	x2
	x2

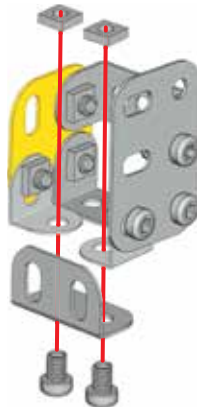
		1:1
--	--	-----



**15**

	x1
 5,8 mm 15/64"	x2
	x2

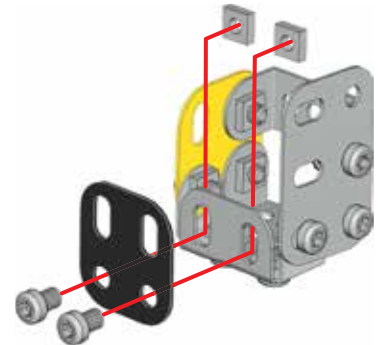
		1:1
--	--	-----





16 10 + 15 +

	5,8 mm 15/64"	x1
		x1

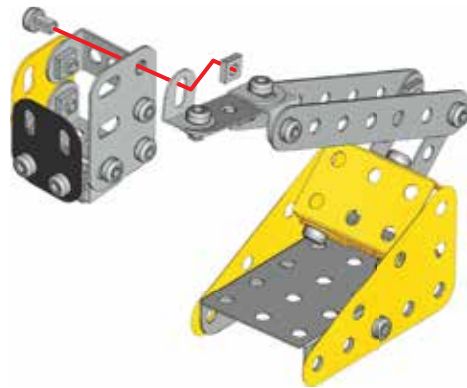
	S1	1:1
---	----	------------





17

	x4
	x4

x4

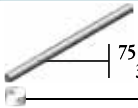

18 16 + 17 +

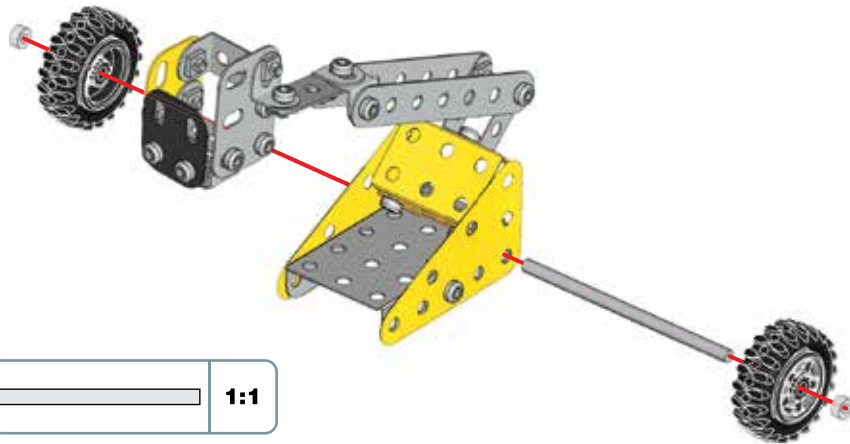

	75 mm 3"	x1
		x2

	1:1
---	------------

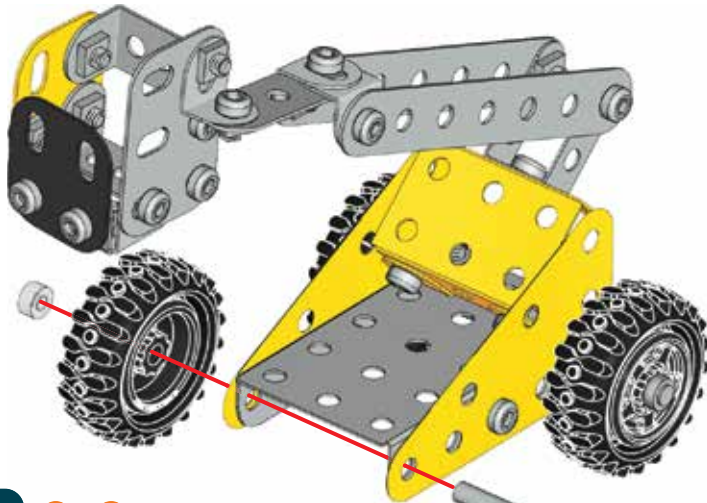



19 (17) + (18) +

	75 mm 3"	x1
		x2

	1:1
---	------------





A251 (0051F) x 1



A221 (0221) x 2



A252 (0051A) x 1



A307 (0103H) x 1



A503 (0103L) x 1



A503 (0103L) x 1



A436 (0811A) x 1



A381 (0142F) x 4



C876 x 4



A548 (0048E) x 2



A506 (0006A) x 1



A309 (0009L) x 1



A012 (0012) x 5



A712 (0012C) x 2



A203 (0003) x 2

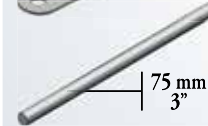

A016 (0016B) x 2



A238 (0038A) x 4



A338 (0038B) x 2



A259 (0059C) x 4



A637 (0037B) x 27



A337 (0037A) x 27



C995 x 1



C993 x 1

GB. Remove all packaging before use. Retain this information, addresses and phone numbers for future reference. Content may vary from pictures. Meccano reserves the right to discontinue the website www.meccano.com at any time. An adult should periodically check this toy to ensure no damage or hazard exist if so, remove from use. Children should be supervised during play.

F. Retirer tout l'emballage avant utilisation. Conserver les informations, adresses et numéros de téléphone pour consultation ultérieure. Le contenu peut différer des images. Meccano se réserve le droit de supprimer le site Internet www.meccano.com à tout moment. Un adulte doit régulièrement examiner ce jouet afin de s'assurer qu'il ne présente pas de dommage ni de risque. En cas de problème, ne plus l'utiliser. Les enfants doivent être surveillés lorsqu'ils jouent.

E. Retire todo el embalaje antes de utilizar el producto. Conserve toda la información, las direcciones y los números de teléfono para futuras referencias. El contenido del paquete puede no corresponder con las imágenes. Meccano se reserva el derecho a suspender el sitio web www.meccano.com en cualquier momento. Un adulto debe revisar de forma periódica el juguete para asegurarse de que no supone un riesgo o peligro para el niño; si así fuera el caso, interrumpa su uso. Supervise a los niños mientras juegan con el producto.

D. Entfernen Sie vor der Benutzung sämtliche Verpackungsmaterialien. Alle Informationen, Adressen und Telefonnummern bitte für mögliche Rückfragen aufbewahren. Der Packungsinhalt kann von den Bildern abweichen. Meccano behält sich das Recht vor, den Betrieb der Website www.meccano.com jederzeit einzustellen. Ein Erwachsener sollte regelmäßig sicherstellen, dass das Spielzeug keine Gefahr darstellt, und es gegebenenfalls entfernen. Kinder sollten beim Spielen beaufsichtigt werden.

NL. Verwijder de verpakking voor gebruik. Bewaar deze informatie, adressen en telefoonnummers voor toekomstig gebruik. Inhoud kan afwijken van illustraties. Meccano behoudt zich het recht voor de website www.meccano.com wanneer gewenst buiten gebruik te stellen. Een volwassene dient dit speelgoed regelmatig te controleren op schade en gevaren. Indien het speelgoed is beschadigd of indien er een gevaarlijke situatie kan ontstaan, dient het product te worden weggegooid. Ouderlijk toezicht is vereist als kinderen met dit speelgoed spelen.

I. Rimuovere l'imballo prima dell'uso. Conservare informazioni, indirizzi e numeri di telefono per riferimento futuro. Il prodotto potrebbe essere differente dalle immagini. Meccano si riserva il diritto di rimuovere il sito www.meccano.com in qualsiasi momento. È consigliabile un controllo

periodico del giocattolo da parte di un adulto: in caso di danni o rischi interrompere l'uso. È richiesta la supervisione di un adulto durante il gioco.

P. Remova totalmente a embalagem antes de utilizar. Guarde todos os endereços, números de telefone e demais informações para consulta e referência. O conteúdo poderá ser diferente das ilustrações. A Meccano reserva-se o direito de descontinuar o site www.meccano.com a qualquer altura. Um adulto deve verificar o brinquedo periodicamente para garantir que não ele não apresenta danos ou riscos. Se houver, é necessário que o brinquedo seja retirado de uso. Crianças devem ser supervisionadas enquanto brincam.

R. Снимите все упаковочные материалы перед использованием. Запишите указанные на упаковке адреса и номера телефонов, чтобы у вас была возможность связаться с нами. Содержимое упаковки может отличаться от иллюстраций. Компания Meccano оставляет за собой право прекратить использование сайта www.meccano.com в любое время. Регулярно проверяйте состояние игрушки на наличие повреждений и возможных рисков для ребенка. Если таковые имеются, игрушку не следует использовать. Во время игры за детьми следует присматривать.

- △ Warning: CHOKING HAZARD – Small parts.
- △ Attention ! RISQUE D'ÉTOUFFEMENT – Contient de petits éléments.
- △ Advertencia: PELIGRO DE ASFIXIA – Contiene piezas pequeñas No conveniente para niños menores de 3 años.
- △ Achtung: ERSTICKUNGSGEFAHR – Kleinteile.
- △ Waarschuwing: VERSTIKKINGSGEVAAR – Kleine onderdelen.
- △ Attenzione: RISCHIO DI SOFFOCAMENTO – Pezzi piccoli.
- △ Aviso: PERIGO DE ASFIXIA – Peças pequenas.
- △ Осторожно! ОПАСНОСТЬ УДУШЬЯ - Мелкие детали.



UK – 0800 206 1191, SERVICEUK@SPINMASTER.COM
FRANCE – 0800 909 150, SERVICEFR@SPINMASTER.COM
ESPAÑA – SERVICIO@SPINMASTER.COM
DEUTSCHLAND – 00800 0101 0222, KUNDENSERVICE@SPINMASTER.COM
SCHWEIZ – 0800 561 350 • ÖSTERREICH – 0800 29 72 67
NEDERLAND – 0800 022 36 83, KLANTENSERVICE@SPINMASTER.COM
BELGIË/BELGIQUE – 0800 77 688 • LUXEMBOURG – 800 28 044
ITALIA – 800 788 532, SERVIZIO@SPINMASTER.COM
MEXICO – 53.51.44.00
WWW.SPINMASTER.COM

NORTH AMERICA :
AMÉRIQUE DU NORD : 1-800-622-8339 customercare@spinmaster.com

SPIN MASTER LTD., 450 FRONT STREET WEST, TORONTO, ON M5V 1B6 CANADA.
DISTRIBUTED IN EU BY SPIN MASTER INTERNATIONAL, S.A.R.L.,
16 AVENUE PASTEUR, L-2310, Luxembourg. www.spinmaster.com
Made in France / Fabriqué en France / Hecho en Francia
Meccano : 363, avenue de Saint-Exupéry 62100 Calais - France



TM & © 2015 MECCANO for packaging, instructions and models built with this set. TM & © 2015 MECCANO pour l'emballage, les notices et modèles de ce coffret. © MECCANO is an exclusive trademark of MECCANO. Spin Master logo is a trademark of Spin Master Ltd. © MECCANO est une marque de commerce exclusive de MECCANO. Le logo de Spin Master est une marque de commerce de Spin Master Ltd. All rights reserved. Tous droits réservés.
T91785_0002_20070942_GML_IB_R1_MEC_5 Models Set_FR