

15202



**8+**

Instructions  
Notice de montage  
Instrucciones de construcción

Bauanleitung  
Bouwinstructie

Instruções  
Инструкции

Content: 87 parts, 2 tools, 1 instruction sheet  
Contenu : 87 pièces, 2 outils, 1 notice de montage  
Contenido: 87 piezas, 2 herramientas, 1 guía de instrucciones  
Inhalt: 87 Teile, 2 Werkzeuge, 1 Bauanleitung  
Inhoud: 87 onderdelen, 2 stuks gereedschap, 1 bouw instructie  
Contenuto: 87 pezzi, 2 attrezzi, 1 guida per l'uso  
Conteúdo: 87 peças, 2 ferramentas, 1 folha de instruções  
В коробке: 87 деталей, 2 инструменты, 1 инструкция

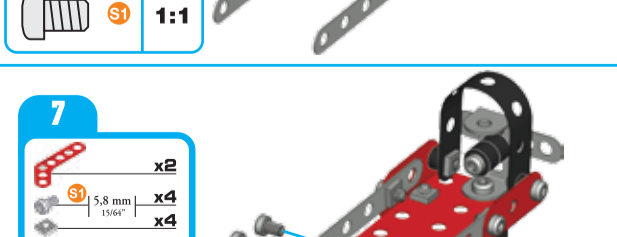
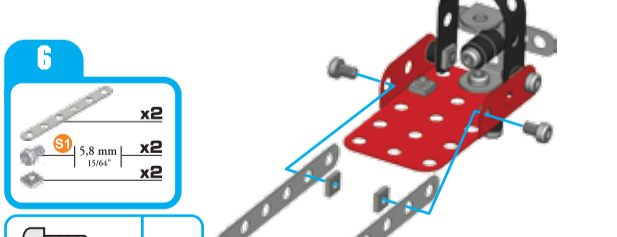
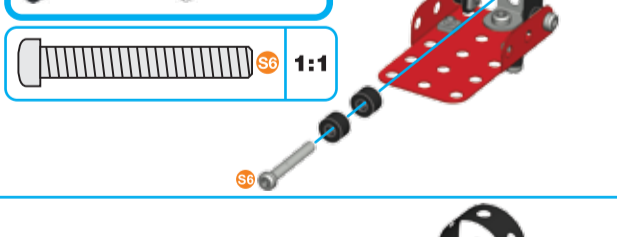
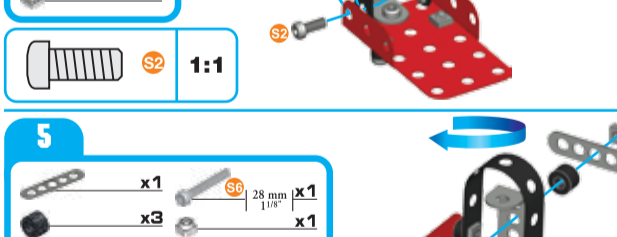
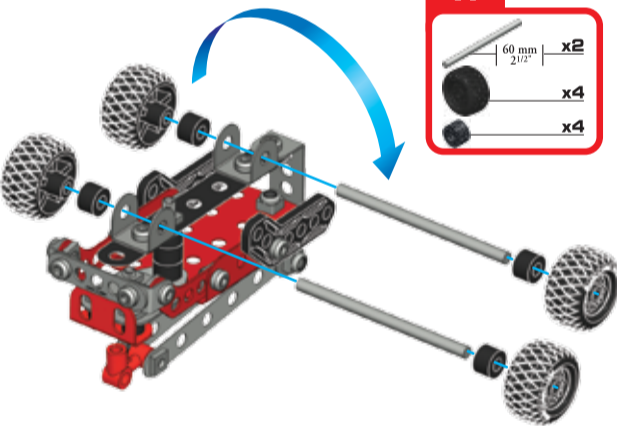
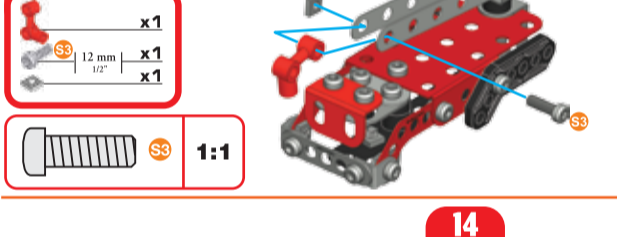
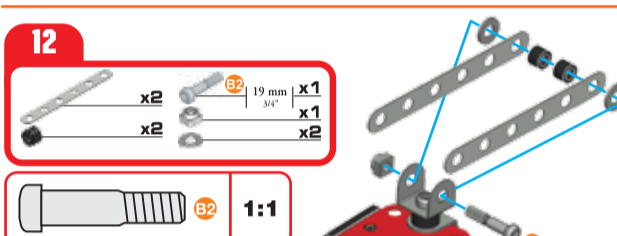
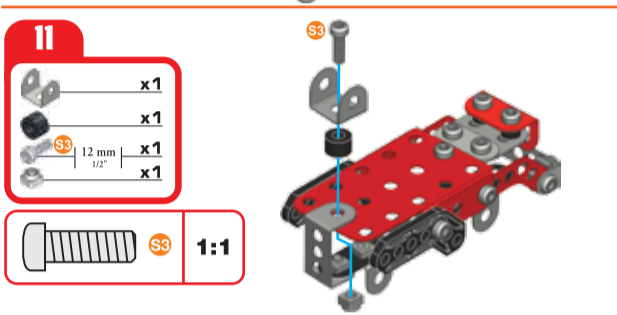
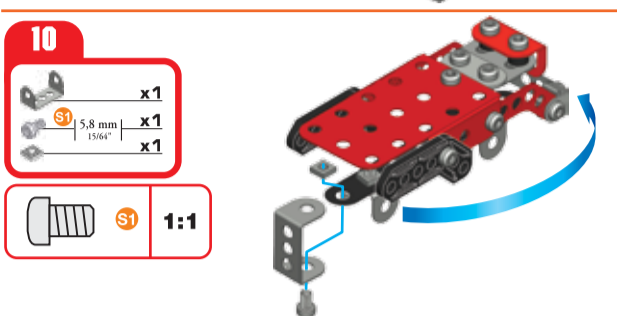
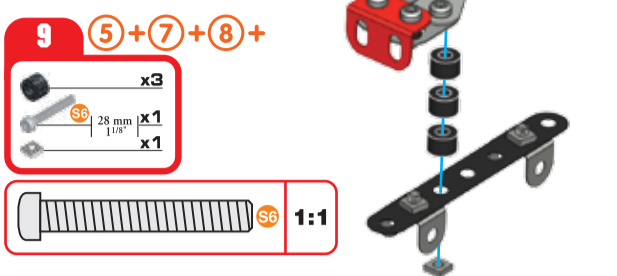
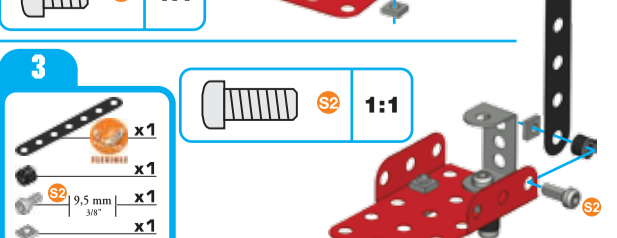
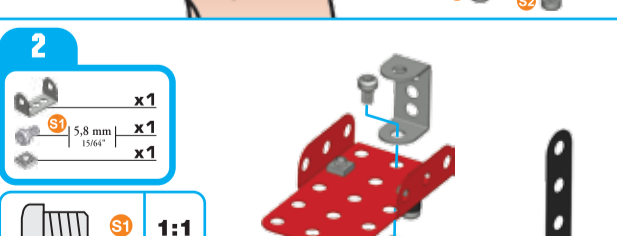
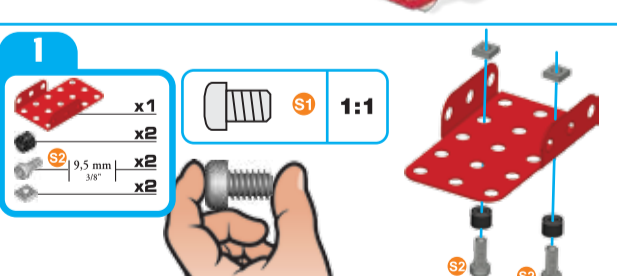
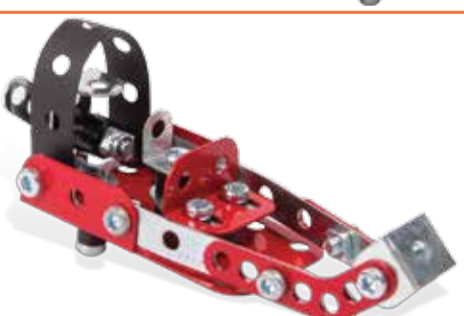
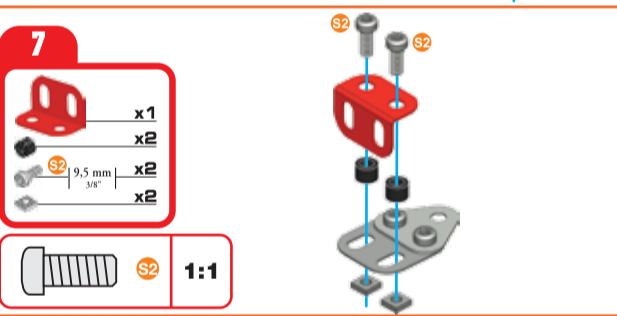
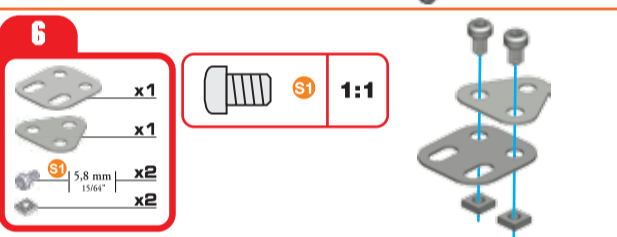
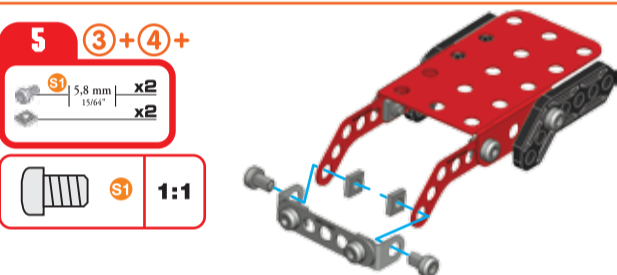
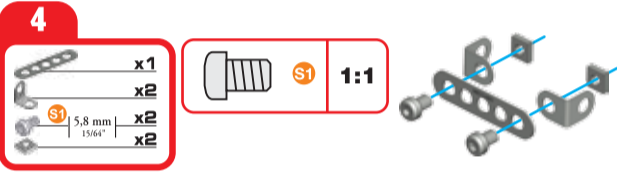
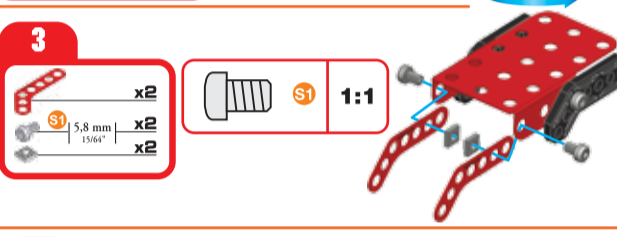
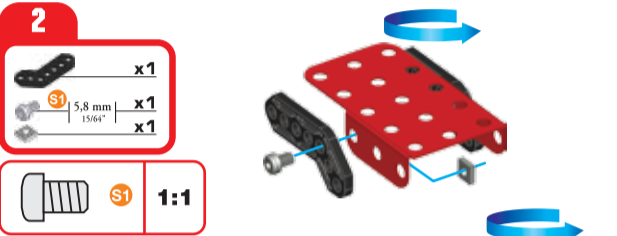
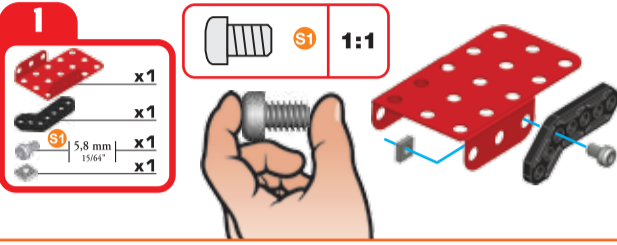

**8**

- x1
- x1 5,8 mm 15/64"
- x1

S1 1:1

**10**

- x1
- x1
- x2 5,8 mm 15/64"
- x2

S1 1:1

**9**

- x1 5,8 mm 15/64"
- x1

S1 1:1

**11** 9+10+

- x1
- x2
- x1 19 mm 3/4"
- x1

B2 1:1

**1**

- x1
- x1
- x1 5,8 mm 15/64"
- x1

S1 1:1

**7**

- x1
- x1 5,8 mm 15/64"
- x1

S1 1:1

**2**

- x2
- x2 5,8 mm 15/64"
- x2

S1 1:1

**8**

- x1
- x1
- x2 5,8 mm 15/64"
- x2

S1 1:1

**3**

- x2
- x1
- x1 19 mm 3/4"
- x1

B2 1:1

**9**

- x1 5,8 mm 15/64"
- x1

S1 1:1

**4**

- x2
- x2 9,5 mm 3/8"
- x2

S2 1:1

**10**

- x1 5,8 mm 15/64"
- x1

S1 1:1

**5** 3+4+

- x1 5,8 mm 15/64"
- x1

S1 1:1

**11**

- x1
- x1
- x1
- x1 19 mm 3/4"
- x1

B2 1:1

**6** 4+5+

- x1 5,8 mm 15/64"
- x1

S1 1:1

**12** 10+11+

- x1 5,8 mm 15/64"
- x1

S1 1:1

**13**

- x2
- x3
- x1 28 mm 1 1/8"
- x1 5,8 mm 15/64"
- x1

S6 1:1

**GB.** Remove all packaging before use. Retain this information, addresses and phone numbers for future reference. Content may vary from pictures. **F.** Retirer tout l'emballage avant utilisation. Conservez les informations, adresses et numéros de téléphone pour consultation ultérieure. Le contenu peut différer des images. **E.** Retire todo el embalaje antes de utilizar el producto. Conserve toda la información, las direcciones y los números de teléfono para futuras referencias. El contenido del paquete puede no corresponder con las imágenes. **D.** Entfernen Sie vor der Benutzung sämtliche Verpackungsmaterialien. Alle Informationen, Adressen und Telefonnummern bitte für mögliche Rückfragen aufbewahren. Der Packungsinhalt kann von den Bildern abweichen. **NL.** Verwijder de verpakking voor gebruik. Bewaar deze informatie, adressen en telefoonnummers voor toekomstig gebruik. Inhoud kan afwijken van illustraties. **I.** Rimuovere l'imballo prima dell'uso. Conservare informazioni, indirizzi e numeri di telefono per riferimento futuro. Il prodotto potrebbe essere differente dalle immagini. **P.** Remova totalmente a embalagem antes de utilizar. Guarde todos os endereços, números de telefone e demais informações para consulta e referência. O conteúdo poderá ser diferente das ilustrações. **R.** Снимите все упаковочные материалы перед использованием. Запишите указанные на упаковке адреса и номера телефонов, чтобы у вас была возможность связаться с нами. Содержимое упаковки может отличаться от иллюстрации.

⚠ Warning: CHOKING HAZARD – Small parts.  
 ⚠ Attention ! RISQUE D'ETOUFFEMENT – Contient de petits éléments.  
 ⚠ Advertencia: PELIGRO DE ASFIXIA – Contiene piezas pequeñas  
 No conveniente para niños menores de 3 años.  
 ⚠ Achtung: ERSTICKUNGSGEFAHR – Kleinteile.  
 ⚠ Waarschuwing: VERSTIKKINGSGEVAAR – Kleine onderdelen.  
 ⚠ Attenzione: RISCHIO DI SOFFOCAMENTO – Pezzi piccoli.  
 ⚠ Aviso: PERIGO DE ASFIXIA – Peças pequenas.  
 ⚠ Осторожно! ОПАСНОСТЬ УДУШЬЯ – Мелкие детали.

UK – 0800 206 1191, [SERVICEUK@SPINMASTER.COM](mailto:SERVICEUK@SPINMASTER.COM)  
 FRANCE – 0800 909 150, [SERVICEFR@SPINMASTER.COM](mailto:SERVICEFR@SPINMASTER.COM)  
 ESPAÑA – [SERVICIO@SPINMASTER.COM](mailto:SERVICIO@SPINMASTER.COM)  
 DEUTSCHLAND – 0800 0101 0222, [KUNDENSERVICE@SPINMASTER.COM](mailto:KUNDENSERVICE@SPINMASTER.COM)  
 SCHWEIZ – 0800 561 350 • ÖSTERREICH – 0800 29 72 67  
 NEDERLAND – 0800 022 36 83, [KLANTENSERVICE@SPINMASTER.COM](mailto:KLANTENSERVICE@SPINMASTER.COM)  
 BELGIË/BELGIQUE – 0800 77 688 • LUXEMBOURG – 800 28 044  
 ITALIA – 800 788 532, [SERVIZIO@SPINMASTER.COM](mailto:SERVIZIO@SPINMASTER.COM)  
 MEXICO – 53.51.44.00  
[WWW.SPINMASTER.COM](http://WWW.SPINMASTER.COM)  
 NORTH AMERICA: 1-800-622-8339 [customer@spinmaster.com](mailto:customer@spinmaster.com)  
 AMÉRIQUE DU NORD:

TM & © 2015 MECCANO for packaging, instructions and models built with this set. TM & © 2015 MECCANO pour l'emballage, les notices et modèles de ce coffret. © MECCANO is an exclusive trademark of MECCANO. Spin Master logo is a trademark of Spin Master Ltd. © MECCANO est une marque de commerce exclusive de MECCANO. Le logo de Spin Master est une marque de commerce de Spin Master Ltd. All rights reserved. Tous droits réservés.  
 SPIN MASTER LTD., 450 FRONT STREET WEST, TORONTO, ON M5V 1B6 CANADA.  
 Imported into EU by SPIN MASTER INTERNATIONAL, S.A.R.L., 16 AVENUE PASTEUR, L-2310, LUXEMBOURG.  
[www.spinmaster.com](http://www.spinmaster.com)  
 Made in France / Fabriqué en France / Hecho en Francia  
 Meccano: 363, avenue de Saint-Exupéry 62100 Calais - France  
 T91784\_0002\_20070934\_GML\_IS\_R1\_MEC\_3 Models Set\_FR