

16209

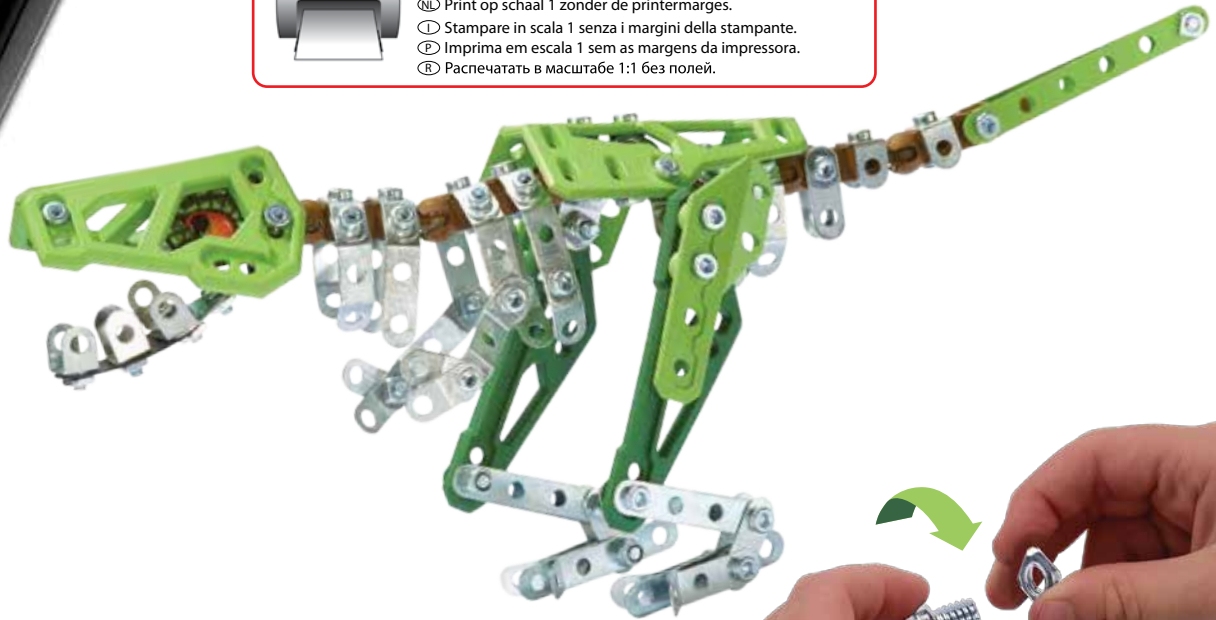

- Ⓞ Please print at scale 1 without the printer margins.
- ⓕ Merci d'imprimer à l'échelle 1 sans les marges de l'imprimante.
- ⓔ Imprimir a escala 1 sin márgenes de impresión.
- ⓓ Maßstab 1 bitte randlos drucken.
- Ⓝ Print op schaal 1 zonder de printermarges.
- Ⓛ Stampare in scala 1 senza i margini della stampante.
- Ⓟ Imprima em escala 1 sem as margens da impressora.
- Ⓡ Распечатать в масштабе 1:1 без полей.



Instructions
Notice de montage
Instrucciones de construcción
Bauanleitung

Bouwinstructie
Istruzioni
Instruções
Инструкции





CONSTRUCTION TIPS / ASTUCES DE CONSTRUCTION
TIPS DE CONSTRUCCIÓN / TIPPS ZUM BAUEN
MONTAGETIPS / SUGGERIMENTI PER COSTRUIRE
DICAS DE MONTAGEM / РЕКОМЕНДАЦИИ ПО СБОРКЕ

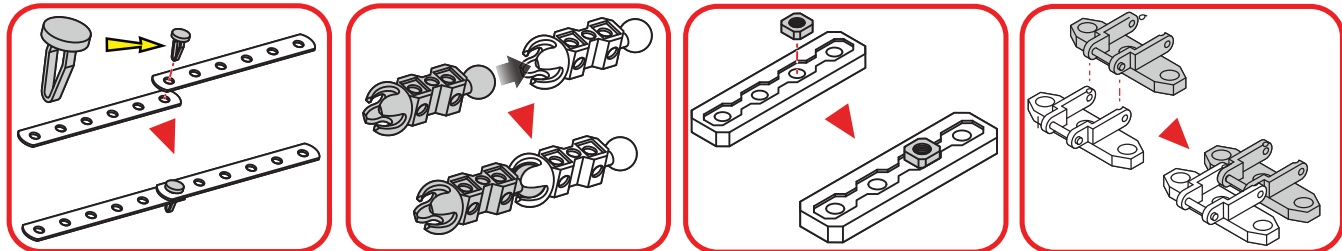
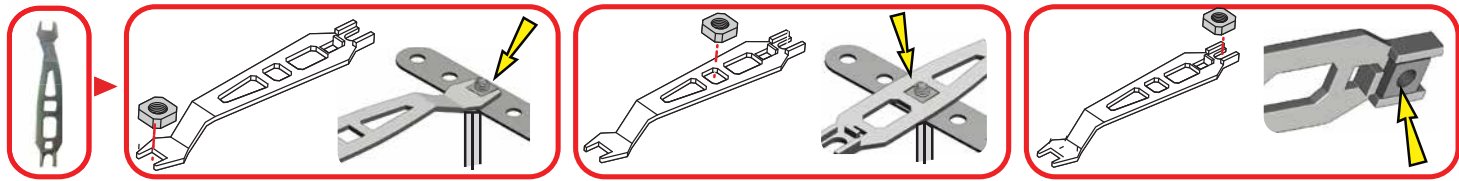
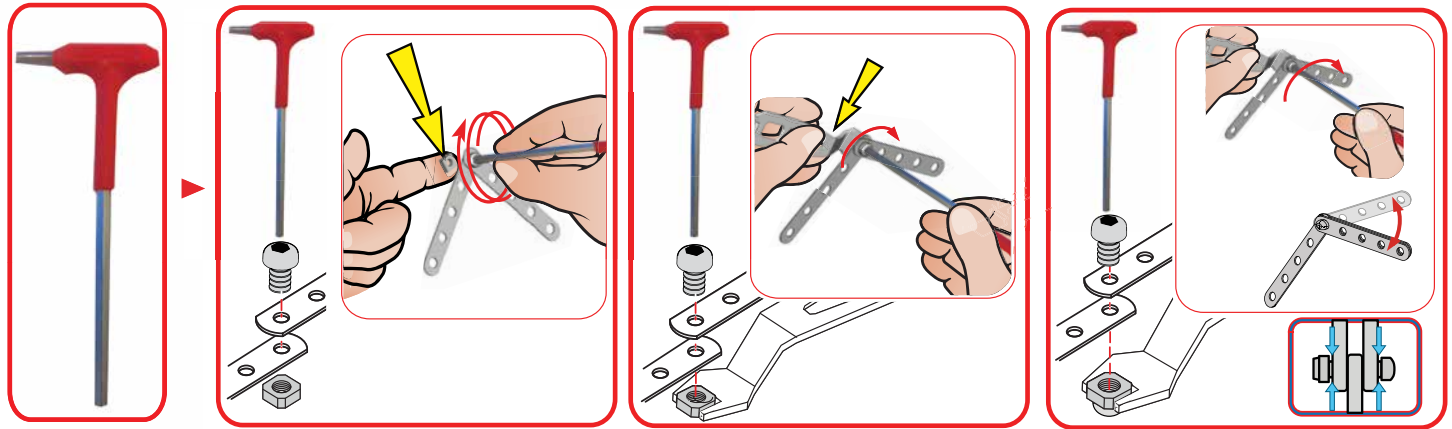

TABLE OF CONTENTS/SOMMAIRE

ÍNDICE / INHALTSVERZEICHNIS / INHOUD / INDICE / ÍNDICE / СОДЕРЖАНИЕ



4



14



23

AVAILABLE ONLINE / DISPONIBLES EN LIGNE
DISPONIBLES EN LÍNEA / ONLINE VERFÜGBAR /
ONLINE VERKRIJGBAAR / DISPONIBILI ONLINE /
DISPONÍVEL ONLINE / ДОСТУПНЫ В
ОНЛАЙН-МАГАЗИНЕ







GB. Content : 179 parts, 2 real tools and 1 instruction sheet for 3 models.
F. Contenu : 179 pièces, 2 vrais outils et 1 notice de montage pour 3 modèles.
E. Contenido : 179 piezas, 2 herramientas reales y 1 guía de instrucciones para 3 modelos.
D. Inhalt: 179 Teile, 2 echte Werkzeuge und 1 Bauanleitung für 3 Modelle.
NL. Inhoud : 179 onderdelen, 2 stuks gereedschap en 1 bouwstructie voor 3 modellen.
I. Contenuto : 179 pezzi, 2 attrezzi e 1 guida per l'uso per 3 modelli.
P. Conteúdo: 179 peças, 2 ferramentas reais e 1 folha de instruções para 3 modelos.
R. В коробке: 179 деталей, 2 настоящих инструмента и 1 инструкция по сборке 3 моделей.

GB. Building instructions for the 7 other models are available at www.meccano.com.
F. Les notices de montage des 7 autres modèles sont disponibles sur www.meccano.com.
E. Hay instrucciones de construcción disponibles para los otros 7 modelos en www.meccano.com.
D. Bauanleitungen für die anderen 7 Modelle sind auf www.meccano.com zu finden.
NL. Bouwstructies voor de andere 7 modellen zijn beschikbaar op www.meccano.com.
I. Le istruzioni di montaggio degli altri 7 modelli sono disponibili alla pagina www.meccano.com.
P. Instruções de montagem dos restantes 7 modelos disponíveis em www.meccano.com.
R. Инструкции по сборке 7 других моделей можно найти на сайте www.meccano.com.





GB. Only one model can be built at a time. **F.** Les pièces fournies ne permettent de monter qu'un seul modèle à la fois. **E.** Solo es posible construir un modelo a la vez. **D.** Jeweils nur eins der Modelle baubar. **NL.** Er kan maar een model tegelijk worden gebouwd. **I.** Permette di realizzare un solo modello per volta. **P.** Só é possível montar um modelo de cada vez. **R.** Одновременно можно построить только одну модель.



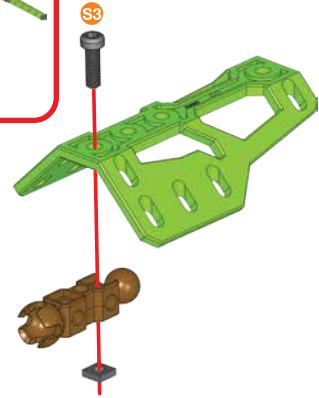
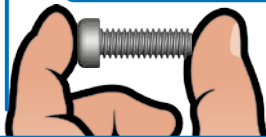



- 1**
-  **x1**
 -  **x1**
 -  **S3** | 12 mm | **x1**
 -  **x1**

-  **S3** | **1:1**

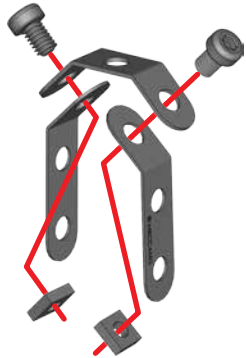



- 2**
-  **x2**
 -  **x1**
 -  **S1** | 5,8 mm | 15/64" | **x2**
 -  **x2**
-  **S1** | **1:1**

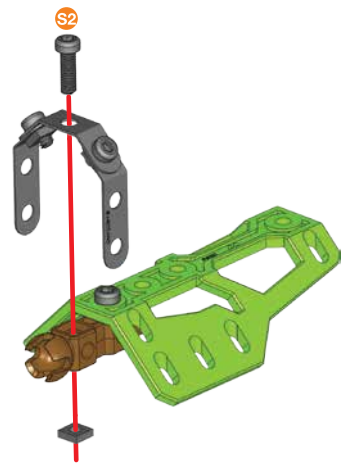

- 3** ①+②+
-  **S3** | 12 mm | 1/2" | **x1**
 -  **x1**
-  **S3** | **1:1**





4

-  **x2**
-  **x2** | 5,8 mm | 15/64"
-  **x2**

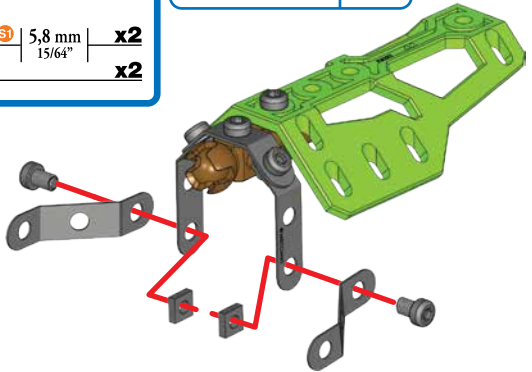
-  **S1** **1:1**





5

-  **x4**
-  **x2** | 5,8 mm | 15/64"
-  **x2**

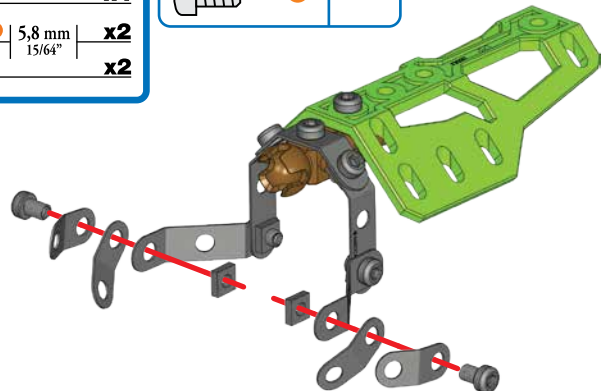
-  **S1** **1:1**





6

-  **x1**
-  **x1** | 5,8 mm | 15/64"
-  **x1**

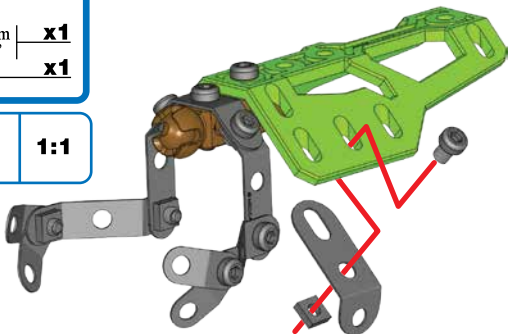
-  **S1** **1:1**



7

-  **x1**
-  **x1** | 5,8 mm | 15/64"
-  **x1**

-  **S1** **1:1**

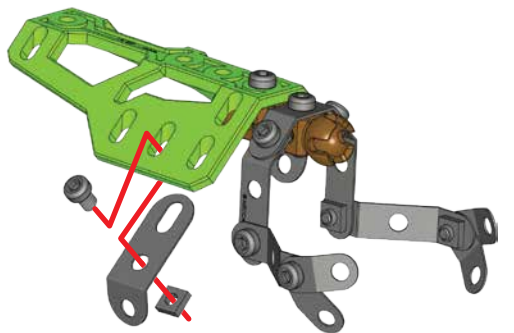

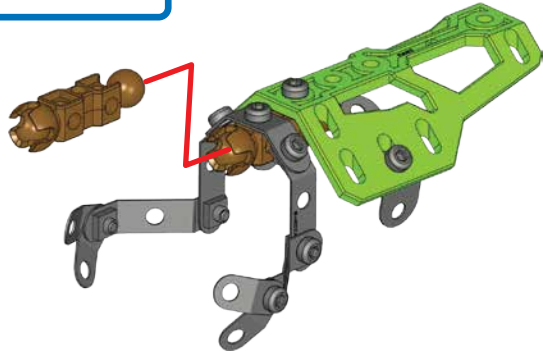

8

 **x1**



9

 **x2**

 **x1**

 **S1** | 5,8 mm | 15/64" | **x2**

 **x2**

 **S1** **1:1**

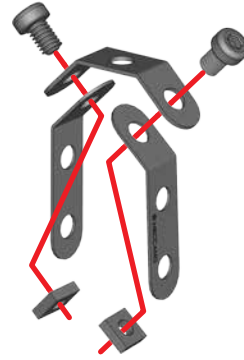

10 **8 + 9 +**

 **S3** | 12 mm | 1/2" | **x1**

 **x1**

 **S3** **1:1**

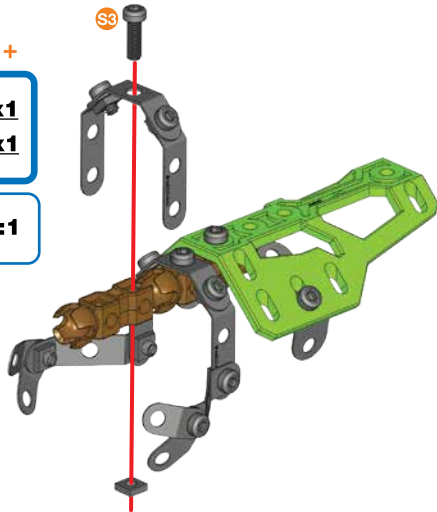

11

 **x3**



 **S1** | 5,8 mm | 15/64" | **x2**

 **x2**

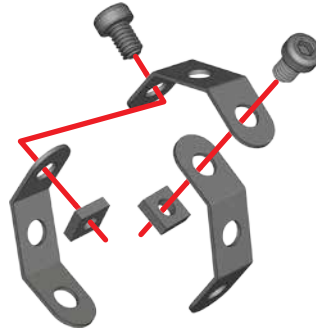
 **S1** **1:1**



12 (10) + (11) +

	12 mm 1/2"	x1
		x1

	1:1
---	------------

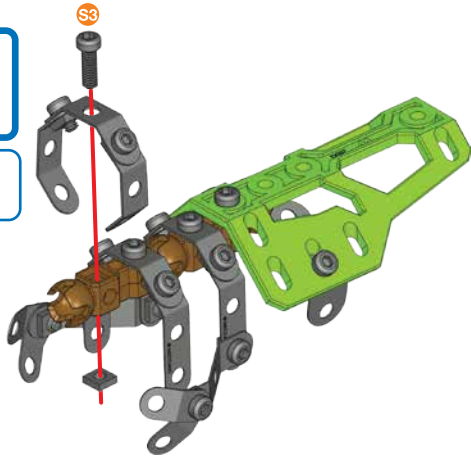





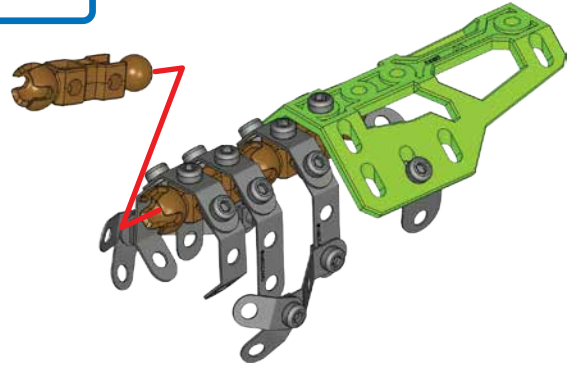

13

	x1
--	-----------





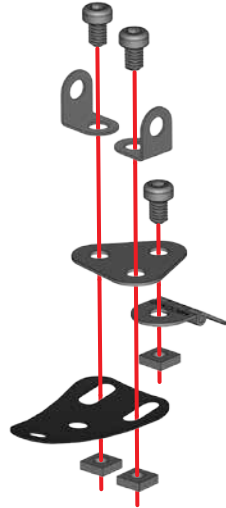

14

	x1	
	x1	
	x1	
	x2	
	5,8 mm 15/64"	x3
	x3	

	1:1
---	------------





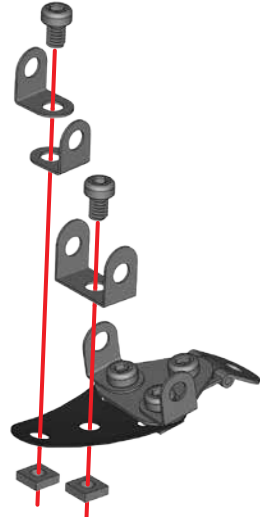

15

	x1	
	x2	
	5,8 mm 15/64"	x2
	x2	



	1:1
--	------------

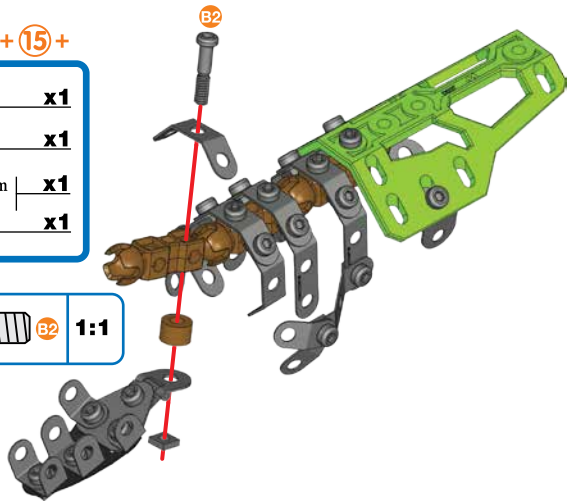

- 16** 13 + 15 +
-  **x1**
 -  **x1**
 -  19 mm **x1**
3/4"
 -  **x1**

-  **S2** **1:1**



- 17**
-  **x1**
 -  **x1**
 -  9,5 mm **x1**
3/8"
 -  **x1**

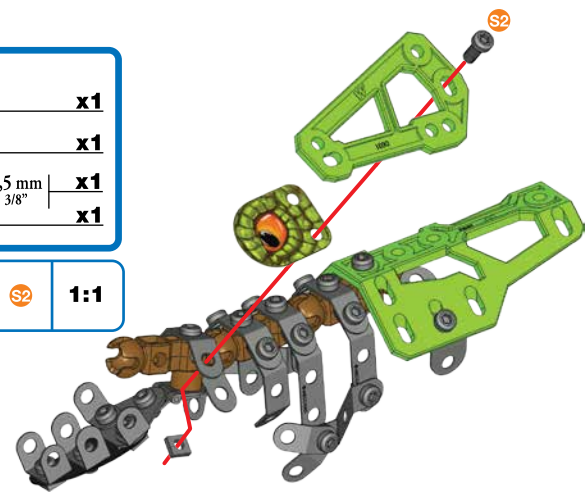

-  **S2** **1:1**

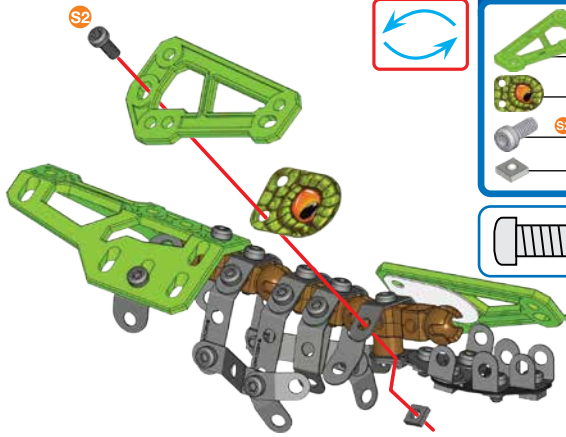
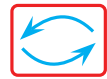

- 18**
-  **x1**
 -  **x1**
 -  9,5 mm **x1**
3/8"
 -  **x1**

-  **S2** **1:1**



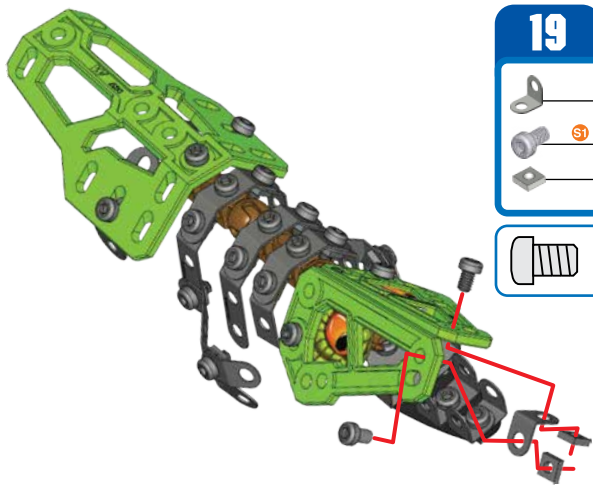

- 19**
-  **x1**
 -  5,8 mm **x2**
15/64"
 -  **x2**

-  **S1** **1:1**



20

-  x1
-  12 mm | 1/2" x1
-  x1

-  S3 1:1

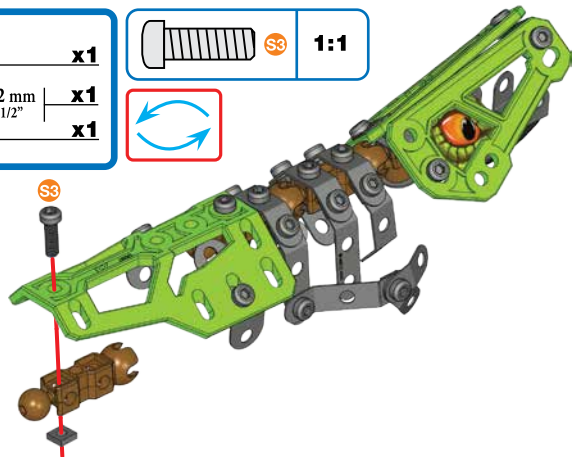

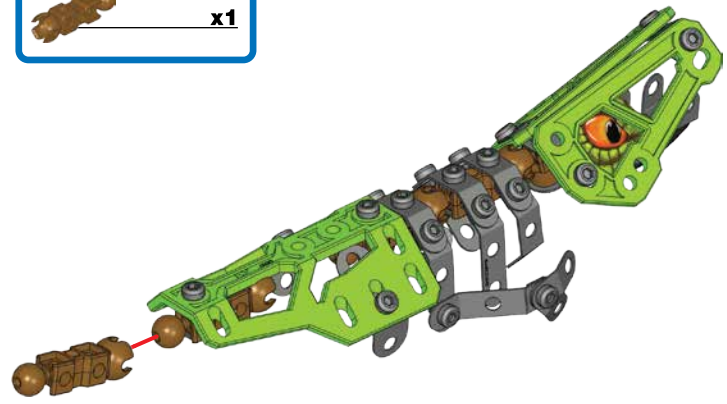

21

-  x1



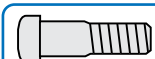

22

-  x2
-  14,7 mm | 37/64" x1
-  x1

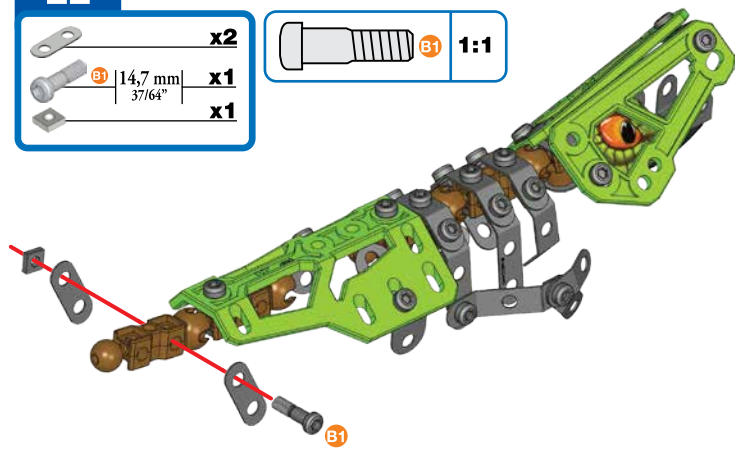
-  B1 1:1



23

-  x1
-  12 mm | 1/2" x1
-  x1

-  S3 1:1

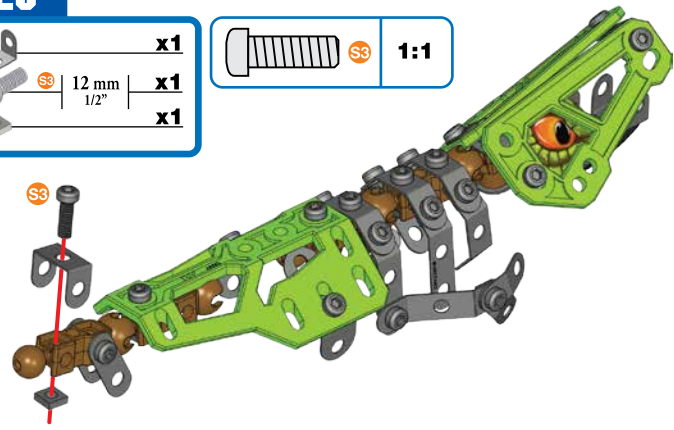

24



x1

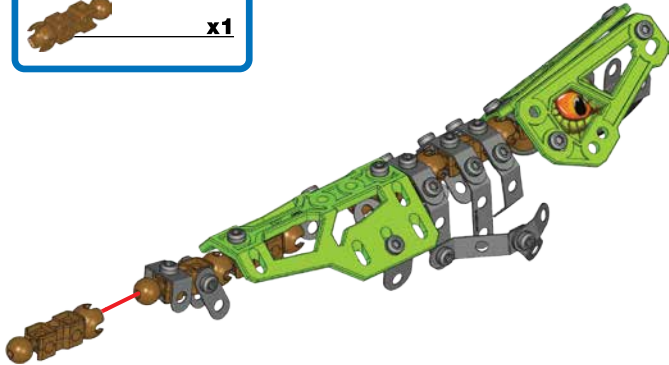

25



x2



x2



x1



x1

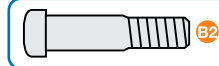

1:1

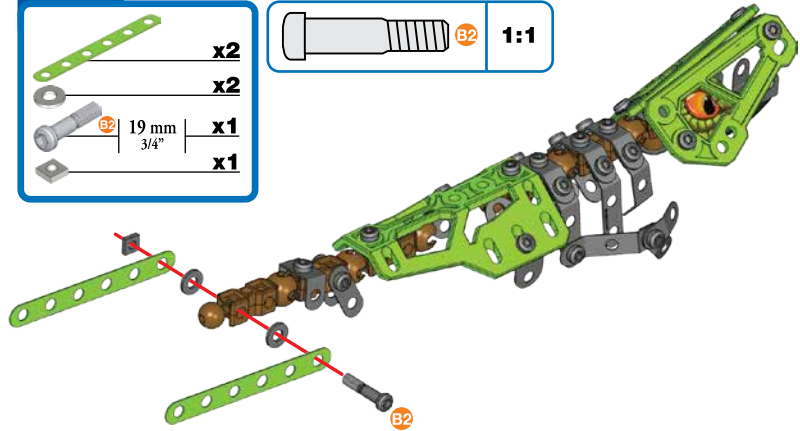

26



5,8 mm
15/64\"/>

x1



x1



1:1

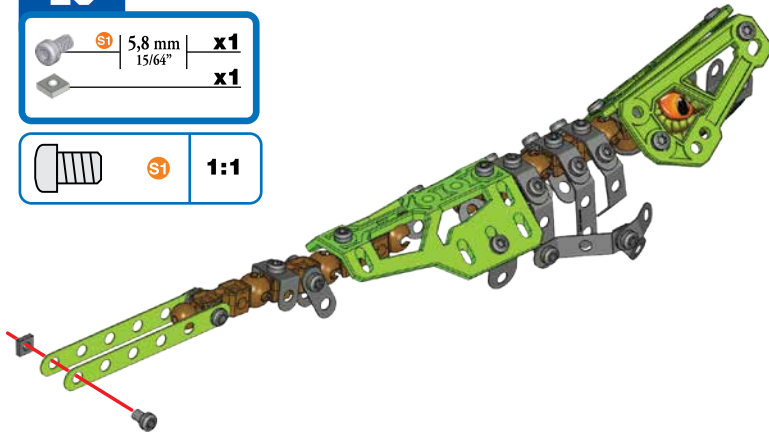

27



x1



x2



x2



x1



x1



14,7 mm
37/64\"/>

x1



x1

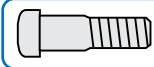

1:1

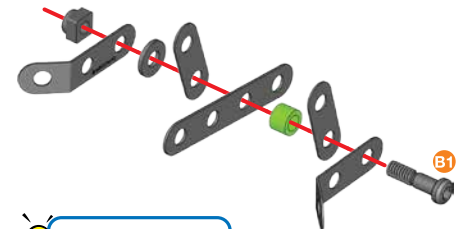
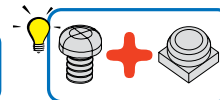

28

	x2
	x1
	x1
	x1

	1:1
--	------------

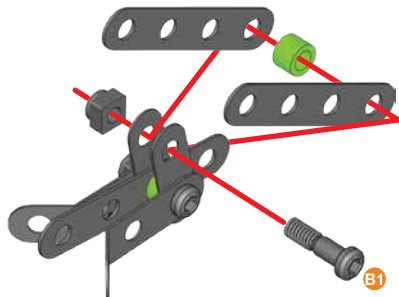
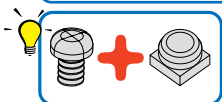
**29**

	x1
	x1
	x1

	1:1
--	------------

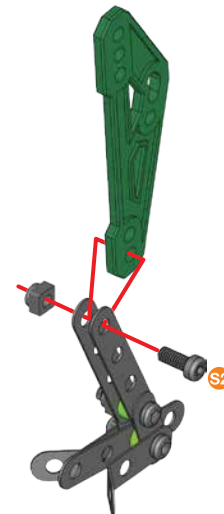
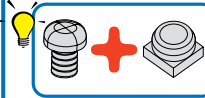
**30**

	x1
	x1
	x1
	x1

	1:1
--	------------

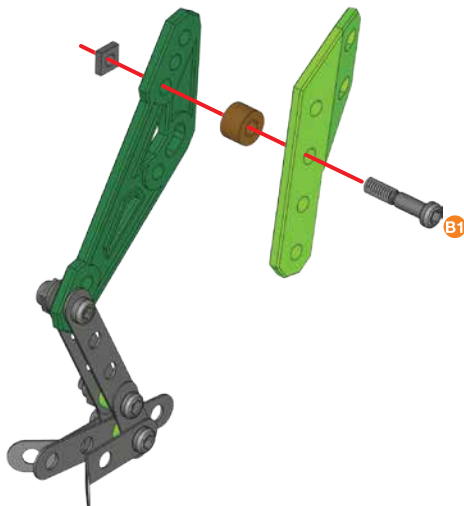

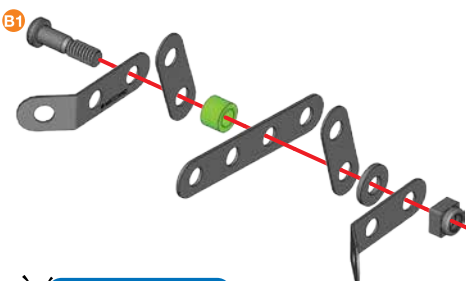
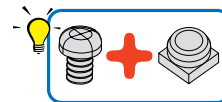

**31**

	x1
	x2
	x2
	x1
	x1
	x1
	x1

	1:1
--	------------



32

-  **x2**
-  **x1**
-  **x1**
-  **x1**



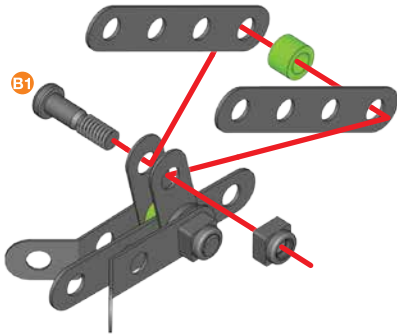
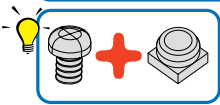

-  **1:1**

**33**

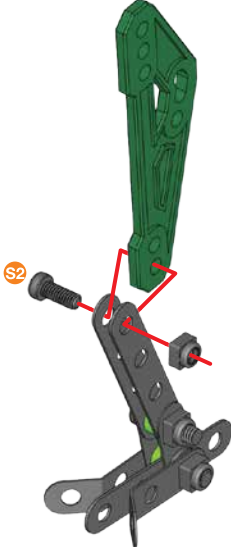
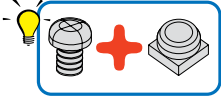
-  **x1**
-  **x1**
-  **x1**

-  **1:1**



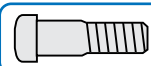

**34**

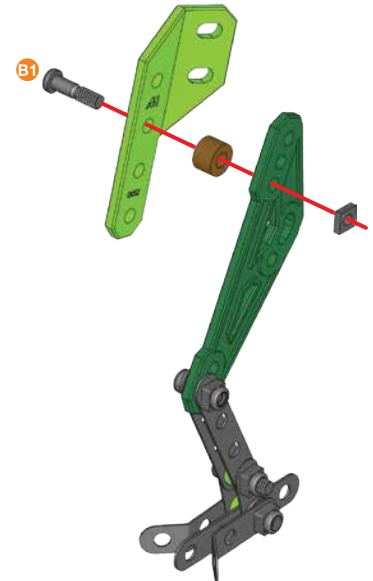
-  **x1**
-  **x1**
-  **x1**
-  **x1**

-  **1:1**





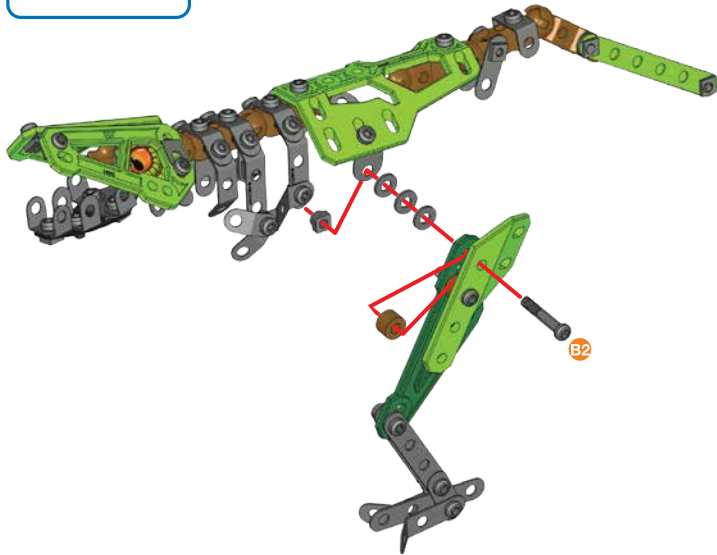
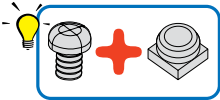

35**26 + 30 +**

	x1
	x3
 23 mm 15/16"	x1
	x1

	1:1
---	------------

**36****34 + 35 +**

	x1
	x3
 23 mm 15/16"	x1
	x1

	1:1
--	------------

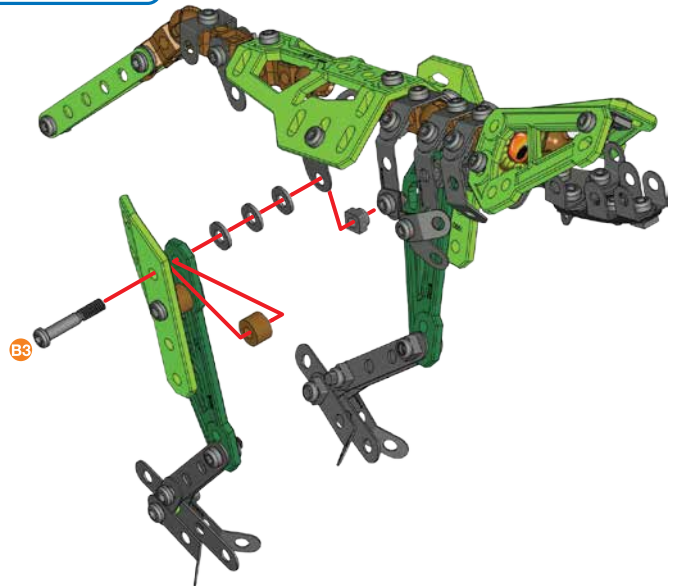
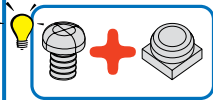

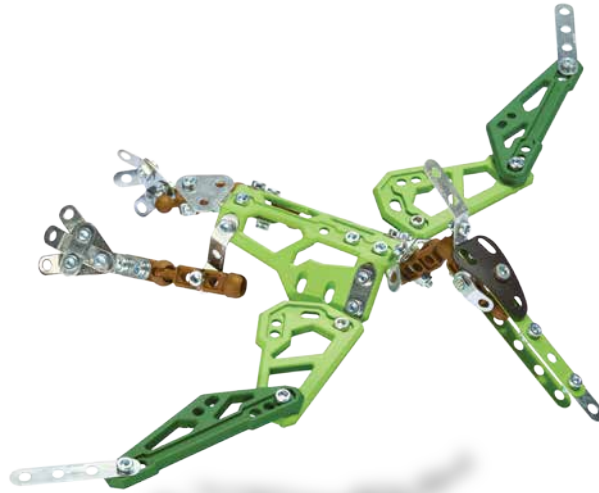

1

	x1		x1
	x1		x4
		5,8 mm 15/64"	x4
			x4

S1 **1:1**

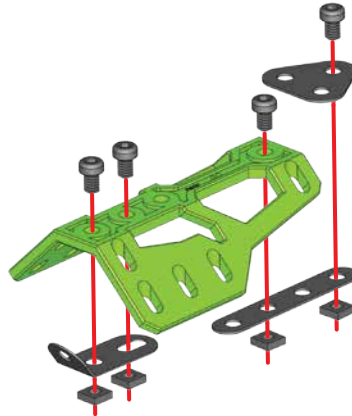

2

	x1
	x1
5,8 mm 15/64"	x1
	x1

S1 **1:1**

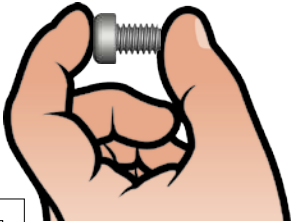
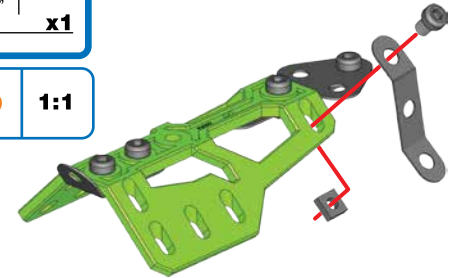

3

	x1
	x1
	x1

	S1	1:1
--	-----------	------------

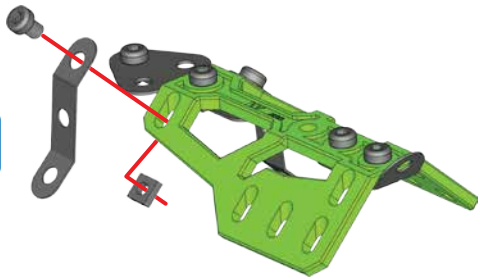

4

	x1
	x2
	x2

	S1	1:1
--	-----------	------------

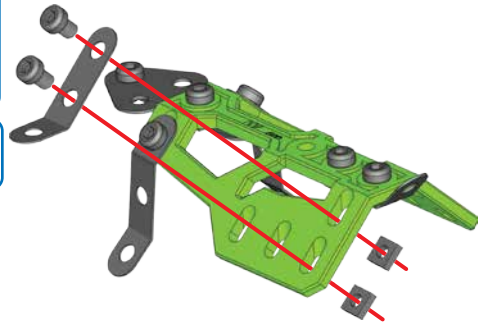

5

	x1
	x2
	x2

	S1	1:1
--	-----------	------------

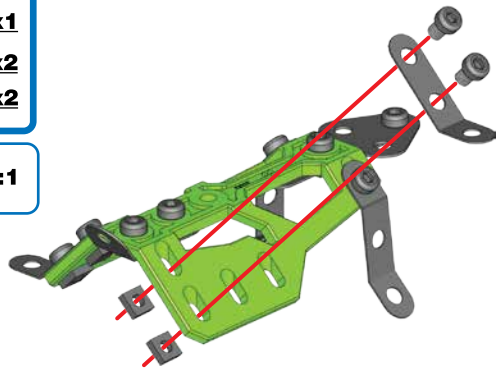

6

	x1
	x1
	x1
	x1
	x1

	S3	1:1
--	-----------	------------

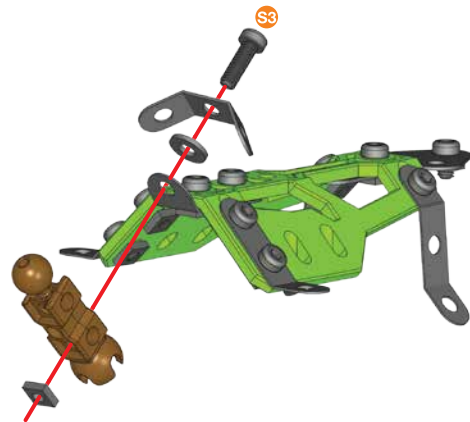

7



x1

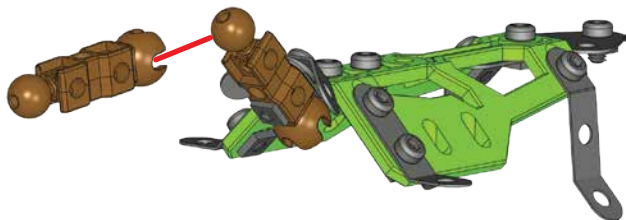

8



x1



x1



S1 5,8 mm
15/64"

x2



x2



S1

1:1

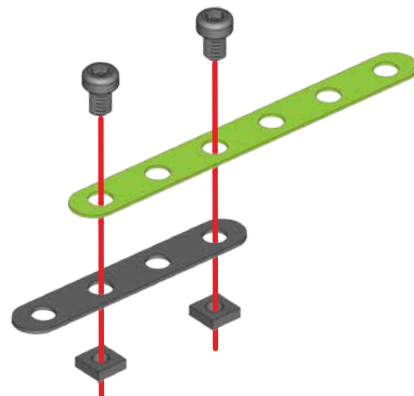

9



x1



x1



S1

14,7 mm
37/64"

x1



x1



S1

1:1

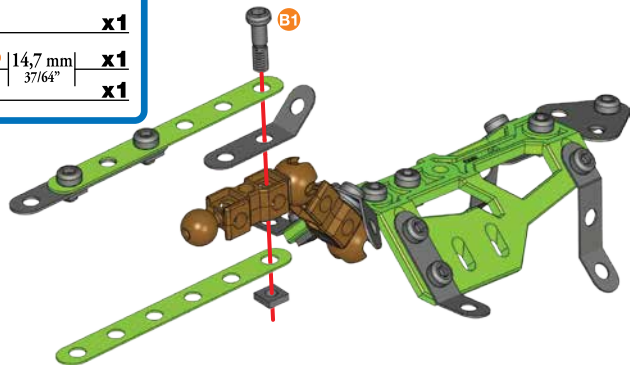

10



x1



S1

5,8 mm
15/64"

x1







x1

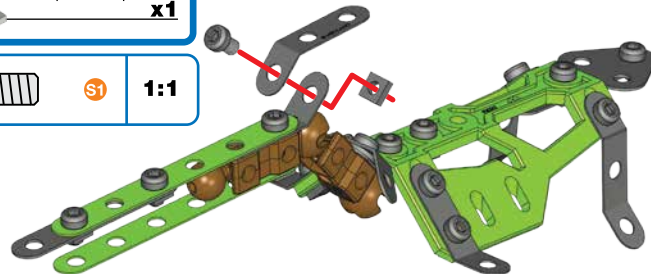

S1



1:1



- 11**
-  **x1**
 -  **x1**
 -  **B2** | 19 mm | **x1**
3/4"
 -  **x1**

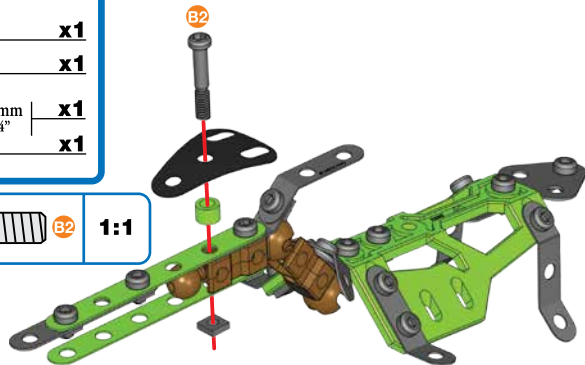

-  **B2** | **1:1**

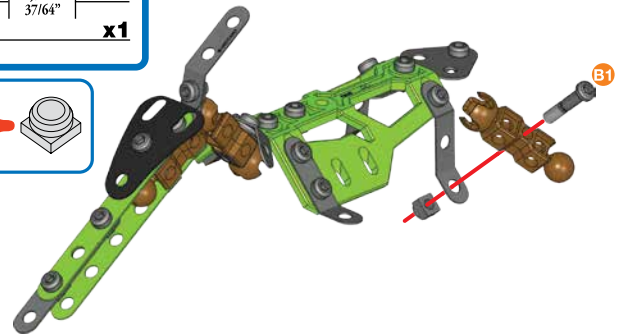
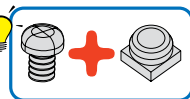

- 12**
-  **x1**
 -  **B1** | 14,7 mm | **x1**
37/64"
 -  **x1**

-  **B1** | **1:1**



- 13**
-  **x1**
 -  **B1** | 14,7 mm | **x1**
37/64"
 -  **x1**



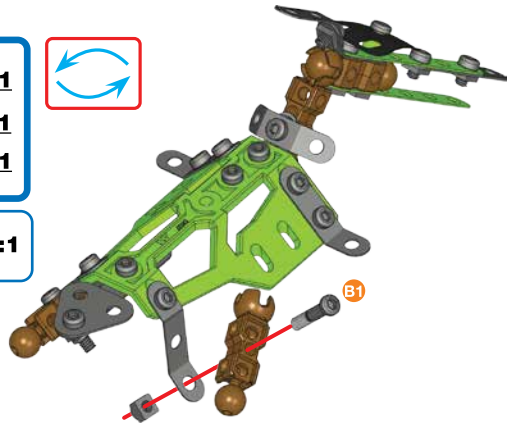
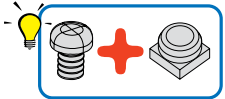

-  **B1** | **1:1**

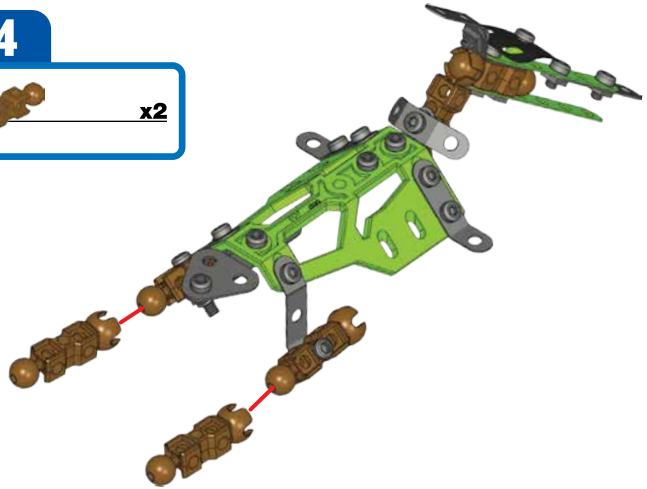

- 14**
-  **x2**





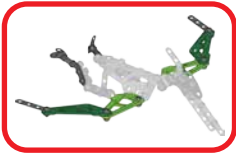

15

	x2
 5,8 mm 15/64"	x1
	x1

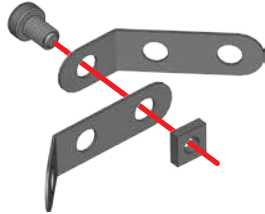



	S1	1:1
---	-----------	------------

**16**

	x2
 5,8 mm 15/64"	x1
	x1

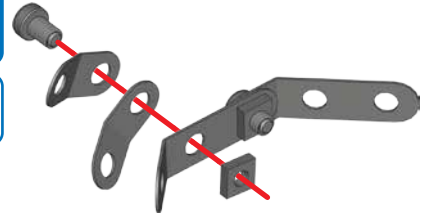

	S1	1:1
--	-----------	------------

**17****(14) + (16) +**

 12 mm 1/2"	x2
	x2

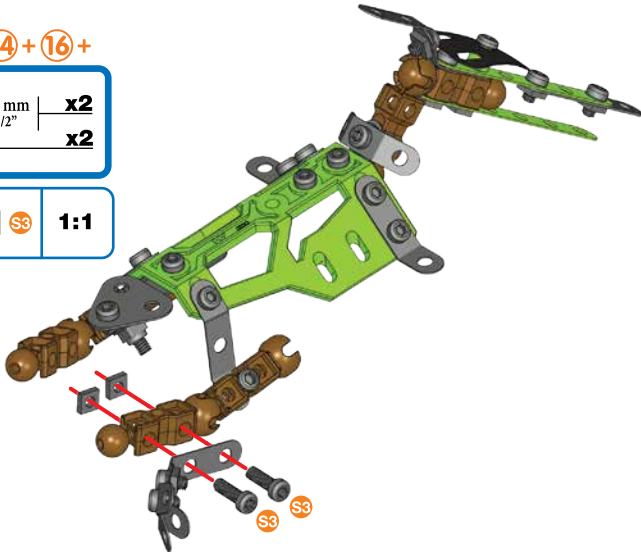
	S3	1:1
---	-----------	------------



**18**

	x2
 5,8 mm 15/64"	x1
	x1

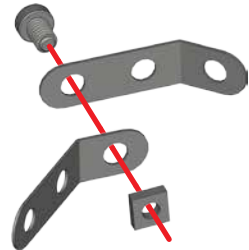
	S1	1:1
--	-----------	------------



19

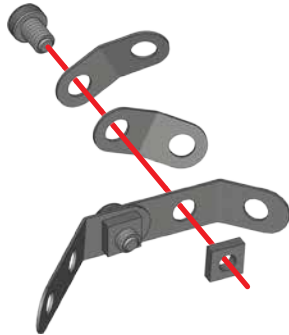

	x2
 5,8 mm 15/64"	x1
	x1

	1:1
---	------------



20



17 + 19 +

 12 mm 1/2"	x2
	x2

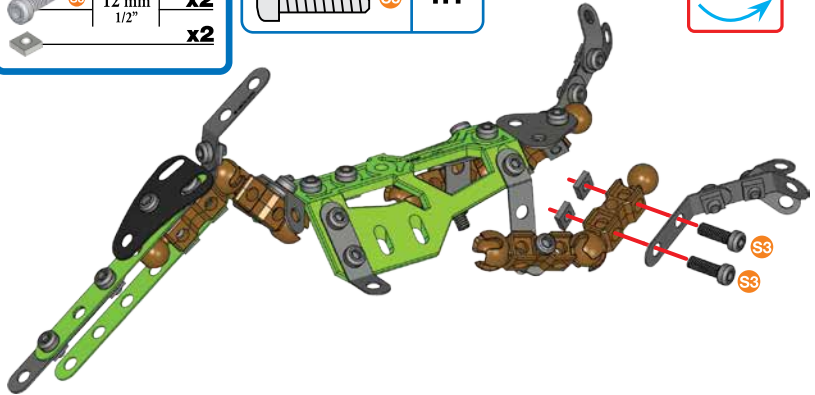
	1:1
---	------------



21

	x1
 9,5 mm 3/8"	x1
	x1

	1:1
---	------------

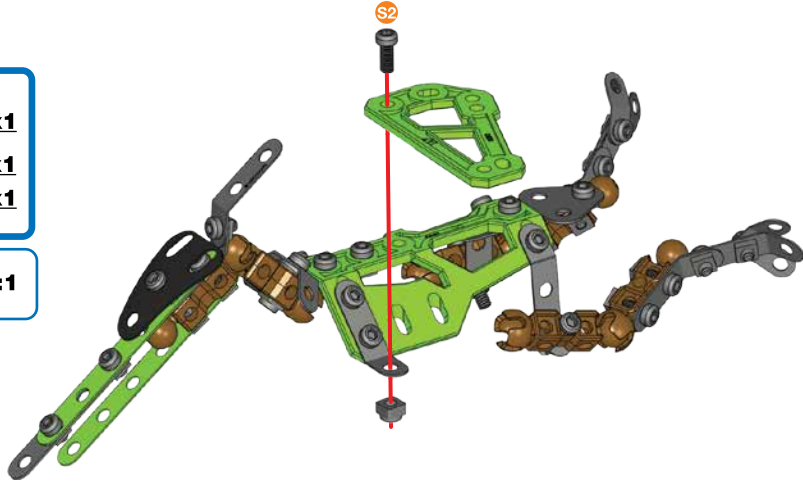
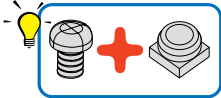

22



x1

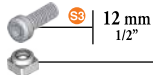

12 mm

x1

1/2"

x1



1:1

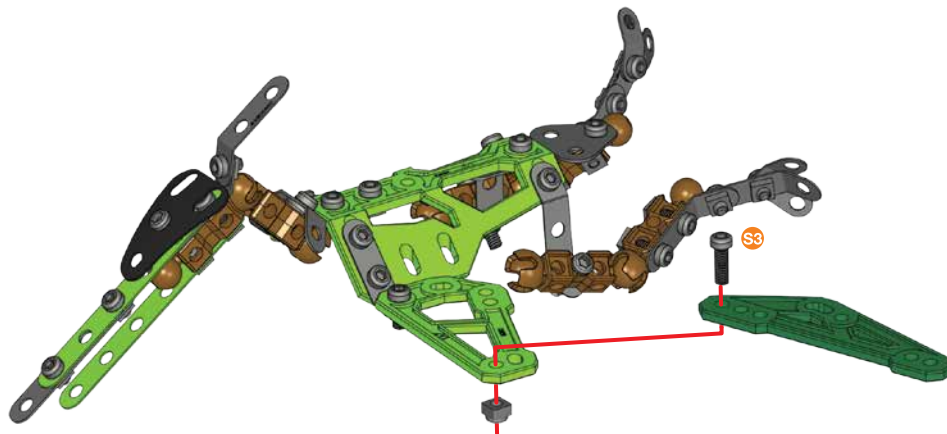

23



x1



5,8 mm

x2

15/64"

x1



1:1

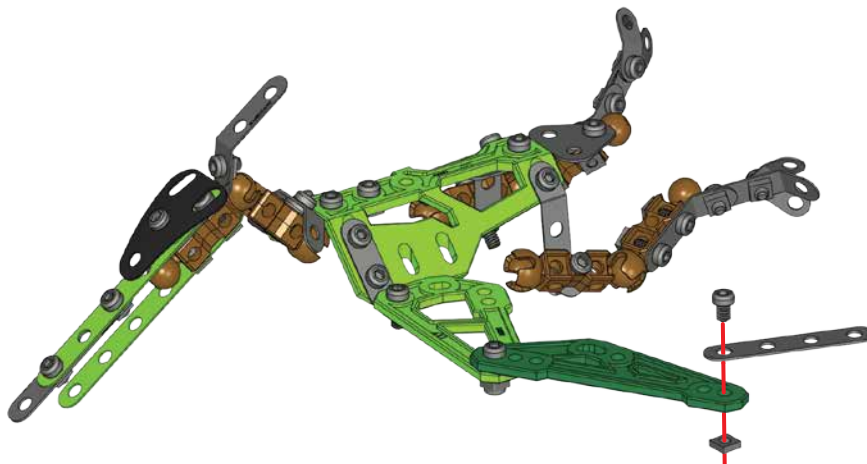

24

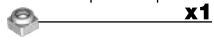
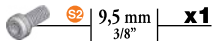

1:1

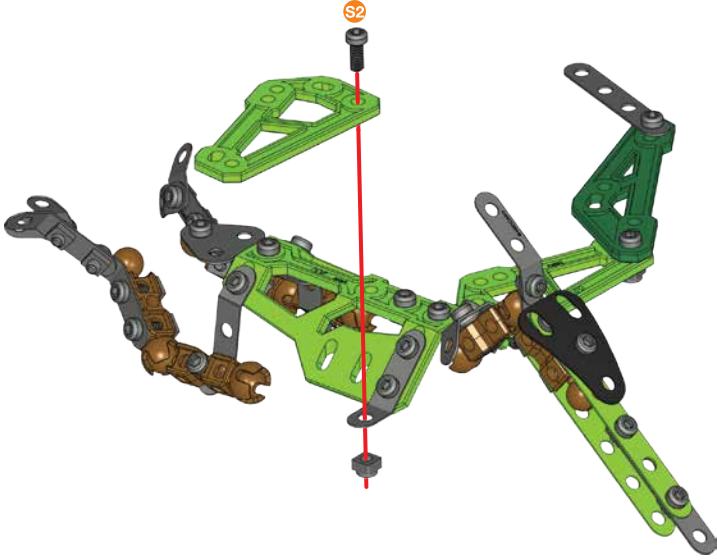
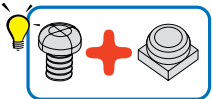

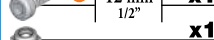

25

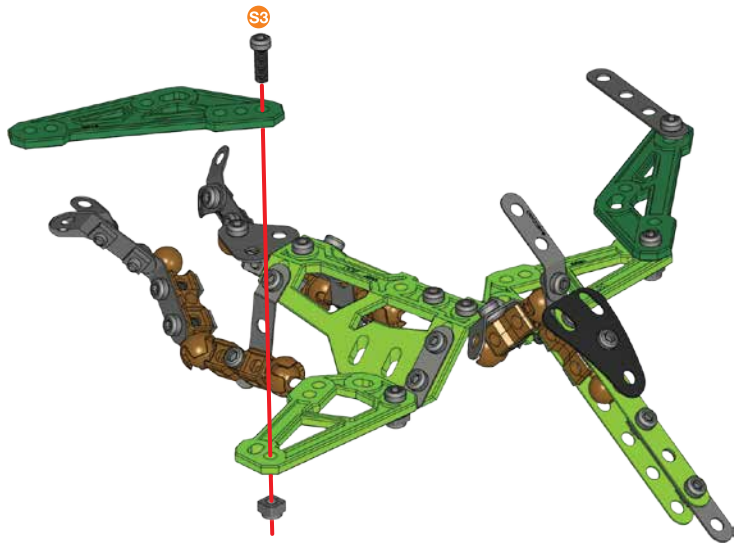
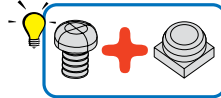

1:1



26



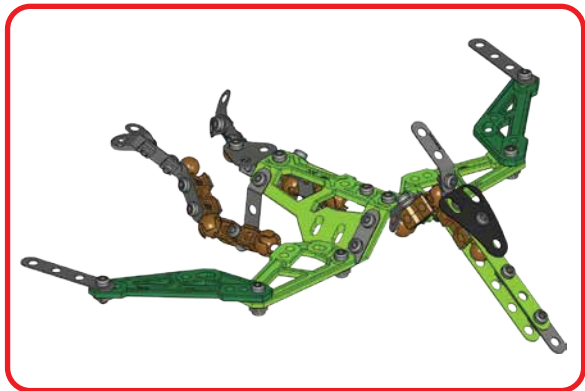
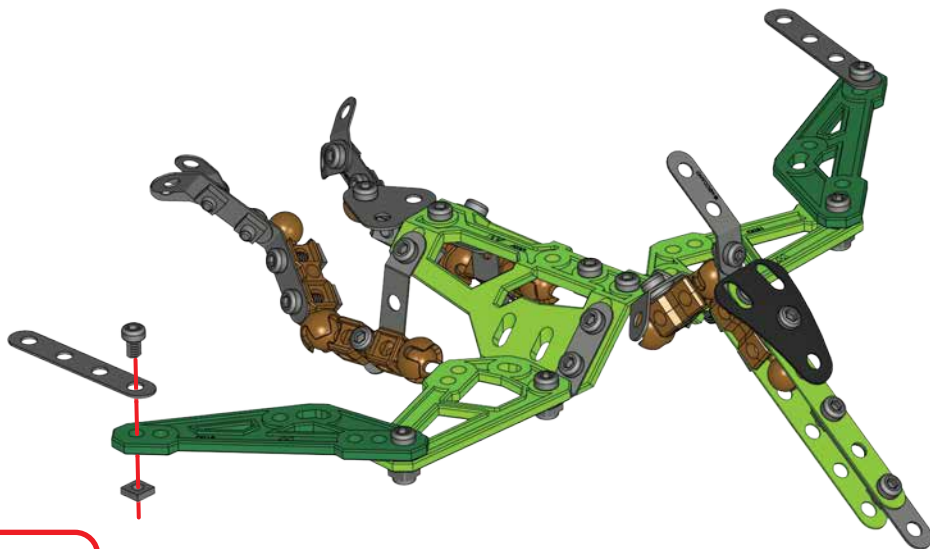

	x1
 5,8 mm 15/64"	x2
	x1

	1:1
---	------------







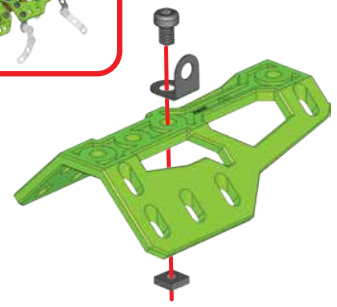

1

-  **x1**
-  **x1**
-  **S1** | 5,8 mm | **x1**
15/64"
-  **x1**



2

-  **x2**
-  **x2**
-  **x4**
-  **B2** | 19 mm | **x2**
3/4"
-  **x2**

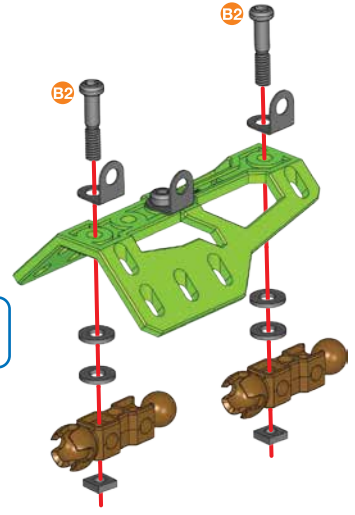
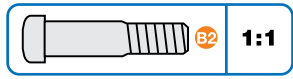

3

	x1
	x1
	x1

	1:1
--	------------

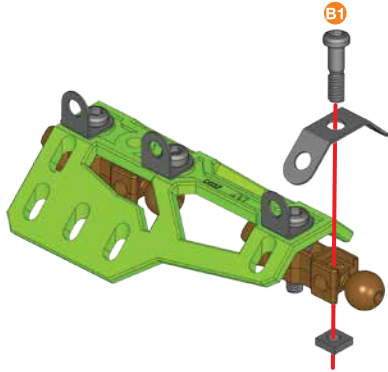

4

	x1
	x1
	x1
	x2
	x2

	1:1
--	------------

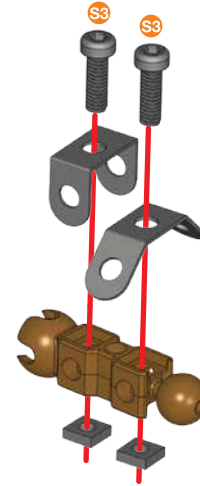

5

	x1
	x1
	x1
	x1

	1:1
--	------------

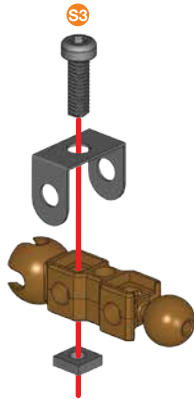

6

(3) + (4) + (5) +

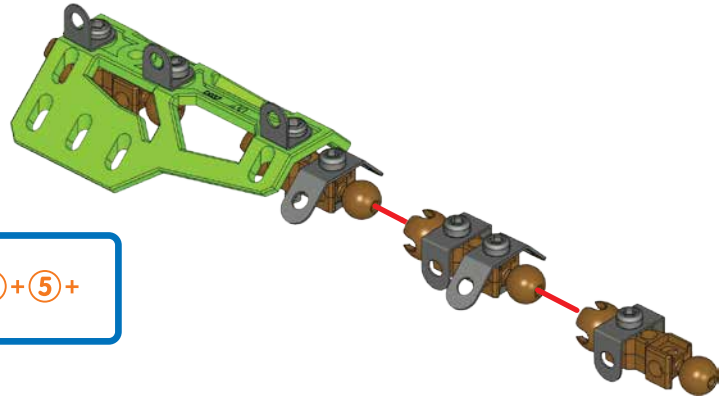

7

	x1
	x1
	x1
14,7 mm 37/64"	x1
	x1

	1:1
--	-----

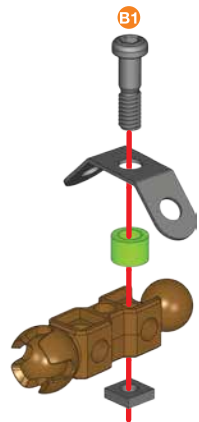

8

	x1
	x1
	x1
12 mm 1/2"	x1
	x1

	1:1
--	-----

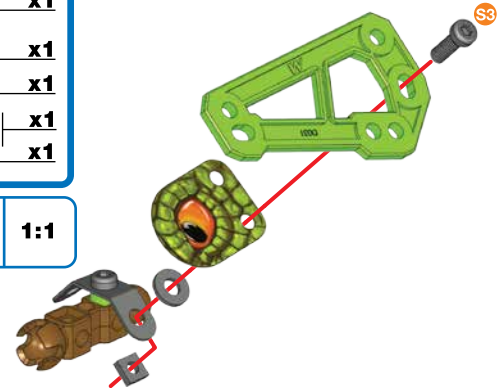

9

	x1
	x1
	x1
12 mm 1/2"	x1
	x1

	1:1
--	-----

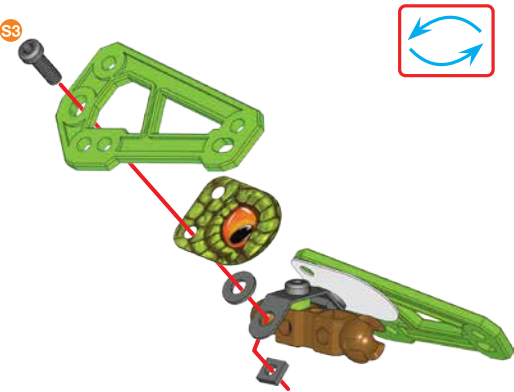

10

⑧ + ⑨ +

	x1
5,8 mm 15/64"	x2
	x2

	1:1
--	-----

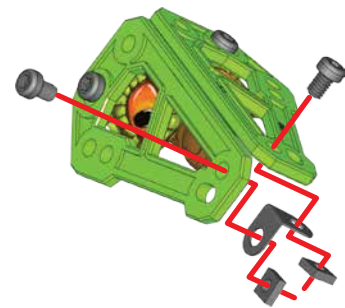

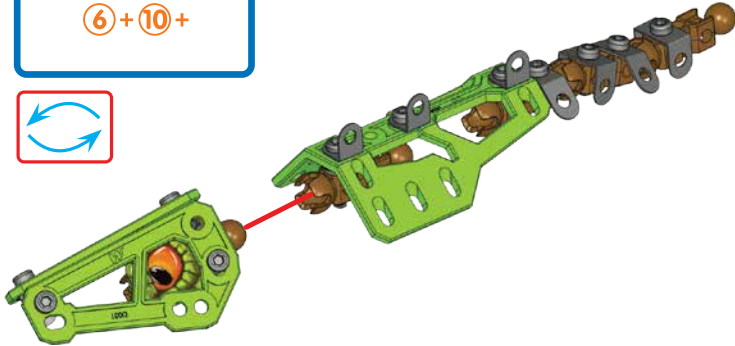
11**6 + 10 +****13**

	x2
	x3
	x3



	1:1
--	------------

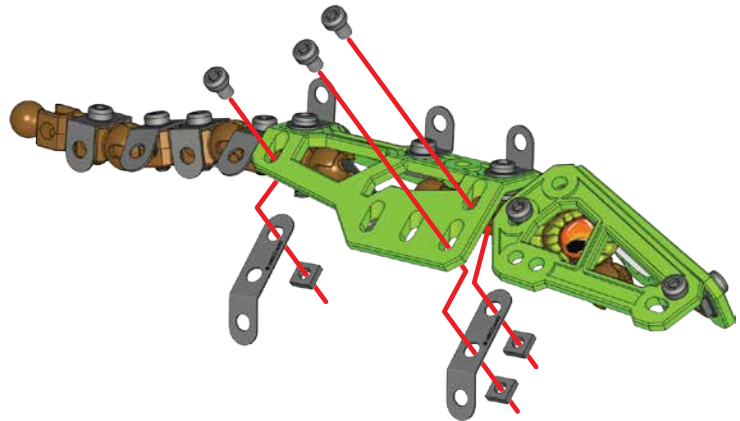

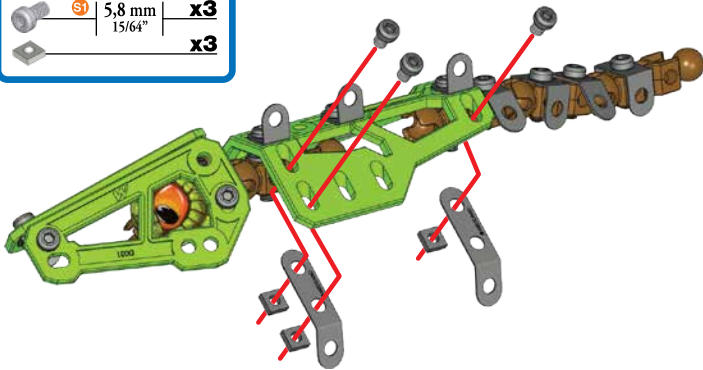

**12**

	x2
	x3
	x3

	1:1
--	------------





14

-  **x1**
-  **x1**
-  **x1**
-  **S3** | 12 mm | **x1**
1/2"
-  **x1**

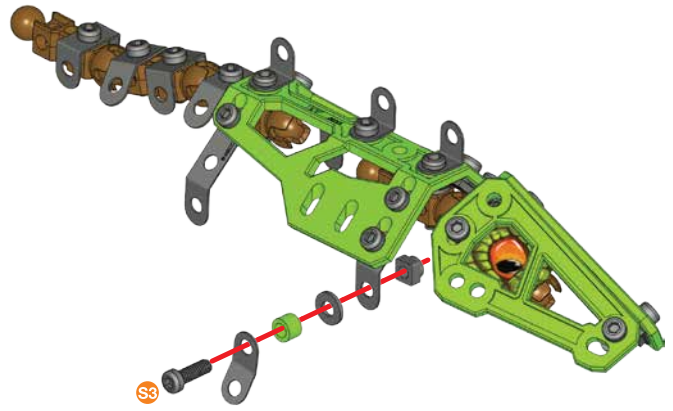
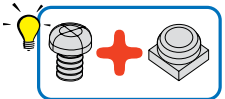
-  **S3** | **1:1**



15

-  **x1**
-  **S1** | 5,8 mm | **x1**
15/64"
-  **x1**

-  **S1** | **1:1**

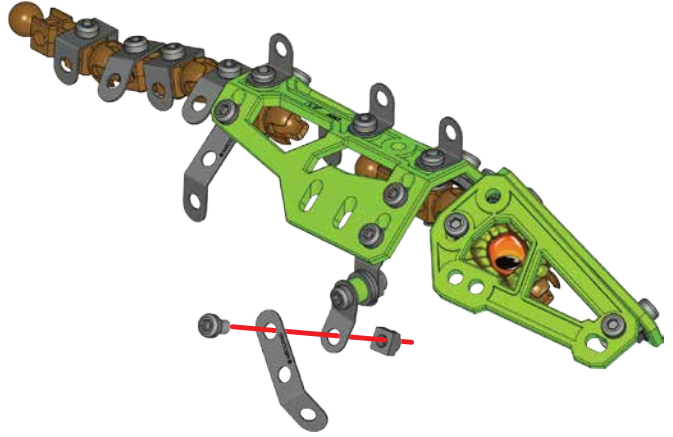
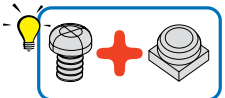

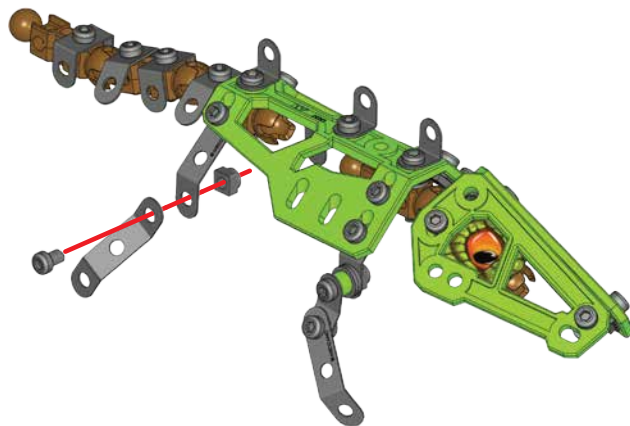
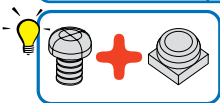
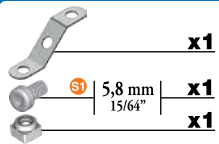
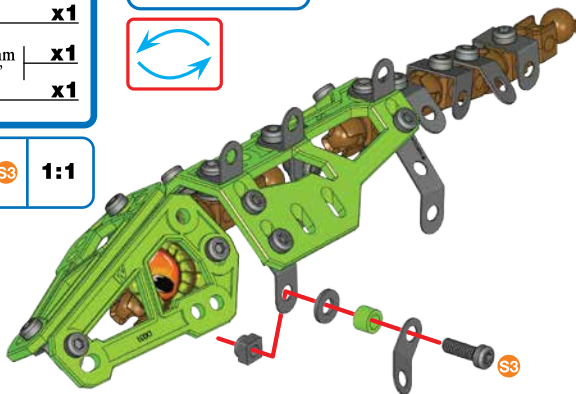
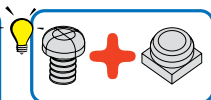
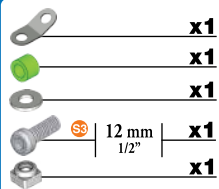
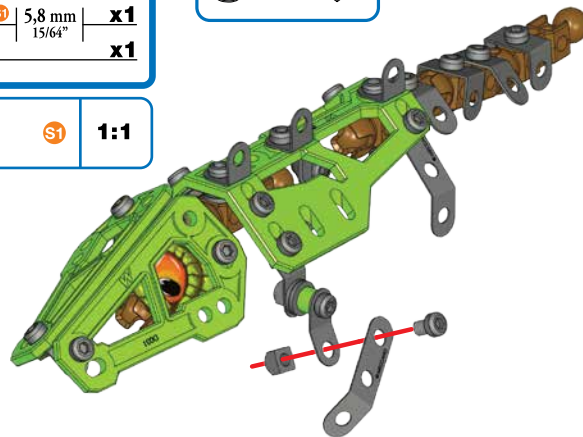
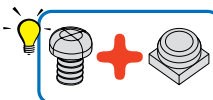
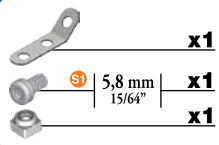
16**17****18**

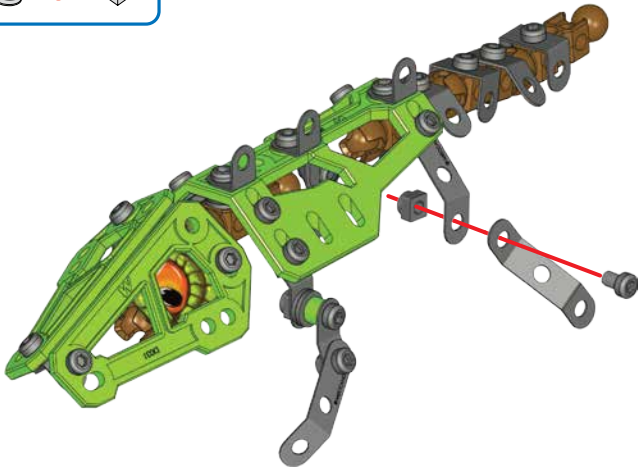
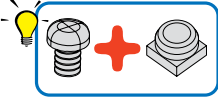
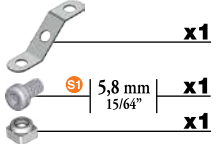
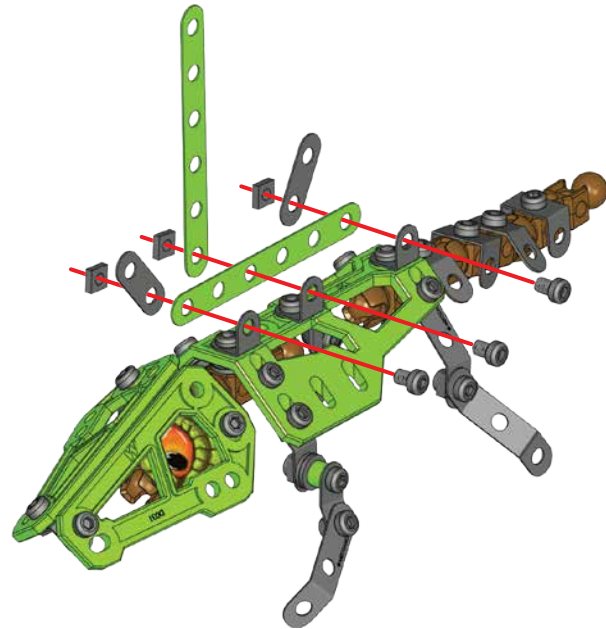
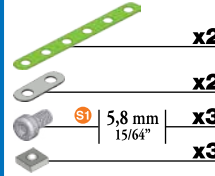
19**20**

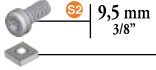
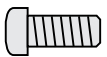
21**x2**9,5 mm
3/8"**x2****x2**

S2

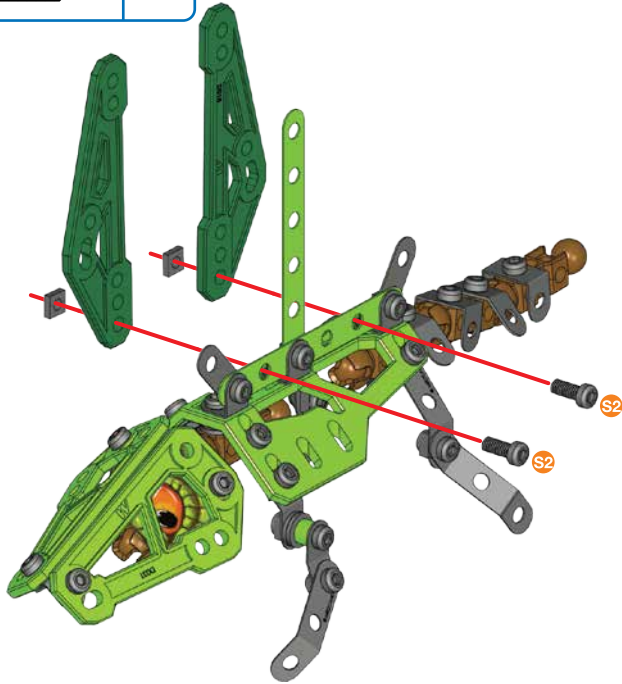
1:1**22****x2**

S3

12 mm

1/2"

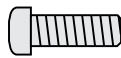
x3**x3**

S3

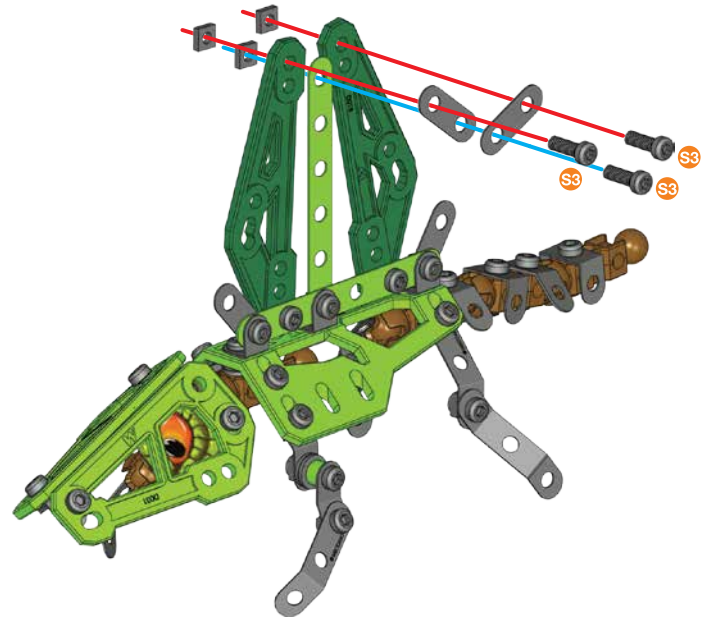
1:1



D037 x1



D051 x1

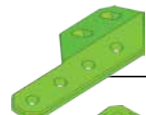

D052 x1



D031 x2



D018 x2



B684 x1



D020 x6



A277 (0077) x1



x1



x1



A413 (0235A) x2



A417 (0235H) x6



A825 (0825) x2



A713 (0012D) x2



A437 (0812D) x8



C331 x6



A811 (0811) x2



C330 x5



A336 (0114) x1



A806 (0806B) x6



C483 x4



B3 23 mm
15/16"

A347 (0147G) x2



B2 19 mm
3/4"

A447 (0147F) x4



B1 14,7 mm
37/64"

A247 (0147D) x8



S3 12 mm
1/2"

A411 (0111A) x12



S2 9,5 mm
3/8"

A511 (0111C) x4



S1 5,8 mm
15/64"

A637 (0037B) x22

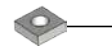

A337 (0037A) x39

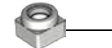

A737 (0037H) x8



A138 (0038) x10



A238 (0038A) x5



A338 (0038B) x4



C995 x1



C993 x1

GB. Remove all packaging before use. Retain this information, addresses and phone numbers for future reference. Content may vary from pictures. Meccano reserves the right to discontinue the website www.meccano.com at any time. An adult should periodically check this toy to ensure no damage or hazards exist, if so, remove from use. Children should be supervised during play.

F. Retirer tout l'emballage avant utilisation. Conserver les informations, adresses et numéros de téléphone pour consultation ultérieure. Le contenu peut différer des images. Meccano se réserve le droit de supprimer le site Internet www.meccano.com à tout moment. Un adulte doit régulièrement examiner ce jouet afin de s'assurer qu'il ne présente pas de dommage ni de risque. En cas de problème, ne plus l'utiliser. Les enfants doivent être surveillés lorsqu'ils jouent.

E. Retire todo el embalaje antes de utilizar el producto. Conserve toda la información, las direcciones y los números de teléfono para futuras referencias. El contenido del paquete puede no corresponder con las imágenes. Meccano se reserva el derecho a suspender el sitio web www.meccano.com en cualquier momento. Un adulto debe revisar de forma periódica el juguete para asegurarse de que no supone un riesgo o peligro para el niño; si así fuera el caso, interrumpa su uso. Supervise a los niños mientras juegan con el producto.

D. Entfernen Sie vor der Benutzung sämtliche Verpackungsmaterialien. Alle Informationen, Adressen und Telefonnummern bitte für mögliche Rückfragen aufbewahren. Der Packungsinhalt kann von den Bildern abweichen. Meccano behält sich das Recht vor, den Betrieb der Website www.meccano.com jederzeit einzustellen. Ein Erwachsener sollte regelmäßig sicherstellen, dass das Spielzeug keine Gefahr darstellt, und es gegebenenfalls entfernen. Kinder sollten beim Spielen beaufsichtigt werden.

NL. Verwijder de verpakking voor gebruik. Bewaar deze informatie, adressen en telefoonnummers voor toekomstig gebruik. Inhoud kan afwijken van illustraties. Meccano behoudt zich het recht voor de website www.meccano.com wanneer gewenst buiten gebruik te stellen. Een volwassene dient dit speelgoed regelmatig te controleren. In geval van schade of gevaar het speelgoed niet meer gebruiken. Houd toezicht als kinderen spelen.

I. Rimuovere l'imballo prima dell'uso. Conservare informazioni, indirizzi e numeri di telefono per riferimento futuro. Il prodotto potrebbe essere differente dalle immagini. Meccano si riserva il diritto di rimuovere il sito www.meccano.com in qualsiasi momento. Il giocattolo deve essere periodicamente controllato da un adulto per prevenire eventuali danni o rischi;

in caso di danno, sospendere l'uso. I bambini devono essere sorvegliati durante il gioco.

P. Remova totalmente a embalagem antes de utilizar. Guarde todos os endereços, números de telefone e demais informações para consulta e referência. O conteúdo poderá ser diferente das ilustrações. A Meccano reserva-se o direito de descontinuar o sítio www.meccano.com a qualquer altura. Um adulto deve verificar o brinquedo periodicamente para garantir que não há danos ou riscos. Se houver, é necessário que o brinquedo seja retirado de uso. Crianças devem ser supervisionadas enquanto brincam.

R. Снимите все упаковочные материалы перед использованием. Запишите указанные на упаковке адреса и номера телефонов, чтобы у вас была возможность связаться с нами. Содержимое упаковки может отличаться от иллюстрации. Компания Meccano оставляет за собой право прекратить использование сайта www.meccano.com в любое время. Взрослым следует время от времени проверять игру и следить за тем, чтобы она не была сломана и не представляла опасности для ребенка. В противном случае ее не следует использовать. Во время игры дети должны находиться под присмотром взрослых.

- ⚠ Warning: CHOKING HAZARD – Small parts.
- ⚠ Attention ! RISQUE D'ETOUFFEMENT – Contient de petits éléments.
- ⚠ Advertencia: PELIGRO DE ASFIXIA – Contiene piezas pequeñas. No conveniente para niños menores de 3 años.
- ⚠ Achtung: ERSTICKUNGSGEFAHR – Kleinteile.
- ⚠ Waarschuwing: VERSTIKKINGSGEVAAR – Kleine onderdelen.
- ⚠ Attenzione: RISCHIO DI SOFFOCAMENTO – Pezzi piccoli.
- ⚠ Aviso: PERIGO DE ASFIXIA – Peças pequenas.
- ⚠ Осторожно! ОПАСНОСТЬ УДУШЬЯ - Мелкие детали.



 NORTH AMERICA - 1-800-622-8339, customercare@spinmaster.com
UK - 0800 206 1191, serviceuk@spinmaster.com
IRELAND: 1800 992 249
FRANCE - 0800 909 150, servicefr@spinmaster.com
DEUTSCHLAND - 00800 0101 0222, Kundenservice@spinmaster.com
SCHWEIZ - 0800 561 350 • ÖSTERREICH - 0800 297 267
NEDERLAND - 0800 022 3683, klantenservice@spinmaster.com
BELGIË/BELGIQUE - 0800 77 688 • LUXEMBOURG - 800 2 8044
ITALIA - 800 788 532, servizio@spinmaster.com
MEXICO - 55 4160 7947, servicio@spinmaster.com
WWW.SPINMASTER.COM

SPIN MASTER LTD., 450 FRONT STREET WEST, TORONTO, ON M5V 1B6 CANADA.
DISTRIBUTED IN EU BY SPIN MASTER INTERNATIONAL, S.A.R.L.,
16 AVENUE PASTEUR, L-2310, Luxembourg. www.spinmaster.com



TM & © 2015 MECCANO for packaging, instructions and models built with this set. / TM & © 2015 MECCANO pour l'emballage, les notices et modèles de ce coffret. / ® MECCANO is an exclusive trademark of MECCANO. Spin Master logo is a trademark of Spin Master Ltd. / ® MECCANO est une marque de commerce exclusive de MECCANO. Le logo de Spin Master est une marque de commerce de Spin Master Ltd. / All rights reserved. / Tous droits réservés.

T91786_0005_20071474_GML_IB_R1_W1_MEC_MM10_Dinosaurs