

Building instructions
Notice de montage
Bauanleitung
Istruzioni di montaggio
Instrucciones de montaje
Instruções de montagem
Monteringsanvisning
Kokoomisohje
Monterings instruktioner
Montageanleitung
Οδηγίες συναρμολόγησης.
組立説明書



SPYKEE VOX



Made for
iPod

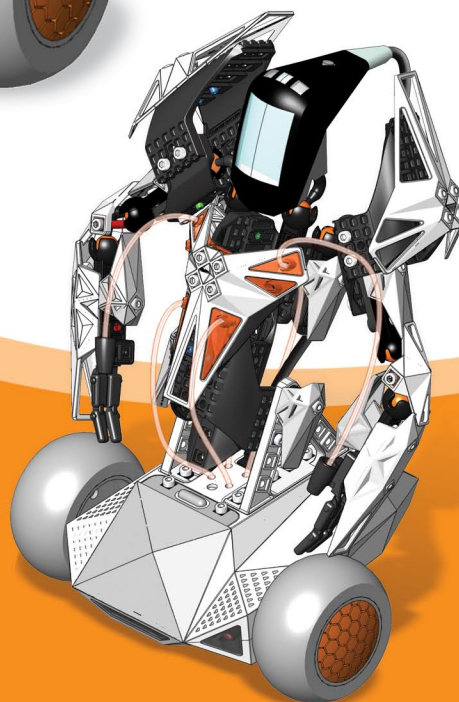
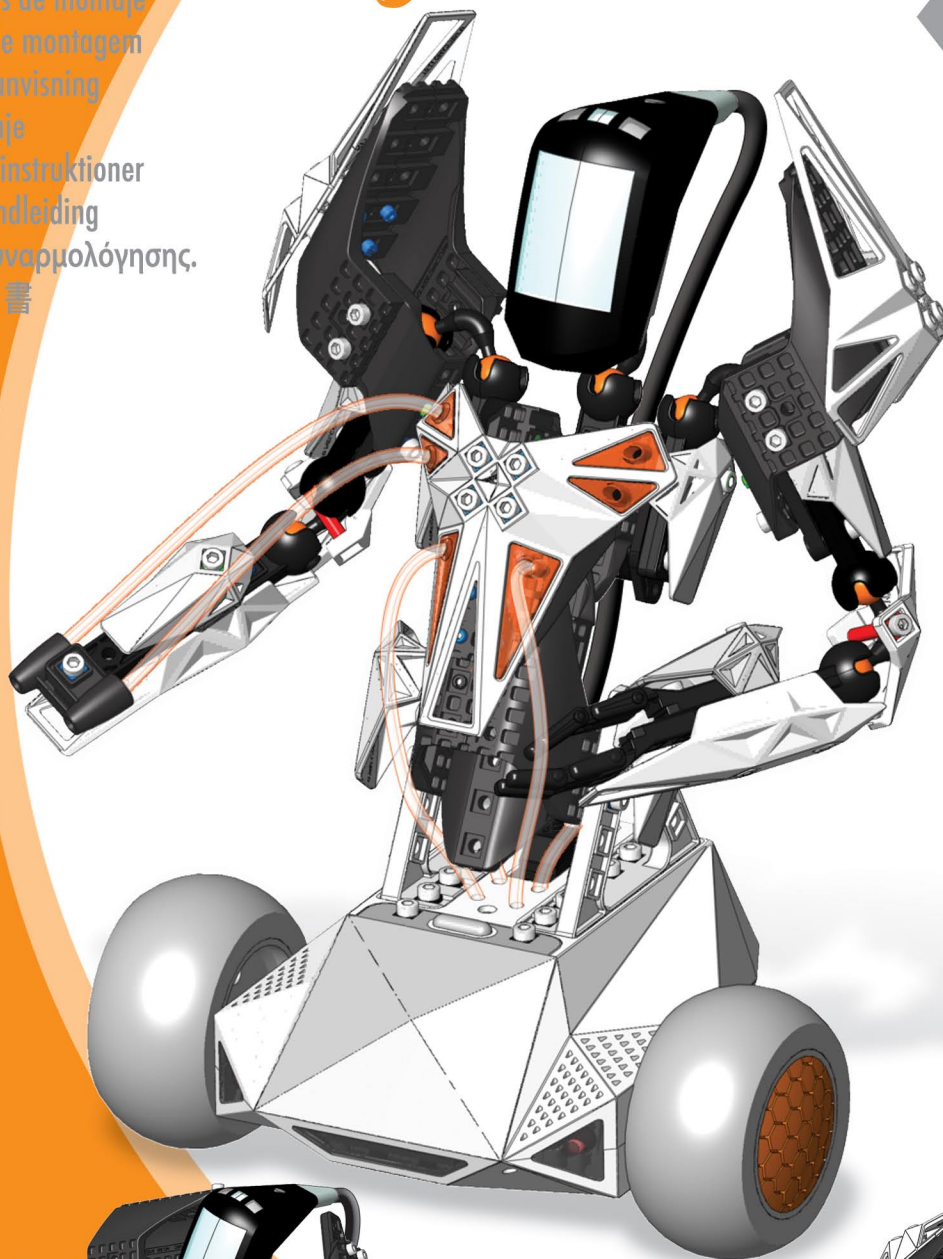

0870

8+

Page 5

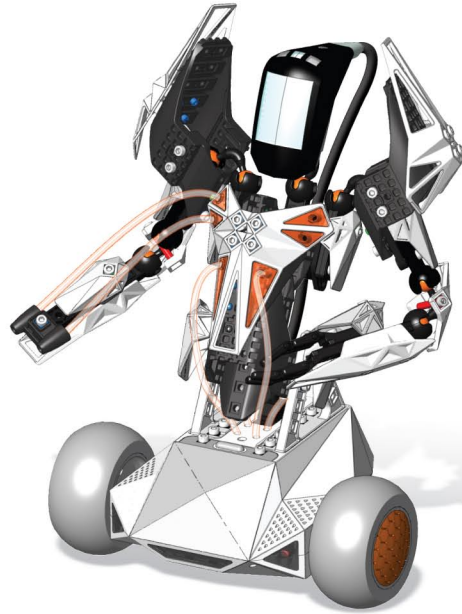

Page 11

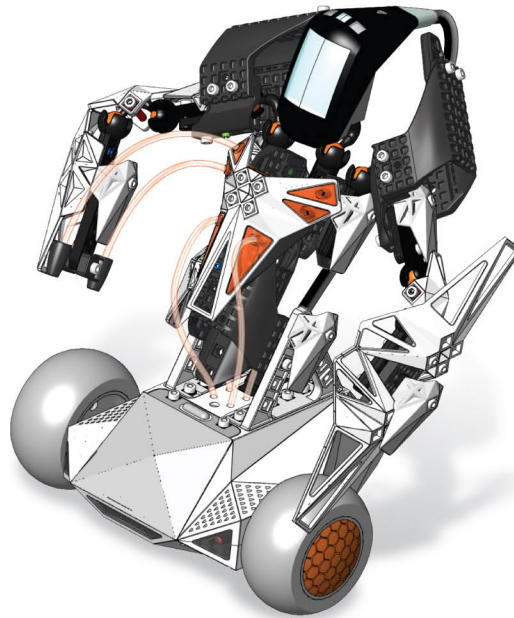

Page 13



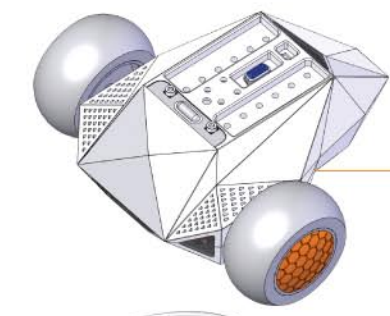

C064 X1

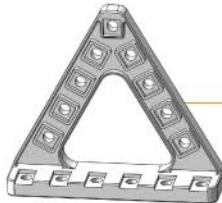

C049 X2

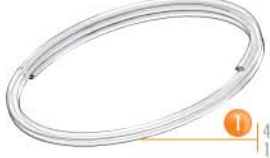

1 400mm 15 3/4" C083 X2

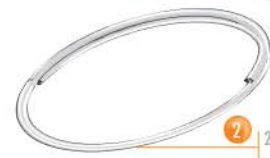

2 230mm 9" C082 X2



(iPod® Touch) C153 X1



(iPod® Nano 3G) C154 X1



(iPod® Nano & Nano 2G) C155 X1



C137 X1



C140 X1



B729 X4



C058 X2



B051 X1

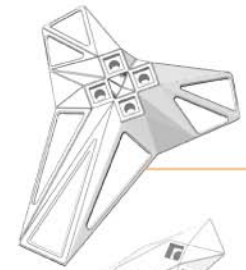

C139 X3



B722 X4



A420(0260C) X3



C141 X2



B732 X5



B998 X2



C142 X2



B756 X2



B996 X5



C138 X6



B953 X2



A260(0260J) X2



C138 X2



B727 X2



B967 X4



A238 X5



A 31,7mm 1 3/8" B775 X7



A 31,7mm 1 3/8" B776 X7



B 25,4mm 1" B726 X14



B 25,4mm 1" B746 X14



C 19mm 3/4" B725 X31



C 19mm 3/4" B745 X28



D 12,7mm 1/2" B724 X37



D 12,7mm 1/2" B744 X34



B858 X1



B757 X1



C176 X1

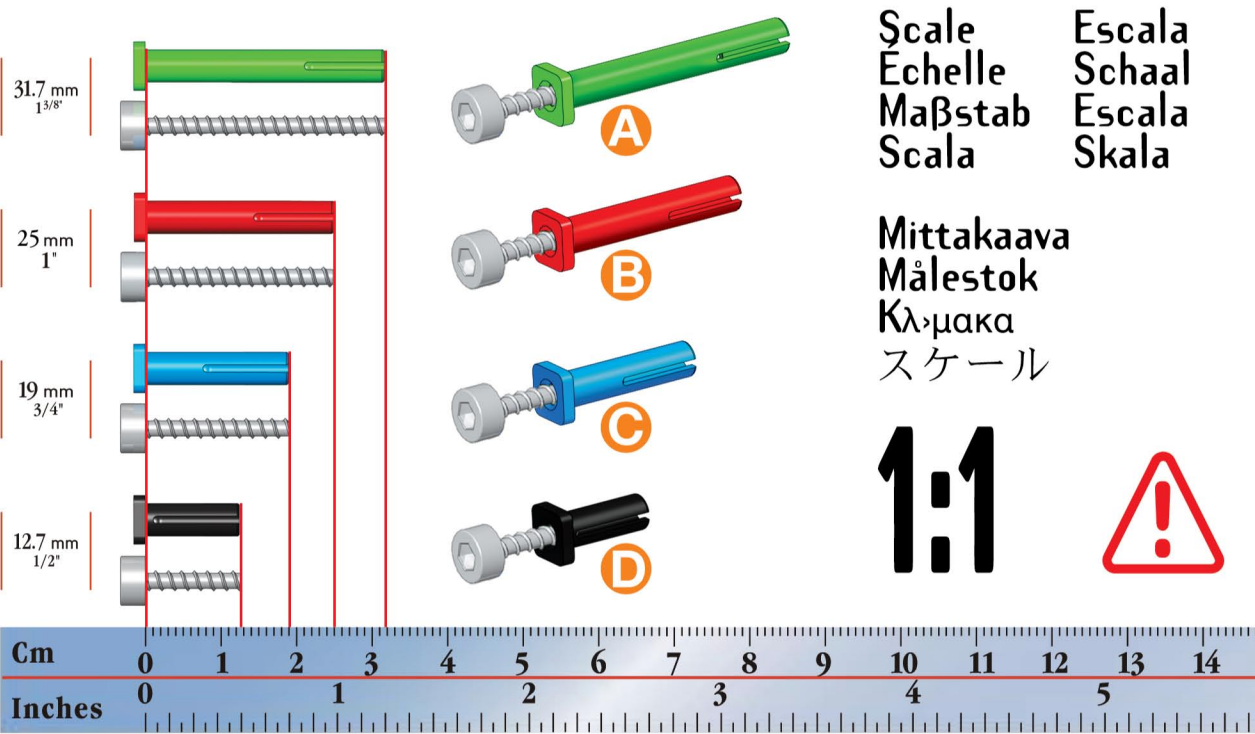

CONSTRUCTION TIPS
ASTUCES DE CONSTRUCTION
KONSTRUKTIONS-TIPPS

LE ASTUZIE DELLA COSTRUZIONE
LOS INGENIOS DE LA CONSTRUCCION
DE FIJNE KNEEPJES VAN NET BOUWEN

組み立ての秘訣



CHASSIS OF SPYKEE VOX:
Use 6 x "AA" Batteries.
(not included)

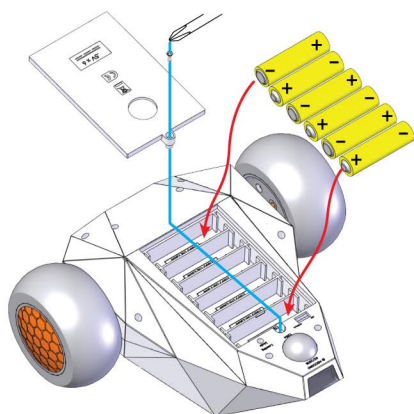

IR REMOTE:
Use 2 x "AAA" Batteries.
(not included)

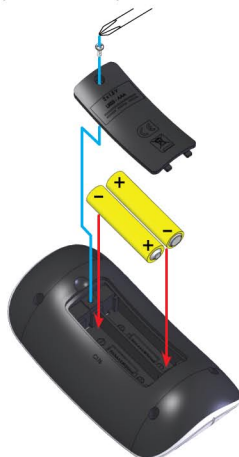



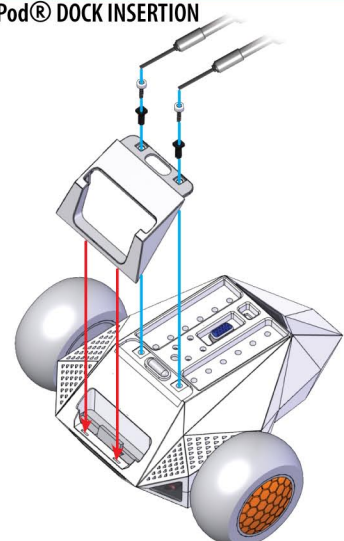

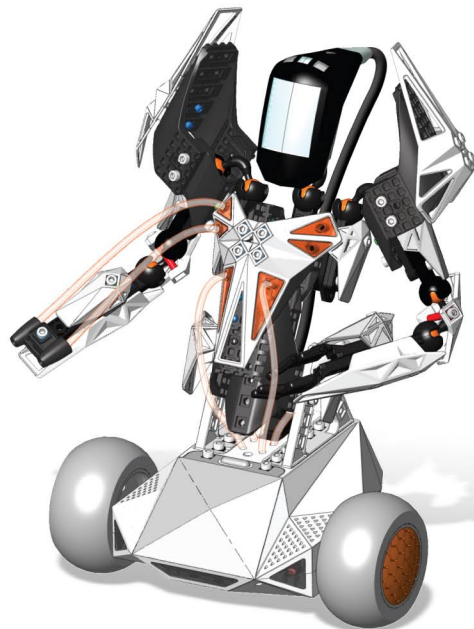

iPod® DOCK INSERTION

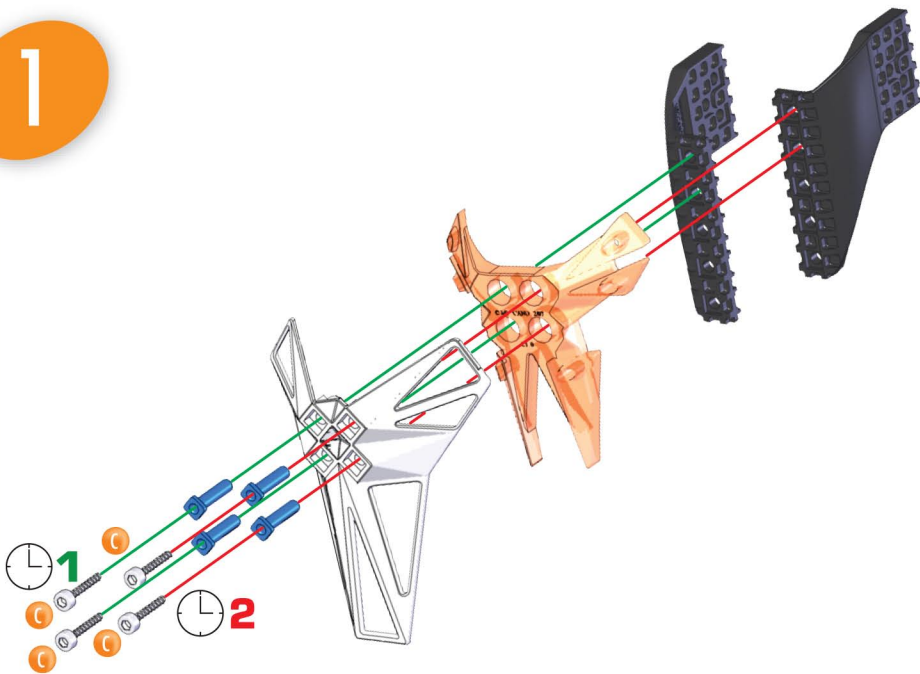

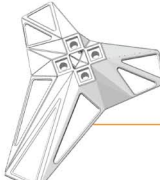

1



-  C139 **X1**
-  C140 **X1**
-  B729 **X1**
-  B722 **X1**
-  B725 **X4**
19mm 3/4"
-  B745 **X4**
19mm 3/4"

2

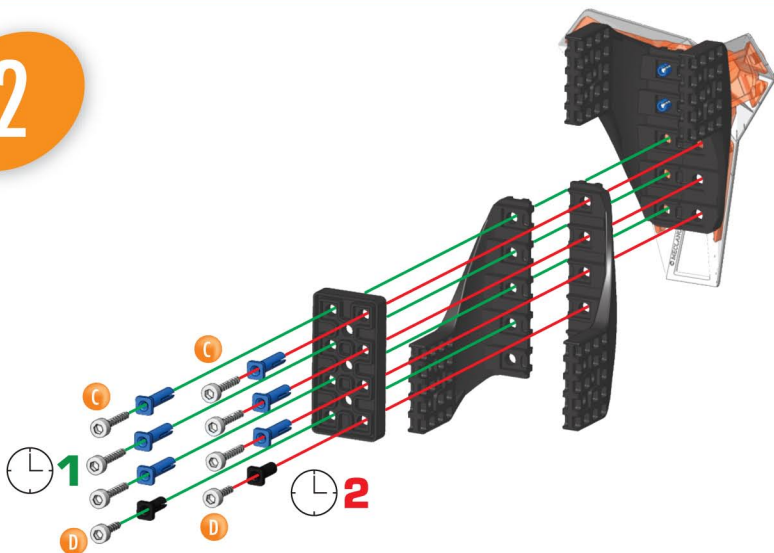

-  B729 **X1**
-  B722 **X1**
-  B756 **X1**
-  B725 **X6**
19mm 3/4"
-  B745 **X6**
19mm 3/4"
-  B724 **X2**
12,7mm 1/2"
-  B744 **X2**
12,7mm 1/2"

3

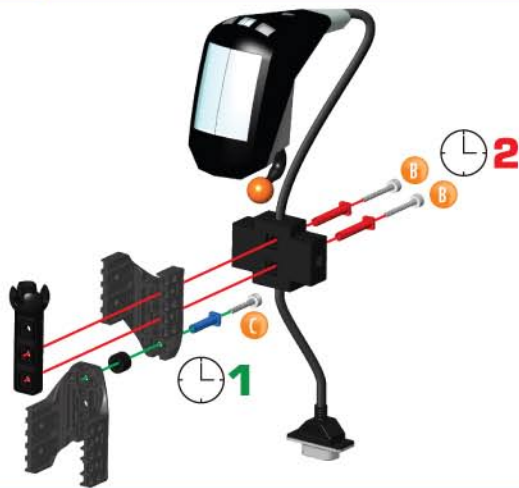

	C137	X1
	B732	X2
	B996	X1
	A238	X1
	25,4mm 1"	B726 X2
	25,4mm 1"	B746 X2
	19mm 3/4"	B725 X1
	19mm 3/4"	B745 X1

4



	C138	X1
	B967	X1
	A260	X1
	B996	X1
	31,7mm 1 3/8"	B775 X1
	31,7mm 1 3/8"	B776 X1
	19mm 3/4"	B725 X1
	19mm 3/4"	B745 X1
	12,7mm 1/2"	B724 X1
	12,7mm 1/2"	B744 X1

5

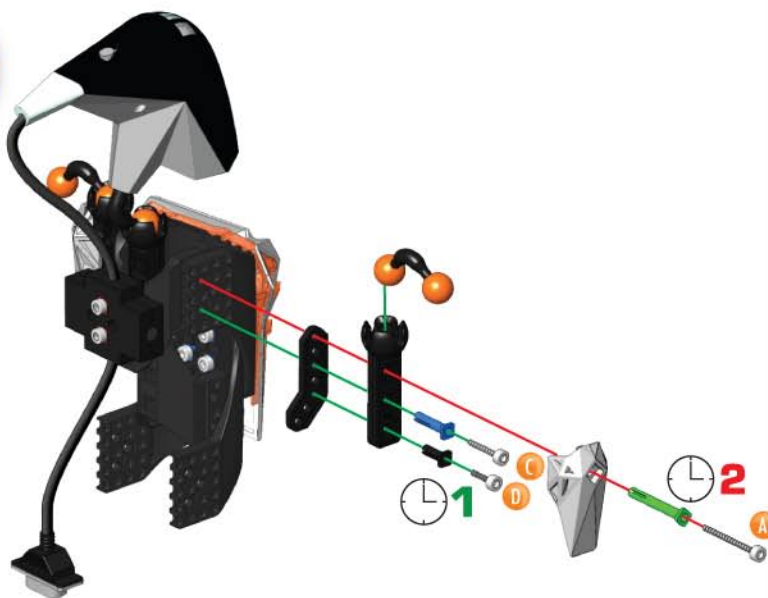

	C138	X1
	B967	X1
	A260	X1
	B996	X1
	31,7mm 1 3/8"	B775 X1
	31,7mm 1 3/8"	B776 X1
	19mm 3/4"	B725 X1
	19mm 3/4"	B745 X1
	12,7mm 1/2"	B724 X1
	12,7mm 1/2"	B744 X1

6



C064 X1

C049 X2



12,7mm 1/2" B724 X12

12,7mm 1/2" B744 X12

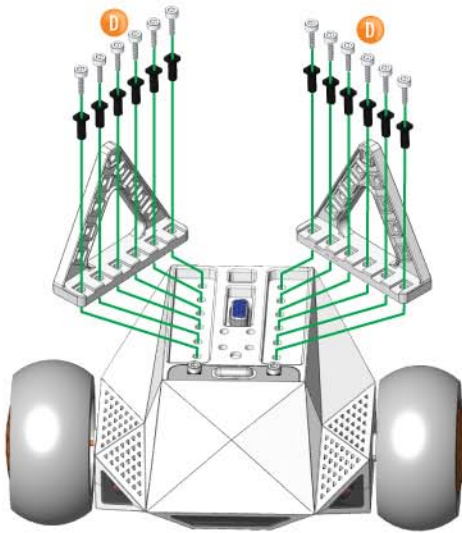

7

5 + 6 +



400mm 15 3/4" C083 X2

230mm 9" C082 X2



B732 X1

12,7mm 1/2" B724 X2

12,7mm 1/2" B744 X2

19mm 3/4" B725 X2

19mm 3/4" B745 X2

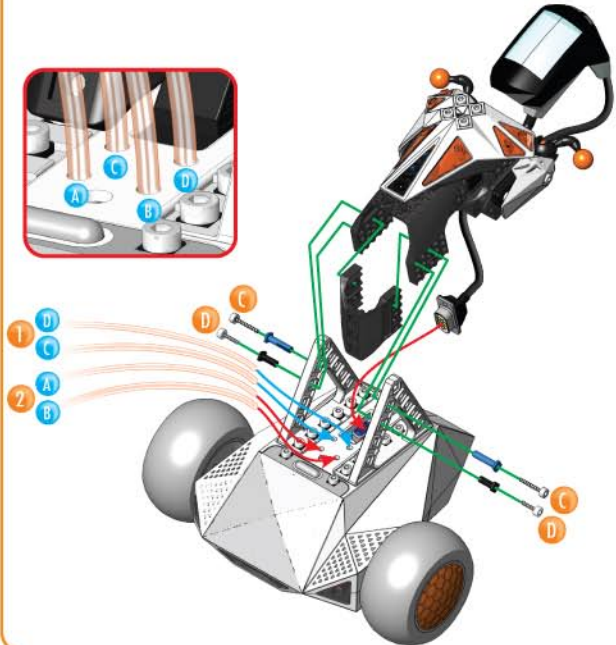
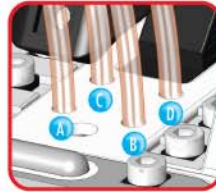

8



C138 X2



A238 X2



25,4mm 1" B726 X2



25,4mm 1" B746 X2

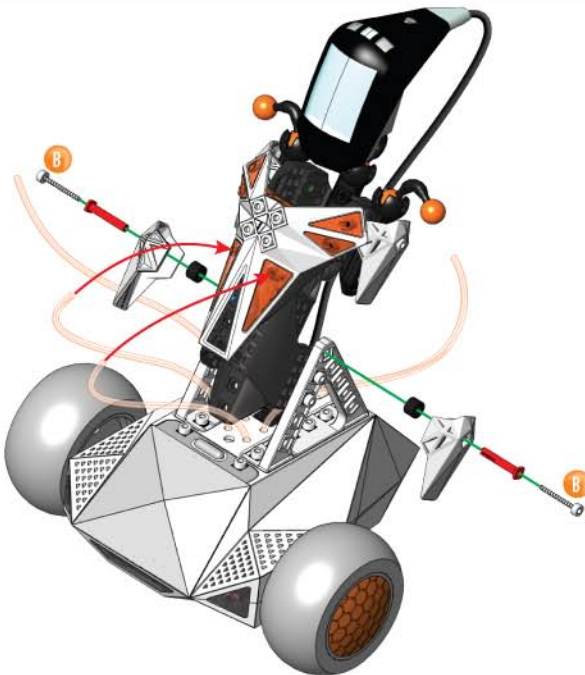

9



C142 X2



B967 X2



25,4mm 1" B726 X2



25,4mm 1" B746 X2

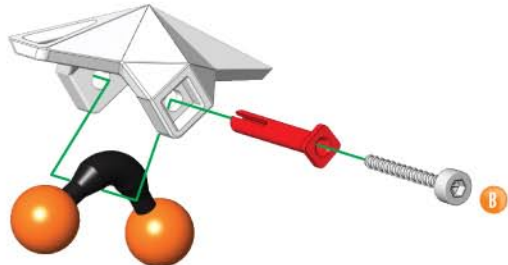

X2

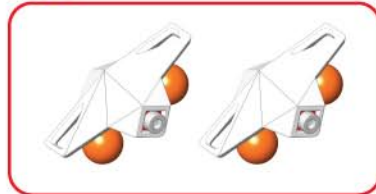

10

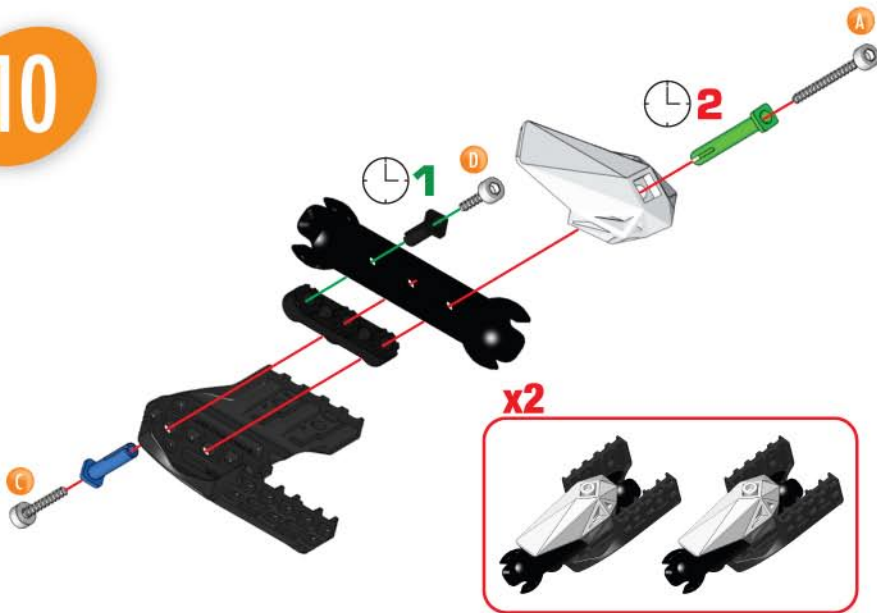

	C138	X2
	B732	X2
	B998	X2
	A420(0260C)	X2
	31,7mm 1 3/8"	B775 X2
	31,7mm 1 3/8"	B776 X2
	19mm 3/4"	B725 X2
	19mm 3/4"	B745 X2
	12,7mm 1/2"	B724 X2
	12,7mm 1/2"	B744 X2

11

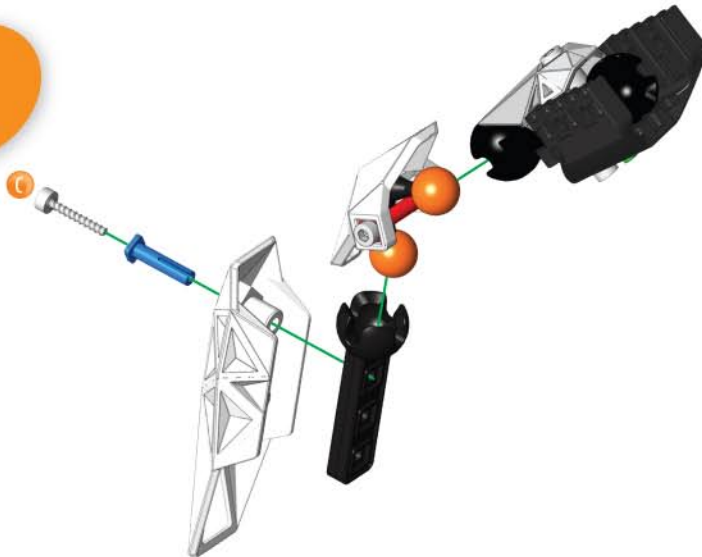

⑨ + ⑩ +

	C141	X1
	B996	X1
	19mm 3/4"	B725 X1
	19mm 3/4"	B745 X1

12

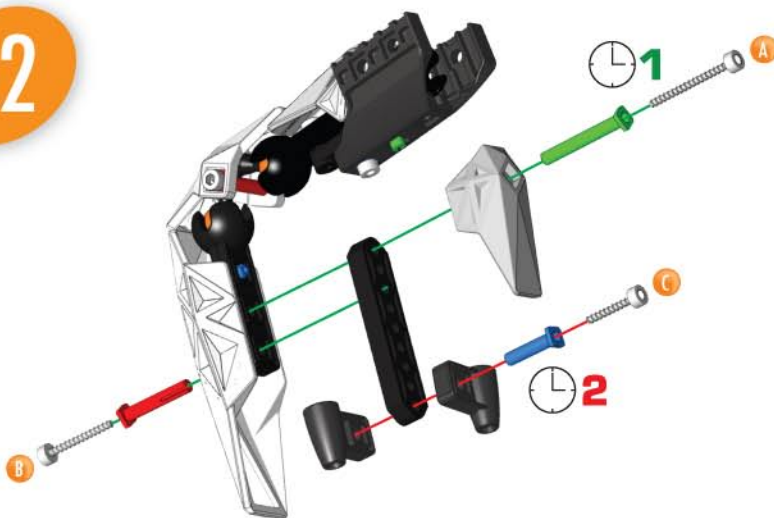

	C138	X1
	B051	X1
	B953	X2
	31,7mm 1 3/8"	B775 X1
	31,7mm 1 3/8"	B776 X1
	25,4mm 1"	B726 X1
	25,4mm 1"	B746 X1
	19mm 3/4"	B725 X1
	19mm 3/4"	B745 X1

13

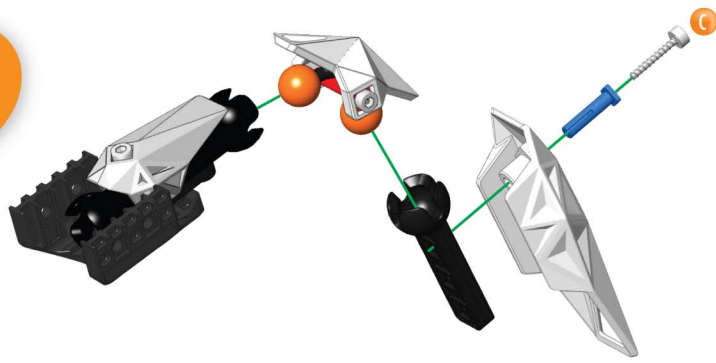

⑨ + ⑩ +

	C141	X1
	B996	X1
	19mm 3/4"	B725 X1
	19mm 3/4"	B745 X1

14

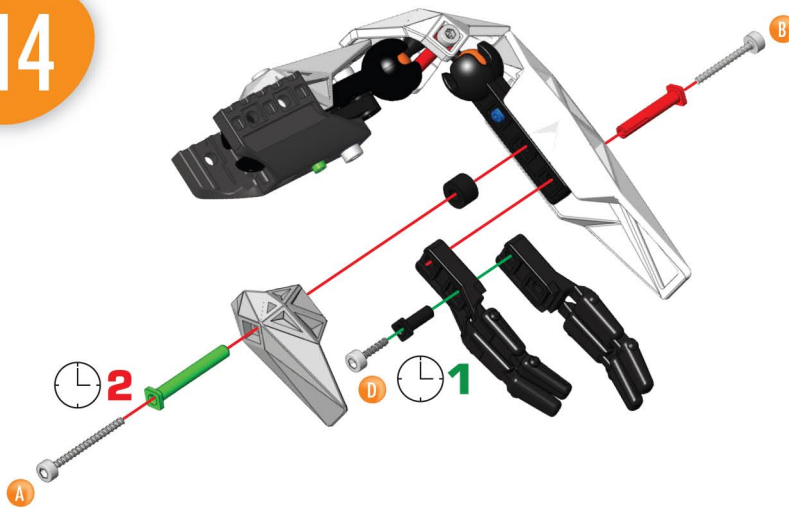

	C138	X1
	C058	X2
	A238	X1
	31,7mm 1 3/8"	B775 X1
	31,7mm 1 3/8"	B776 X1
	25,4mm 1"	B726 X1
	25,4mm 1"	B746 X1
	12,7mm 1/2"	B724 X1
	12,7mm 1/2"	B744 X1

15

	C139	X2
	B729	X2
	B722	X2
	19mm 3/4"	B725 X8
	19mm 3/4"	B745 X8

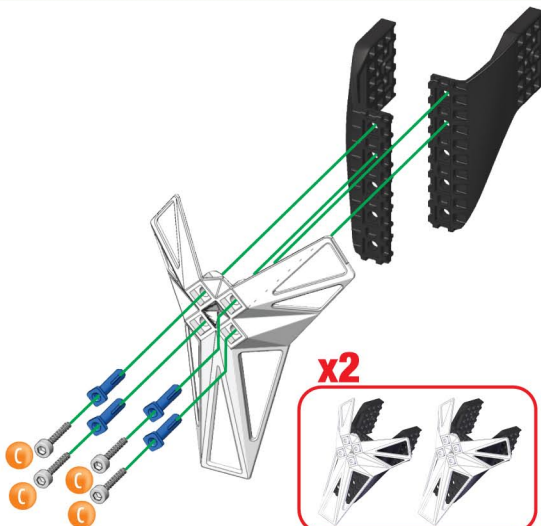

16

⑫ + ⑮ +

	12,7mm 1/2"	B724 X4
	12,7mm 1/2"	B744 X4

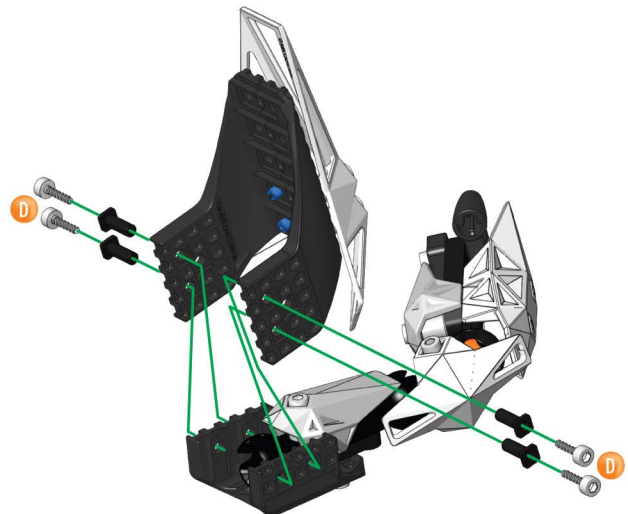

17

14 + 15 +

	D	12,7mm 1/2"	B724	X4
	D	12,7mm 1/2"	B744	X4

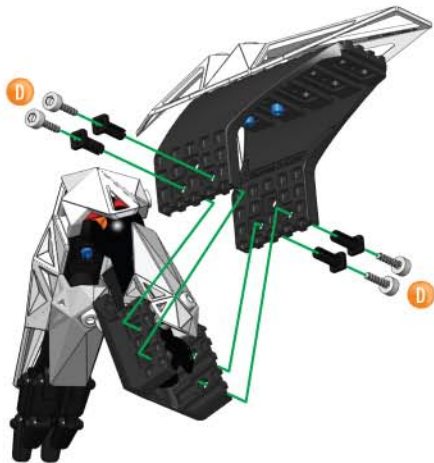

18

8 + 16 + 17 +



19

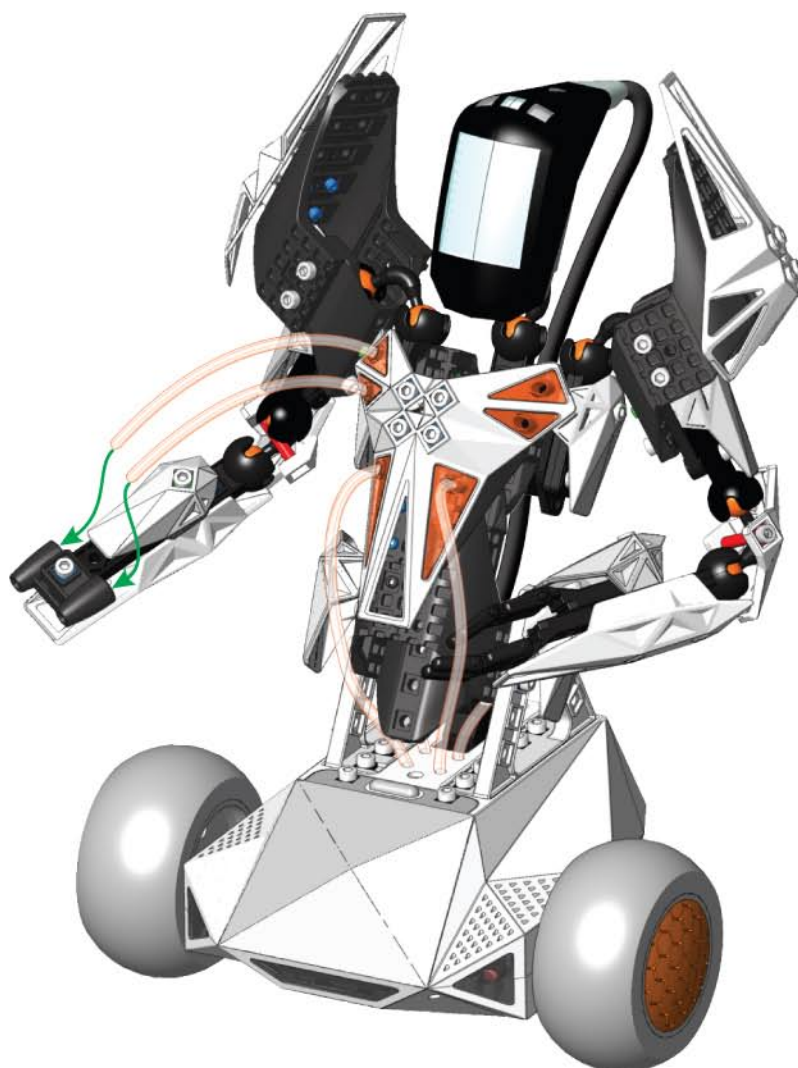

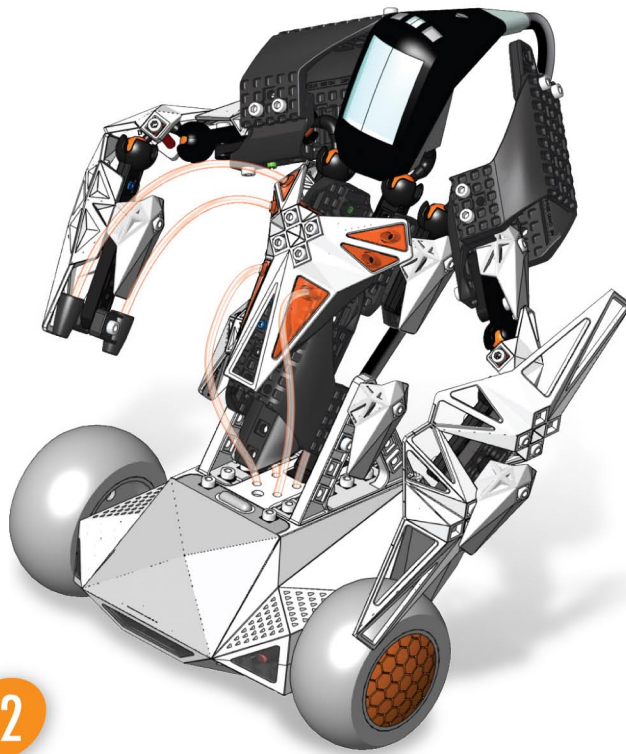

p5-p8 1 - 12

13

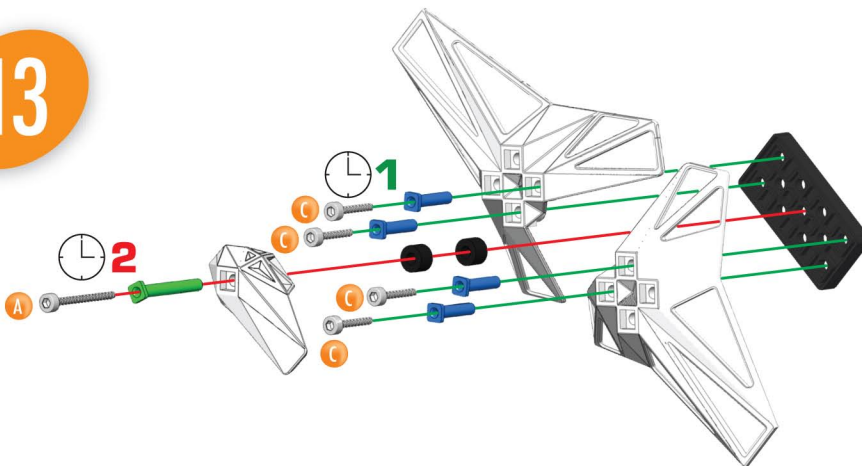

	C138	X1		
	C139	X2		
	B756	X1		
	A238	X2		
	A	31,7mm 1 3/8"	B775	X1
	A	31,7mm 1 3/8"	B776	X1
	C	19mm 3/4"	B725	X4
	C	19mm 3/4"	B745	X4

14

9 + 10 + 13 +

	A420	X1		C	19mm 3/4"	B725	X2
	B996	X1		C	19mm 3/4"	B745	X2

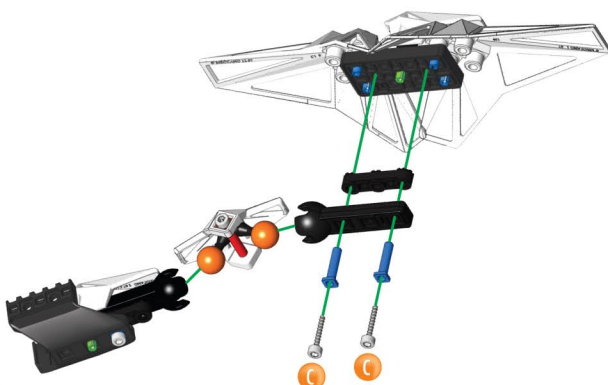

15

	B722	X2		
	B729	X2		
	B727	X2		
	D	12,7mm 1/2"	B724	X4
	D	12,7mm 1/2"	B744	X4

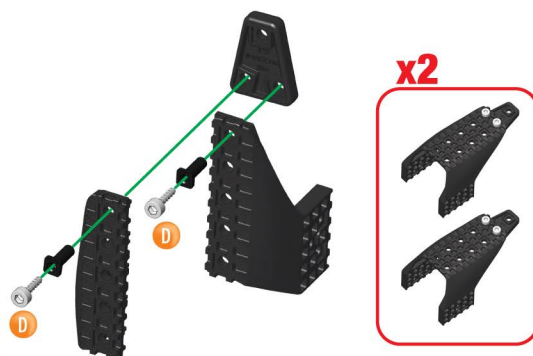

16

12 + 15 +

- (D) | 12,7mm | B724 X4
- (D) | 12,7mm | B744 X4



17

14 + 15 +

- (D) | 12,7mm | B724 X4
- (D) | 12,7mm | B744 X4

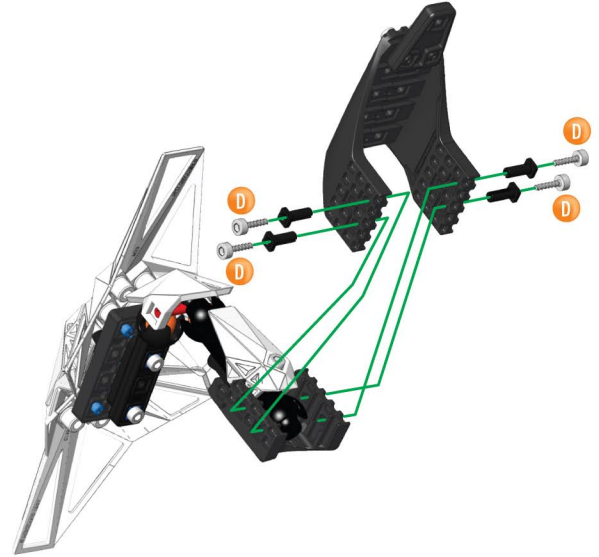

18

8 + 16 + 17 +

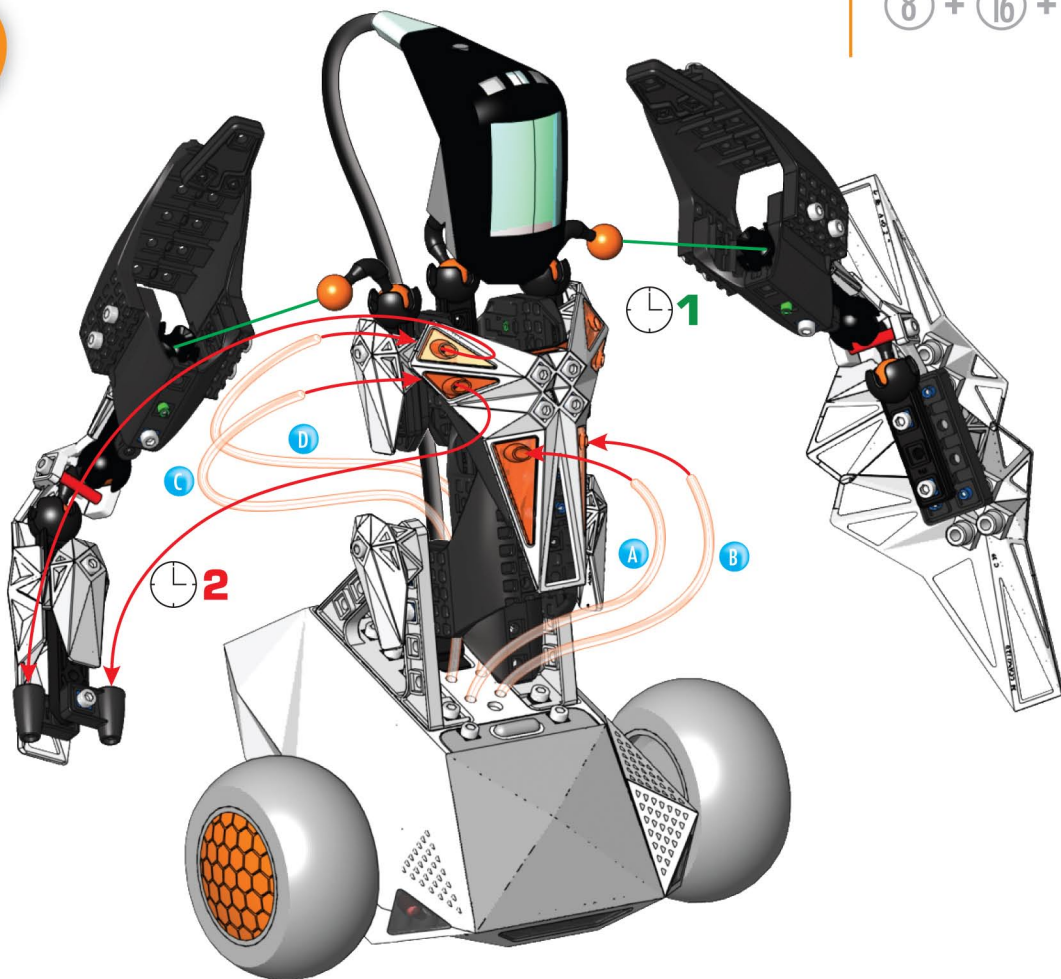

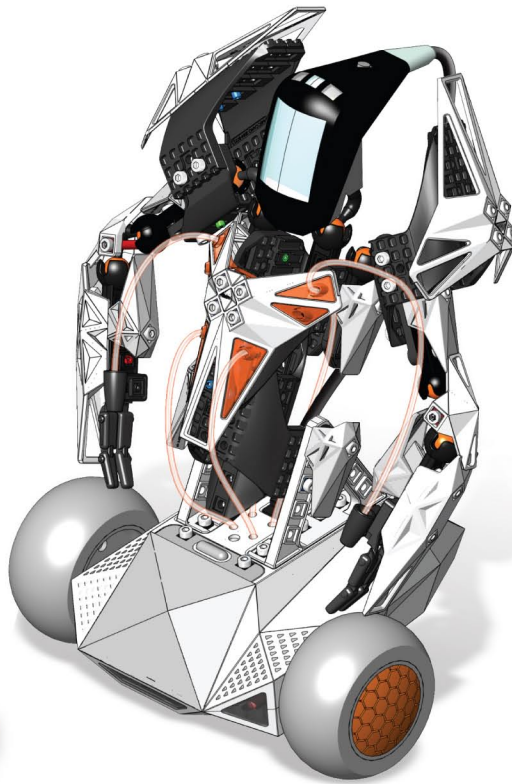

p5-p8 1 - 11

12

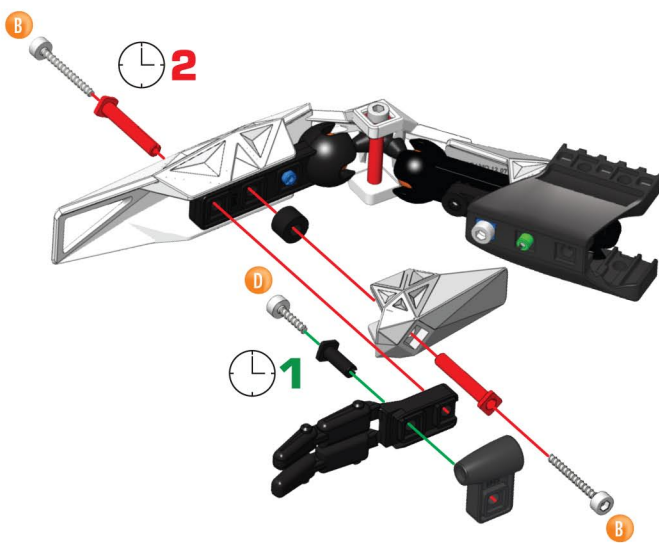

11 +

	C058	X1
	C138	X1
	B953	X1
	A238	X1
	25,4mm 1"	B726 X2
	25,4mm 1"	B746 X2
	12,7mm 1/2"	B724 X1
	12,7mm 1/2"	B744 X1

13

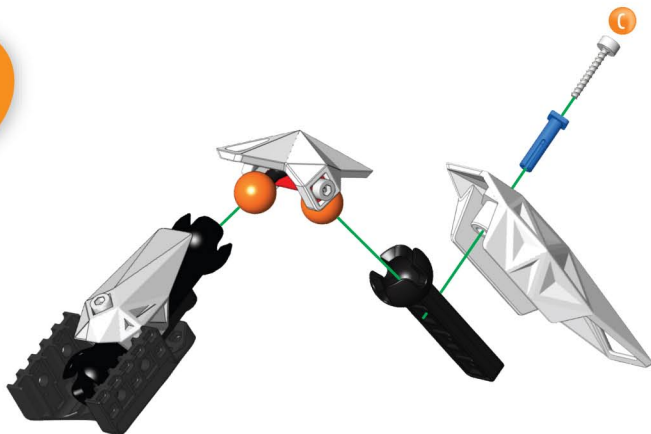

9 + 10 +

	C141	X1
	B996	X1
	19mm 3/4"	B725 X1
	19mm 3/4"	B745 X1

14

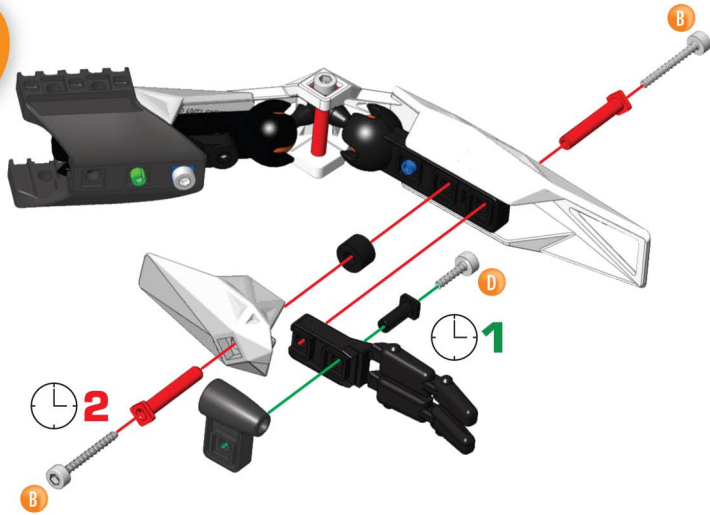

13 +

-  C058 **X1**
-  C138 **X1**
-  B953 **X1**
-  A238 **X1**
-  B726 **X2** | 25,4mm | 1"
-  B746 **X2** | 25,4mm | 1"
-  B724 **X1** | 12,7mm | 1/2"
-  B744 **X1** | 12,7mm | 1/2"

15

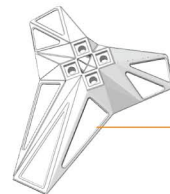
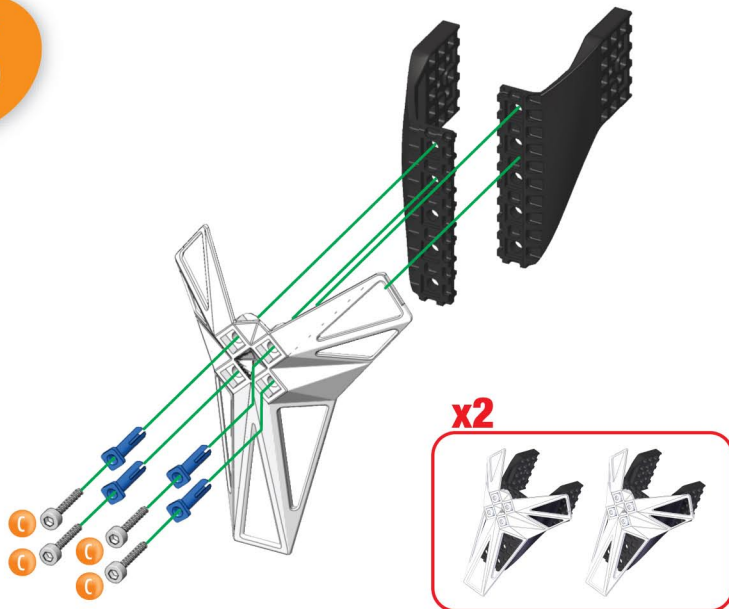

C139 **X2**

B729 **X2**

B722 **X2**

B725 **X8** | 19mm | 3/4"

B745 **X8** | 19mm | 3/4"

16

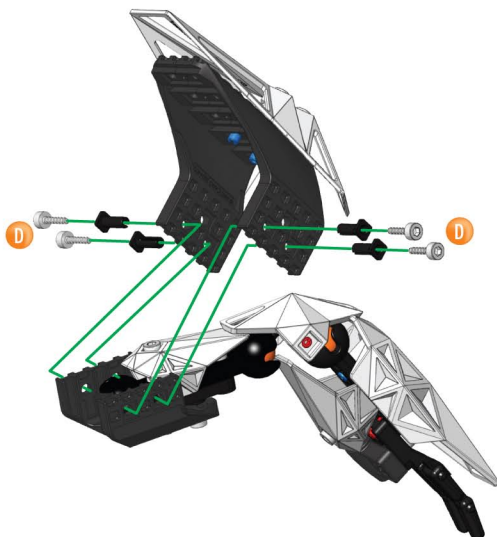

12 + 15 +

-  B724 **X4** | 12,7mm | 1/2"
-  B744 **X4** | 12,7mm | 1/2"

17

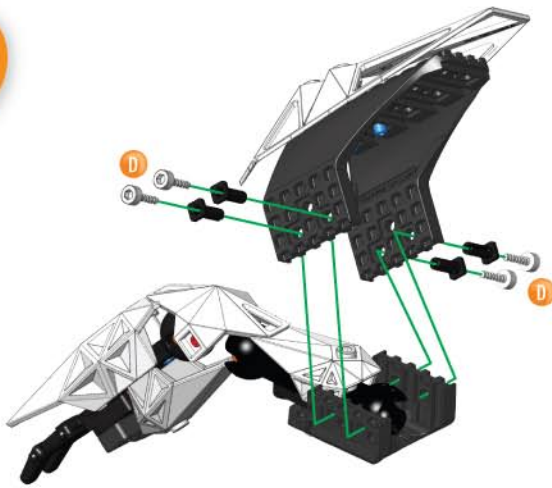

14 + 15 +

- | | | | |
|---|----------|----------------|----------------|
|  | D | 12,7mm
1/2" | B724 X4 |
|  | D | 12,7mm
1/2" | B744 X4 |

18

8 + 16 + 17 +

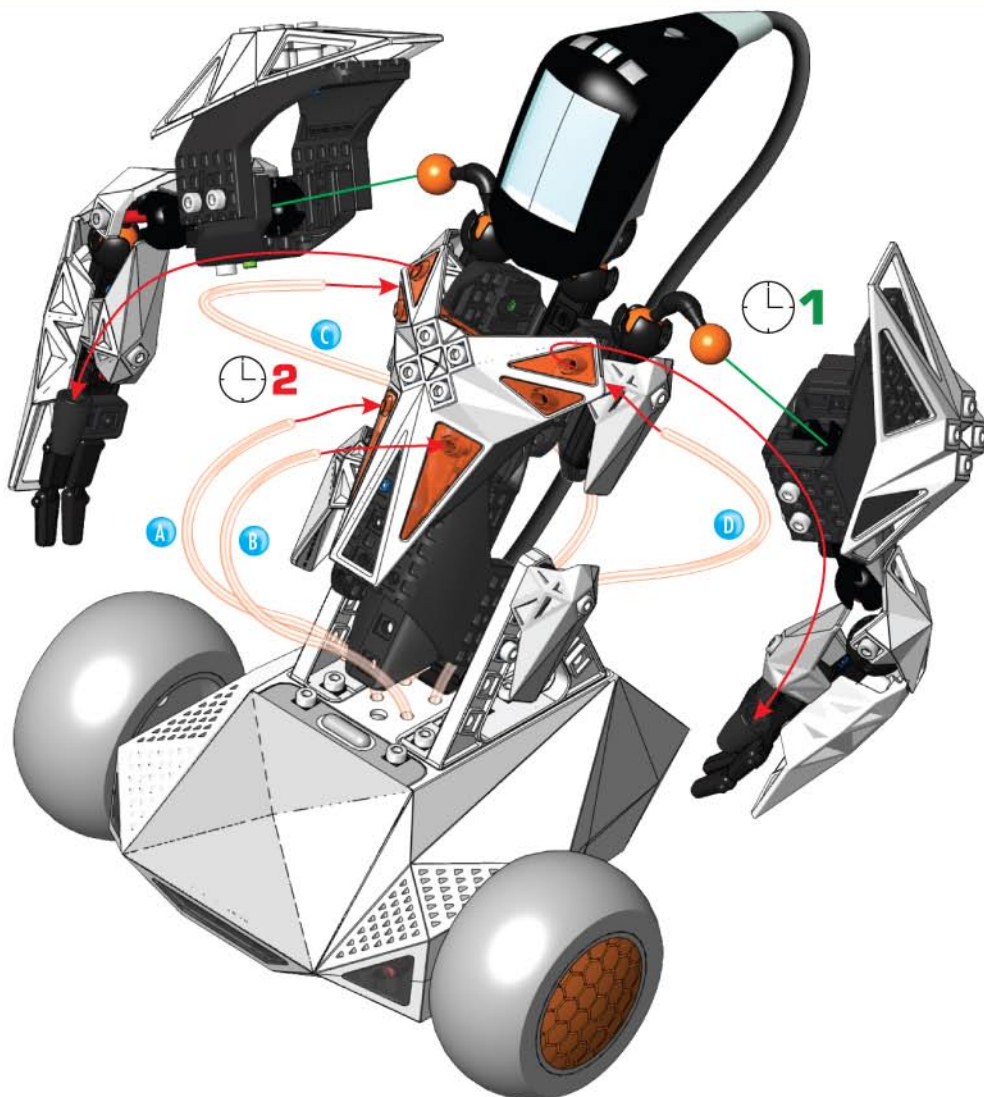

GB USA Many of the models and component parts are unique and original designs which are the property of MECCANO. They are protected by national legislation as industrial designs trademarks and/or copyrights throughout many countries. For detailed information, please contact: MECCANO. Meccano shall have no responsibility for (I) failure to follow instructions, (II) use of parts for any purpose other than as specified in the instructions (III) any alteration of any parts or components. MECCANO respects children's safety: all models are tested by children.

F De nombreux modèles et pièces sont des créations originales, propriétés de MECCANO et sont protégés par les législations nationales sur les dessins et modèles, marques et/ou droits d'auteurs. Pour toute information, merci de contacter : MECCANO. La responsabilité de MECCANO ne saurait être engagée en cas d'accident survenu à la suite (I) du non respect des instructions de montage (II) d'une utilisation des pièces autre que celle proposée dans la notice (III) d'une altération ou de la modification des pièces. La société MECCANO respecte la sécurité des enfants : ses modèles sont testés par des enfants.

D Zahlreiche Modelle und Teile sind Erfindungen und Eigentum der Firma MECCANO. Sie sind durch Inland-Gesetze über Zeichnungen und Modelle sowie Warenzeichen und/oder Urheberrechte geschützt. Für zusätzliche Auskünfte wenden Sie sich bitte an : MECCANO. Die Firma Meccano haftet nicht für Unfälle, die aus der (I) Nichteinhaltung der Bauanleitung, der (II) Verwendung anderer als in der Bauanleitung angegebenen Teile oder der (III) Änderung oder Modifikation der Teile resultieren. Alle Modelle der Firma Meccano wurden von Kindern getestet und entsprechen den Sicherheitsnormen.

I Numerosi modelli e pezzi sono creazioni originali della MECCANO e sono protetti dalle legislazioni nazionali sui disegni e modelli, marche e/o diritti d'autore. Per qualsiasi informazione, vogliate prendere contatto con : MECCANO. Meccano declina ogni responsabilità in caso d'incidenti sopravvenuti in seguito (I) a non rispetto delle istruzioni di montaggio (II) utilizzo dei pezzi per funzioni diverse da quelle previste nel manuale (III) alterazione e/o modifica dei pezzi. La società MECCANO rispetta la sicurezza dei bambini : i suoi modelli vengono testati dai bambini stessi.

E Numerosos modelos y piezas son creaciones originales, propiedades de MECCANO y están protegidos por las legislaciones nacionales en lo que concierne a los dibujos y modelos, marcas y/o derechos de autor. Para cualquier información, sírvase ponerse en contacto con : MECCANO. MECCANO carece de responsabilidad en caso de accidente debido a: (I) el incumplimiento de las instrucciones de montaje (II) una utilización de las piezas diferente a la que se indica en las instrucciones (III) una alteración o modificación de las piezas. La sociedad MECCANO respeta la seguridad de los niños : sus modelos están probados por niños.

P Vários modelos e peças são criações originais, propriedades da MECCANO e são protegidos pelas legislações nacionais relativas aos desenhos e modelos, às marcas e/ou aos direitos de autor. Para qualquer informação, é favor contactar : MECCANO. A Sociedade MECCANO não poderá ser responsabilizada pelos acidentes provocados: (I) pela falta de cumprimento das instruções de montagem (II) pelo uso indevido das peças ou (III) pela modificação ou alteração das peças. A Sociedade MECCANO respeita a segurança das crianças : os seus modelos foram testados por crianças.

GB USA 1) Made for iPod nano & iPod touch only
2) Apple is not responsible for the operation of this device or its compliance with safety and regulatory standards. Apple & iPod are registered trademarks of Apple Inc., registered in the US and other countries.

F 1) Compatible iPod touch & iPod nano uniquement.
2) Apple n'est pas responsable du fonctionnement de cet appareil ou de sa conformité avec les standards de sécurité et de normes. Apple et iPod sont des marques enregistrées d'Apple Inc., enregistrées aux Etats-Unis et autres pays.

D 1) Kun kompatibel med iPod touch & iPod nano.
2) Apple er ikke ansvarlig for denne enheds funktion eller dens overensstemmelse med sikkerhedsstandarder og normer. Apple og iPod er registrerede varemærker tilhørende Apple Inc, registreret i USA og andre lande.

I 1) Compatibile unicamente con iPod touch e iPod nano.
2) Apple non è responsabile del funzionamento di questo apparecchio o della sua conformità con gli standard di sicurezza e norme. Apple e iPod sono marchi registrati di Apple Inc., depositati negli Stati Uniti e in altri paesi.

E 1) Compatible solo con iPod touch & iPod nano.
2) Apple no es responsable del funcionamiento de este aparato o de su conformidad con los estándares de seguridad y los normativos. Apple e iPod son marcas registradas de Apple Inc. en los Estados Unidos y otros países.

P 1) Compatível iPod touch e iPod Nano unicamente.
2) A Apple não se responsabiliza pelo funcionamento deste aparelho ou pela respectiva conformidade com as normas de segurança e outras normas. A Apple e a iPod são marcas registadas da Apple Inc., registadas nos Estados Unidos e outros países.

S Många modeller och delar bildar en unik och originell formgivning vilken är MECCANO egendom. Dessa modeller och delar är skyddade genom lagstiftning såsom industriell formgivning, varumärke och/eller upphovsmannarätt i ett flertal länder. För mer detaljerad information, var vänlig och kontakta MECCANO. MECCANO frångår sig allt ansvar i händelse av olycka till följd av (I) att monteringsinstruktionerna inte har respekterats (II) en annan användning av delarna än den som står i anvisningen (III) en förvanskning eller förändring av delarna. Företaget MECCANO respekterar barnsäkerheten : modellerna har testats av barn.

FIN Useat mallit ja osat ovat MECCANO: n omaisuutta olevaa alkuperäistä suunnittelua. Ne ovat kansallisilla lailla suojattua teollista muotoilua, tavaramerkkejä ja/tai kopiointioikeuksia. Pyydämme ottamaan yhteyden MECCANO: han kaikissa asioissa liittyvissä kysymyksissä. MECCANO ei vastaa eikä kata seuraavista syistä sattuneita onnettomuuksia: (I) ohjeiden vastainen kokoaminen, (II) muiden kuin ohjeissa ehdotettujen osien käyttö, (III) osien muuntelu tai eri tarkoitukseseen käyttö. MECCANO-yhtiö huolehtii lasten turvallisuudesta: lapset ovat testanneet mallimme.

DK Vore mange modeller og dele er originale fremstillinger og ejes af MECCANO. Tegninger modeller fabrikmærker og ophavsret er lovbeskyttede i hvert land. Yderligere oplysninger kan fås hos: MECCANO. MECCANO frasiger sig ethvert ansvar, såfremt der er sket uheld forårsaget af (I) at monteringsinstruktionerne ikke er blevet overholdt, (II) at delene er blevet brugt til andre formål, end dem der er beskrevet i betjeningsvejledningen, (III) eller at delene er blevet beskadiget eller ændret, MECCANO overholder sikkerhedsreglerne for børn: Alle modeller testes af børn.

NL Veel modellen en onderdelen zijn originele ontwerpen en eigendom van MECCANO en worden beschermd door de nationale wetgevingen op tekeningen en modellen, merken en/of auteursrechten. Voor informatie gelieve contact op te nemen met MECCANO. De verantwoordelijkheid van MECCANO is uitgesloten in geval van ongevalen voortvloeiend uit het niet naleven van de montage-instructies (I), uit het gebruik van andere onderdelen dan die zoals vermeld in de handleiding (II) of uit het veranderen of modifieren van de onderdelen (III). De firma MECCANO neemt de veiligheid van de kinderen in acht : de modellen zijn door kinderen getest.

GR Πολλά μοντέλα και ανταλλακτικά είναι αυθεντικά, ιδιοκτησία της MECCANO και προστατεύονται από τις εθνικές νομοθεσίες για τα μοντέλα τις μάρκες, ή τα διπλώματα ευρεσιτεχνίας. Για κάθε πληροφορία Για κάθε πληροφορία παρακαλώ απευθυνθείτε στη MECCANO. Η ευθύνη της MECCANO δεν δεσμεύεται σε περίπτωση ατυχήματος που έγινε συνέχεια (I) μη σεβασμού των οδηγιών συναρμολόγησης (II) χρήσης των τεμαχίων διαφορετικής από αυτήν που προτείνεται στις οδηγίες (III) καταστροφής ή αλλαγής των τεμαχίων. Η εταιρεία MECCANO σέβεται την ασφάλεια των παιδιών: τα μοντέλα της δοκιμάζονται από παιδιά.

JPN モデルならびに部品は、その多くが MECCANO 社 所有のオリジナル・デザインで、意匠・商標および/または著作権に関する国内法によって保護されています。詳細については、当社 (MECCANO) メカノ社は (I) 組立の注意事項を守らなかった場合、(II) 使用説明書に記載されたもの以外の部品を使用した場合、(III) 部品を改変・改造した場合などに起きた事故については責任を負うことはできません。メカノ社の全モデルは事前に子供たちによりテストを行い、その安全性を確認されております。

S 1) Valmistettu vain iPod nanoa ja iPod touchia varten
2) Apple ei ole vastuussa tämän laitteen käytöstä tai sen yhteensopivuudesta turvallisuus- ja säädösstandardien kanssa. Apple ja iPod ovat Apple Inc:in Yhdysvalloissa ja muissa maissa rekisteröityjä tavaramerkkejä.

FIN 1) För användning endast med iPod nano & iPod touch
2) Apple ansvarar inte för användningen av den här enheten eller för dess överensstämmelse med säkerhetsstandarder och föreskrifter. Apple & iPod är registrerade varumärken som tillhör Apple Inc. i USA och andra länder.

DK 1) Ausschließlich mit iPod touch & iPod nano kompatibel.
2) Apple haftet nicht für den Betrieb dieses Geräts oder dessen Konformität mit den gültigen Sicherheitsvorschriften und Normen. Apple und iPod sind eingetragene Handelsmarken von Apple Inc., mit Registrierung in den Vereinigten Staaten und weiteren Ländern.

NL 1) Uitsluitend te gebruiken voor iPod touch & iPod nano.
2) Apple kan niet verantwoordelijk gehouden worden voor het functioneren van dit apparaat of het voldoen aan veiligheids- en regelgevingsnormen. Apple en iPod zijn geregistreerde merken van Apple Inc., geregistreerd in de Verenigde Staten en andere landen.

GR 1) Συμβατό iPod touch & iPod nano μόνο.
2) Η Apple δεν είναι υπεύθυνη για τη λειτουργία αυτής της συσκευής ή για τη συμμόρφωσή της προς τα πρότυπα ασφαλείας και τους κανονισμούς. Apple και iPod είναι καταχωρημένα εμπορικά σήματα της Apple Inc., καταχωρημένα στις ΗΠΑ και σε άλλες χώρες.

JPN 1) 当製品は iPod touch & iPod nano へのみご使用いただけます。
2) Apple は当製品の機能またはその安全・規制基準の順守について、いかなる責任も負いません。Apple & iPod は米国および他の国々で登録された Apple Inc. の商標です。

Made in China for/Fabriqué en Chine pour/Fabricado en China por:



363, avenue de Saint Exupéry
62100 Calais - France
<http://www.meccano.com>
<http://www.erecator-sets.com>
© 10/2008 MECCANO

®MECCANO and ERECTOR are exclusive trademarks of MECCANO
All rights reserved

