

Instructions
Notice de montage
Bauanleitung
Istruzioni di montaggio

Instrucciones de montaje
Instruções de montagem
Monteringsanvisning
Kokoamisohje

Monteringsinstruktioner
Montagehandleiding
Οδηγίες συναρμολόγησης
Инструкции

7253

THE LAPINS CRETINS™

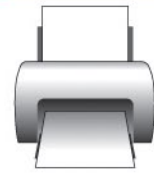

FR Merci d'imprimer à échelle 1 sans les marges de l'imprimante.
GB Please print at scale 1 without the printer margins.
DE Den Maßstab 1 bitte randlos drucken.
IT Stampare la scala 1 senza i margini della stampante.
ES Imprimir a escala 1 sin los márgenes de la impresora.
PT É favor imprimir escala 1 sem as margens da impressora.
SV Skriv ut i skala 1 utan skrivarens marginaler.
FI Portaiden painatuksen jälkeen reunat eivät saa näkyä.
NO Udskriv venligst i målestoksforhold 1 uden printermarginer.
GR Σας παρακαλώ τυπώστε την κλίμακα 1 μέσα στα περιθώρια του εκτυπωτή.
RU Пожалуйста, печатайте в масштабе 1:1 без отступов от края.

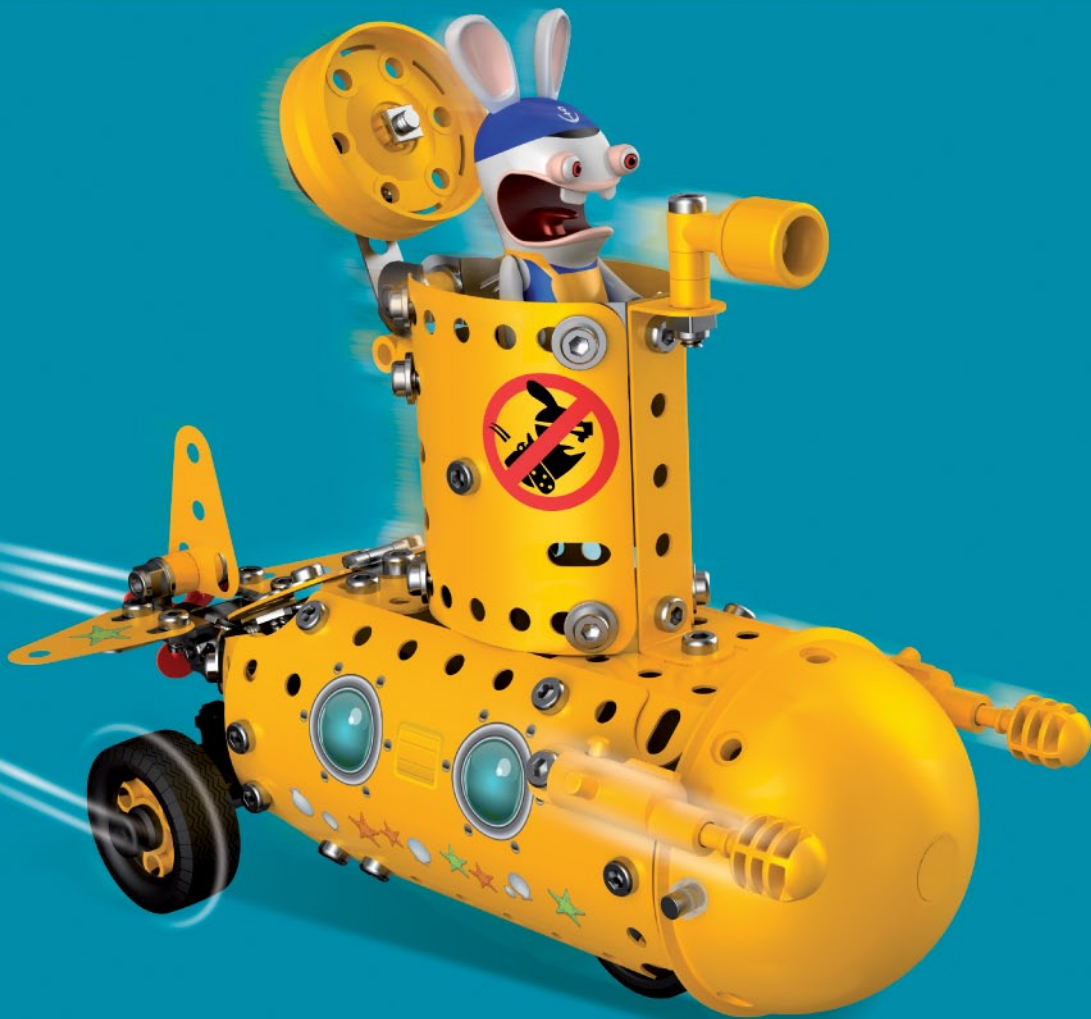

8+



CONSTRUCTION TIPS

LES ASTUCES DE CONSTRUCTION
 KONSTRUKTIJONS-TIPPS
 LE ASTUZIE DELLA COSTRUZIONE
 LOS INGENIOS DE LA CONSTRUCCIÓN
 DICAS PARA A MONTAGEM
 KOKOONPANON KIKAT
 BYGGKNEPEN
 ET PAR TIPS TIL BYGGARBEJDET
 DE FIJNE KNEEPJES VAN HET BOUWEN
 Τα έξυπνα κόλπα κατασκευής
 рекомендации по сборке

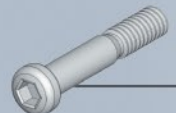
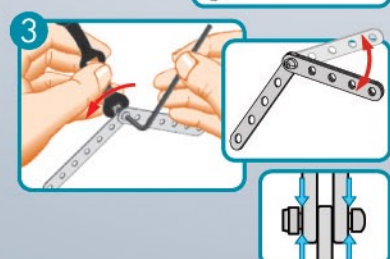
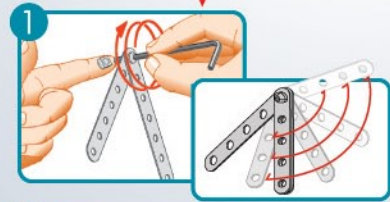
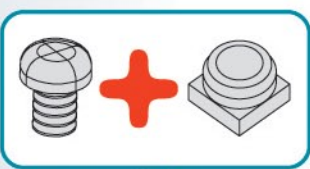
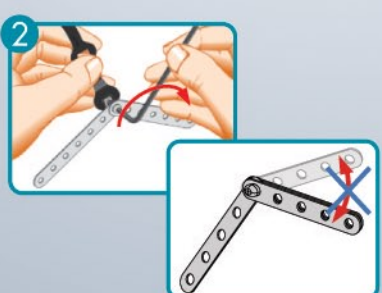
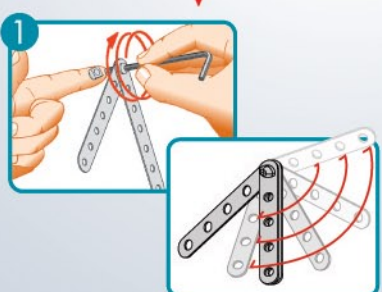
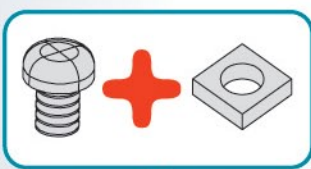
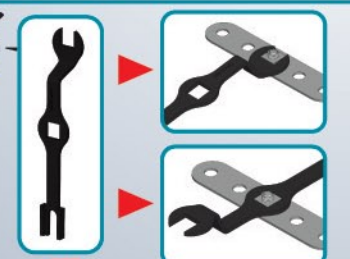
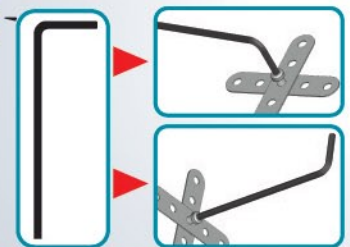

B3 23mm
19/32"

A347 (0147G) X3



B1 14,7mm
1/2"

A247 (0147D) X1



S3 12mm
1/2"

A411 (0111A) X3



S2 9,5mm
3/8"

A511 (0111C) X6



S1 5,8mm
15/64"

A637 (0037B) X49



A623 (0023C3P) X2



C863 X3



B031 X1



A545 (J3153) X1



A238 (0038A) X1



A338 (0038B) X9



A338 (0038B) X2



A259 (0059C) X3



A138 (0038) X16



A337 (0037A) X58



A737 (0037H) X2



A136 (0036C) X1



C088 X1





P080 X1

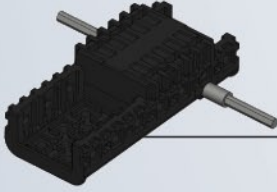

C383 X1



B639 X1

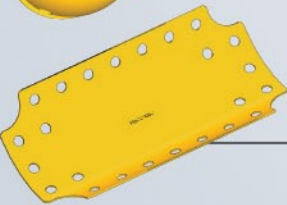

C951 X2

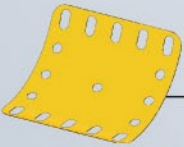

A200 (0200) X2

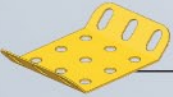

A851 (0051G) X2

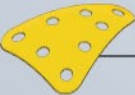

B695 X2



B608 X3



A307 (0103H) X1



A587 (0187B) X1



A342 (0142K) X3



A626 (0022BP) X1



A322 (0022CP3P) X2



75mm
3" | **A016 (0016B) X1**



32mm
1 1/4" | **A430 (0318C) X1**

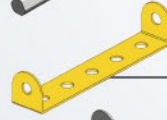

A448 (0048A) X1



A248 (0048) X1



A105 (0005) X1



B146 (0006) X1



C667 X2



A713 (0012B) X2



A812 (0812B) X1



A416 (0235G) X1



A277 (0077) X1



A321 (0321) X1



A425 (0260H) X1



C858 X1



C943 X2



C945 X2



A041 (0041B) X1



A336 (0114) X1



A712 (0012C) X12



A012 (0012) X5



A010 (0010) X2

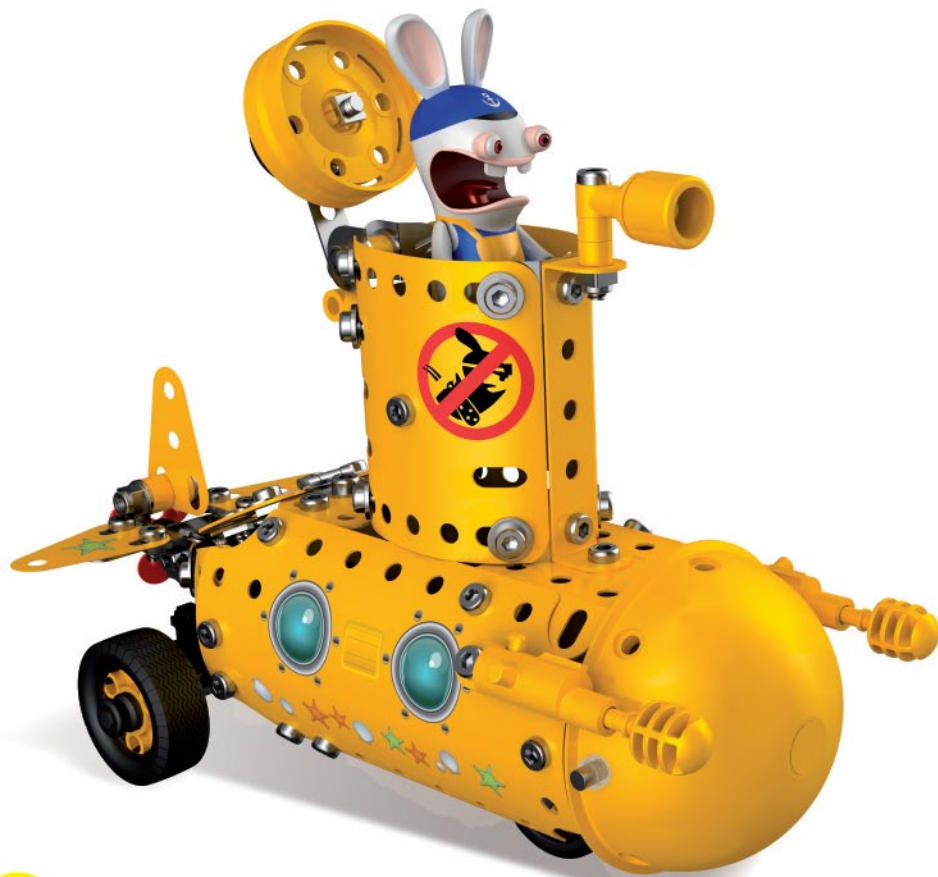

1

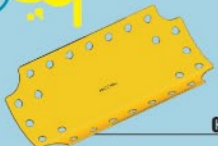

C951 X 1



A712 (0012C) X 1



S1 5,8mm | A637 (0037B) X 1
15/64"



A337 (0037A) X 1



S1

1:1

⚠ Scale 1 Escala 1 Mittakaava 1
Echelle 1 Schaal 1 Målestok 1
1:1 Maßstab 1 Escala 1 Калыпка 1
Scala 1 Skala 1 масштаб 1

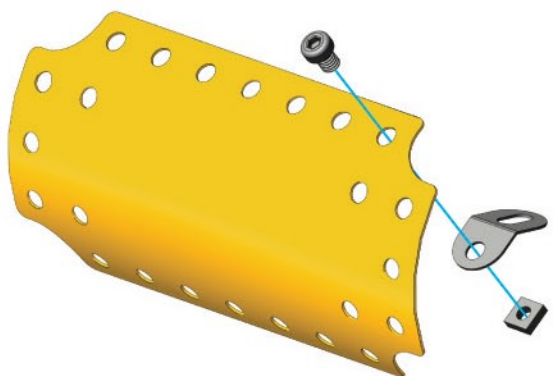

2



B695 X 1



S1 5,8mm | A637 (0037B) X 2
15/64"



A337 (0037A) X 2



S1

1:1

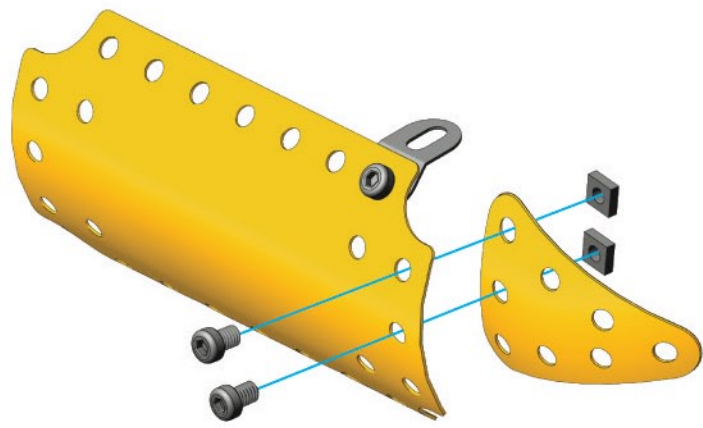

3

	A010 (0010) X 1
	A338 (00388) X 1
 9,5mm 3/8"	A511 (0111C) X 1
	A337 (0037A) X 1

 S2	1:1
 A338	

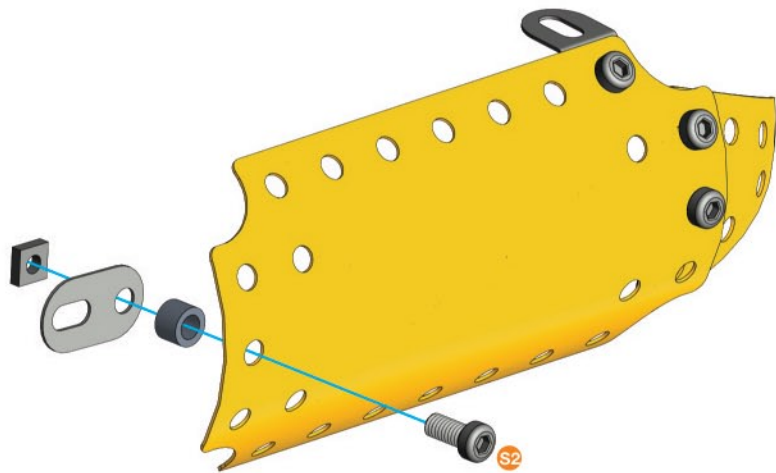



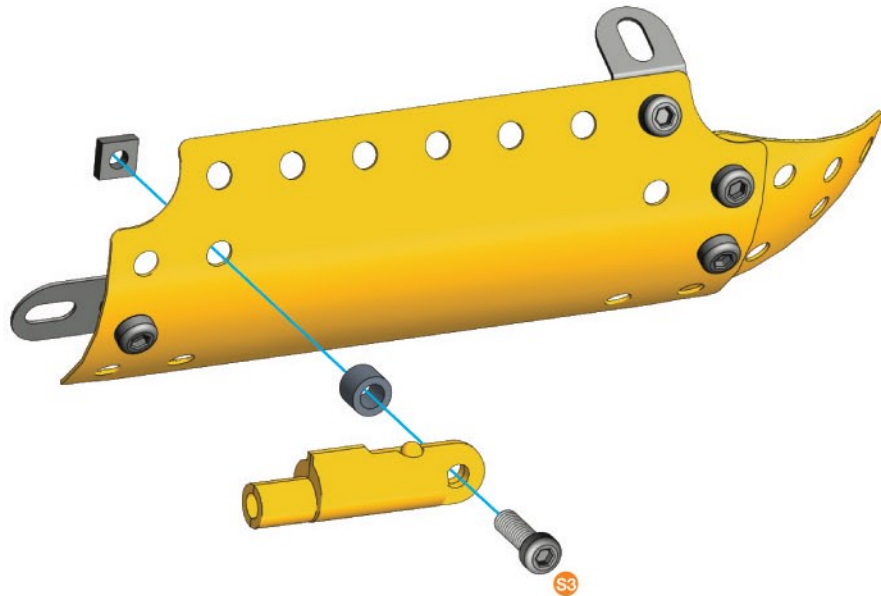

4

	C945 X 1
	A338 (00388) X 1
 12mm 1/2"	A411 (0111A) X 1
	A337 (0037A) X 1

 S3	1:1
 A338	

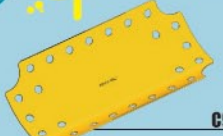

5

	C951 X 1
	A712 (0012C) X 1
 5,8mm 5/64"	A637 (0037B) X 1
	A337 (0037A) X 1

 S1	1:1
--	------------

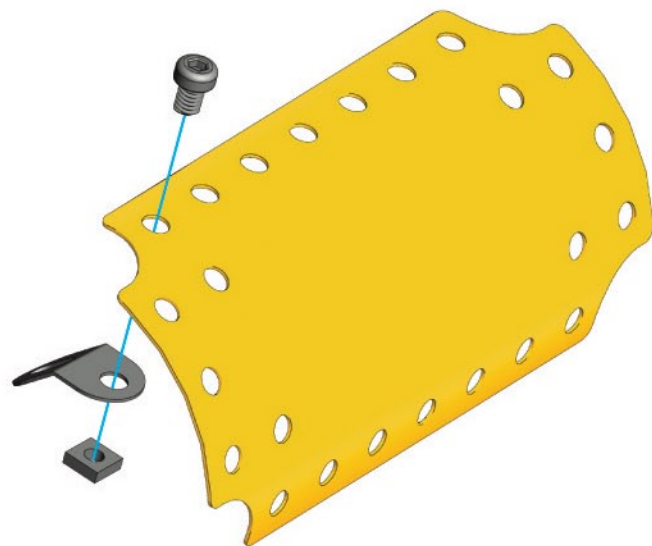

6

	B695 X1
5,8mm 15/64"	A637 (0037B) X2
	A337 (0037A) X2

	S1	1:1
--	-----------	------------

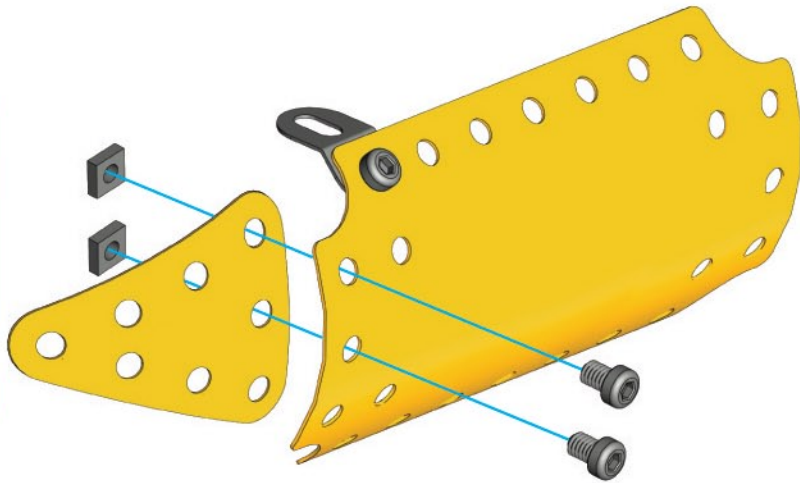

7

	A010 (0010) X1
	A338 (0038B) X1
9,5mm 3/8"	A511 (0111C) X1
	A337 (0037A) X1

	S2	1:1
	A338	

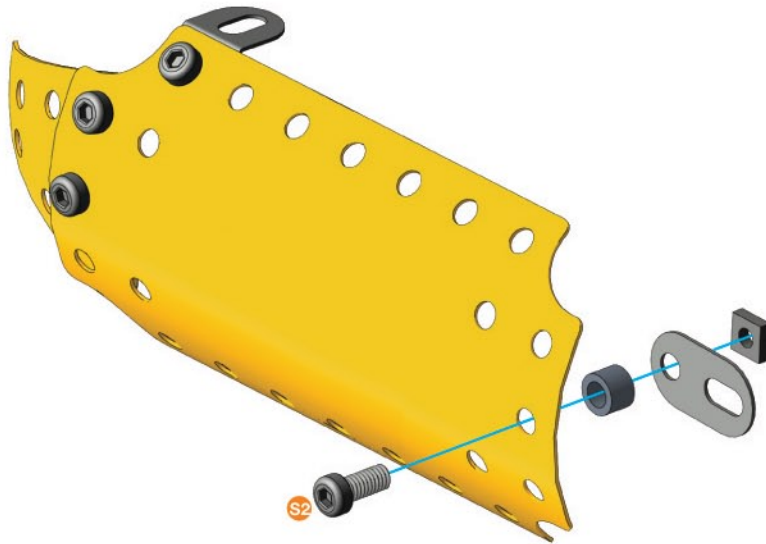

8

	C945 X1
	A338 (0038B) X1
12mm 1/2"	A411 (0111A) X1
	A337 (0037A) X1

	S3	1:1
	A338	

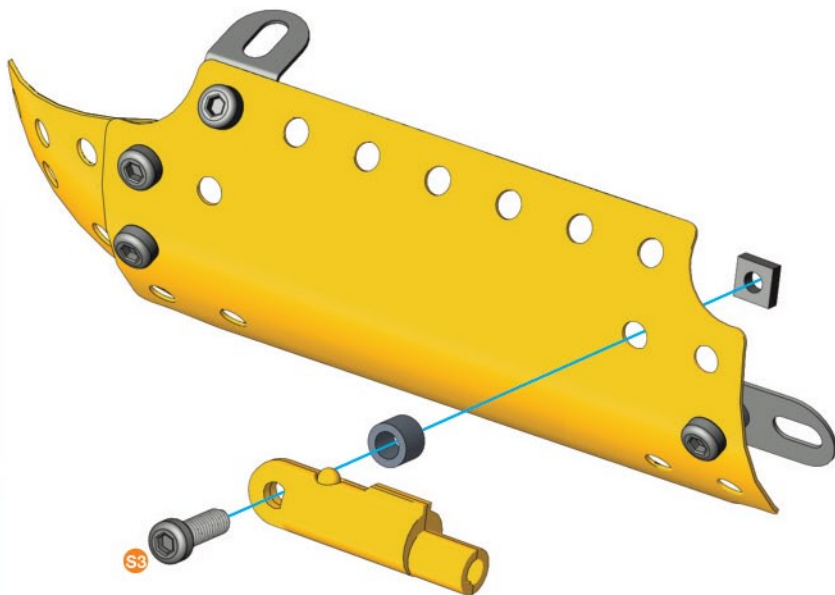

9

A851 (0051G) X1

A637 (0037B) X1
5,8mm / 15/64"

A337 (0037A) X1

S1 **1:1**

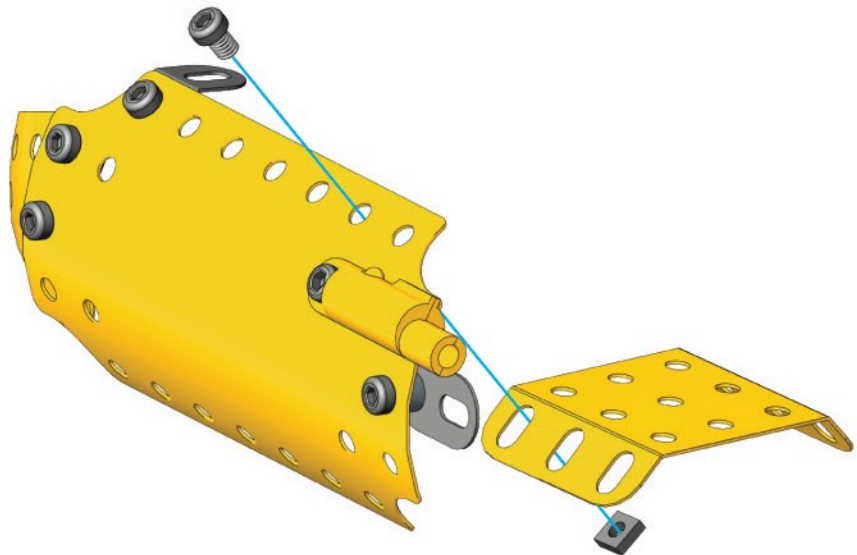

10

8 + 9 +

A637 (0037B) X1
5,8mm / 15/64"

A337 (0037A) X1

S1 **1:1**



11

A851 (0051G) X1

A637 (0037B) X2
5,8mm / 15/64"

A337 (0037A) X2

S1 **1:1**

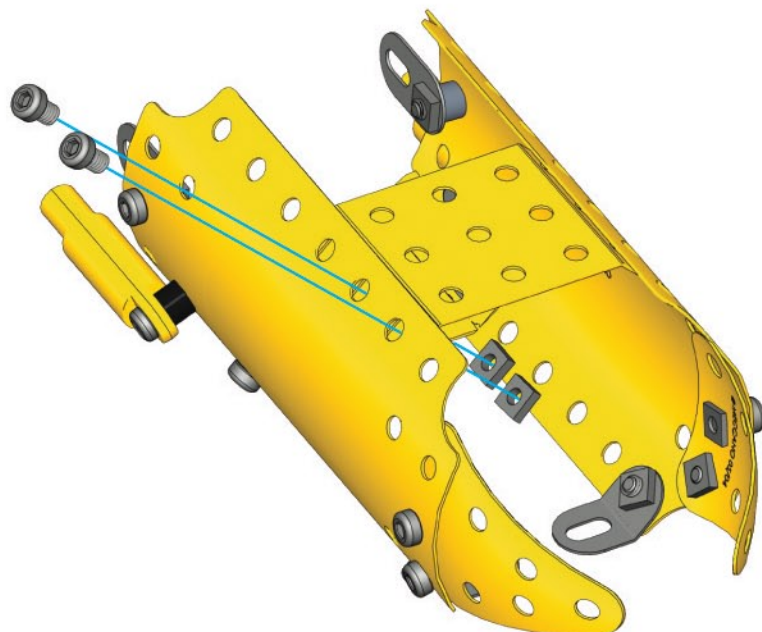

12

S1 5,8mm 15/64" A637 (0037B) X2
A337 (0037A) X2

S1 1:1

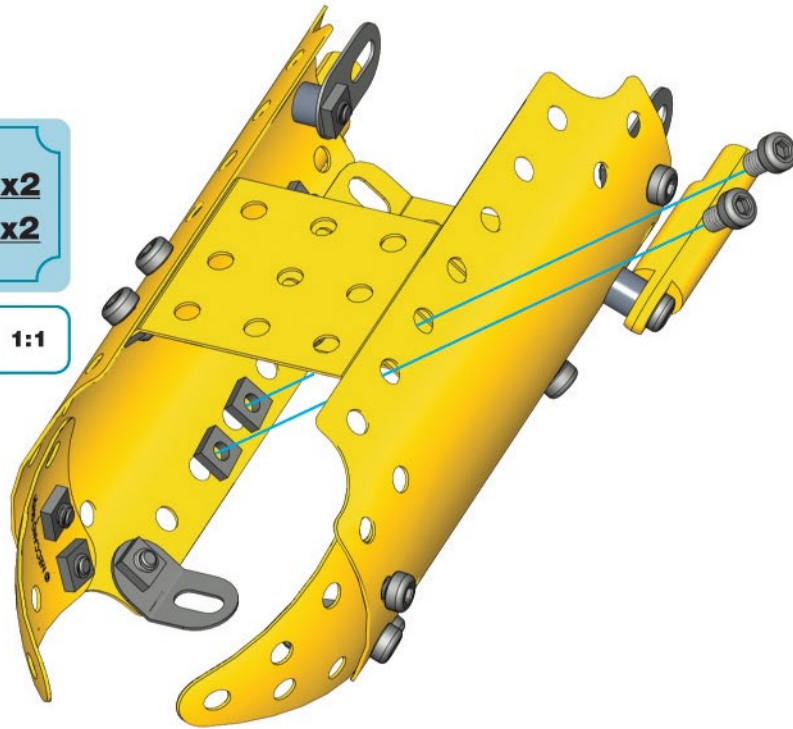

13

C383 X1
A105 (0005) X1
S2 9,5mm 3/8" A511 (0111C) X2
A337 (0037A) X2

S2 1:1

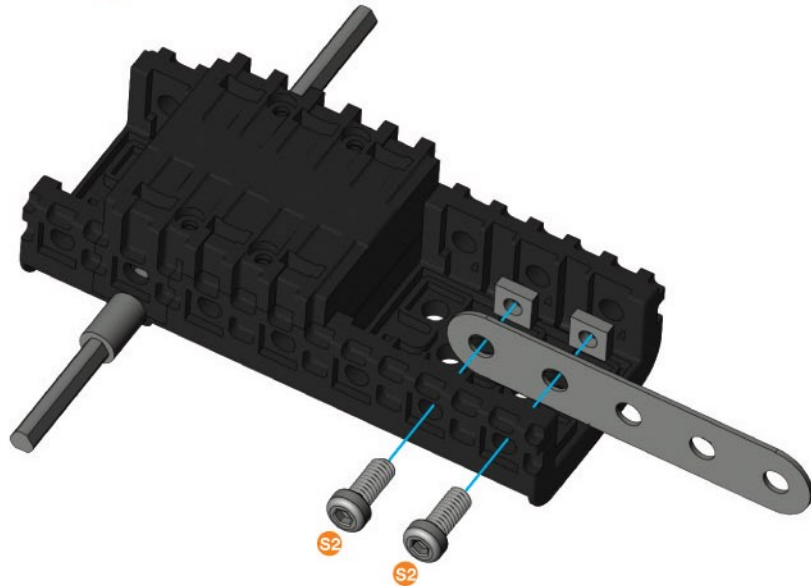

14

A277 (0077) X1
S1 5,8mm 15/64" A637 (0037B) X2
A337 (0037A) X2

S1 1:1

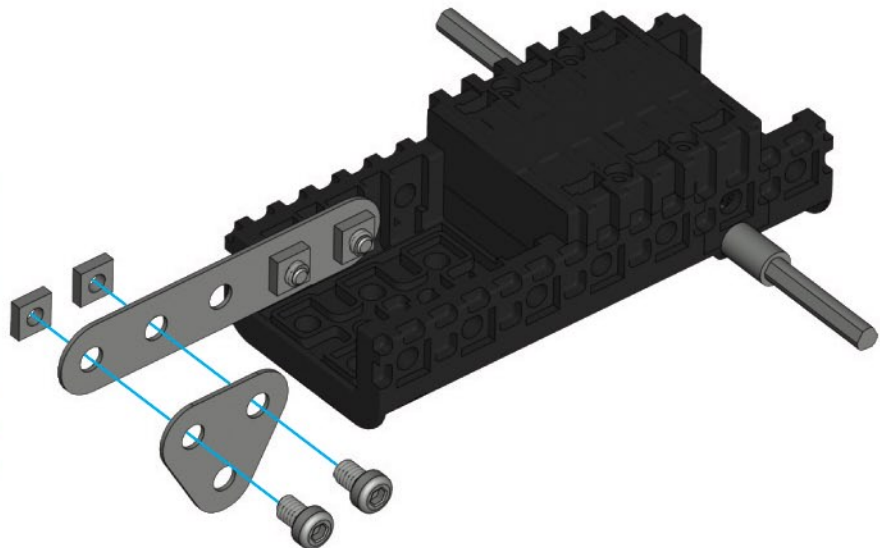

15

A342 (0142K) X1

A626 (0022BP) X1



16 (14) + (15) +

A238 (0038A) X1

B3 2.3mm | **A347 (0147G) X1**

A337 (0037A) X2

B3

A238

1:1

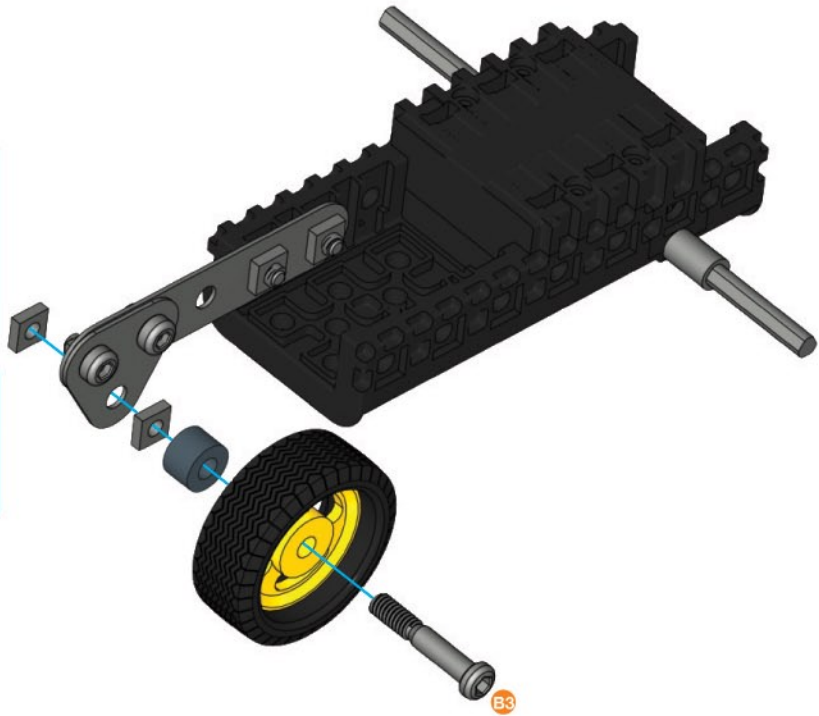

17

A342 (0142K) X2

A322 (0022CP3P) X2



18

16+17+

A623 (0023C3P) X2

A338 (0038B) X4



A338

1:1

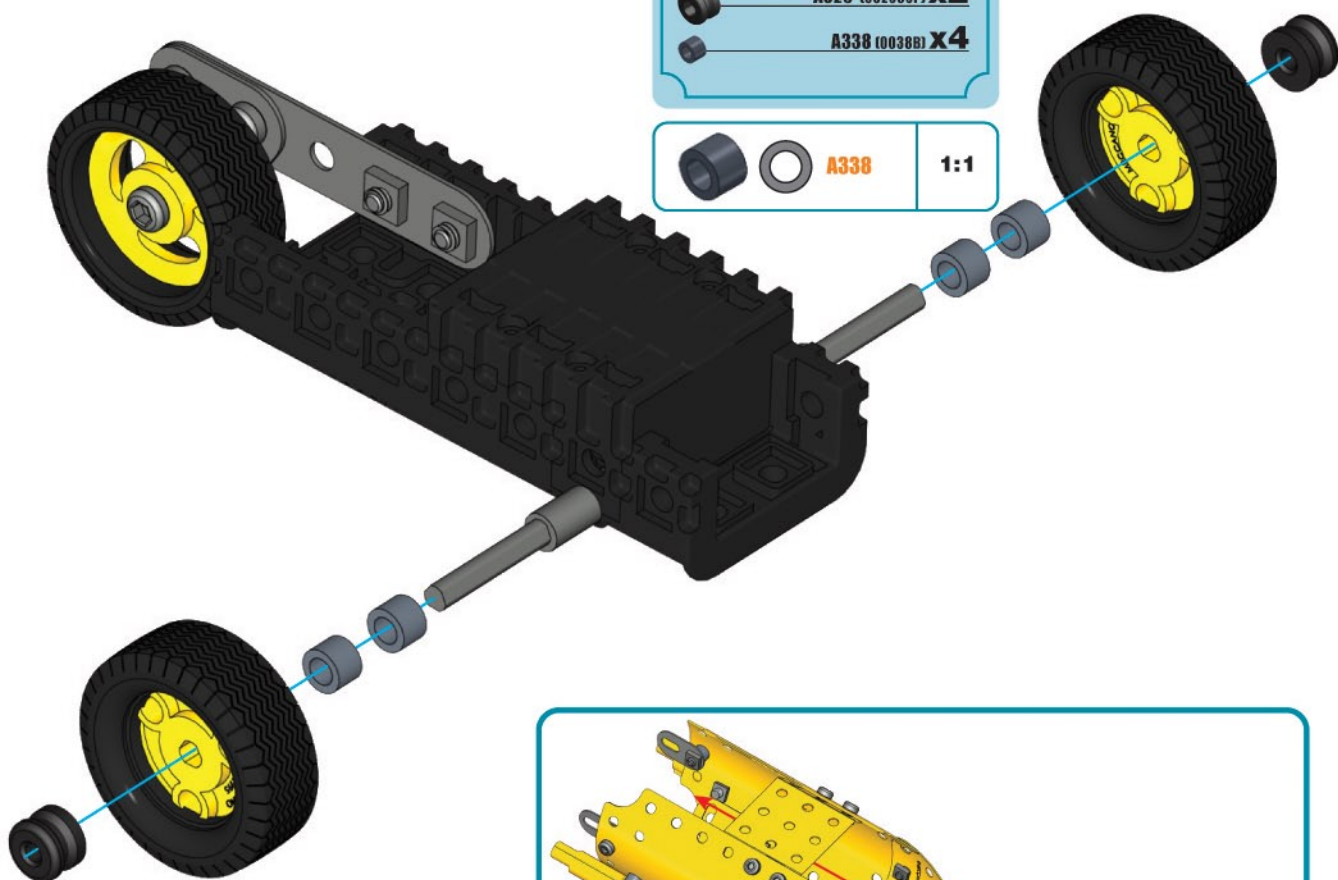

19

12+18+



9,5mm
3/8" A511 (0111C) X1



A337 (0037A) X1



S2 1:1

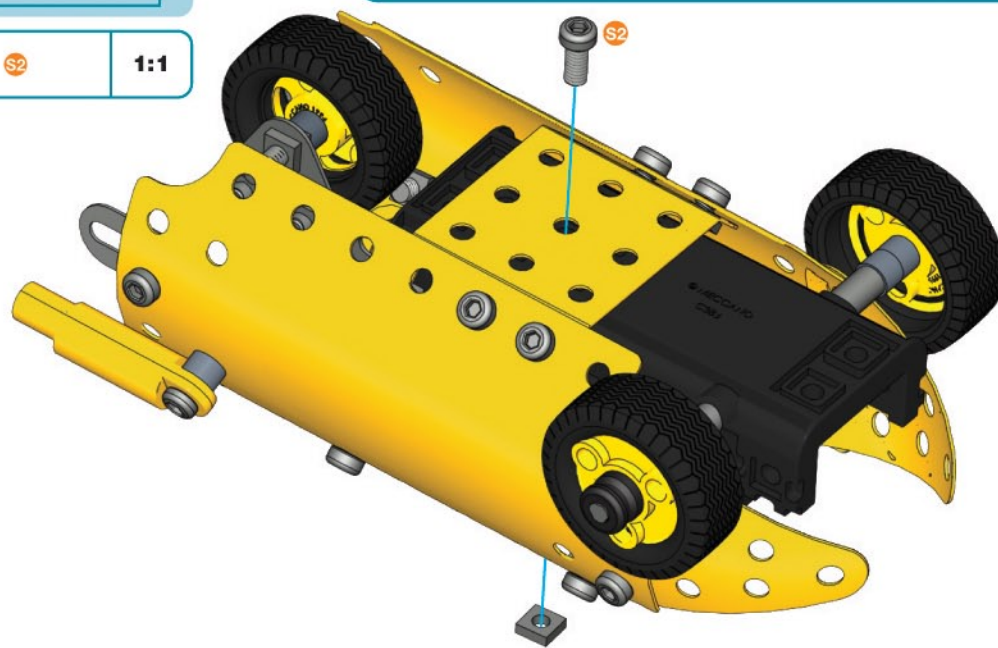
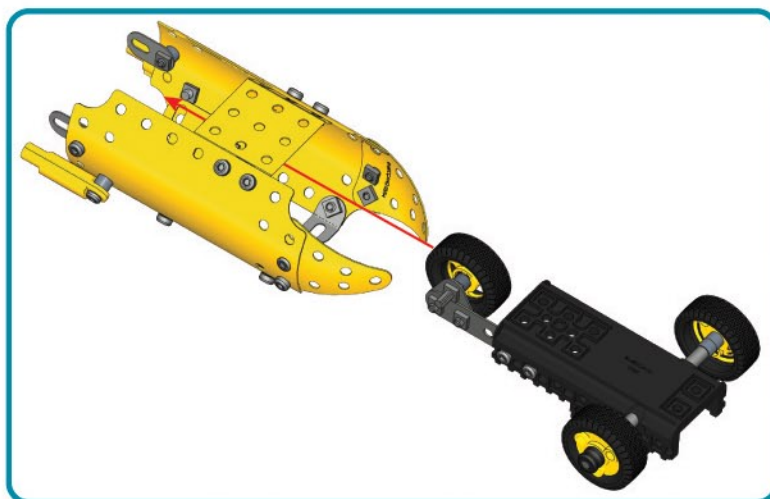

20

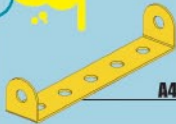

A448 (0048A) X1



A712 (0012C) X2



5,8mm 15/64" A637 (0037B) X1



A337 (0037A) X1



S1

1:1

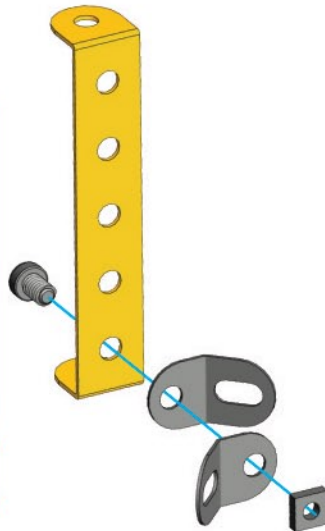

21



A712 (0012C) X2



5,8mm 15/64" A637 (0037B) X1



A337 (0037A) X1



S1

1:1

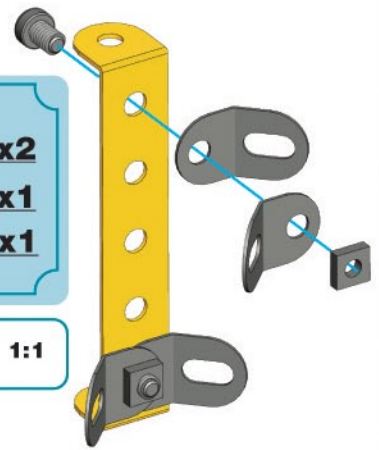

22



A200 (0200) X1



5,8mm 15/64" A637 (0037B) X1



A337 (0037A) X1



A138 (0038) X1



S1

1:1

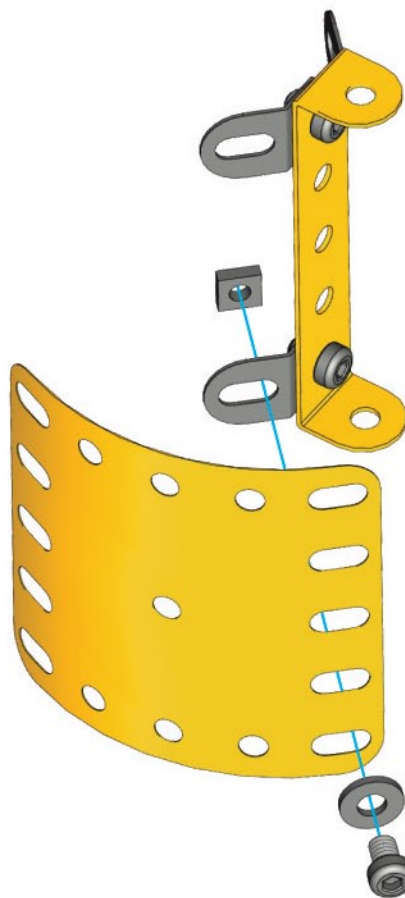

23



5,8mm 15/64" A637 (0037B) X1



A337 (0037A) X1



A138 (0038) X1



S1

1:1

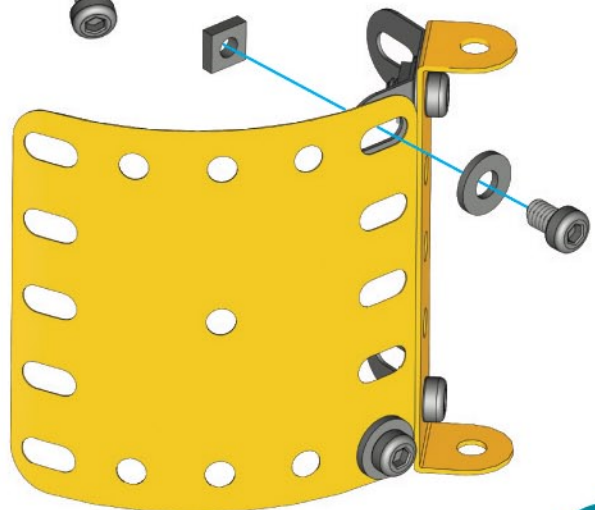

24

	A248 (0048) X 1
5,8mm 15/64"	A637 (0037B) X 1
	A337 (0037A) X 1

	S1	1:1
--	-----------	------------

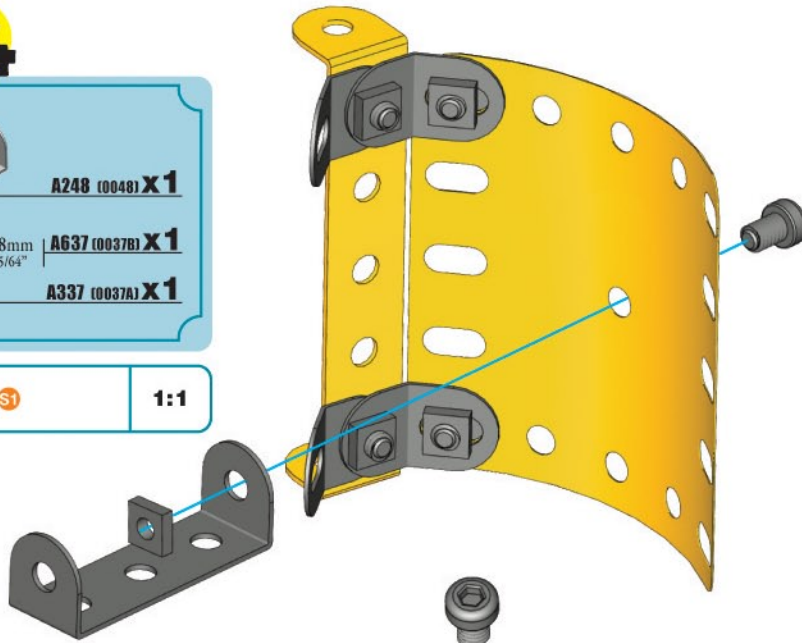

25

	C858 X 1
5,8mm 15/64"	A637 (0037B) X 1
	A337 (0037A) X 1

	S1	1:1
--	-----------	------------

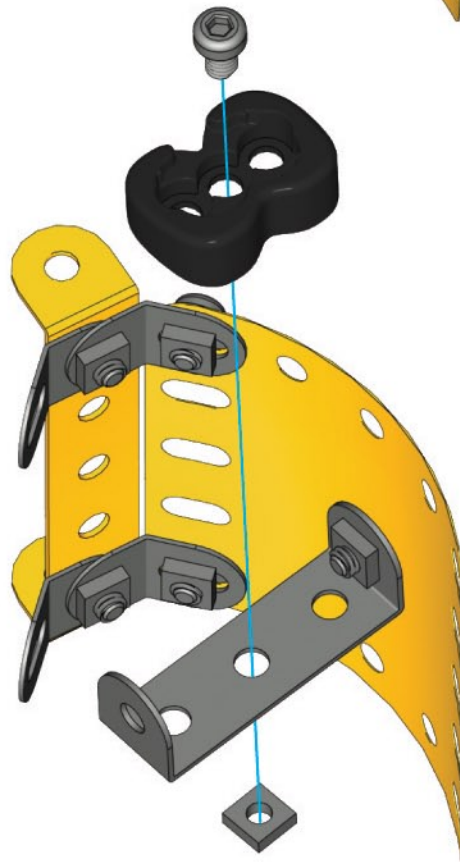

26

	A712 (0012C) X 1
5,8mm 15/64"	A637 (0037B) X 1
	A337 (0037A) X 1
	A138 (0038) X 1

	S1	1:1
--	-----------	------------

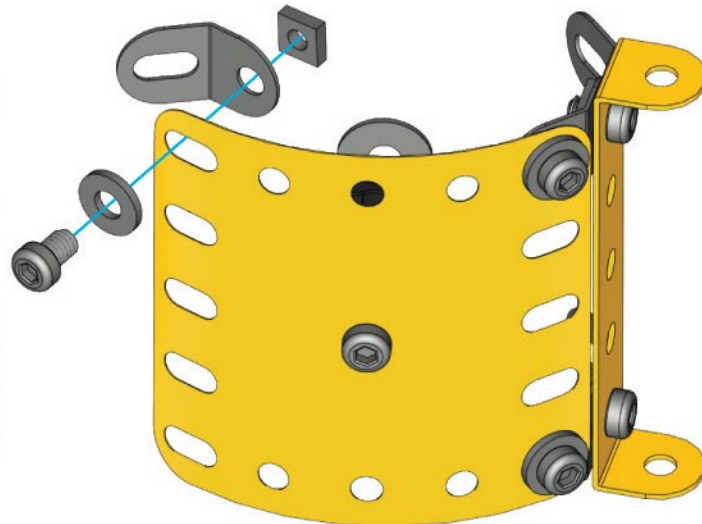

27

-  **A146 (0006) X1**
-  **A712 (0012C) X2**
-  **A637 (0037B) X1**
5,8mm 15/64"
-  **A337 (0037A) X1**

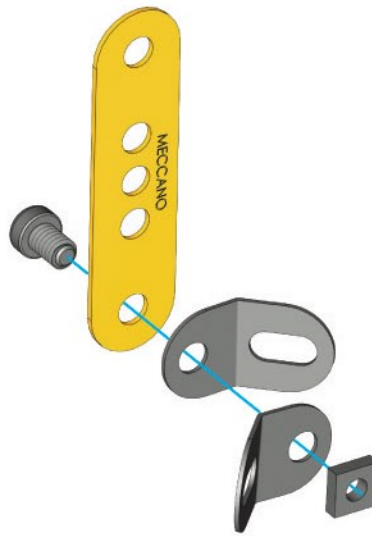

28

-  **A012 (0012) X1**
-  **A712 (0012C) X2**
-  **A637 (0037B) X1**
5,8mm 15/64"
-  **A337 (0037A) X1**

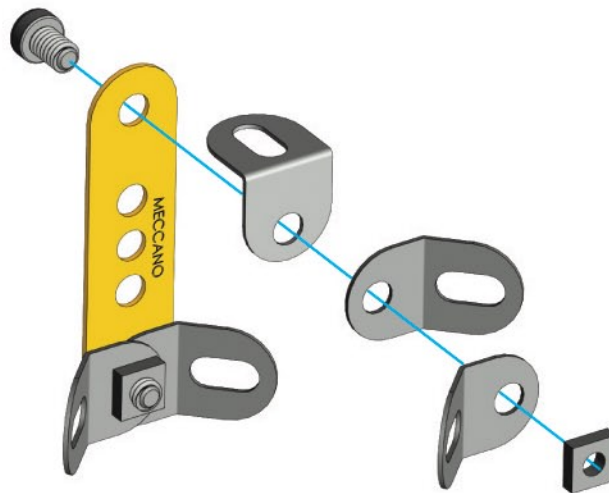

29

26+ 28+

-  **A637 (0037B) X2**
5,8mm 15/64"
-  **A337 (0037A) X2**
-  **A138 (0038) X2**

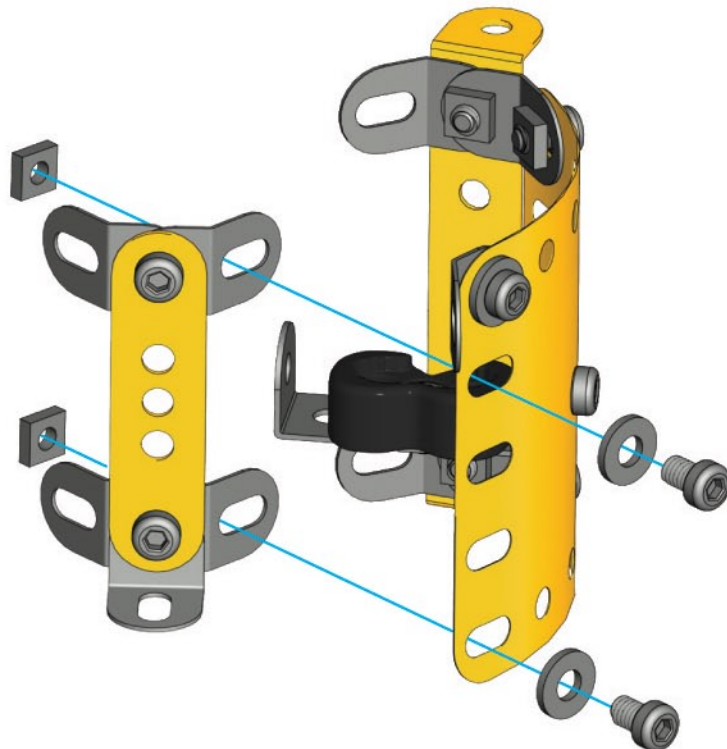

30

	A200 (0200) X 1
	A712 (0012C) X 1
5,8mm 15/64"	A637 (0037B) X 1
	A337 (0037A) X 1
	A138 (0038) X 1

	S1	1:1
--	-----------	------------

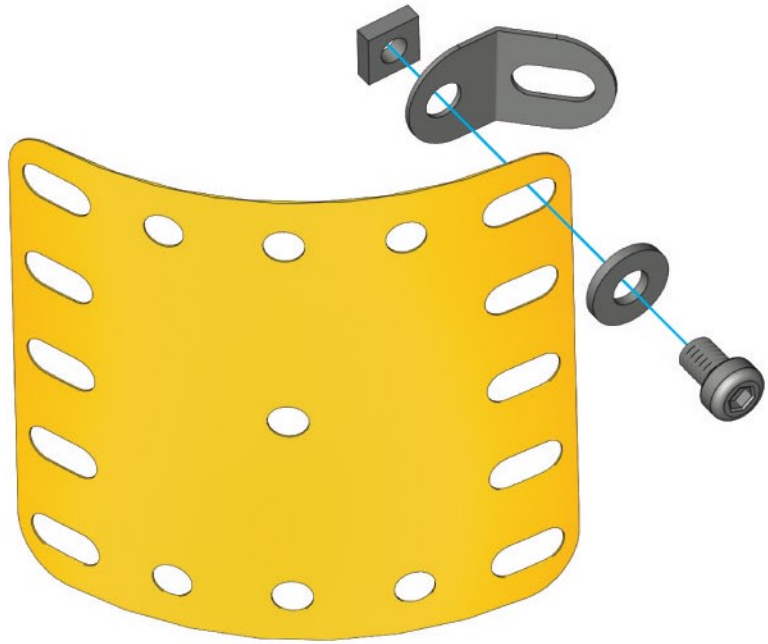

31

29 + 30 +

5,8mm 15/64"	A637 (0037B) X 1
	A337 (0037A) X 1
	A138 (0038) X 1

	S1	1:1
--	-----------	------------

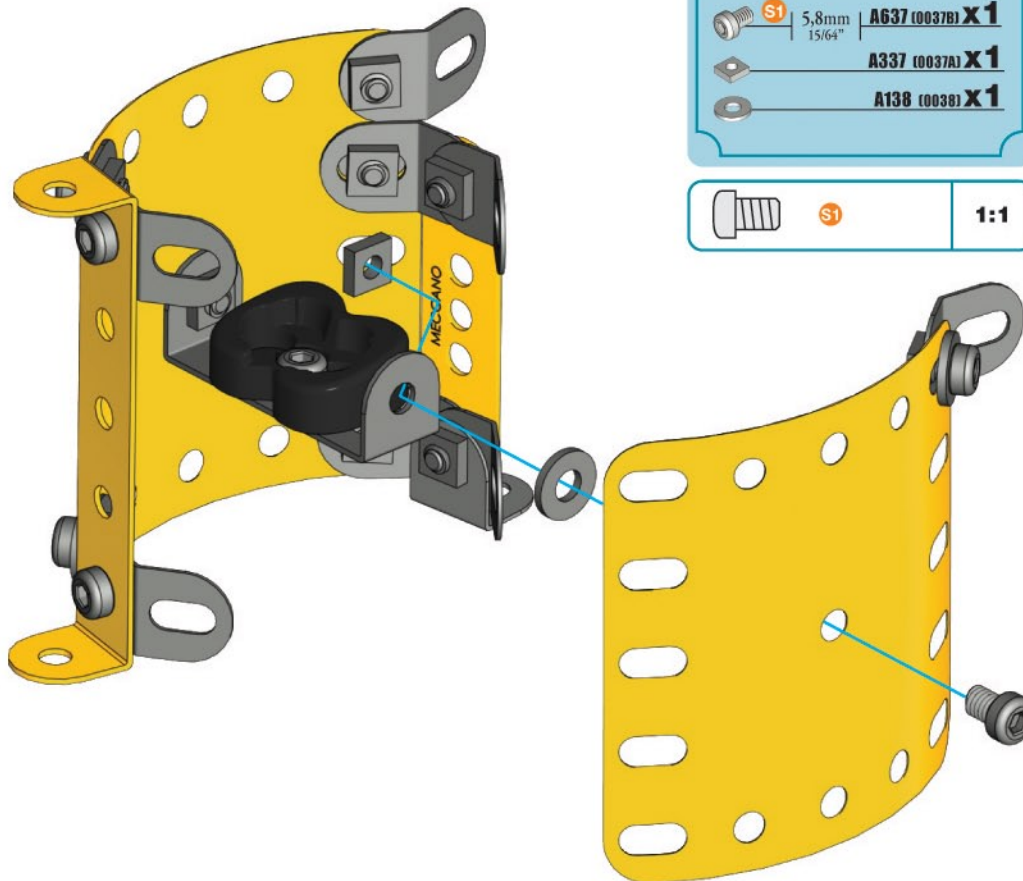

32

 S1	5,8mm 15/64"	A637 (0037B) X2
		A337 (0037A) X2
		A138 (0038) X2

 S1	1:1
--	------------

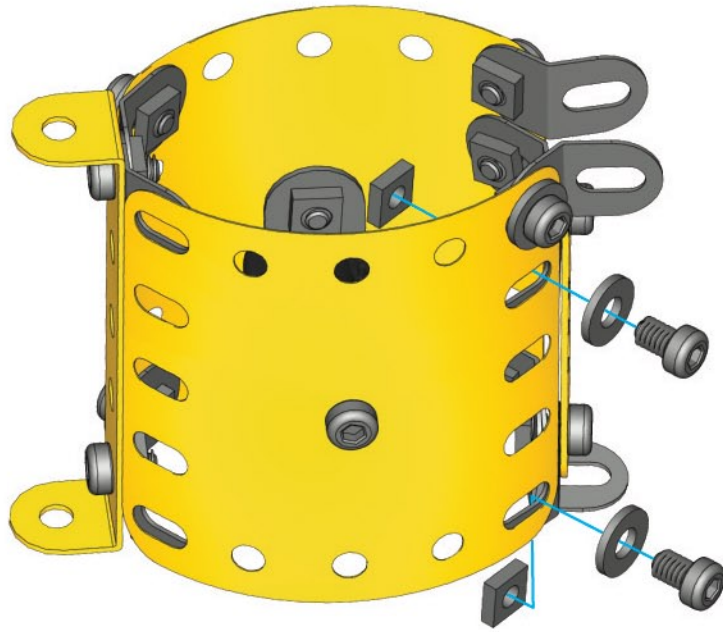

33

 S1	5,8mm 15/64"	A637 (0037B) X2
		A337 (0037A) X2
		A138 (0038) X2

 S1	1:1
--	------------

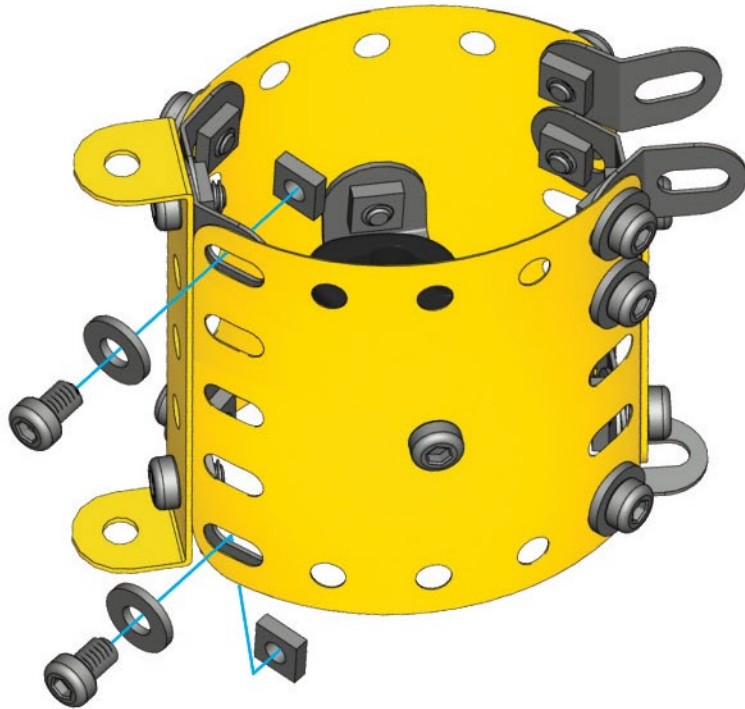

34

		B031 X1
		C863 X1
 S2	9,5mm 3/8"	A511 (0111C) X1

 S2	1:1
--	------------



35

	A545 (03153) X1
---	------------------------



36

33 + 35 +

	A336 (0036B) X2
 23mm 19/32"	A347 (0147G) X1
	A737 (0037H) X1

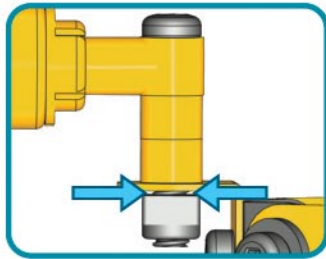
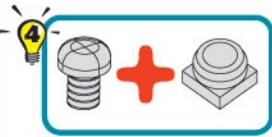

 B3	1:1
--	------------

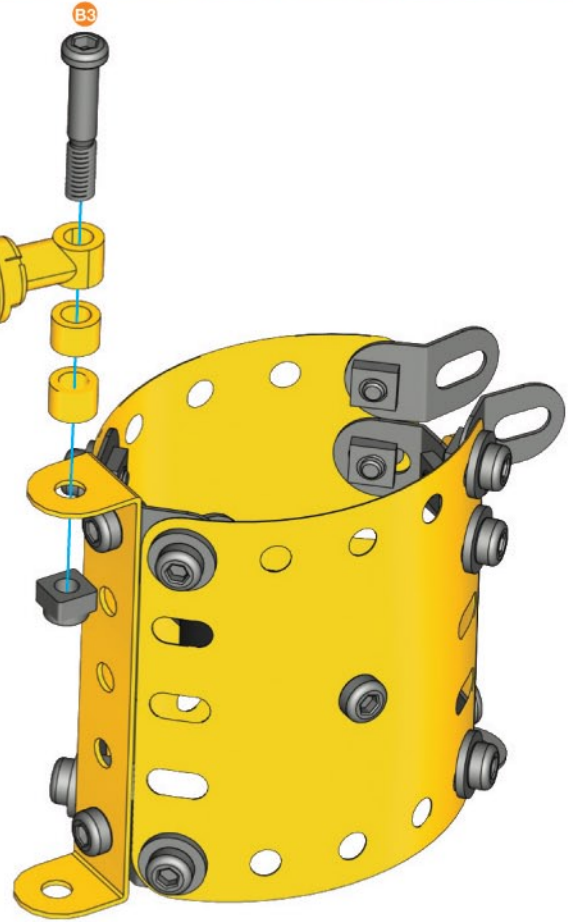

37

	A812 (0812B) X1
	C863 X1
 5,8mm 15/64"	A637 (0037B) X1
	A138 (0038) X1

 S1	1:1
--	------------

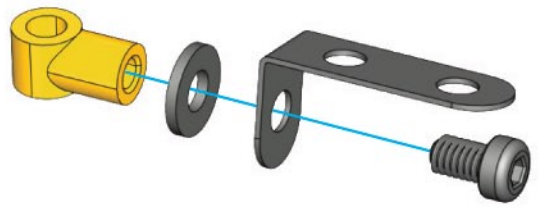

38

	A587 (0187B) X1
	A321 (0321) X1
 23mm 19/32"	A347 (0147G) X1
	A337 (0037A) X1

 B3	1:1
--	------------

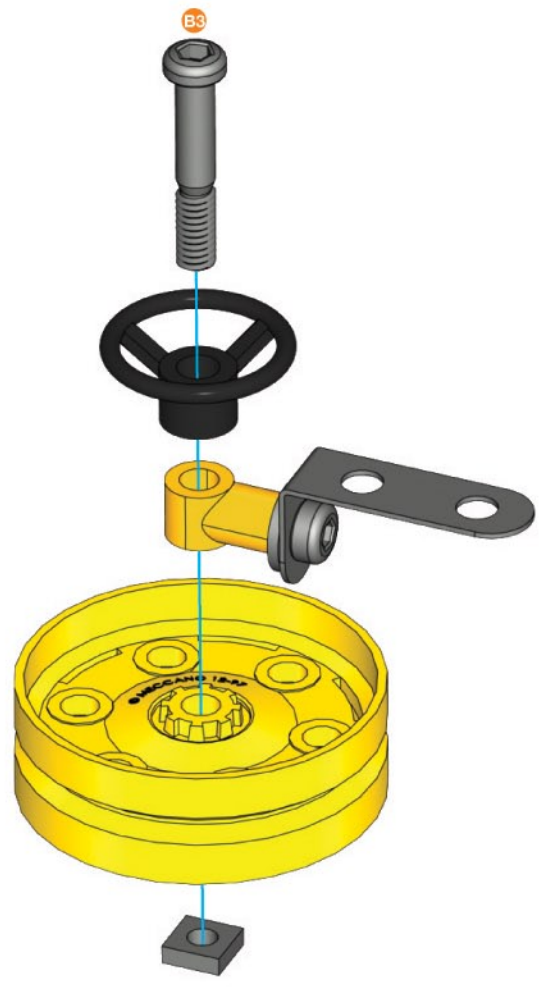

39

C863 X1

S1 5,8mm | **A637 (0037B) X1**
15/64"

A138 (0038) X1

S1 **1:1**

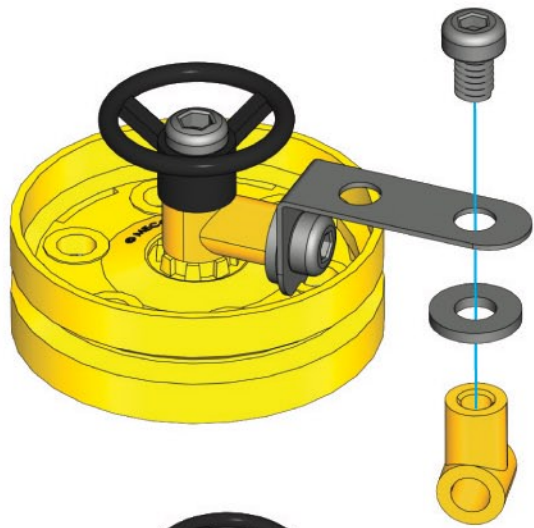

40 **36 + 39 +**

B1 14,7mm | **A247 (0147D) X1**
1/2"

A737 (0037H) X1

A138 (0038) X2

B1 **1:1**

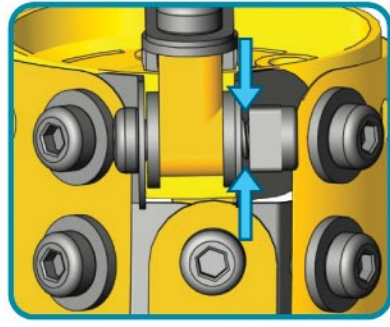
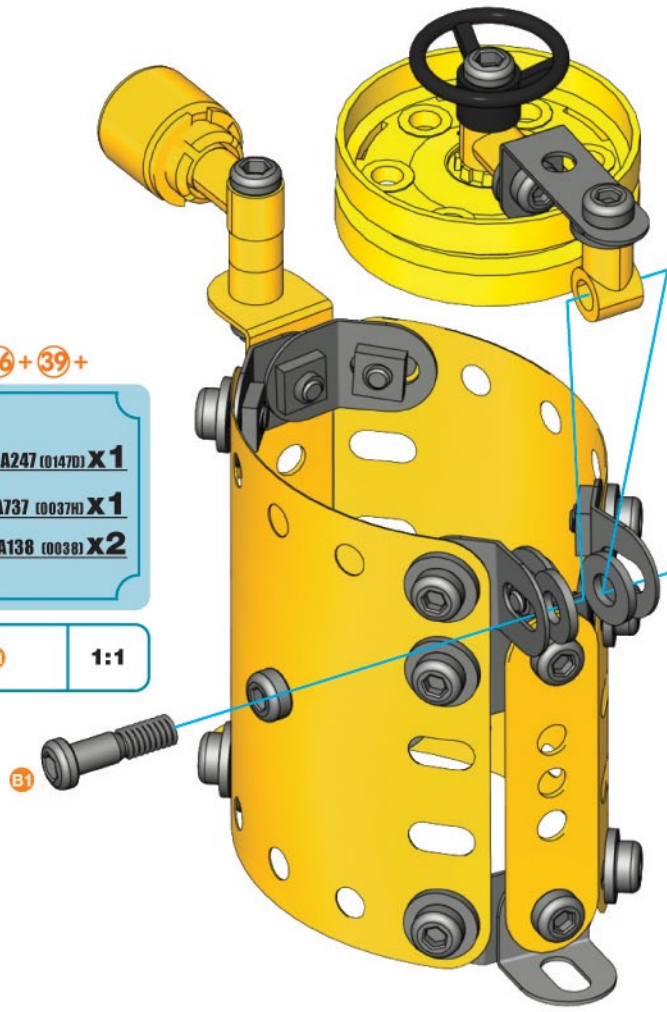

41

A307 (0103H) X1

A336 (0114) X1

S1 5,8mm | **A637 (0037B) X1**
15/64"

A337 (0037A) X1

S1 **1:1**

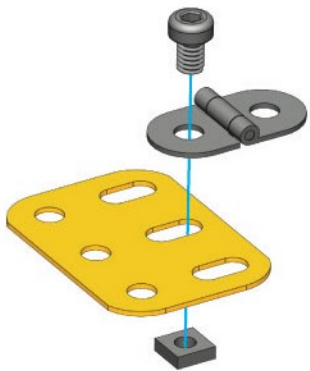

42

(40 + 41) +



S1

5,8mm
15/64"

A637 (0037B) X 1



S1

A337 (0037A) X 1



S1

1:1

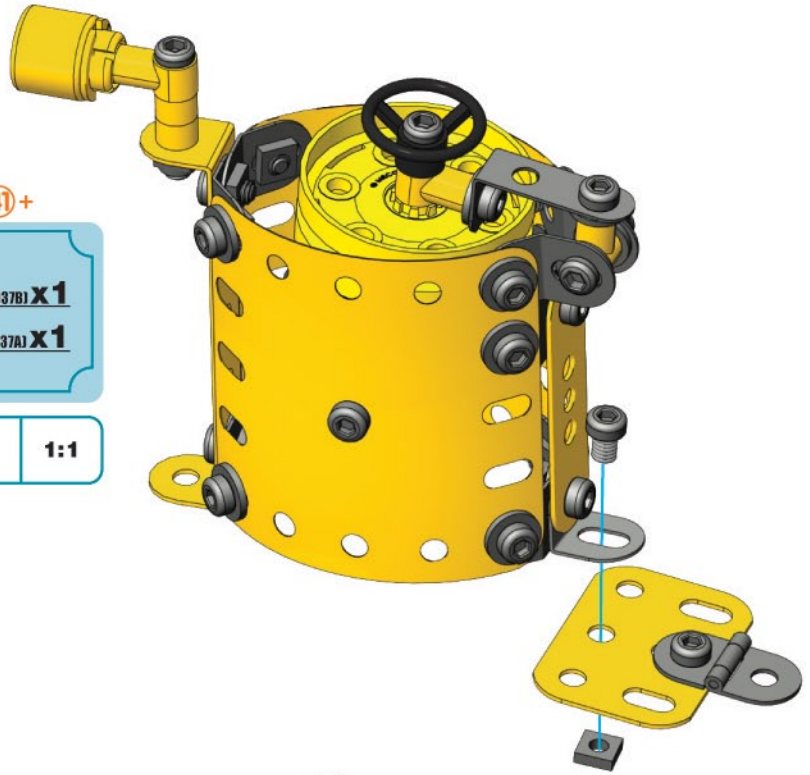

43

(19 + 42) +



S1

5,8mm
15/64"

A637 (0037B) X 1



S1

A337 (0037A) X 1



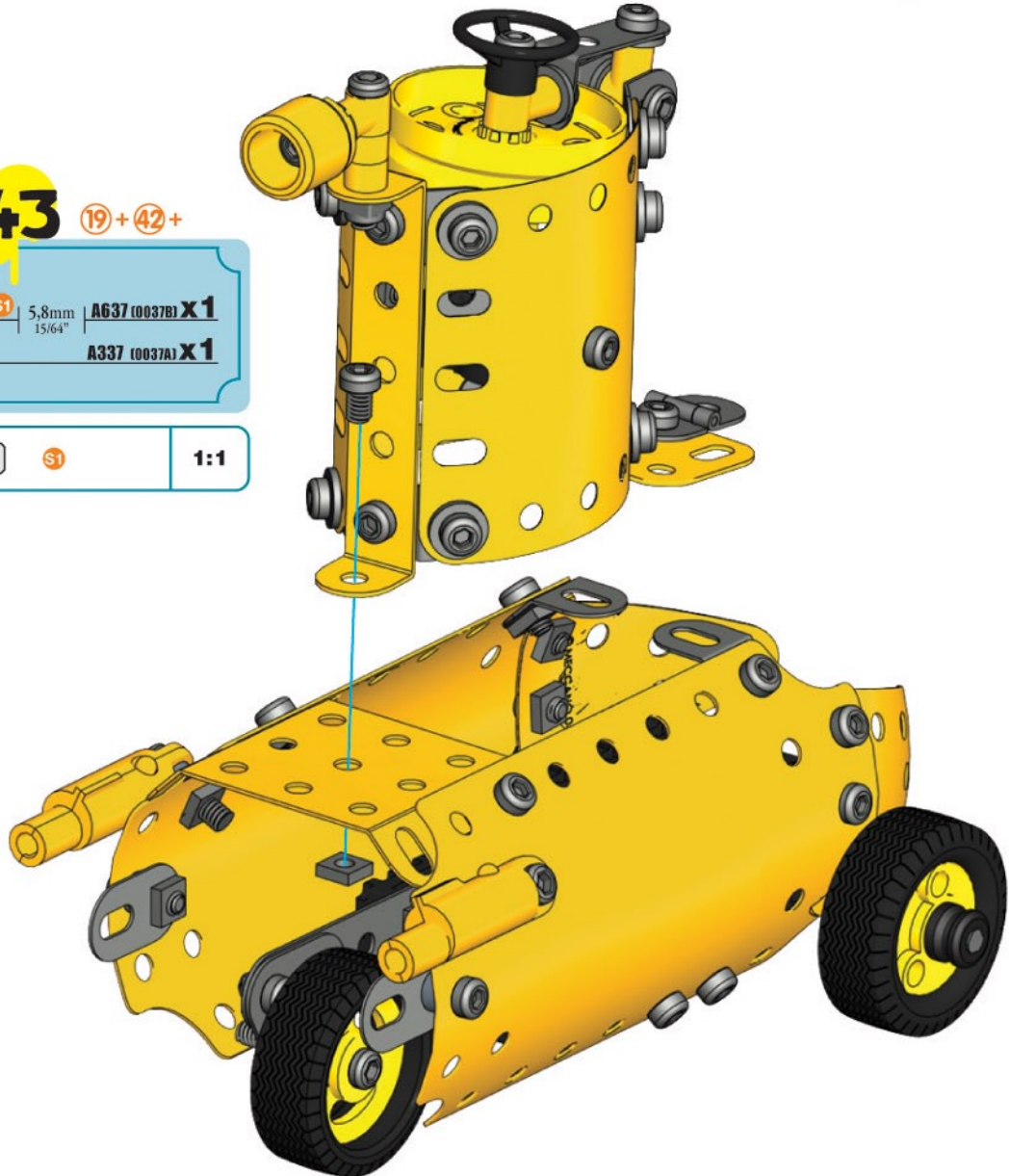

S1

1:1



44

 **S1** 5,8mm 15/64" **A637 (0037B) X2**
 **A337 (0037A) X2**

 **S1** **1:1**

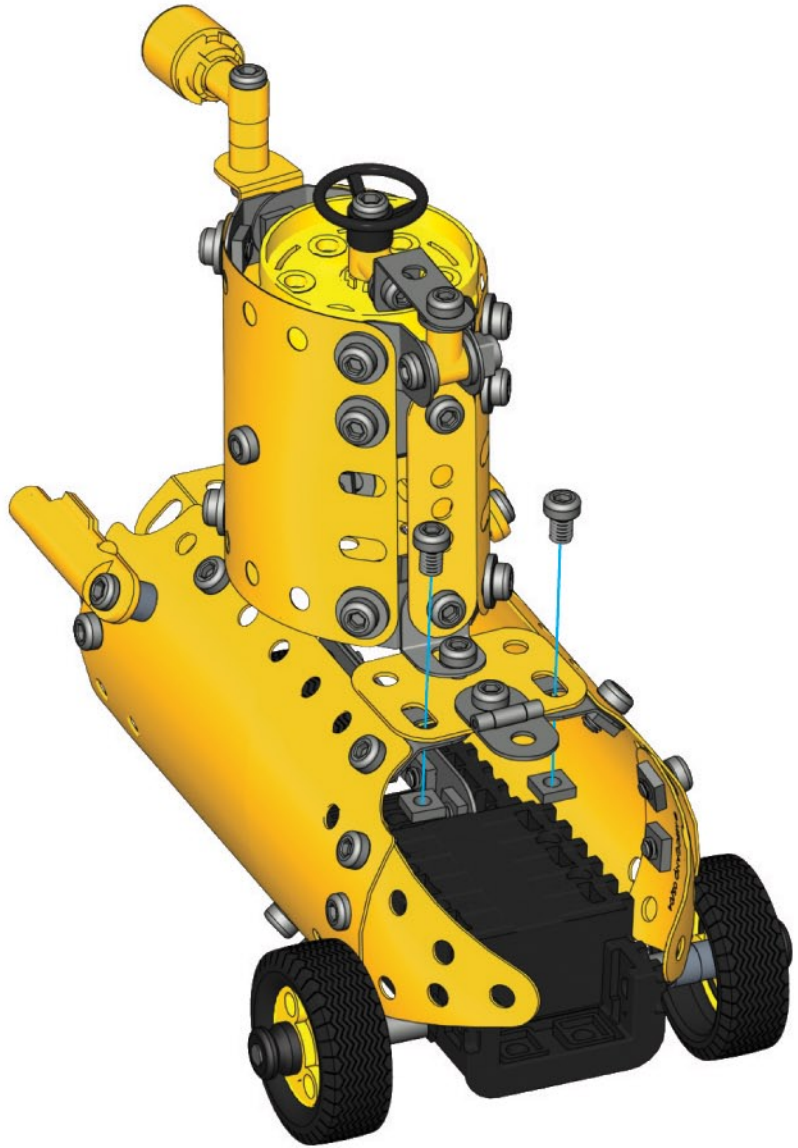

45

C667 X2

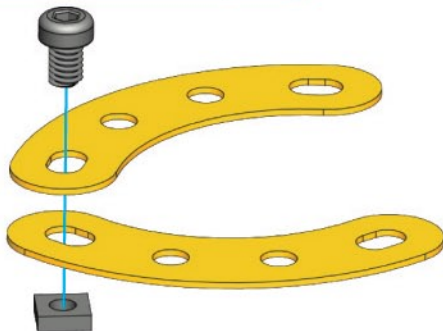

 **S1** 5,8mm 15/64" **A637 (0037B) X1**
 **A337 (0037A) X1**

 **S1** **1:1**



46

A416 (0235G) X1

 **S1** 5,8mm 15/64" **A637 (0037B) X2**
 **A337 (0037A) X2**

 **S1** **1:1**

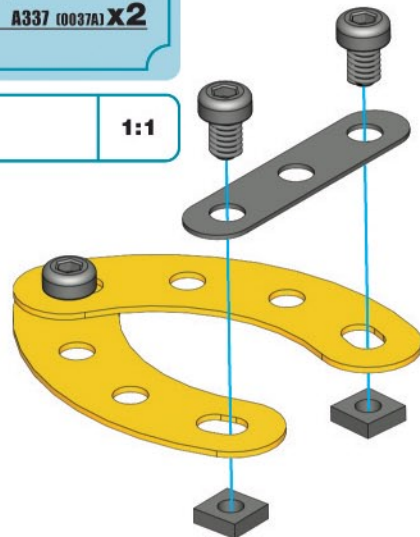

47 44 + 46 +

	5,8mm 15/64"	A637 (0037B) X1
		A337 (0037A) X1

	S1	1:1
---	-----------	------------

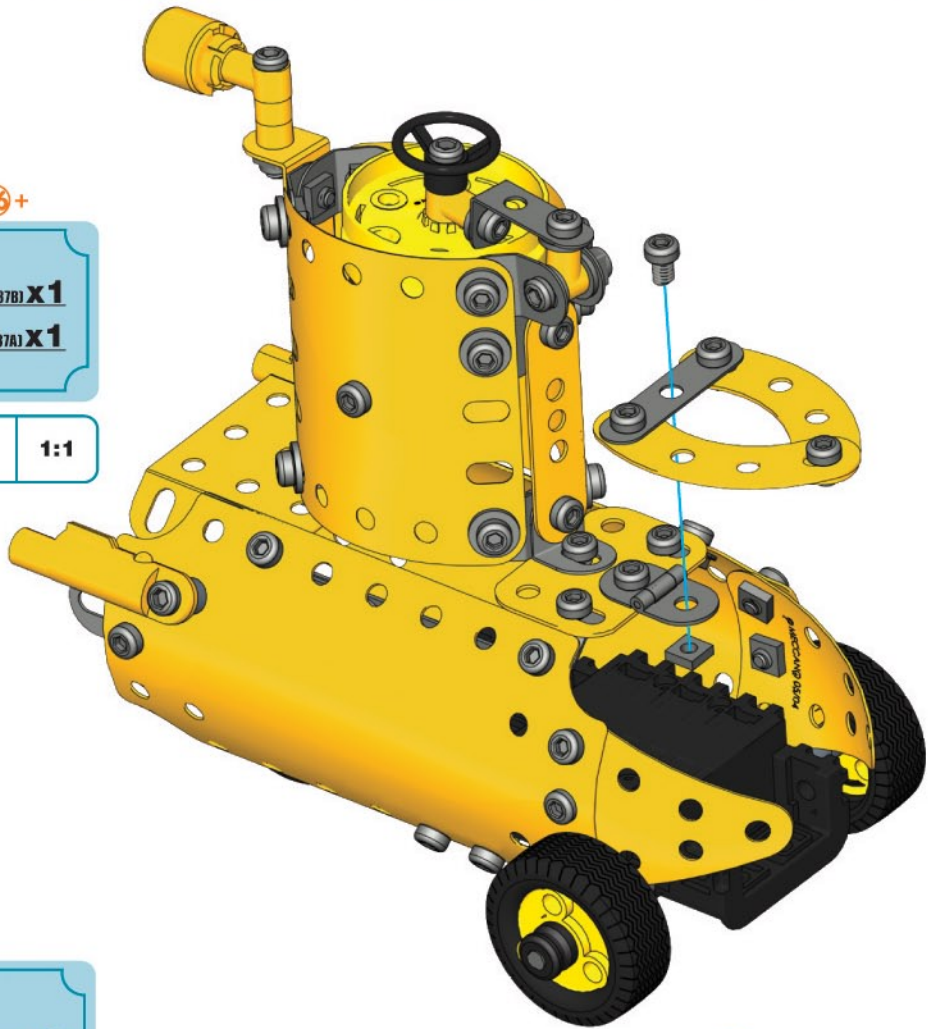



48

		A713 (0012D) X2
		A425 (0260H) X1
		A012 (0012) X2
	12mm 1/2"	A411 (0111A) X1
		A337 (0037A) X1

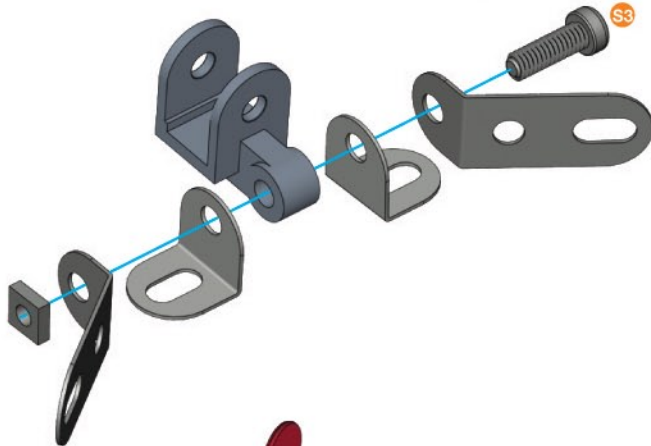
	S3	1:1
---	-----------	------------



49

	32mm 1 1/4"	A430 (0318C) X1
		A041 (0041B) X1
		A338 (0038B) X1
		A259 (0059C) X1

	A338	1:1
---	-------------	------------

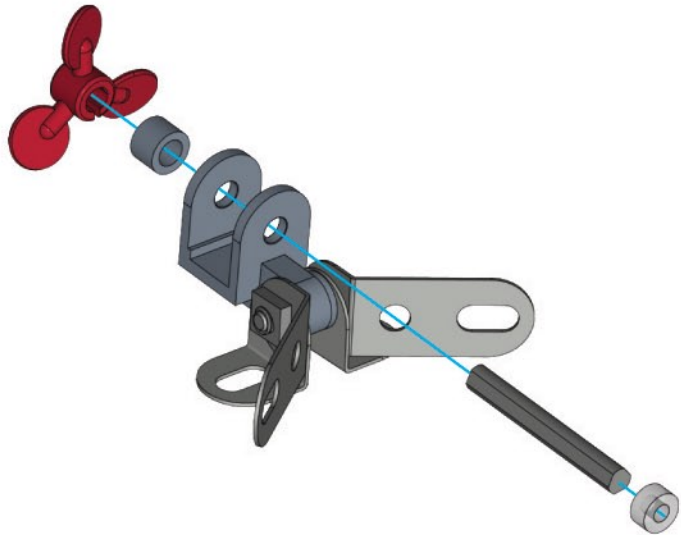

50

	B608 X1
	A012 (0012) X2
	A637 (0037B) X1
	A337 (0037A) X1

	S1	1:1
--	-----------	------------

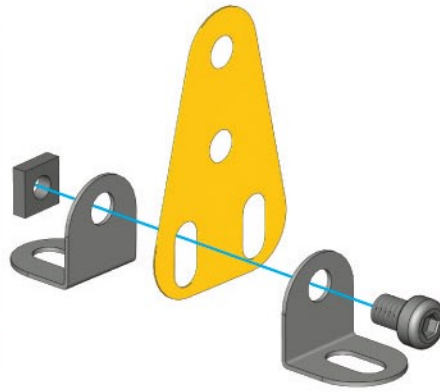

51

	B608 X2
	A637 (0037B) X2
	A337 (0037A) X2

	S1	1:1
--	-----------	------------

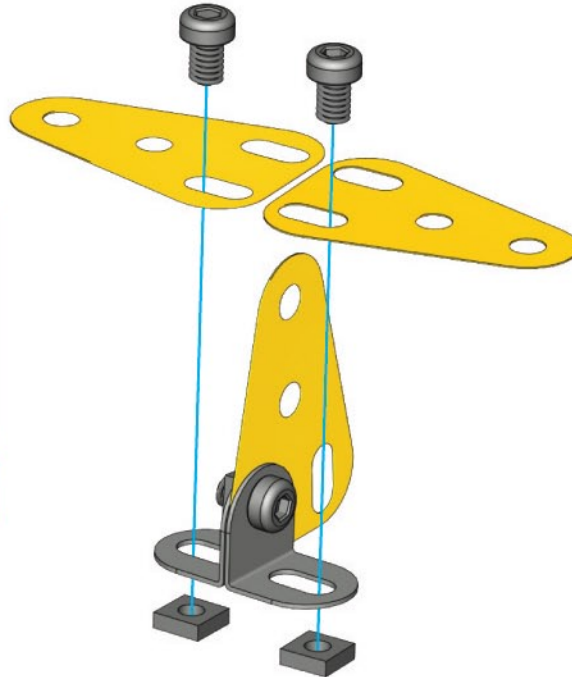

52

	A637 (0037B) X2
	A337 (0037A) X2

	S1	1:1
--	-----------	------------

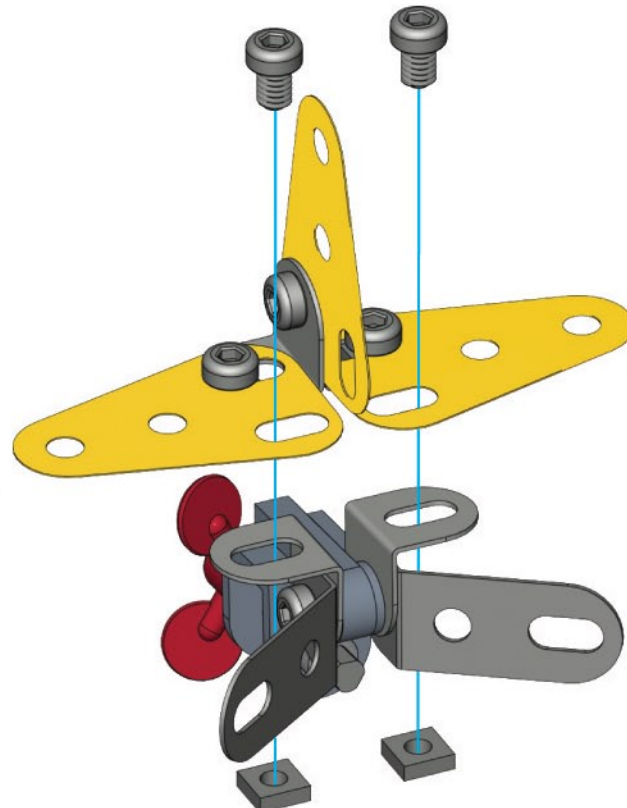

53

47 + 52 +



S1

5,8mm

15/64"

A637 (0037B) X2



A337 (0037A) X2



S1

1:1

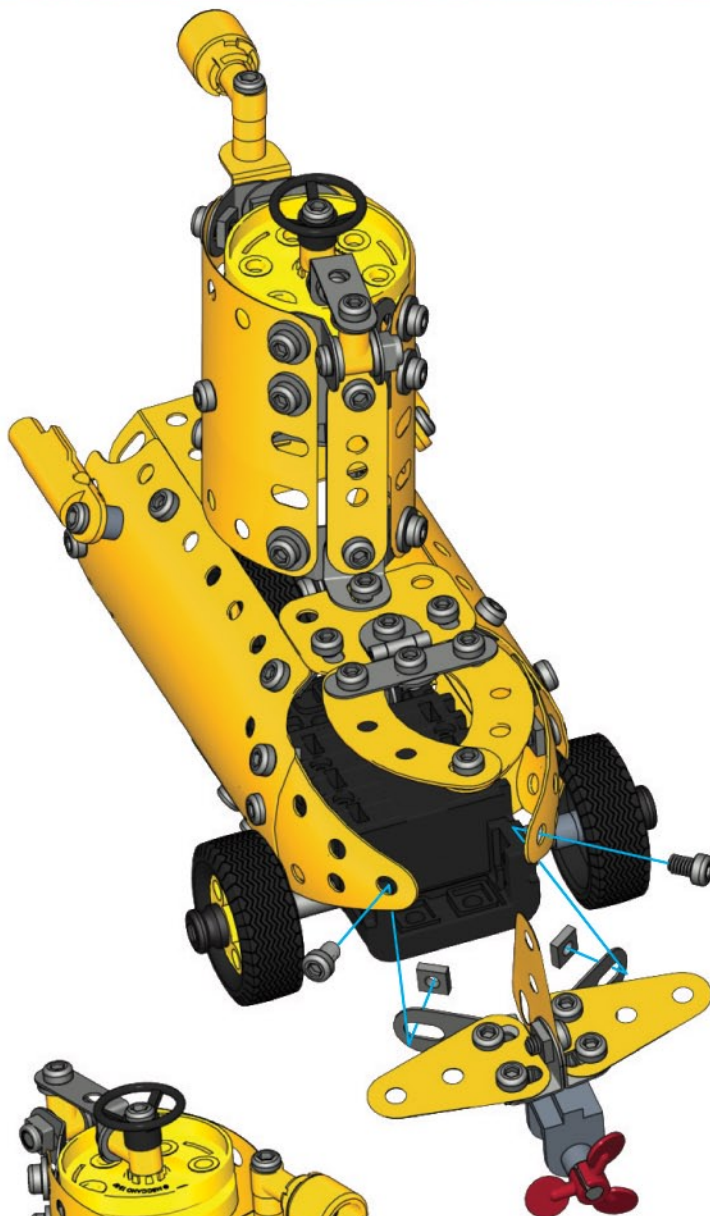

54



75mm

3"

A016 (0016B) X1



B639 X1



A259 (0059C) X2



1:1

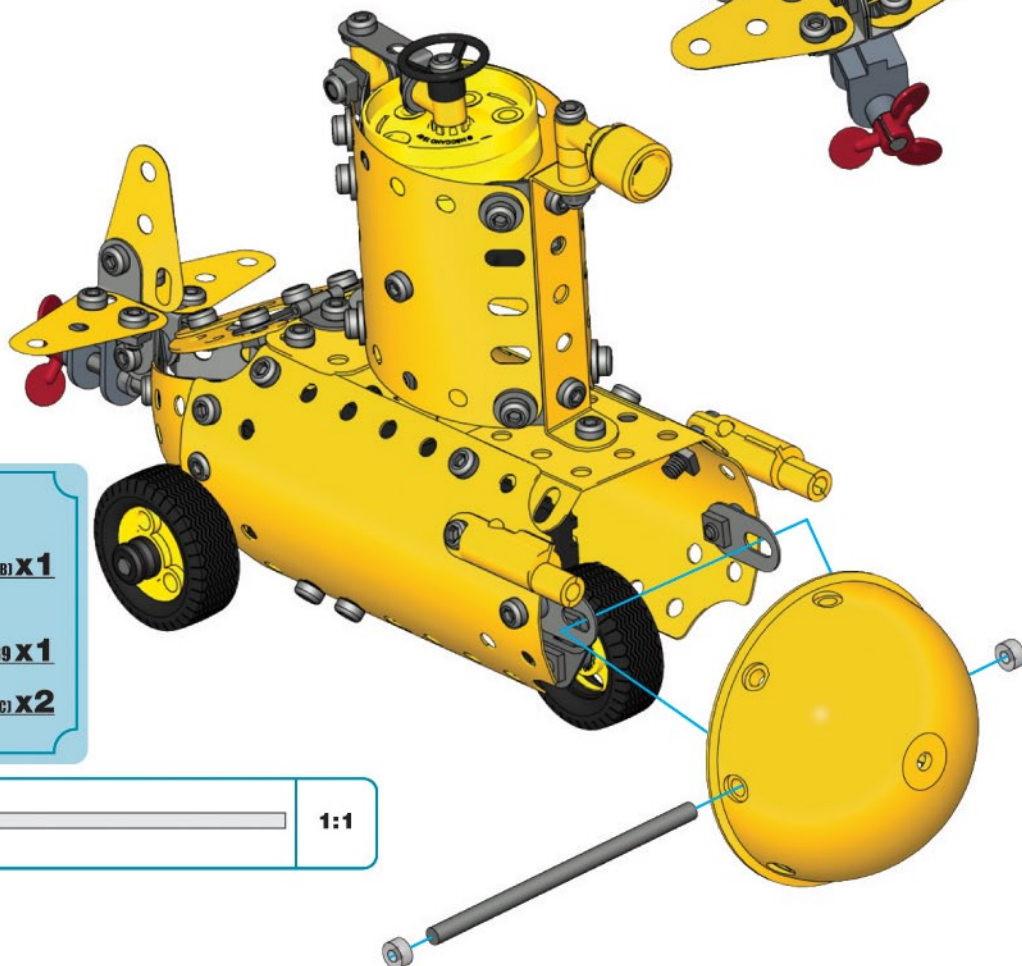

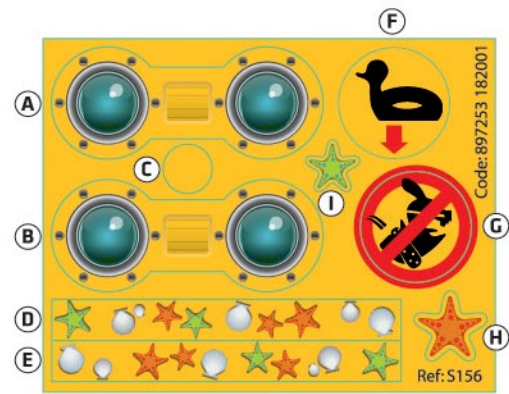

c943 X2

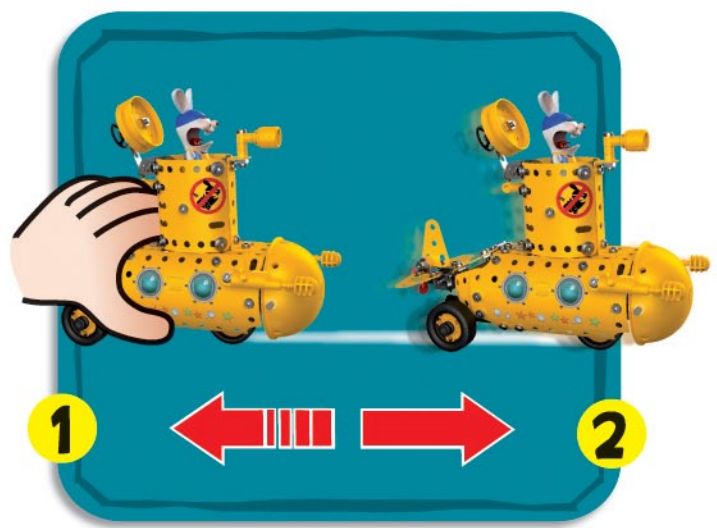
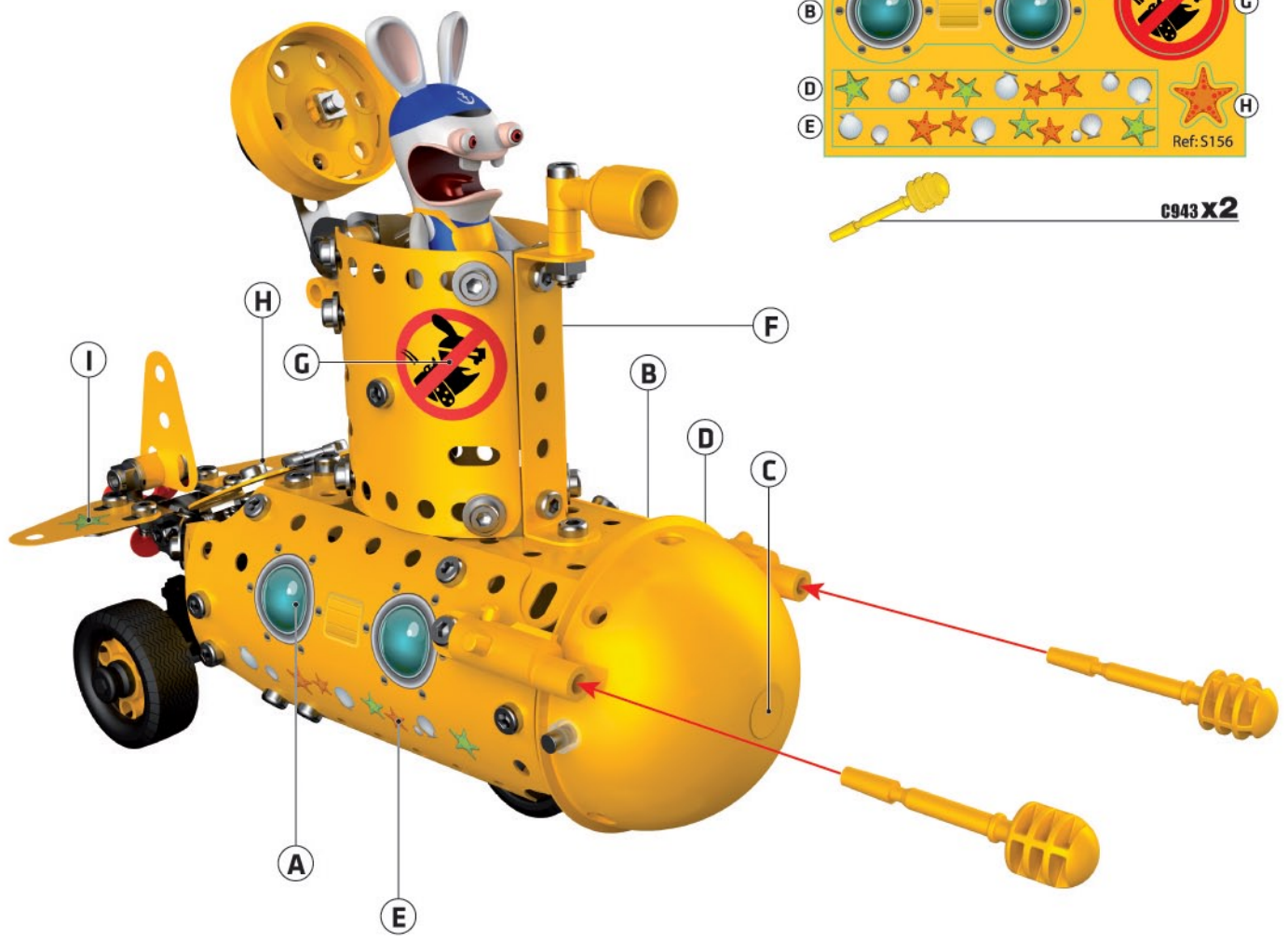

GB USA Many of the models and component parts are unique and original designs which are the property of MECCANO. They are protected by national legislation as industrial designs, trademarks and/or copyrights throughout many countries. For detailed information, please contact: MECCANO. Meccano shall have no responsibility for (I) failure to follow instructions, (II) use of parts for any purpose other than as specified in the instructions (III) any alteration of any parts or components. MECCANO respects children's safety: all models are tested by children.

F De nombreux modèles et pièces sont des créations originales, propriétés de MECCANO et sont protégés par les législations nationales sur les dessins et modèles, marques et/ou droits d'auteurs. Pour toute information, merci de contacter : MECCANO. La responsabilité de MECCANO ne saurait être engagée en cas d'accident survenu à la suite (I) du non respect des instructions de montage (II) d'une utilisation des pièces autre que celle proposée dans la notice (III) d'une altération ou de la modification des pièces. La société MECCANO respecte la sécurité des enfants : ses modèles sont testés par des enfants.

D Zahlreiche Modelle und Teile sind Erfindungen und Eigentum der Firma MECCANO. Sie sind durch Inland-Gesetze über Zeichnungen und Modelle sowie Warenzeichen und/oder Urheberrechte geschützt! Für zusätzliche Auskünfte wenden Sie sich bitte an : MECCANO. Die Firma Meccano haftet nicht für Unfälle, die aus der (I) Nichtbeachtung der Bauanleitung, der (II) Verwendung anderer als in der Bauanleitung angegebenen Teile oder der (III) Änderung oder Modifikation der Teile resultieren. Alle Modelle der Firma Meccano wurden von Kindern getestet und entsprechen den Sicherheitsnormen.

I Numerosi modelli e pezzi sono creazioni originali della MECCANO e sono protetti dalle legislazioni nazionali sui disegni e modelli, marche e/o diritti d'autore. Per qualsiasi informazione, vi potete prendere contatto con : MECCANO. Meccano declina ogni responsabilità in caso d'incidenti sopravvenuti in seguito (I) a non rispetto delle istruzioni di montaggio (II) utilizzo dei pezzi per funzioni diverse da quelle previste nel manuale (III) alterazione e/o modifica dei pezzi. La società MECCANO rispetta la sicurezza dei bambini : i suoi modelli vengono testati dai bambini stessi.

E Numerosos modelos y piezas son creaciones originales, propiedades de MECCANO y están protegidos por las legislaciones nacionales en lo que concierne a los dibujos y modelos, marcas y/o derechos de autor. Para cualquier información, sírvase ponerse en contacto con : MECCANO. MECCANO carece de responsabilidad en caso de accidente debido a: (I) el incumplimiento de las instrucciones de montaje (II) una utilización de las piezas diferente a la que se indica en las instrucciones (III) una alteración o modificación de las piezas. La sociedad MECCANO respeta la seguridad de los niños : sus modelos están probados por niños.

P Vários modelos e peças são criações originais, propriedades da MECCANO e são protegidos pelas legislações nacionais relativas aos desenhos e modelos às marcas e/ou aos direitos de autor. Para qualquer informação, é favor contactar : MECCANO. A Sociedade MECCANO não poderá ser responsabilizada pelos acidentes provocados: (I) pela falta de cumprimento das instruções de montagem (II) pelo uso indevido das peças ou (III) pela modificação ou alteração das peças. A Sociedade MECCANO respeita a segurança das crianças : os seus modelos foram testados por crianças.

S Många modeller och delar bildar en unik och originell formgivning vilken är MECCANO egendom. Dessa modeller och delar är skyddade genom lagstiftning såsom industriell formgivning, varumärke och/eller upphovsmanrätt i ett flertal länder. För mer detaljerad information, var vänlig och kontakta MECCANO. MECCANO främlar sig allt ansvar i händelse av olycka till följd av (I) att monteringsinstruktionerna inte har respekterats (II) en annan användning av delarna än den som står i anvisningen (III) en förvanskning eller förändring av delarna. Företaget MECCANO respekterar barnsäkerheten : modellerna har testats av barn.

FIN Useat mallit ja osat ovat MECCANO: n omaisuutta olevaa alkuperäistä suunnittelua. Ne ovat kansallisilla lailla suojattua teollista tuotantoa, tavaramerkkejä ja/tai kopiointioikeuksia. Pyydämme ottamaan yhteyden MECCANO: han kaikissa asioissa liittyvissä kysymyksissä. MECCANO ei vastaa eikä kata seuraavista syistä sattuneita onnettomuuksia: (I) ohjeiden vastainen kokoaminen, (II) muiden kuin ohjeissa ehdotettujen osien käyttö, (III) osien muuttelu tai eri tarkoitukseen käyttö. MECCANO-yhtiö huolehtii lasten turvallisuudesta: lapset ovat testanneet mallimme.

DK Vore mange modeller og dele er originale fremstillinger og ejes af MECCANO. Tegninger, modeller, fabrikkationsmærker og ophavsret er lovbeskyttede i hvert land. Yderligere oplysninger kan fås hos: MECCANO. MECCANO frasiger sig ethvert ansvar, såfremt der er sket uheld forårsaget af (I) at monteringsinstruktionerne ikke er blevet overholdt, (II) at delene er blevet brugt til andre formål, end dem der er beskrevet i betjeningsvejledningen, (III) eller at delene er blevet beskadiget eller ændret, MECCANO overholder sikkerhedsreglerne for børn: Alle modeller testes af børn.

NL Veel modellen en onderdelen zijn originele ontwerpen en eigendom van MECCANO en worden beschermd door de nationale wetgeving en tekening en modellen, merken en/of auteursrechten. Voor informatie gelieve contact op te nemen met MECCANO. De verantwoordelijkheid van MECCANO is uitgesloten in geval van ongevallen voortkomend uit het naleven van de montage-instructies (I), uit het gebruik van andere onderdelen dan die zoals vermeld in de handleiding (II) of uit het veranderen of modificeren van de onderdelen (III). De firma MECCANO neemt de veiligheid van de kinderen in acht : de modellen zijn door kinderen getest.

GR Πολλά μοντέλα και ανταλλακτικά είναι αυθεντικά, ιδιοκτησία της MECCANO και προστατεύονται από τις εθνικές νομοθεσίες για τα μοντέλα τις μάρκες, ή τα διπλώματα ευρεσιτεχνίας. Για κάθε πληροφορία για κάθε πληροφορία παρακαλώ απευθυνθείτε στη MECCANO. Η ευθύνη της MECCANO δεν δεσμεύεται σε περίπτωση ατυχήματος που έγινε συνέχεια (I) μη σεβασμού των οδηγιών συναρμολόγησης (II) χρήσης των τεμαχίων διαφορετική από αυτήν που προτείνεται στις οδηγίες (III) καταστροφή ή αλλαγή των τεμαχίων. Η εταιρεία MECCANO σέβεται την ασφάλεια των παιδιών: τα μοντέλα της δοκιμάζονται από παιδιά.

RUS Многие модели и детали набора являются уникальными. Их оригинальная концепция является собственностью компании MECCANO. Модели защищены законодательством различных стран в качестве торговой марки, промышленного дизайна или на основании закона об авторских правах. Для получения более подробной информации, пожалуйста, свяжитесь с представительством MECCANO. Meccano не несет ответственности в случае: (I) несоблюдения инструкций, (II) использования деталей конструктора не по назначению, (III) любой деформации деталей конструктора. MECCANO заботится о детской безопасности: все модели тестируются детьми.

Warning! Attention! Achtung! Attenzione! ¡Atención! Aviso! Varning! Varoitus! Advarsel! Waarschuwing! Προειδοποίηση! Внимание! Varování! Tähelepanu! Įspėjimas! Figyelmeztetés! Twissija! Uwaga! Atenție! Pozor! Rabhadh! Uzmanibu! внимание!



- GB/USA** Warning! Choking Hazard. Contains small parts which could be swallowed. Not suitable for children under 3 years.
- FR** Attention ! Danger d'étouffement. Contient des petites pièces pouvant être absorbées. Ne convient pas aux enfants de moins de 3 ans.
- D** Achtung! Verschluckungsgefahr. Enthält verschluckbare Kleinteile. Nicht für Kinder unter 3 Jahren geeignet.
- I** Attenzione, pericolo di soffocamento! Contiene pezzi piccoli che potrebbero essere ingoiati. Non adatto ai bambini sotto i 3 anni.
- E** ¡Atención! Riesgo de asfixia. Contiene piezas pequeñas que un niño podría tragarse. No conviene a los niños menores de 3 años.
- P** Aviso! Perigo de se engasgar. Contém peças pequenas que podem ser engolidas. Não aconselhável a crianças com menos de 3 anos.
- S** Varning! Risk för kvävning. Innehåller små delar som kan sväljas. Ej lämplig för barn under 3 års ålder.
- FIN** Varoitus! Tukehtumisvaara. Sisältää pieniä osia, jotka voidaan niellä. Ei sovellu alle 3-vuotiaille lapsille.
- DK** Advarsel! Fare for slugning. Indeholder små dele, som kan sluges. Ikke velegnet for børn under 3 år.
- NL** Waarschuwing ! Verstikkingsgevaar. Bevat kleine onderdelen die kunnen worden ingeslikt. Niet geschikt voor kinderen onder 3 jaar.
- GR** Προειδοποίηση! Κίνδυνος πνιγμού. Περιέχει μικρά εξαρτήματα που θα μπορούσαν να καταποθούν. Ακατάλληλο για παιδιά κάτω από 3 ετών.
- BULGARIAN** Внимание! Опасност от задушаване. Съдържа малки части, които могат да бъдат погълнати. Не е подходящо за деца под 3 години.
- CZECH** Varování ! Nebezpečí udušení. Obsahuje malé díly, které by mohly být spolknuty. Nevhodné pro děti do 3 let.
- ESTONIAN** Tähelepanu ! Lämbumisoh. Sisaldab väikseid osi, mida saab alla neelata. Ei sobi alla 3. aasta vanustele lastele.
- LITHUANIAN** Įspėjimas! Uždusimo pavojus. Yra smulkių dalių, kurias galima nuryti. Netinka vaikams iki 3 metų.
- HUNGARIAN** Figyelmeztetés! Fulladásveszély. Ápró alkatrészeket tartalmaz, amelyeket a gyermek elnyelhetnek. 3 évesnél fiatalabb gyermekek számára nem alkalmas.
- MALTESE** Twissija! Periklu li wiehed jifga. Fih partijiet iżghar li jistgħu jinbelgħu. Mhuwiex adattat għal tfal iżgħar minn 3 snin.
- POLISH** Uwaga! Ryzyko uduszenia. Zawiera małe części, które mogą zostać połknięte. Produkt nieodpowiedni dla dzieci poniżej 3 lat.
- ROMANIAN** Atenție! Pericol de sufocare. Conține piese mici care pot fi înghițite. Interzis copiilor sub 3 ani.
- SLOVAK** Pozor! Nebezpečnostvo udusenja. Obsahuje malé diely, ktoré je možné prehltnúť. Nie je vhodné pre deti mladšie ako 3 roky.
- SLOVENIAN** Pozor! Nevarnost zadušitve. Vsebuje majhne dele, ki jih je možno zaužiti. Ni primerno za otroke, mlajše od 3 let.
- IRISH** Rabhadh! Guais Tachta. Píosaí beaga ann a fhéadhadh a bheith insúite. Níl an bréagán seo oiriúnach do pháistí atá níos óige ná trí bhliain d'aois.
- LATVIAN** Uzmanību! Nosmakšanas draudi. Satur sīkas detaļas, kuras var tikt norītas. Nav piemērots bērniem, kas jaunāki par 3 gadiem.
- RUSSIA** Внимание! Возможен риск удушья. В наборе имеются мелкие детали, которые легко проглотить. Противопоказан детям младше 3 лет.



UBISOFT
© 2013 Ubisoft Entertainment.



363, avenue de Saint Exupéry
62100 Calais - France
<http://www.meccano.com>
<http://www.erektor.us>
© 07/2013 MECCANO

®MECCANO and EREKTOR are exclusive trademarks of MECCANO
All rights reserved

