

Instructions
Notice de montage
Bauanleitung
Istruzioni di montaggio
Instrucciones de montaje
Instruções de montagem
Monteringsanvisning
Kokoamisohje
Monterings instruktioner
Montagehandleiding
Οδηγίες συναρμολόγησης.
組立説明書

MULTIMODELS



- FR) Merci d'imprimer échelle 1 sans les marges de l'imprimante.
- GB) Please print scale 1 without the printer margins.
- D) Den Maßstab 1 bitte randlos drucken.
- IT) Stampare la scala 1 senza i margini della stampante.
- E) Imprimir a escala 1 sin los márgenes de la impresora.
- P) É favor imprimir escala 1 sem as margens da impressora.
- S) Skriv ut i skala 1 utan skrivarens marginaler.
- FIN) Portaiden painatuksen jälkeen reunat eivät saa näkyä.
- DK) Udskriv venligst i målestoksforhold 1 uden printermargener.
- NL) É favor imprimir escala 1 sem as margens da impressora.
- GR) Σας παρακαλώ τυπώστε την κλίμακα 1 μέσα στα περιθώρια του εκτυπωτή.

7550

8-88



25 MODELS



36

6

32

16

24

11

28

20

44

40

48

52

55

58

62

65

68

72

75

79

82

86

89

92

96



C369 x2



A951 (0051G) x1



A173 (0073A) x2



B484 x1



C371 x2



A202 (0002) x4



A415 (0235D) x2



A203 (0003) x1



A414 (0235B) x1



A105 (0005) x2



A187 (0187C) x4



A045 (J0045) x4



A177 (0177A) x1



A248 (0048) x3



A126 (0126) x2



A252 (0051A) x2



A713 (0012B) x3



A506 (0006A) x2



A712 (0012C) x8



A012 (0012) x10



A212 (0212) x2

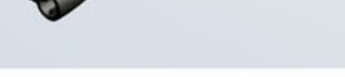

B953 x2



1,5m
59" | **A898 (0040B)** x1



50mm
2" | **A696 (0186H)** x2



25mm
1" | **A695 (0186G)**



C375 x2



130mm
5 1/16" | **A315 (0315)** x1



100mm
3 15/16" | **A428 (0315B)** x2



A334 (0110C) x1



C372 x2



A128 (0028P3P) x1



A627 (0022BP3P) x1



A423 (0260F) x2



A313 (0213B3P) x1



A025 (0025B3P) x2



B4 | 38,1mm
1 1/2" | **B696** x1

S5 | 25,4mm
1" | **A912 (0111E)** x1

B2 | 19mm
3/4" | **A447 (0147F)** x2

B1 | 14,7mm
5/8" | **A247 (0147D)** x8

S3 | 12mm
1/2" | **A411 (0111A)** x5

S2 | 9,5mm
3/8" | **A511 (0111C)** x1

S1 | 5,8mm
15/64" | **A637 (0037B)** x55



A623 (0023C3P) x2

A444 (0144C) x2

A239 (0038A) x9

A338 (0038B) x4

A259 (0059C) x7

A337 (0037A) x71

A737 (0037H) x4

A138 (0038) x4



A651 x1

A136 (0036C) x1

C088 x1

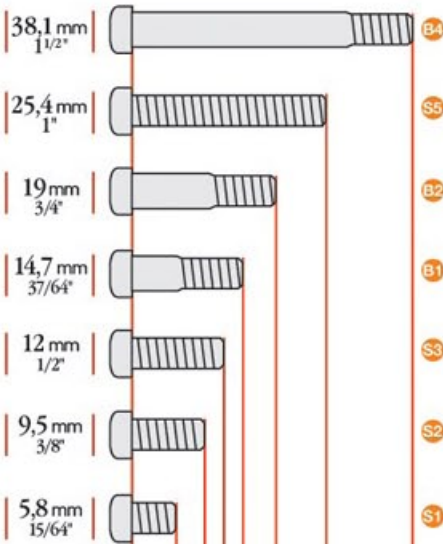
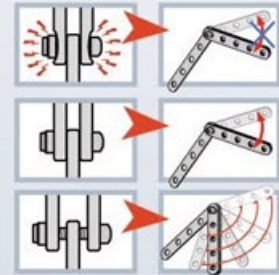
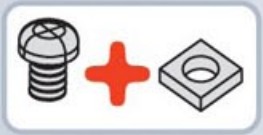
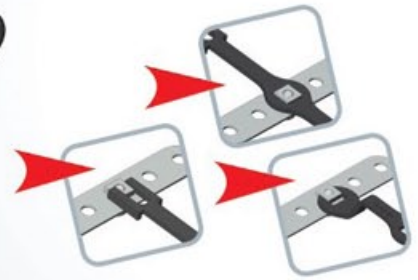
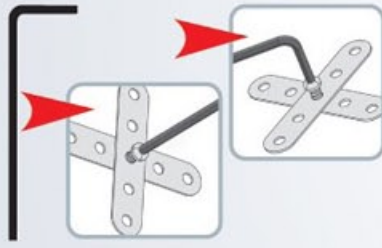

Scale
Echelle
Maßstab
Scala

Escala
Schaal
Escala
Skala

Mittakaava
Målestok
Κλίμακα
スケール

1:1

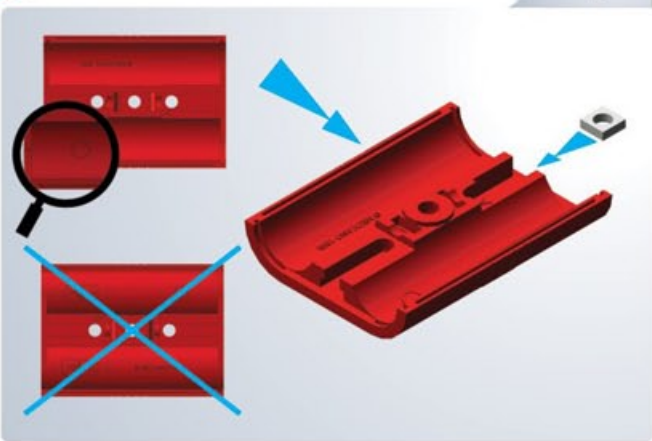
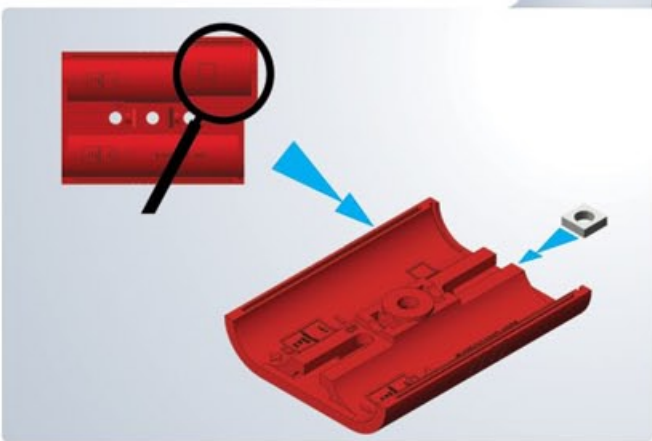
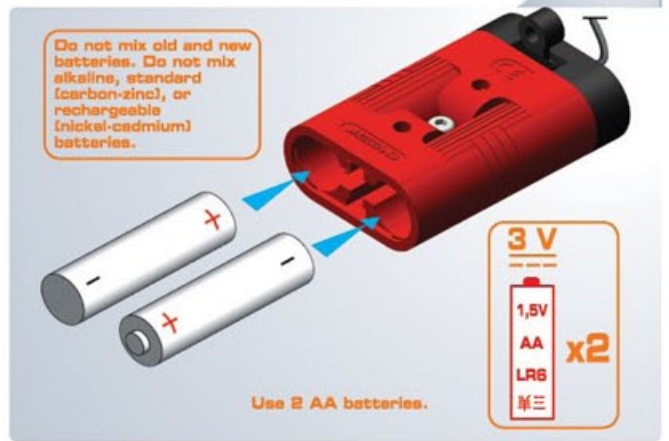
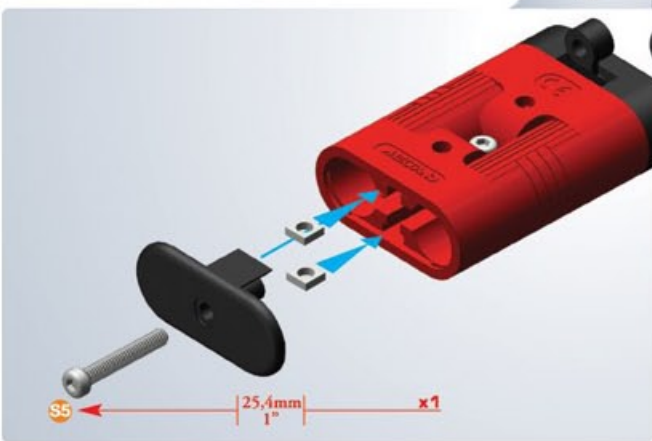

1**2****3****4****5****6****7**





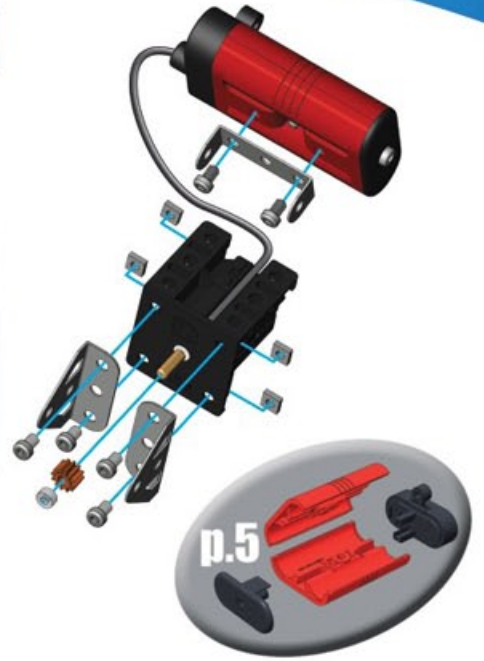

1

-  x1
-  x1
-  x2
-  x1
-  x1
-  5,8mm | 15/64" x6
-  x4



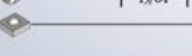



2

-  x1
-  x1
-  5,8mm | 15/64" x3
-  x3







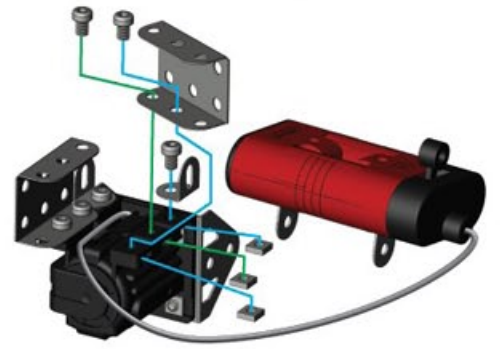

3

-  x1
-  x1
-  5,8mm | 15/64" x3
-  x3



4

-  x2
-  x1
-  x1
-  x2
-  x1
-  5,8mm | 15/64" x5
-  x5

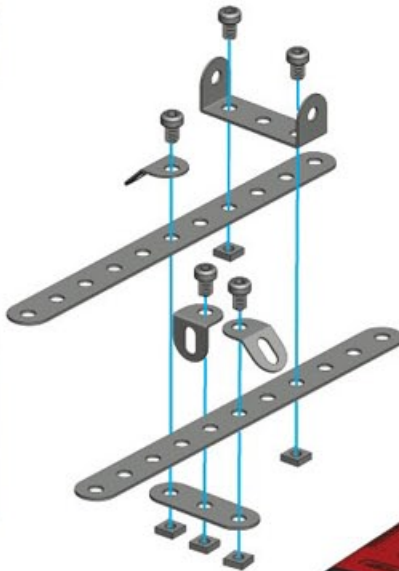

5



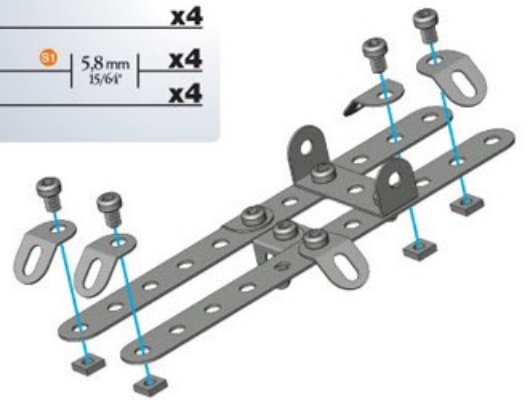

-  x4
-  5,8mm | 15/64" x4
-  x4



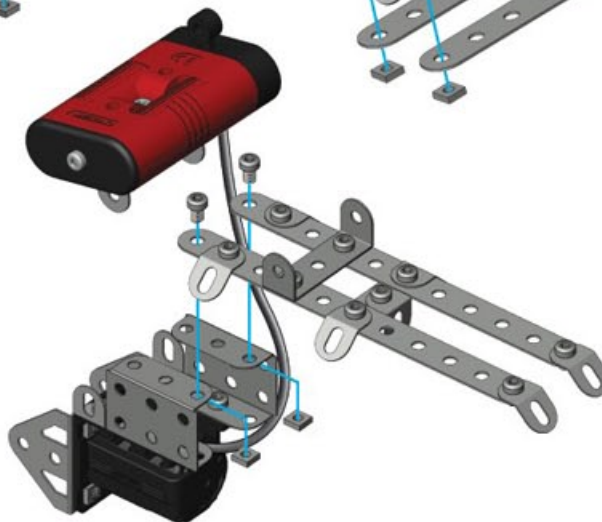



6

- $(3) + (5) +$
-  5,8mm | 15/64" x2
-  x2

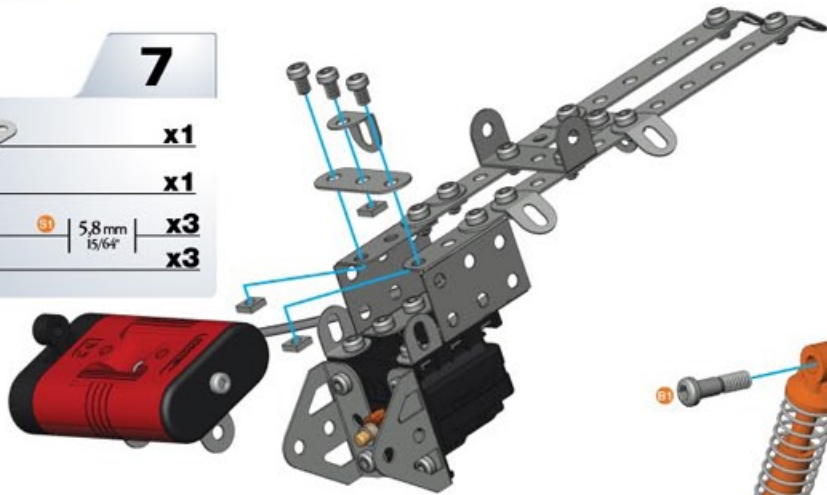

- 7**
-  **x1**
 -  **x1**
 -  **x3**
 -  **x3**





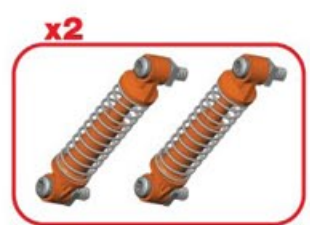

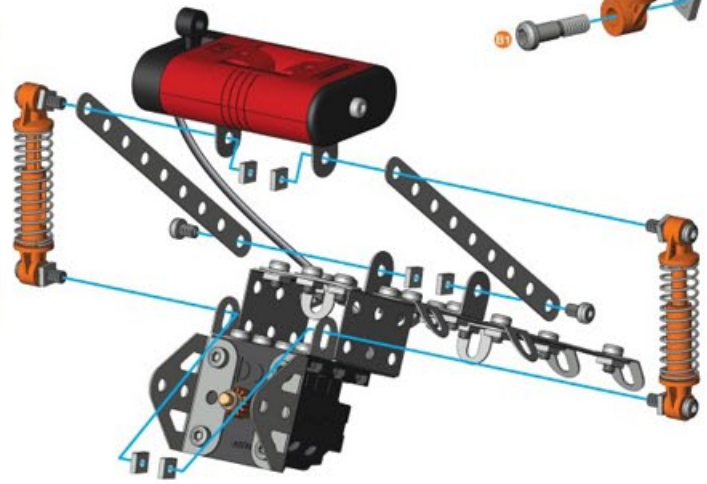

- 8**
-  **x2**
 -  **x4**
 -  **x4**







- 7 + 8 + 9**
-  **x2**
 -  **x2**
 -  **x6**

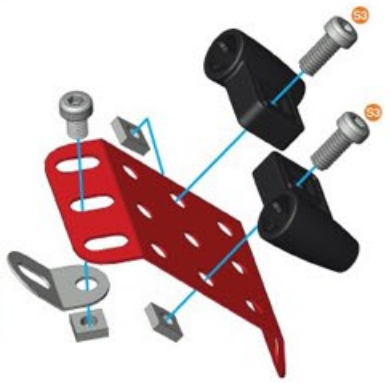



- 10**
-  **x1**
 -  **x2**
 -  **x1**
 -  **x2**
 -  **x1**
 -  **x3**



- 11**
-  **x1**
 -  **x1**
 -  **x1**
 -  **x1**



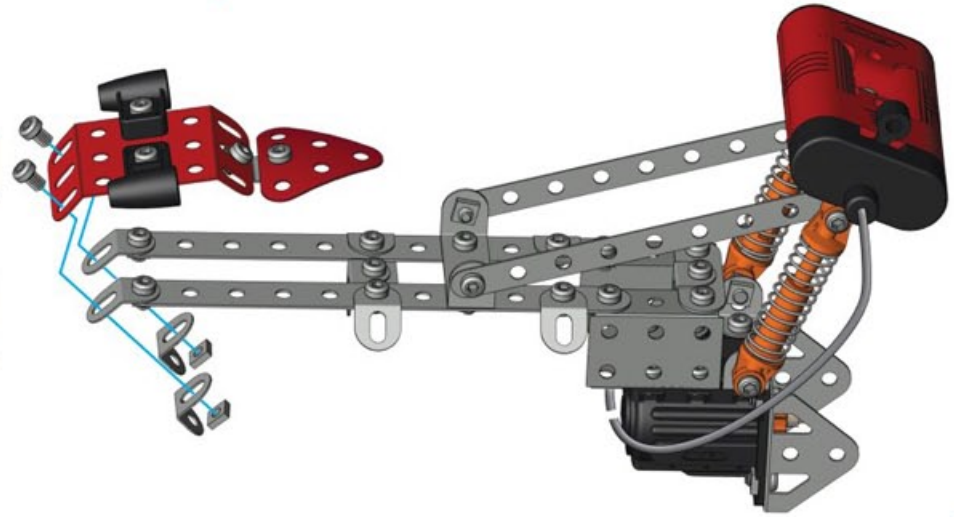

- 9 + 11 + 12**
-  **x2**
 -  **x2**
 -  **x2**

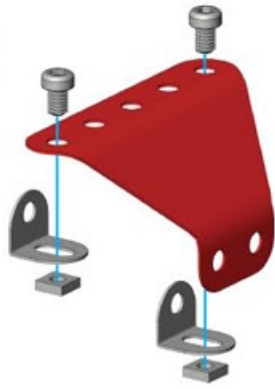
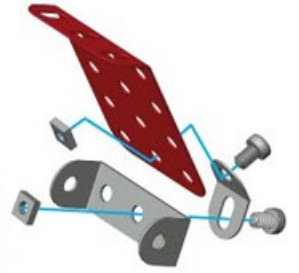
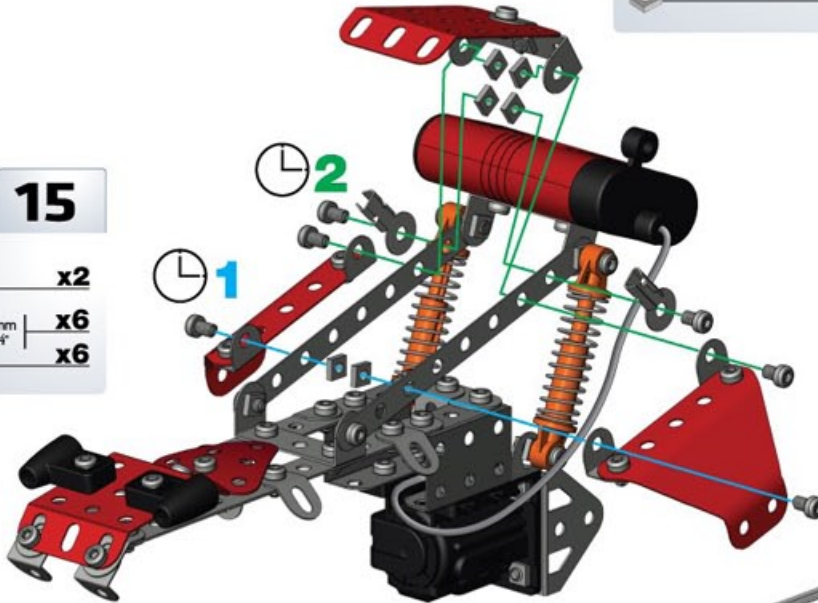
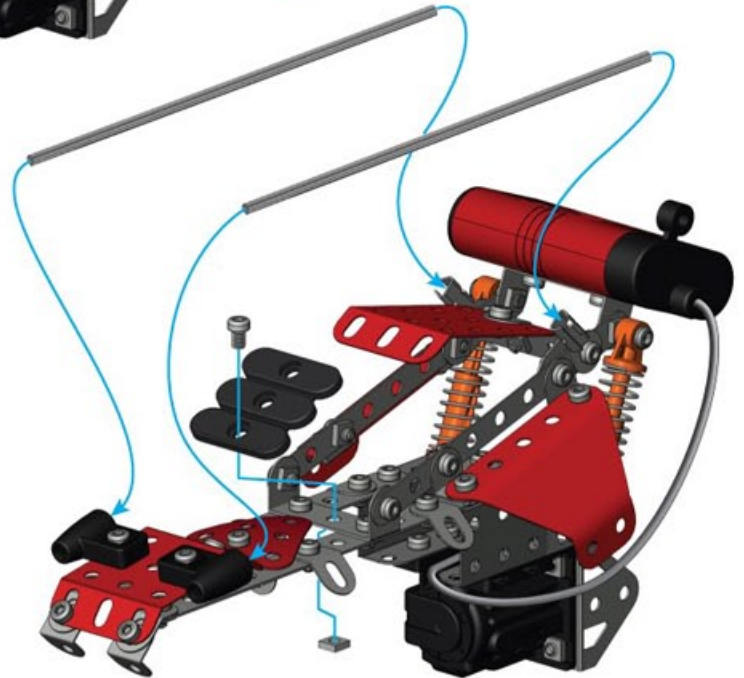

13**x2****x4**5.8mm
15/64"**x4****x4****x2****14****x1****x1****x1**5.8mm
15/64"**x2****x2****12+13+14+****15****x2**5.8mm
15/64"**x6****x6****16****x2****x1****x1****x1****17****x1****x1****x2****18****x1****x1****x2**



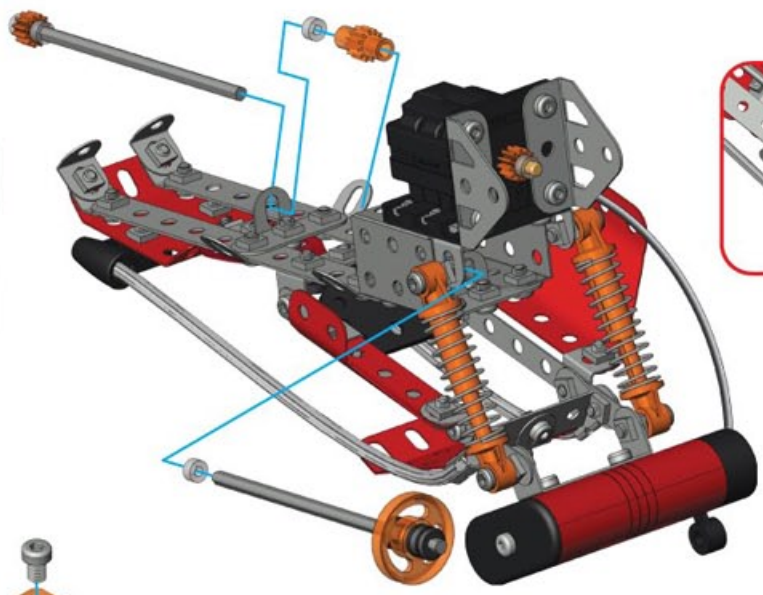

19

16 + 17 + 18 +

-  x1
-  x2





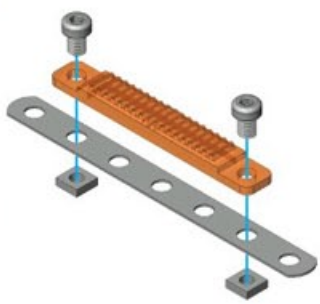

20

-  x1
-  x1
-  (S1) 5,8mm 15/64" x2
-  (S2) x2







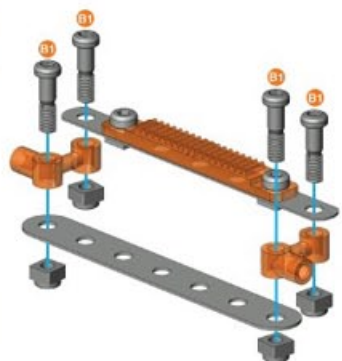

21

-  x1
-  x2
-  (S1) 14,7mm 37/64" x4
-  (S2) x4





22

19 + 22 +

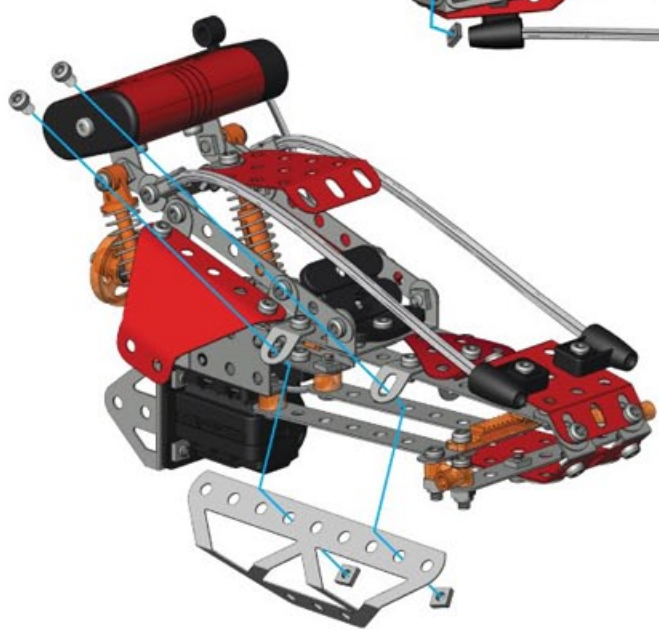
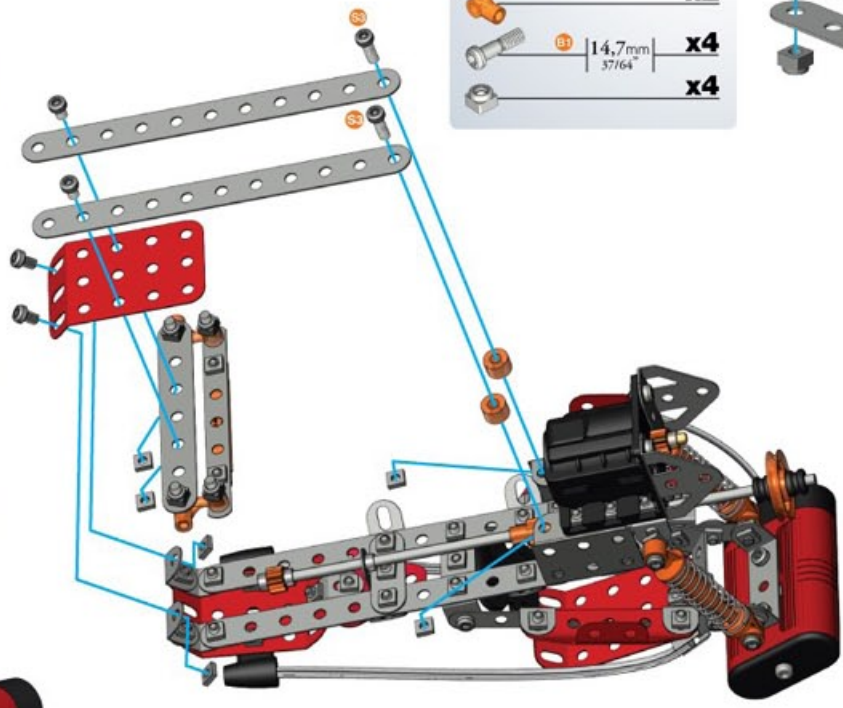
-  x2
-  x1
-  x2
-  (S1) 12mm 1/2" x2
-  (S2) 5,8mm 15/64" x4
-  (S3) x6



23

-  x1
-  (S1) 5,8mm 15/64" x2
-  (S2) x2

24

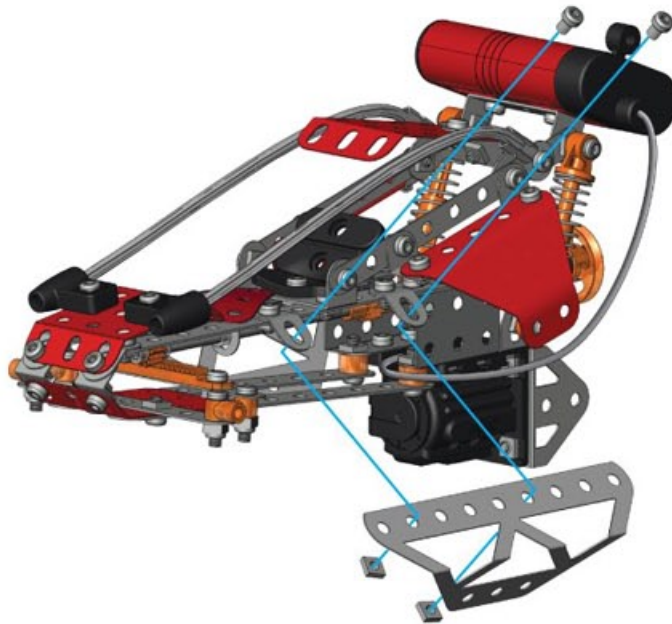
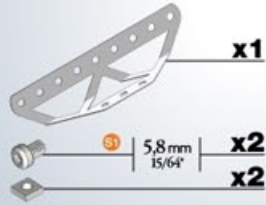

25

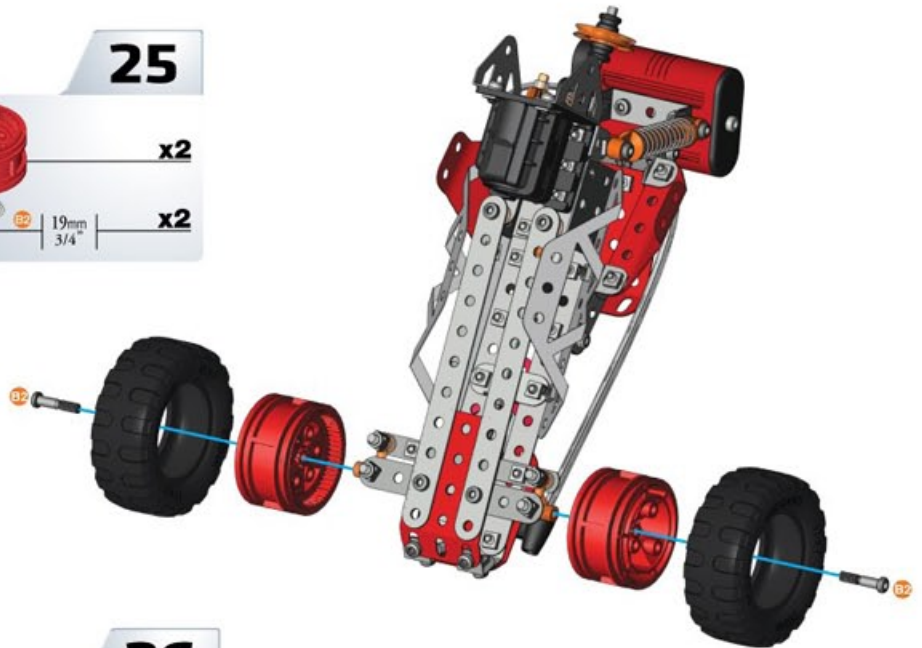

26

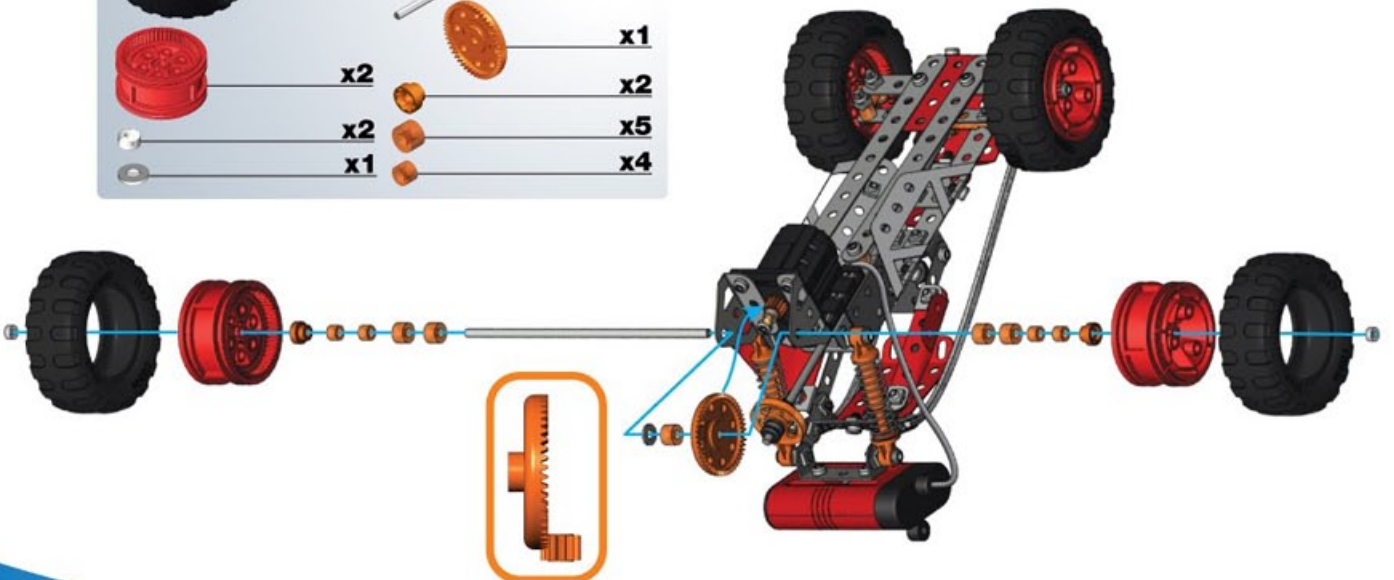
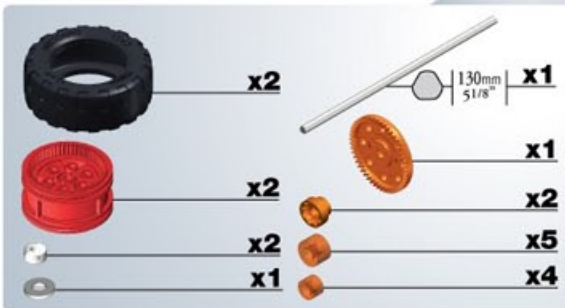







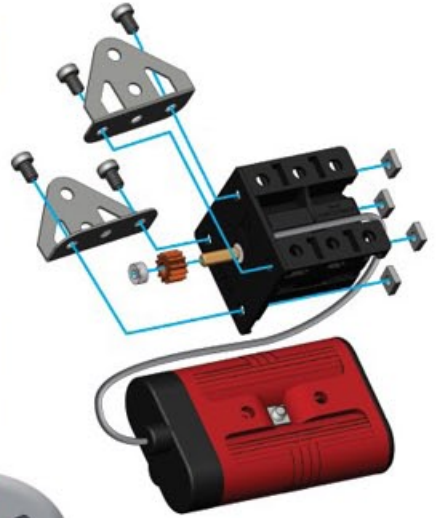

1

-  x1
-  x2
-  x1
-  x1
-   x4
-   x4







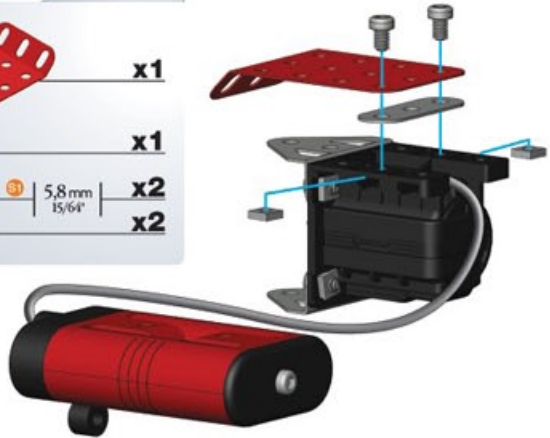







2

-  x1
-  x1
-   x2
-   x2







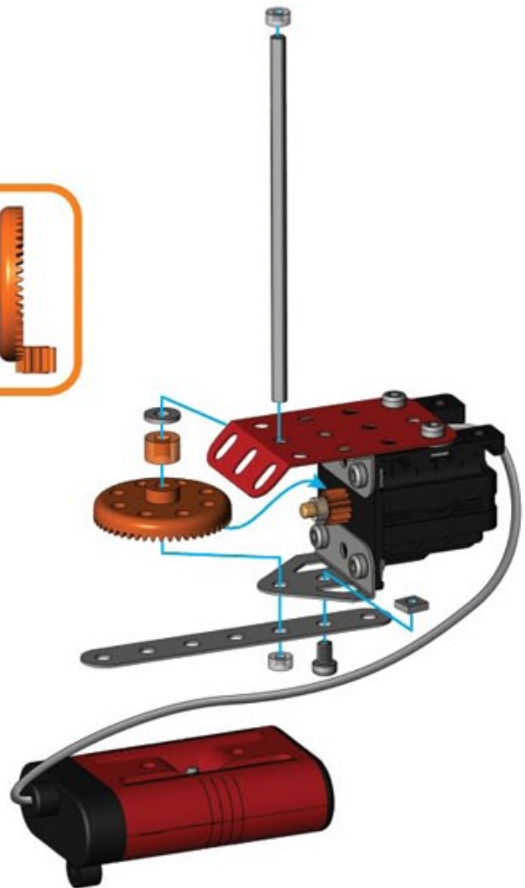

3

-   x1
-  x1
-  x2
-  x1
-  x1
-   x1
-   x1
-   x1



4

-  x2
-  x2
-   x2
-   x2

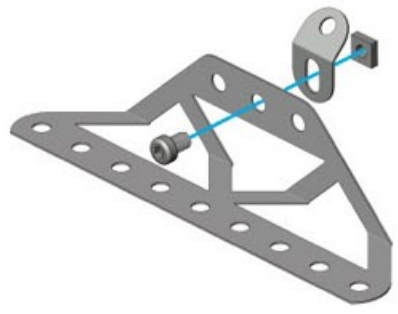

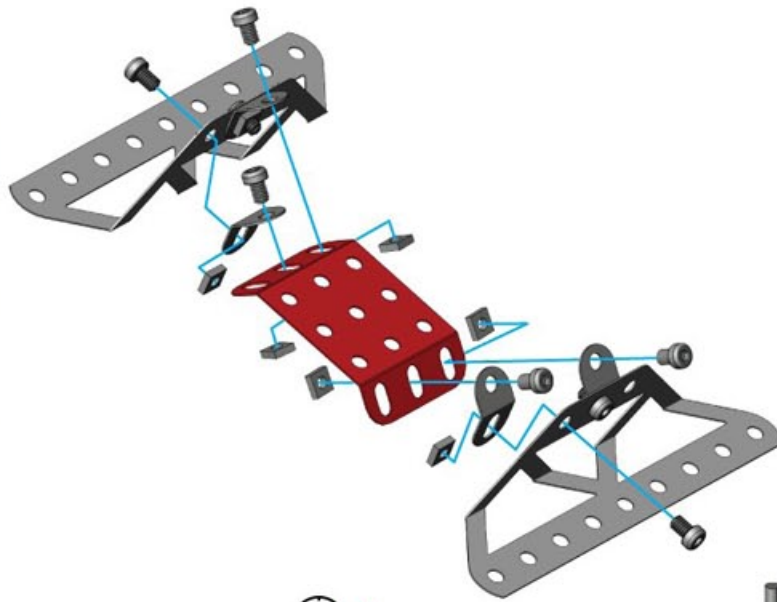
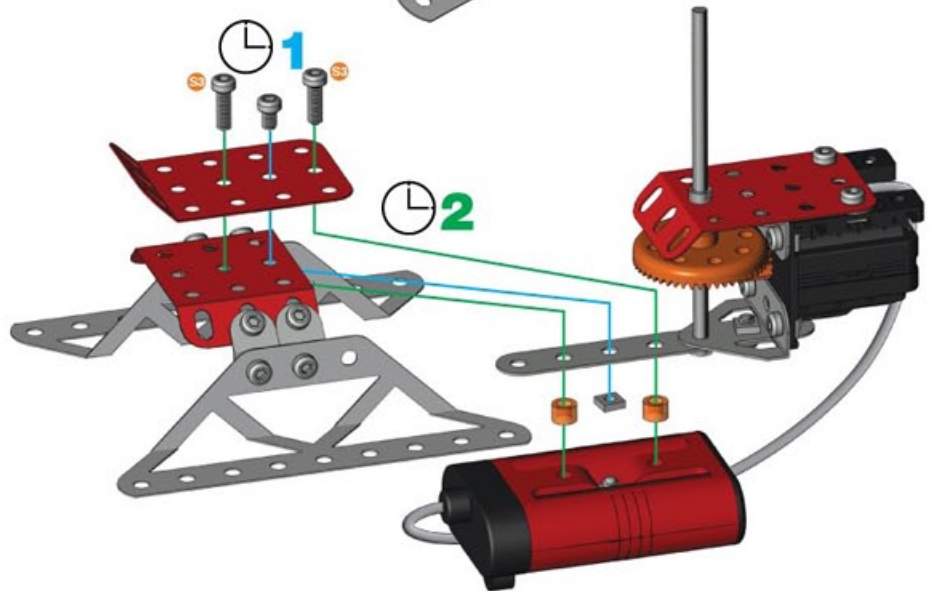
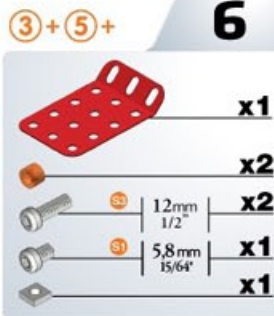
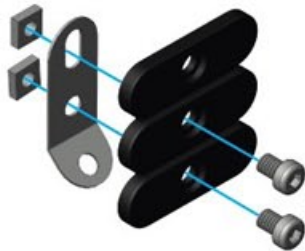
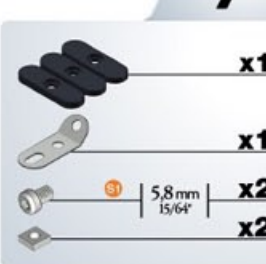
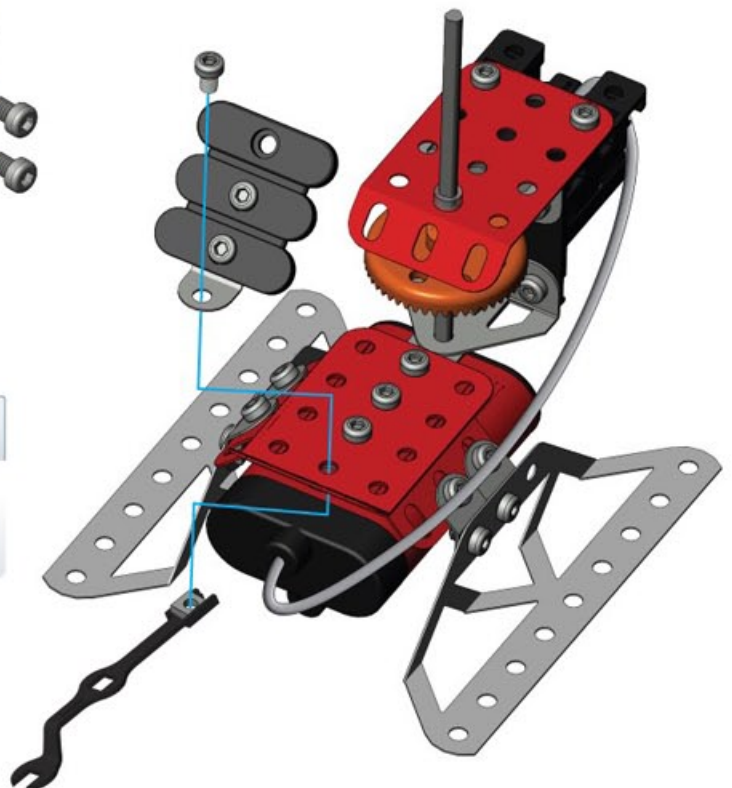



5**6****7****8**

9

-  x2
-  x2
-  x2
-  x2
-  x2





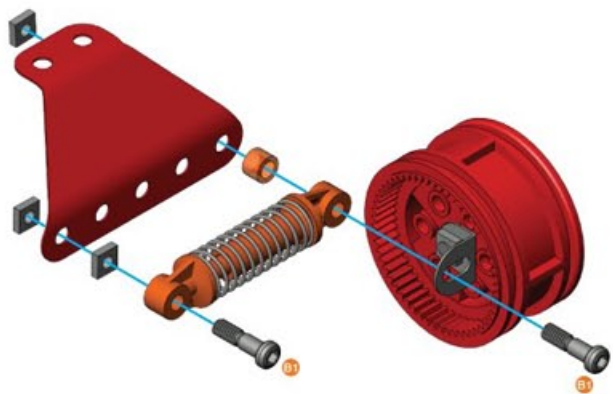

10

-  x1
-  x1
-  x2
-  x1
-  x3





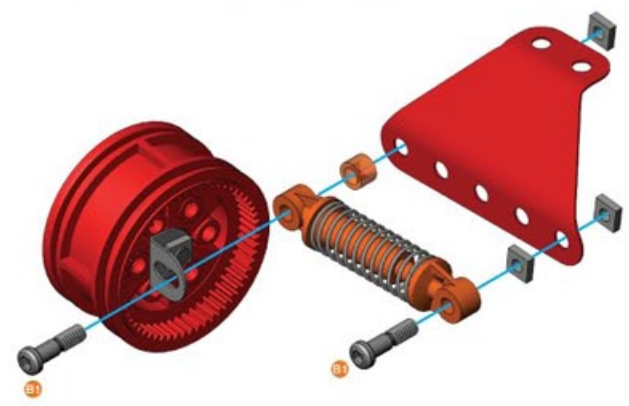

11

-  x1
-  x1
-  x2
-  x1
-  x3





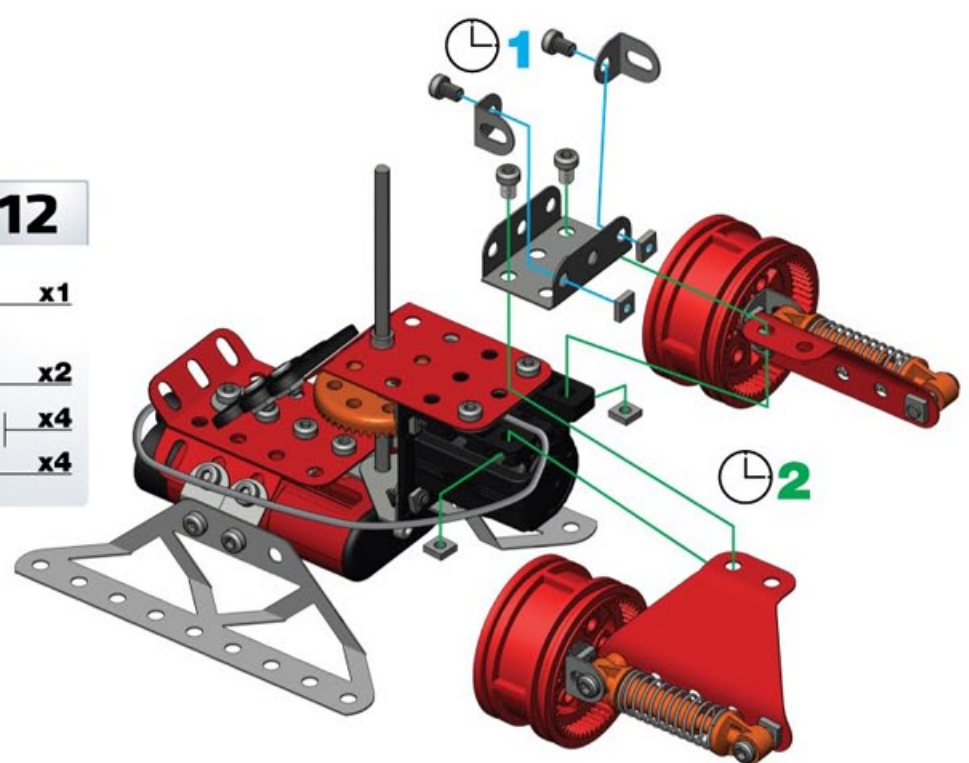

8 + 10 + 11 + 12

-  x1
-  x2
-  x4
-  x4



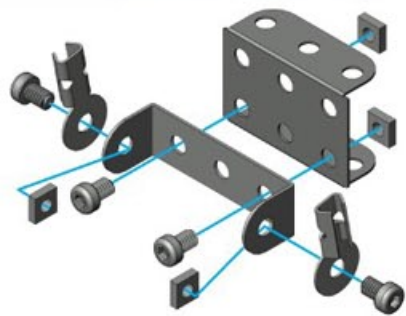

13

-  **x1**
-  **x1**
-  **x2**
-  **x4**
-  **x4**





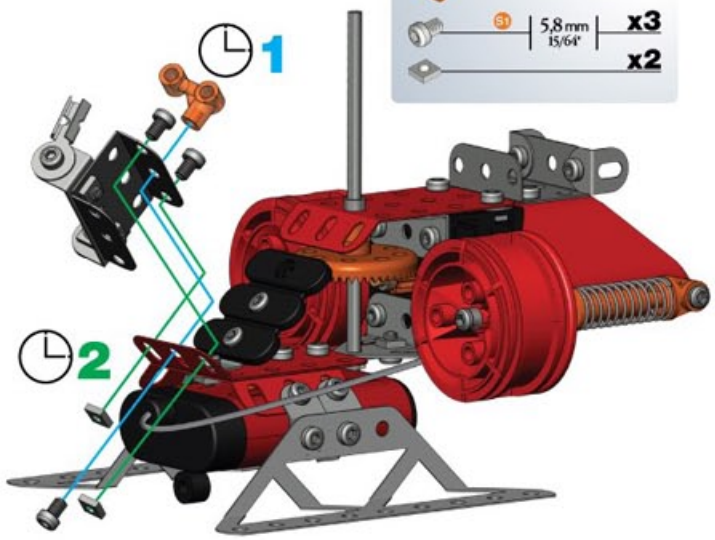

14

- 12 + 13 +**
-  **x1**
-  **x3**
-  **x2**



15

-  **x1**
-  **x2**
-  **x2**
-  **x2**
-  **x4**

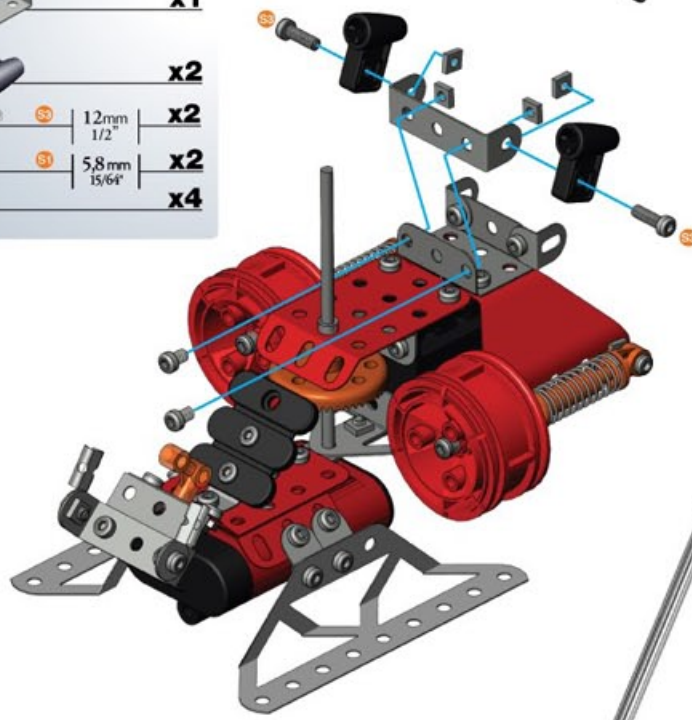



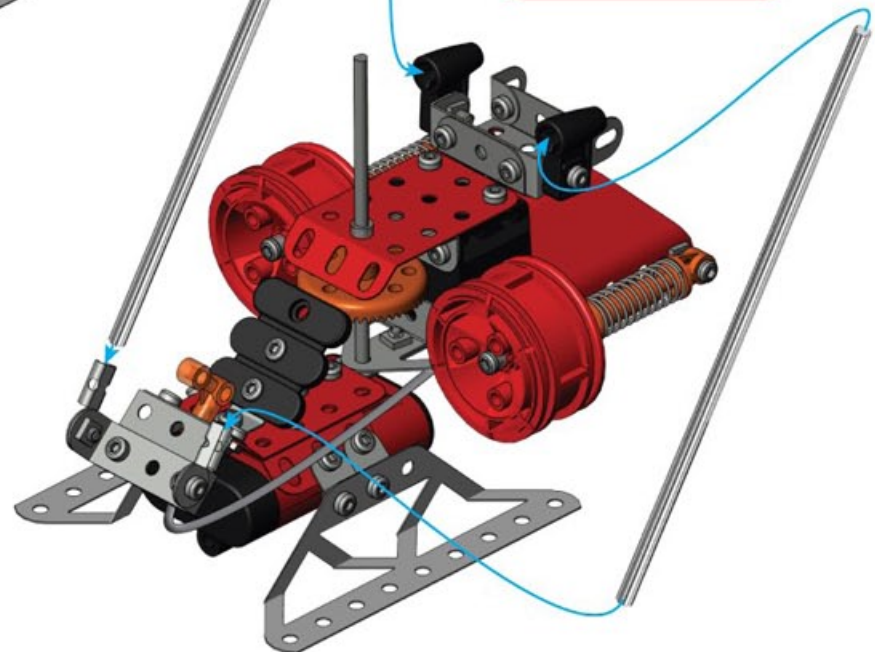

16

-  **x2**

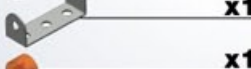
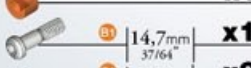

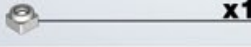

17

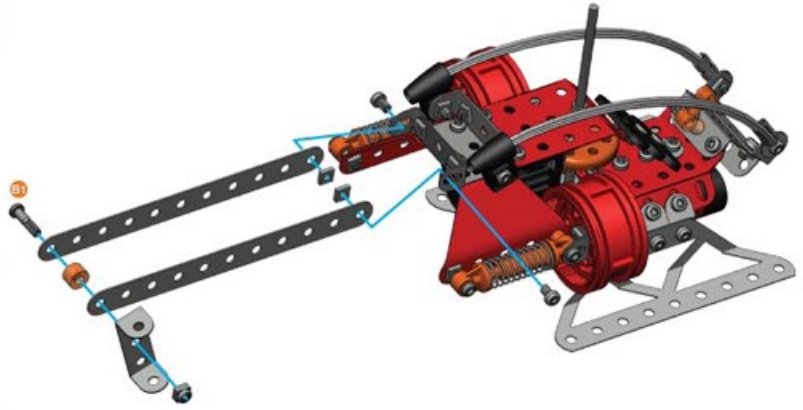
-  x2
-  x1
-  x1
-  ³¹ 14,7mm | 37/64" x1
-  ³¹ 5,8mm | 15/64" x2
-  x2
-  x1

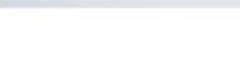

18

-  x2
-  x2
-  ³¹ 5,8mm | 15/64" x2
-  x2

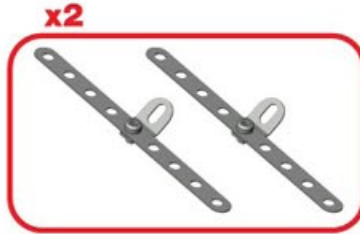
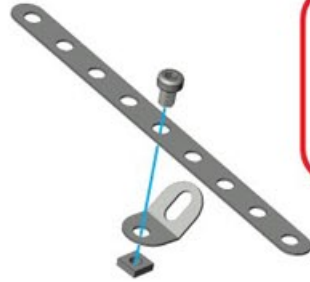

x2



17 + 18 +

19

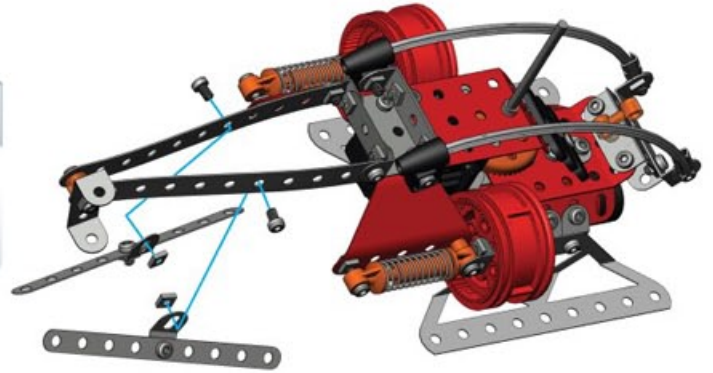
-  ³¹ 5,8mm | 15/64" x2
-  x2



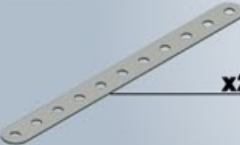



20

-  x2
-  ³¹ 5,8mm | 15/64" x2
-  x2

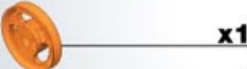

19 + 20 +

21

-  x1
-  x1
-  x1
-  x3
-  x1









1

-  x1
-  x1
-  x4
-  ^{S1} 5,8 mm | 15/64" x5
-  x4
-  x1







2

-  x1
-  x1
-  ^{S2} 12mm | 1/2" x1
-  ^{S1} 5,8 mm | 15/64" x1
-  x1





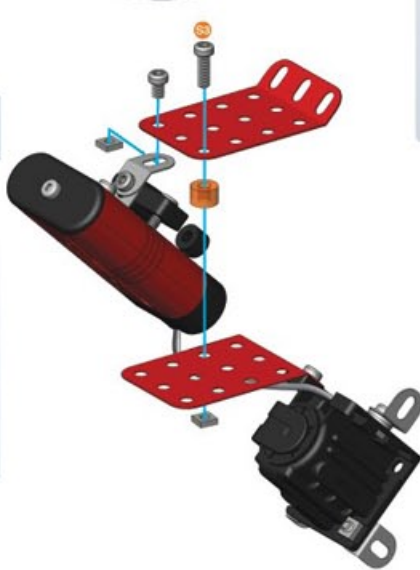

3

-  x1
-  x1
-  ^{S2} 12mm | 1/2" x1
-  ^{S1} 5,8 mm | 15/64" x1
-  x2



4

-  x1
-  x2
-  ^{S1} 5,8 mm | 15/64" x3
-  x3

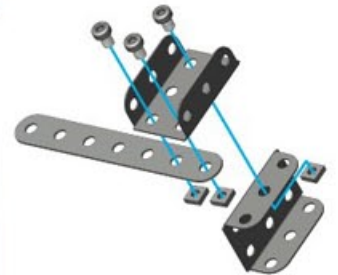



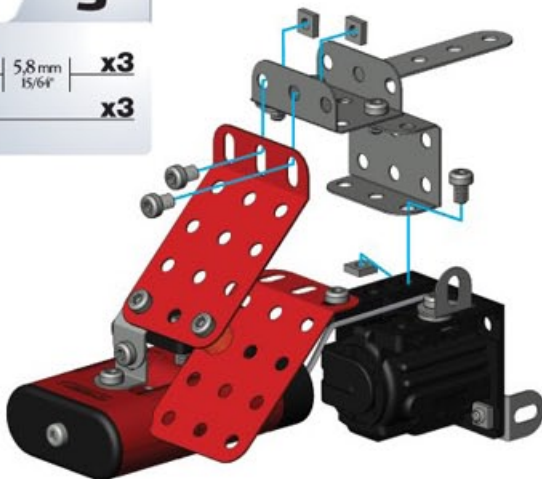

5

- 3 + 4 +**
-  ^{S1} 5,8 mm | 15/64" x3
 -  x3







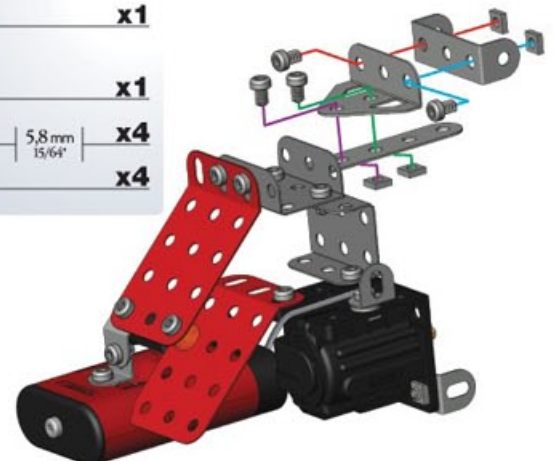

6

-  x1
-  x1
-  5,8 mm | 15/64" x4
-  x4



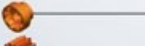

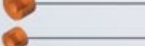
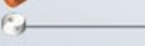
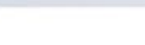
7

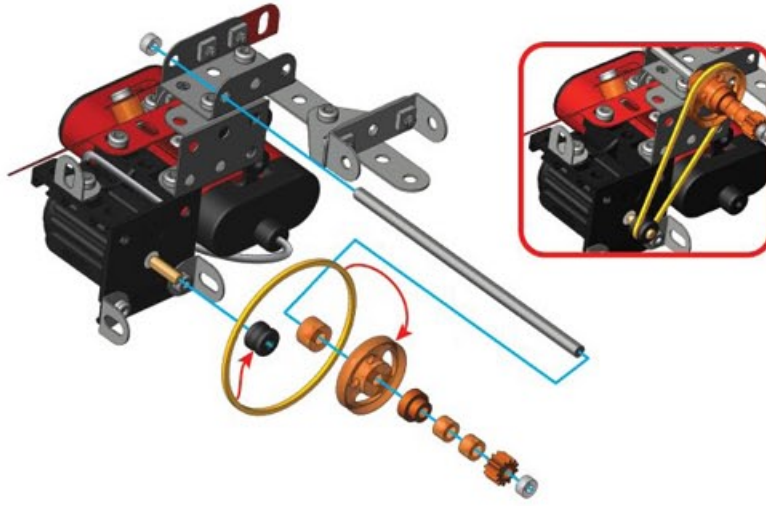
-  100mm $\frac{1}{4}$ " x1
-  x1
-  x1
-  x1
-  x1
-  x1
-  x1
-  x2
-  x2

**8**

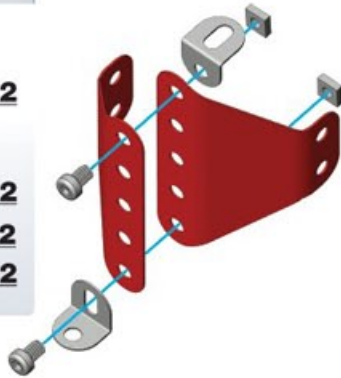
-  x2
-  x2
-  5,8mm $\frac{15}{64}$ " x2
-  x2



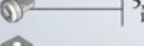
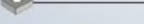

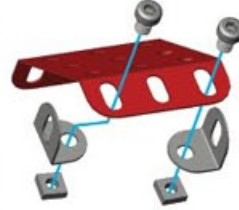
**9**

-  x1
-  x2
-  5,8mm $\frac{15}{64}$ " x2
-  x2

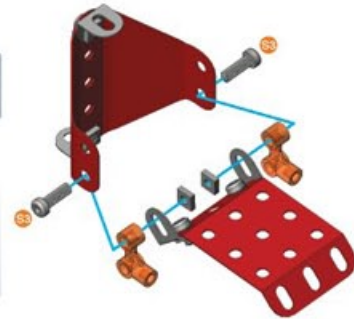
**10**

- $(8) + (9) +$
-  x2
-  12mm $\frac{1}{2}$ " x2
-  x2



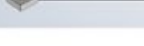

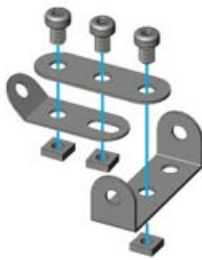
**11**

-  x1
-  x1
-  x1
-  5,8mm $\frac{15}{64}$ " x3
-  x3

**12**

-  x2
-  14,7mm $\frac{37}{64}$ " x4
-  x4

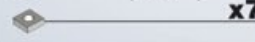



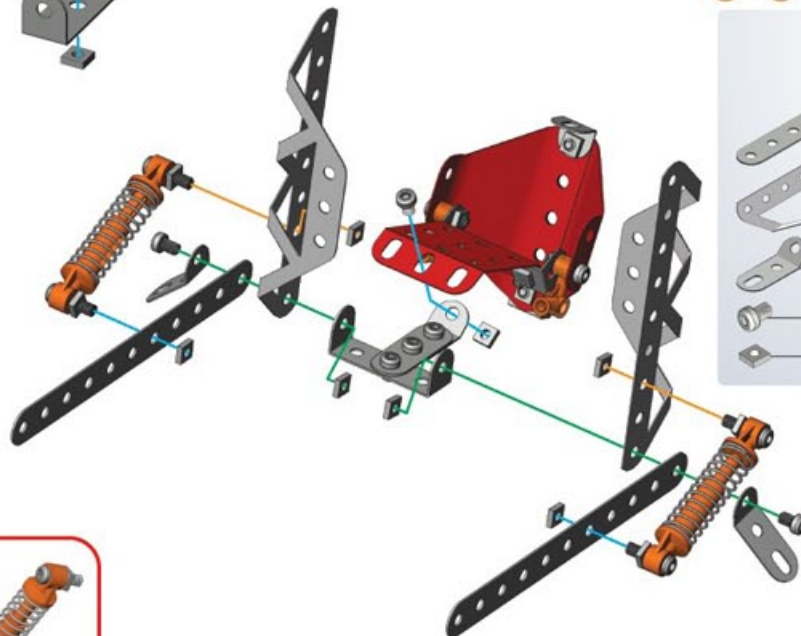

**x2****13**

- $(10) + (11) + (12) +$
-  x2
-  x2
-  x2
-  5,8mm $\frac{15}{64}$ " x3
-  x7



7+13+

14

-  x1
-  x1
-  x1
-  12mm 1/2" x1
-  5,8mm 15/64" x4
-  x5

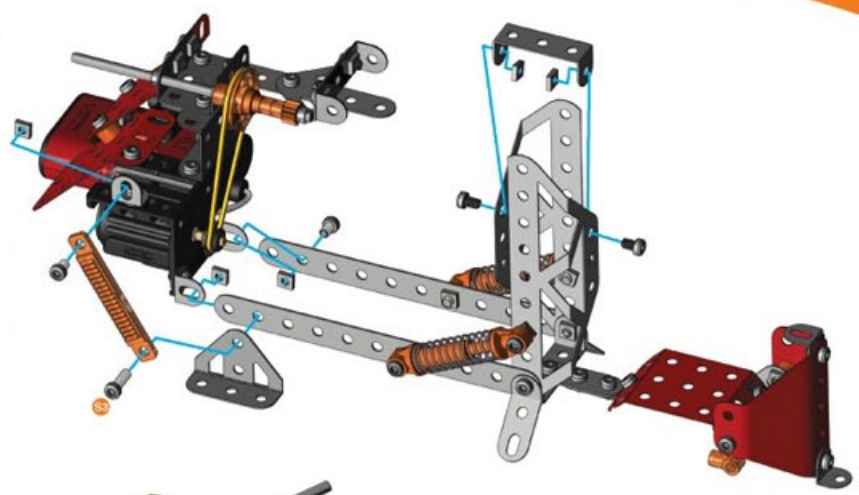

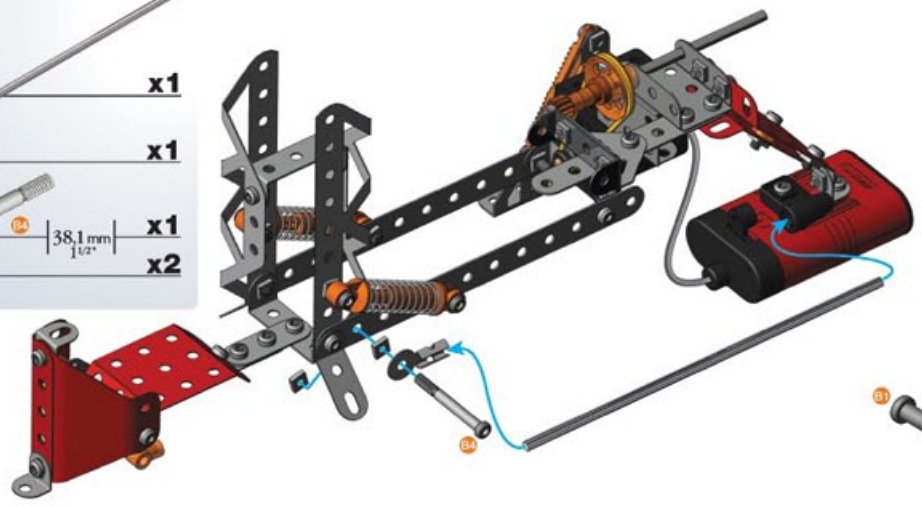

15

-  x1
-  x1
-  38,1mm 1 1/2" x1
-  x2



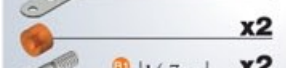
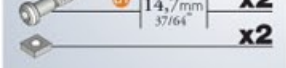

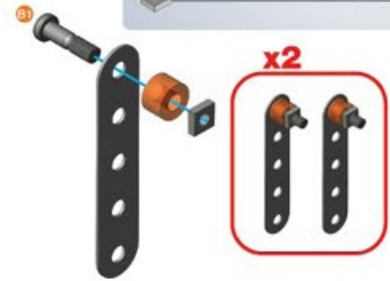

16

-  x2
-  x2
-  14,7mm 37/64" x2
-  x2



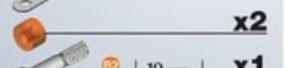

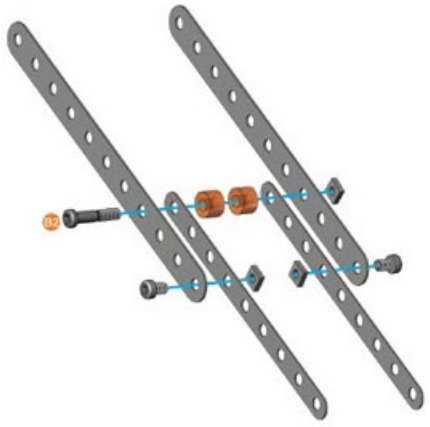

17

-  x2
-  x2
-  x2
-  19mm 3/4" x1
-  5,8mm 15/64" x2
-  x3

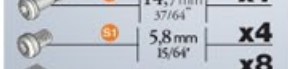

15+16+17+

18

-  130mm 5 1/8" x1
-  x1
-  14,7mm 37/64" x1
-  5,8mm 15/64" x4
-  x8

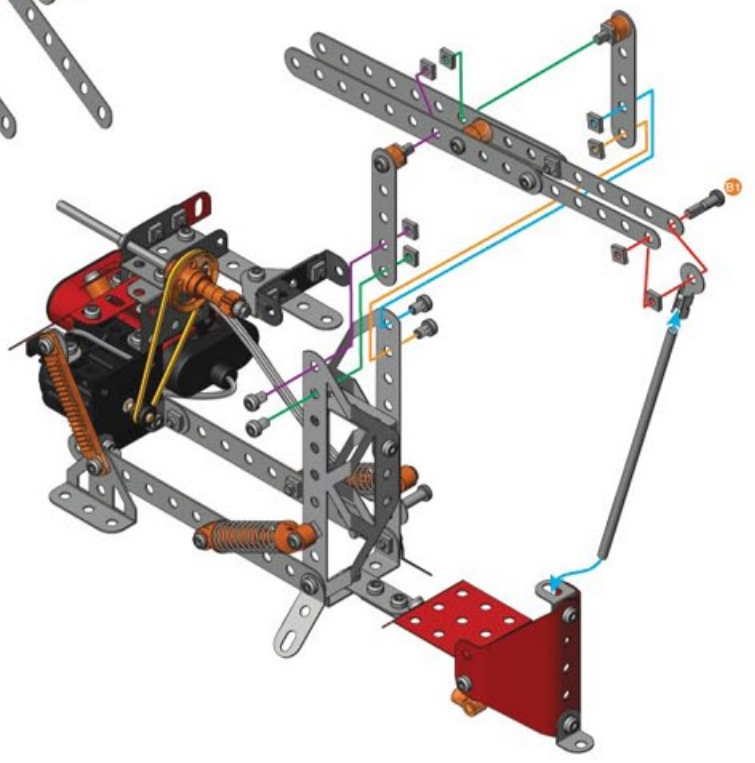

19

	x1
	x1
	x1
	x2
	x2
	x1



18 + 19 +

20

	5,8 mm	x1
	15/64"	x1

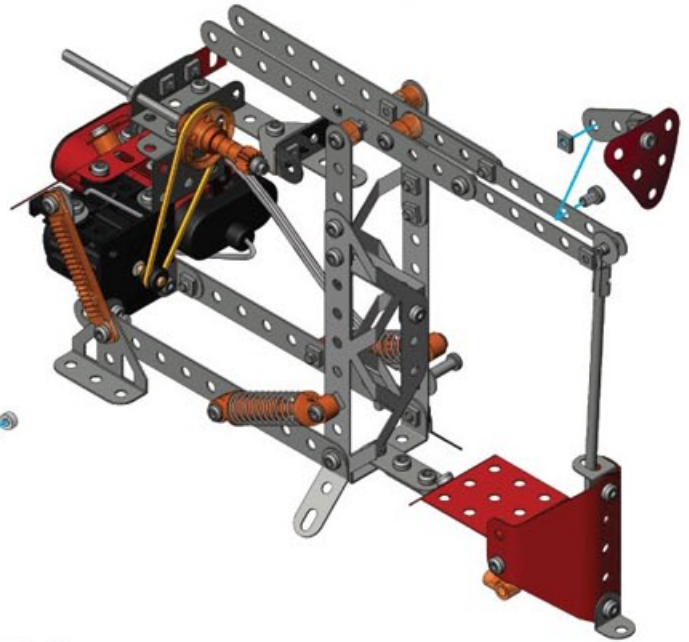

21

	100 mm	x1
		x1
		x1
		x1
		x2

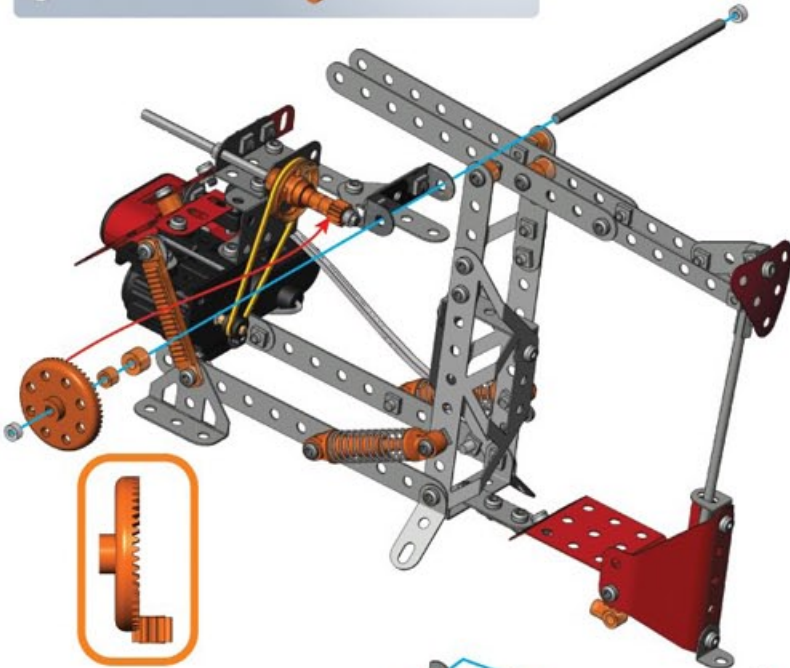

22

	x1	
	x1	
	14,7 mm	x1
	37/64"	x1

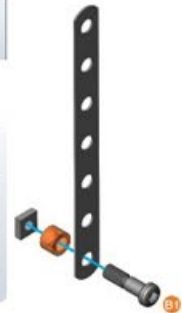

21 + 22 +

23

	x2	
	19 mm	x1
	3/4"	x1
		x1

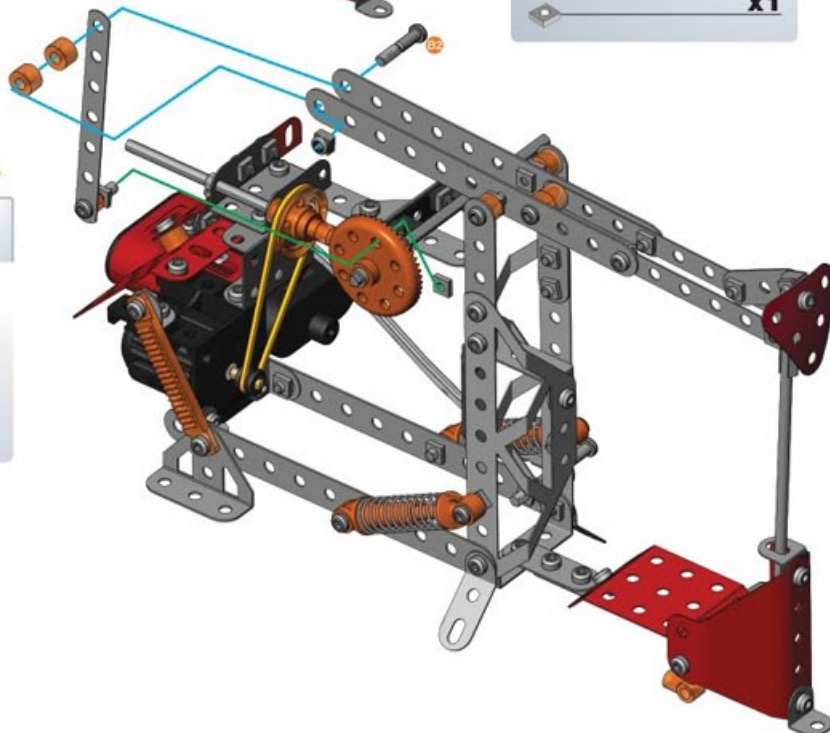







1

-  x1
-  x2
-  x1
-  x1
-  5,8mm | 15/64" x4
-  x4







3

-  x1
-  x1
-  x2
-  5,8mm | 15/64" x3
-  x3



2

-  130mm | 5 1/8" x1
-  x1
-  x1
-  x2
-  x1

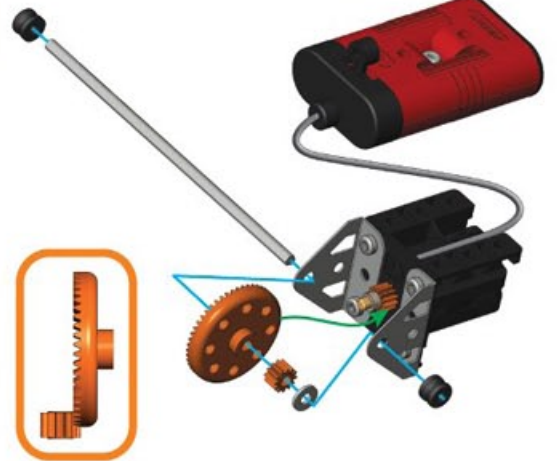



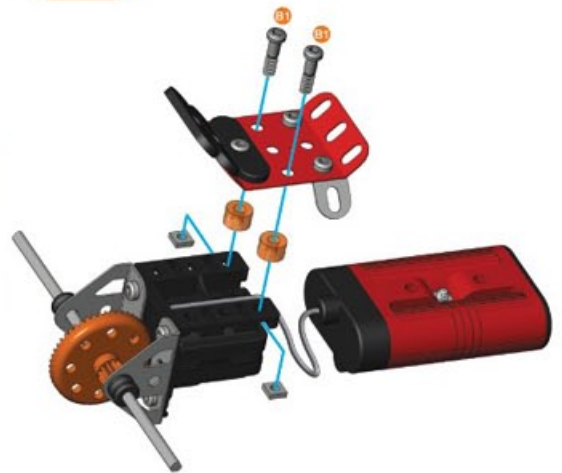

4

- ② + ③ +  x2
-  14,7mm | 37/64" x2
-  x2





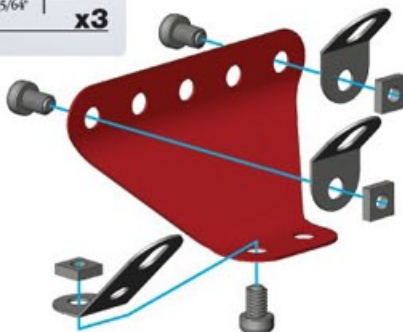

5







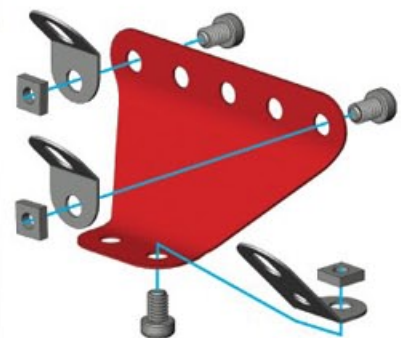

-  x1
-  x1
-  x2
-  5,8mm | 15/64" x3
-  x3







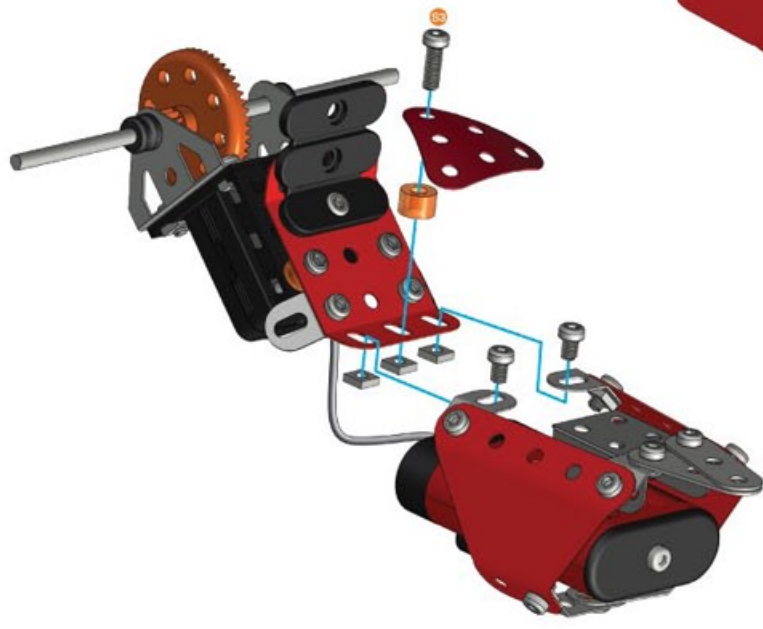
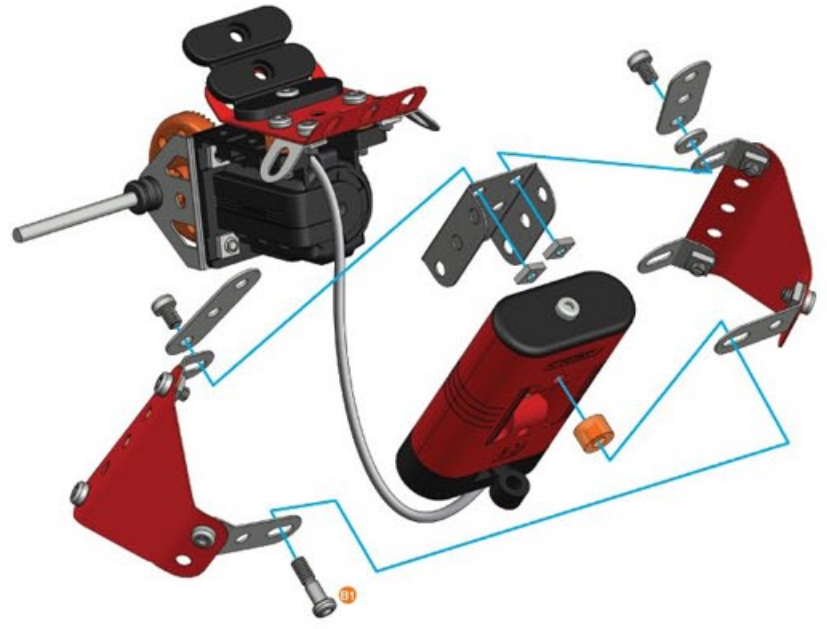

6

-  x1
-  x1
-  x2
-  5,8mm | 15/64" x3
-  x3









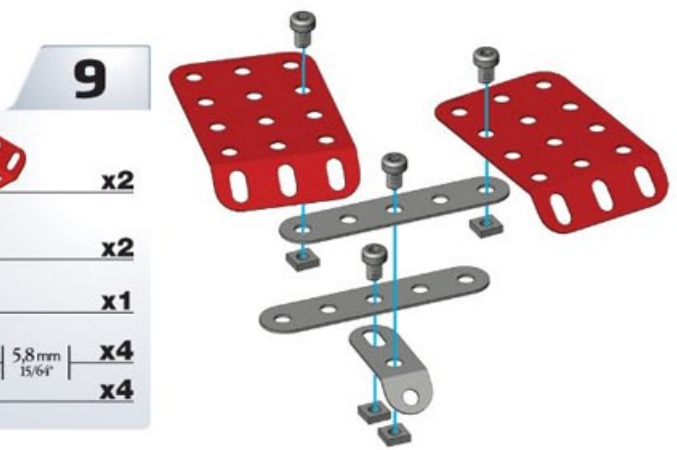

- 5+6+** **7**
-  **x1**
 -  **x2**
 -  **x1**
 -  **x1**
 -  **x1** | 14,7mm | 37/64" **x1**
 -  **x2** | 5,8mm | 15/64" **x2**
 -  **x3**
 -  **x1**







- 6+7+** **8**
-  **x1**
 -  **x1**
 -  **x1** | 12mm | 1/2" **x1**
 -  **x2** | 5,8mm | 15/64" **x2**
 -  **x3**

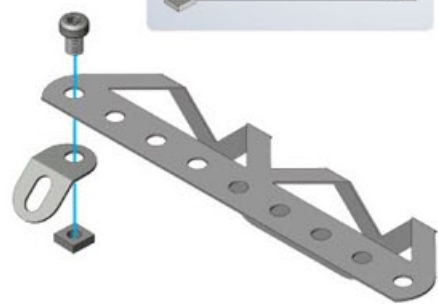

- 9**
-  **x2**
 -  **x2**
 -  **x1**
 -  **x4** | 5,8mm | 15/64" **x4**
 -  **x4**

- 10**
-  **x1**
 -  **x1**
 -  **x1** | 5,8mm | 15/64" **x1**
 -  **x1**



- 11**
-  **x1**
 -  **x1**
 -  **x1** | 5,8mm | 15/64" **x1**
 -  **x1**

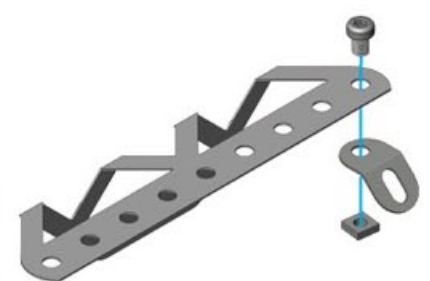

9 + 10 + 11 +

12

	5,8mm	x2
	15/64"	x2

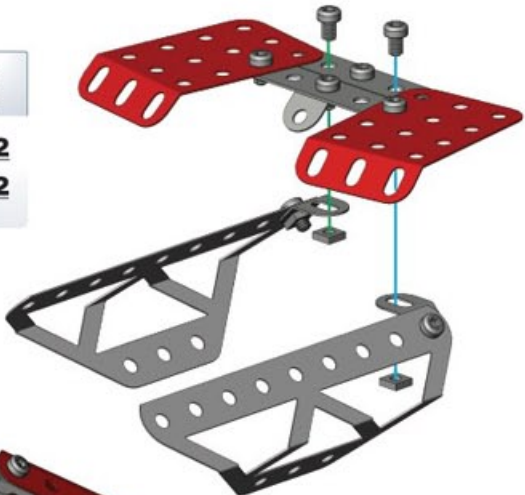



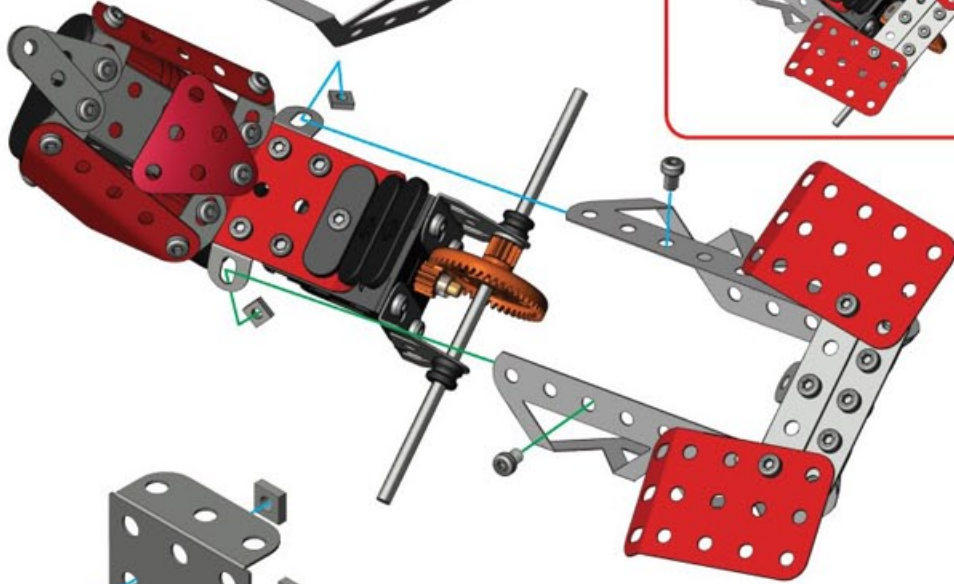

8 + 12 +

13

	5,8mm	x2
	15/64"	x2



14

	x1	
	x2	
	5,8mm	x2
	15/64"	x2

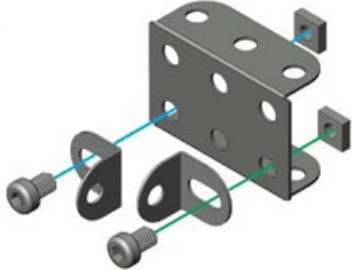





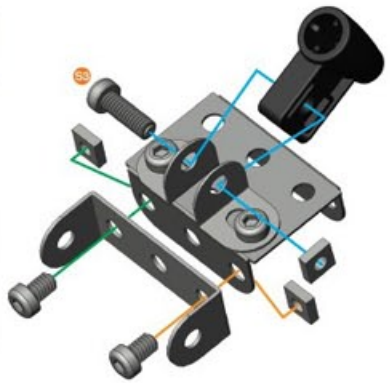



15

	x1	
	x1	
	12mm	x1
	1/2"	x1
	5,8mm	x2
	15/64"	x3



16

	x1	
	x1	
	x1	
	19mm	x1
	3/4"	x1
	12mm	x1
	1/2"	x1
	5,8mm	x2
	15/64"	x3

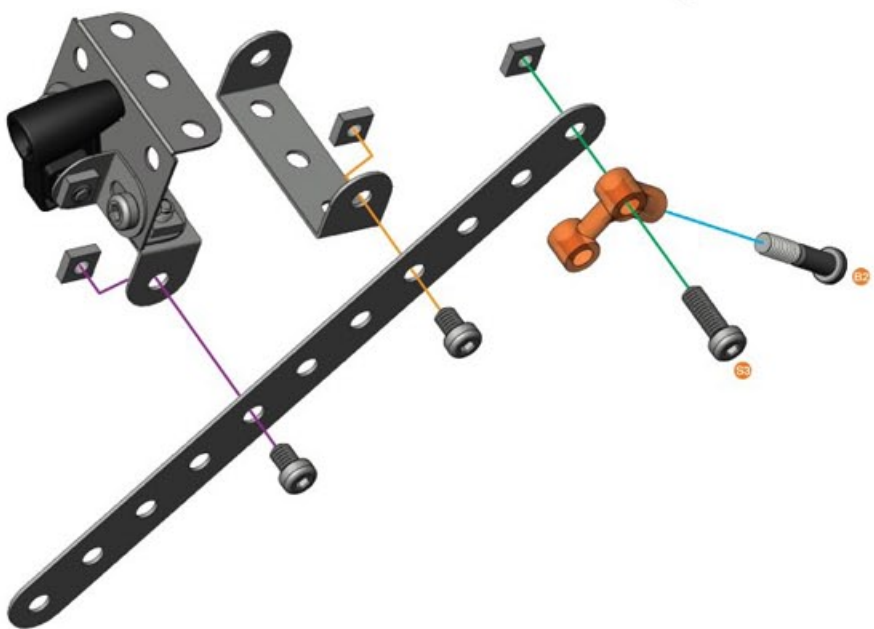

17



x1



x1



19mm 3/4" x1



12mm 1/2" x1



5,8mm 15/64" x2



x3

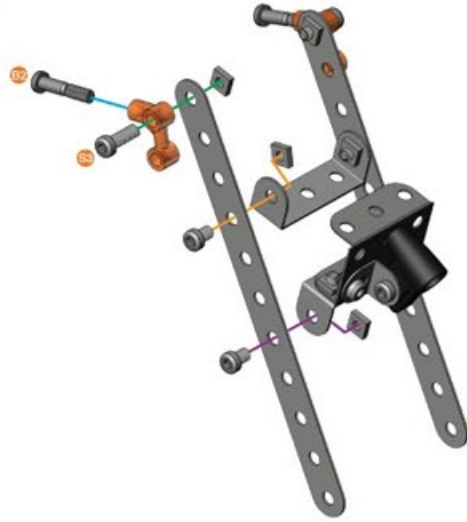

18



x1



x1



x2



x2



38,1mm 1 1/2" x1



x1

13 + 18 +

19



x1



14,7mm 57/64" x1



x1

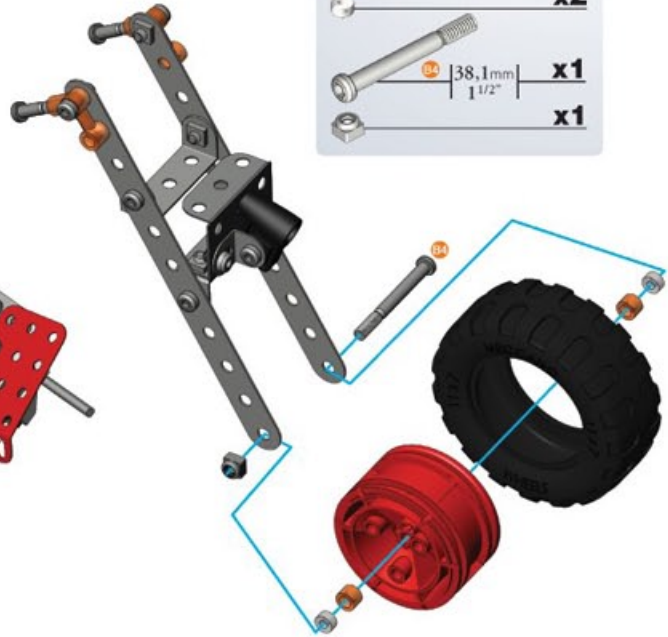
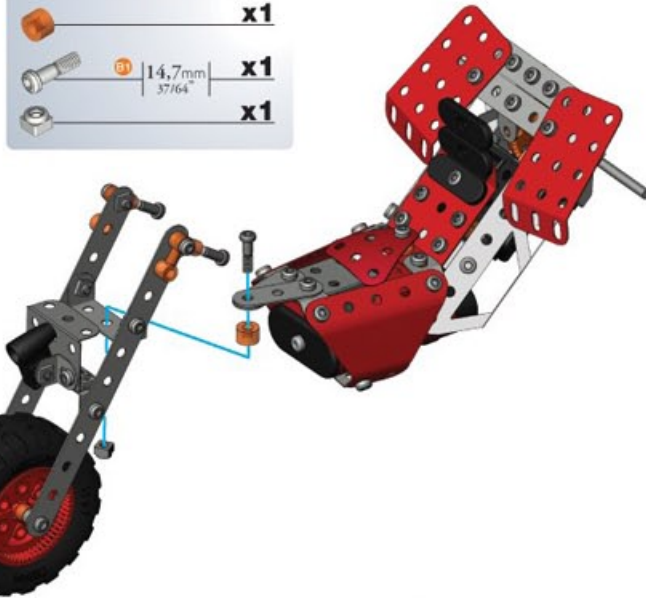

20



x2



x2



x2



x4



x2





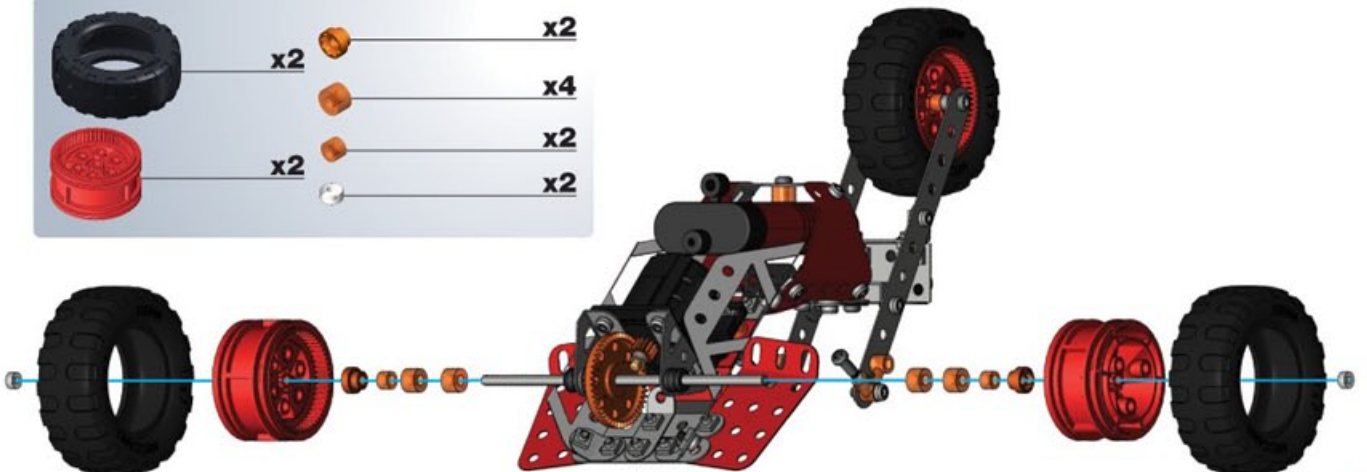



x2











1

-  x1
-  x2
-  x1
-  x1
-  5,8 mm | 15/64" x4
-  5,8 mm | 15/64" x4





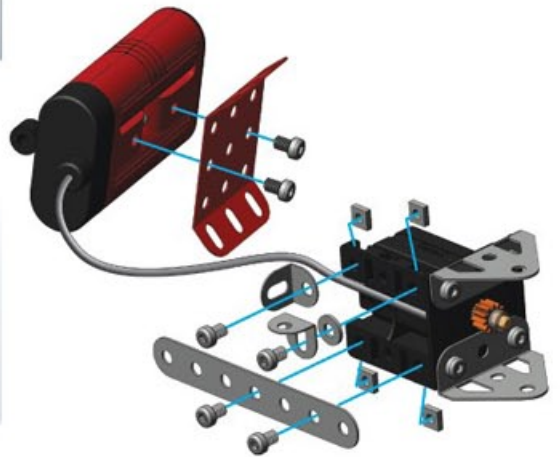

2

-  x1
-  x1
-  x2
-  5,8 mm | 15/64" x6
-  x4
-  x1







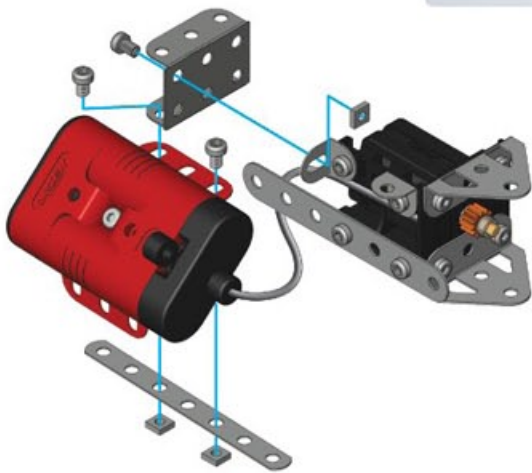

3

-  x1
-  x1
-  5,8 mm | 15/64" x3
-  5,8 mm | 15/64" x3





4

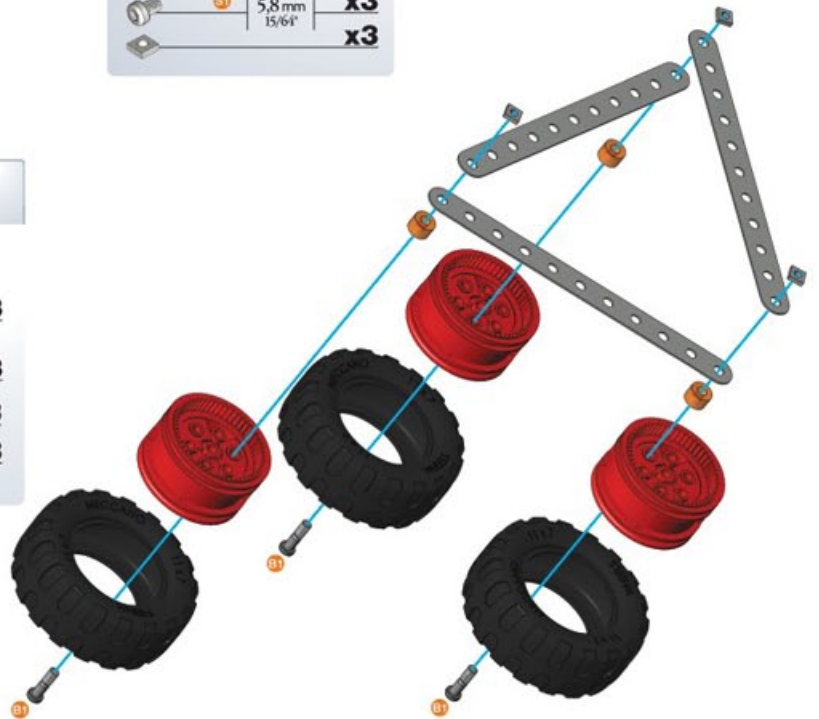

-  x3
-  x3
-  x3
-  x3
-  14,7 mm | 37/64" x3
-  x3



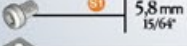
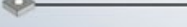

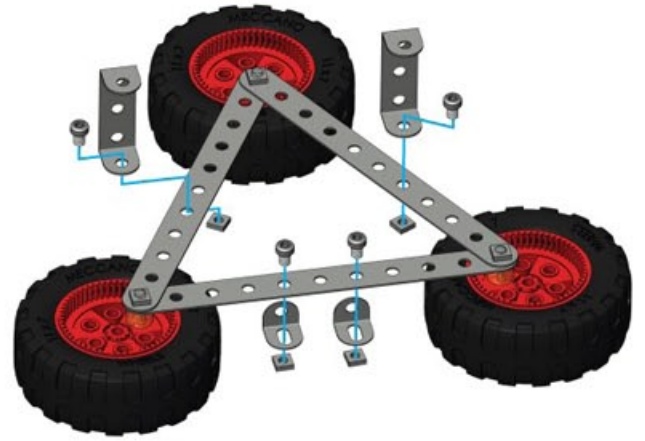
5

-  **x2**
-  **x2**
-  **x4**
-  **x4**



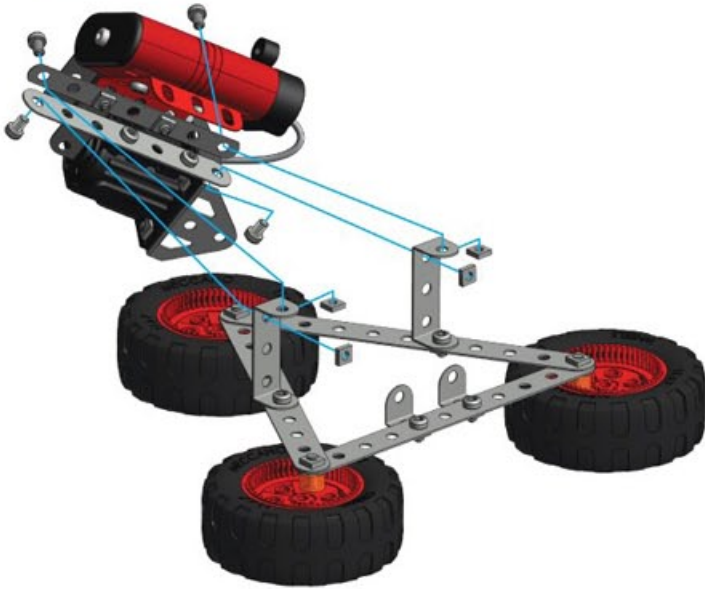

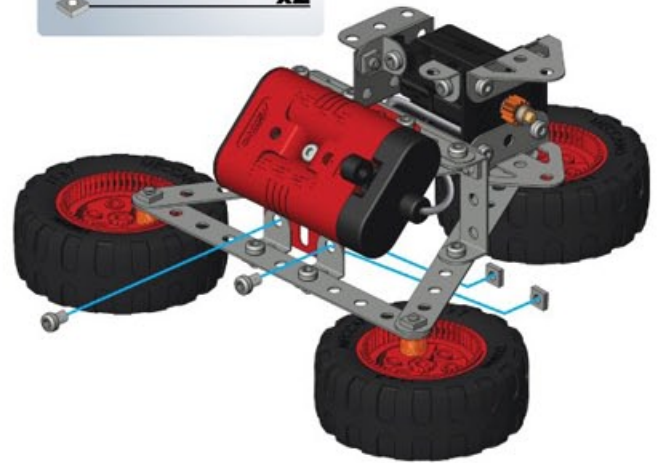

**3 + 5 +****6**

-  **x4**
-  **x4**





**7**

-  **x2**
-  **x2**

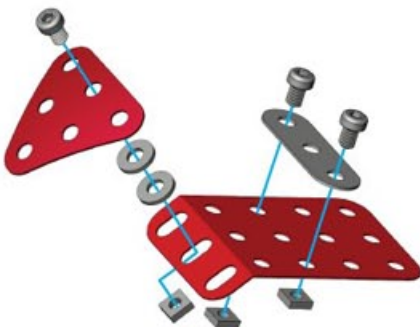
**8**

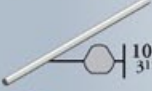

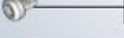

-  **x1**
-  **x1**
-  **x1**
-  **x3**
-  **x3**
-  **x2**

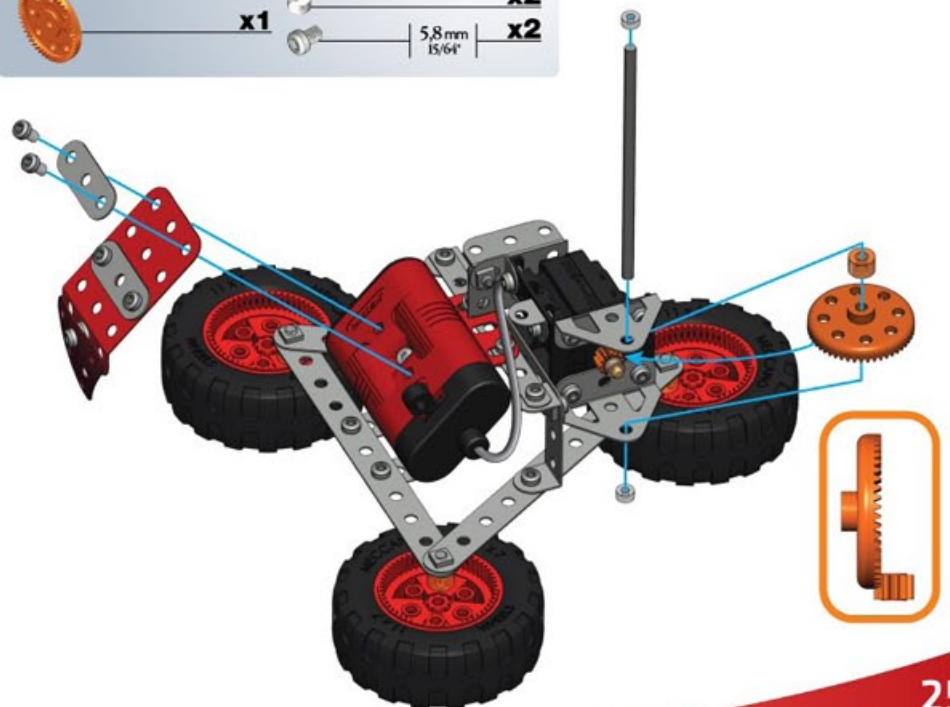
**7 + 8 +****9**





-  **x1**
-  **x1**
-  **x1**
-  **x1**
-  **x2**
-  **x2**



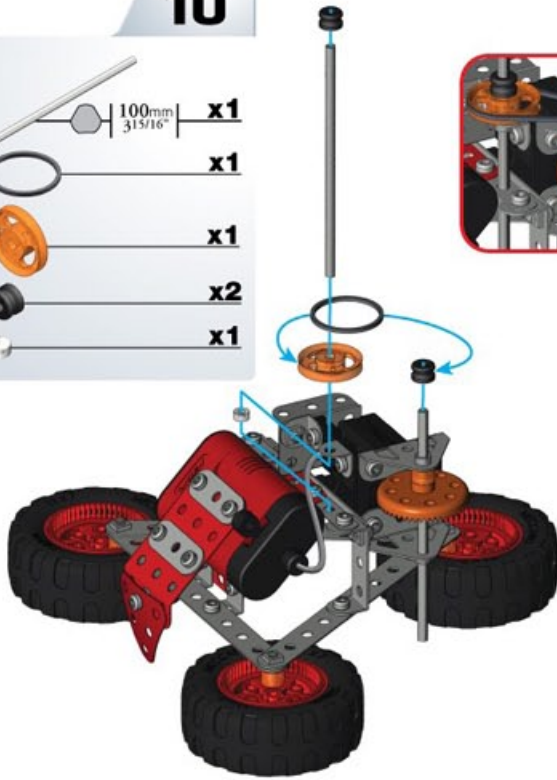



10

-  100mm $\frac{315}{16}$ x1
-  x1
-  x1
-  x2
-  x1

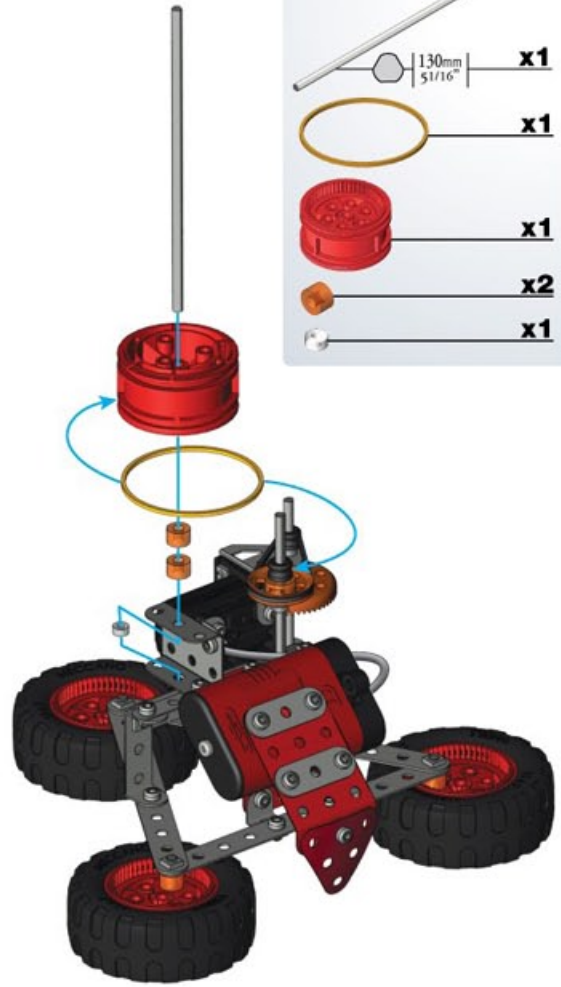

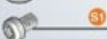

**11**

-  130mm $\frac{51}{16}$ x1
-  x1
-  x1
-  x2
-  x1

**12**

-  x2
-  x4
-  5,8mm $\frac{15}{64}$ x4
-  x4

**13**

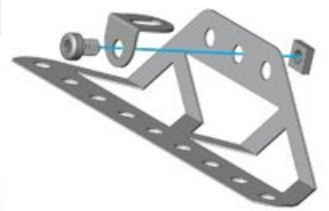

-  x2
-  x2
-  5,8mm $\frac{15}{64}$ x2
-  x2

**14**

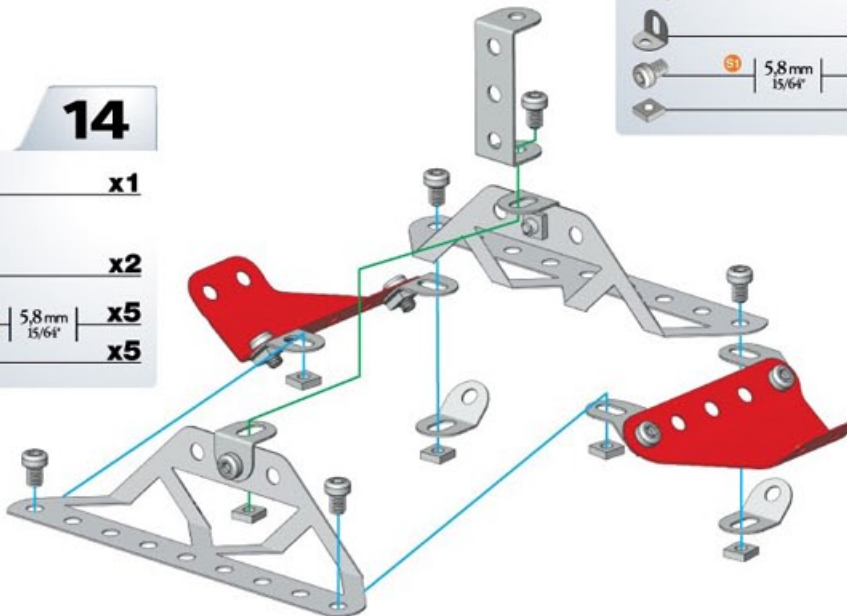
-  (12+13+) x1
-  x2
-  5,8mm $\frac{15}{64}$ x5
-  x5





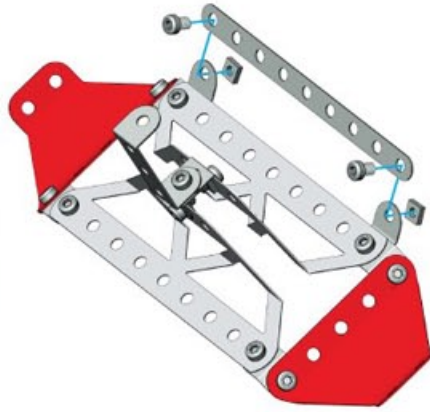

15

-  **x1**
-  **x2**
-  **x2**



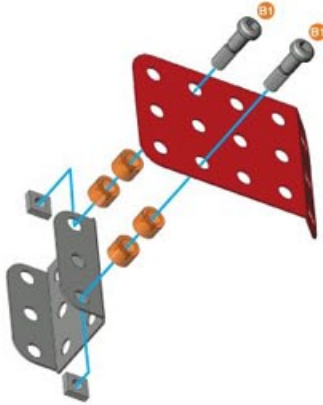

16

-  **x1**
-  **x1**
-  **x4**
-  **x2**
-  **x2**

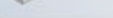

14+15+ **17**

-  **x1**
-  **x1**
-  **x1**
-  **x4**
-  **x5**

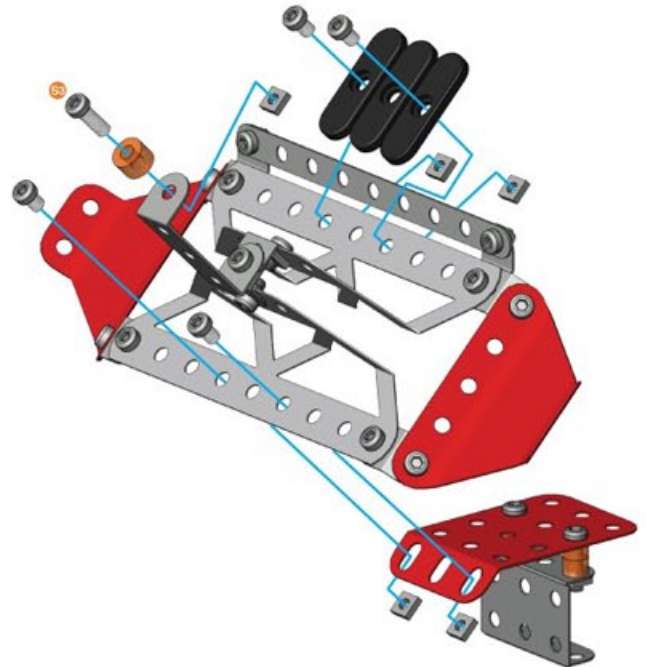

11+17+ **18**

-  **x1**



1

- x1
- x1
- x2
- x1
- x1
- 5,8 mm | 15/64" x5
- x4



2

- x2
- 5,8 mm | 15/64" x2
- x2

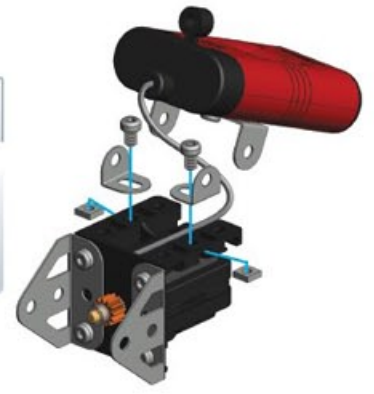

3

- x2
- 130mm | 5 1/8" x1
- x1
- x3
- x2
- 14,7mm | 37/64" x2
- 5,8mm | 15/64" x2
- x4
- x3

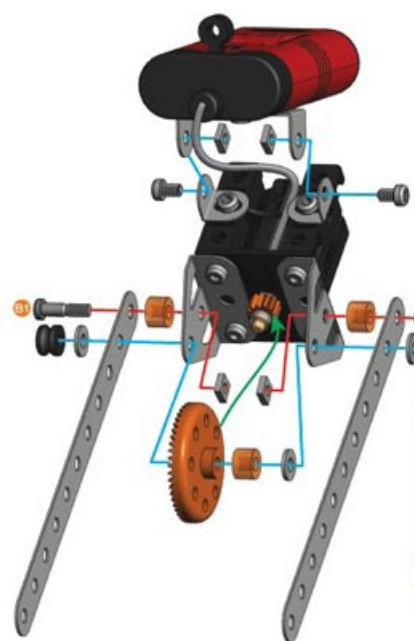

4

- x2
- x2
- x4
- 12mm | 1/2" x4
- x4

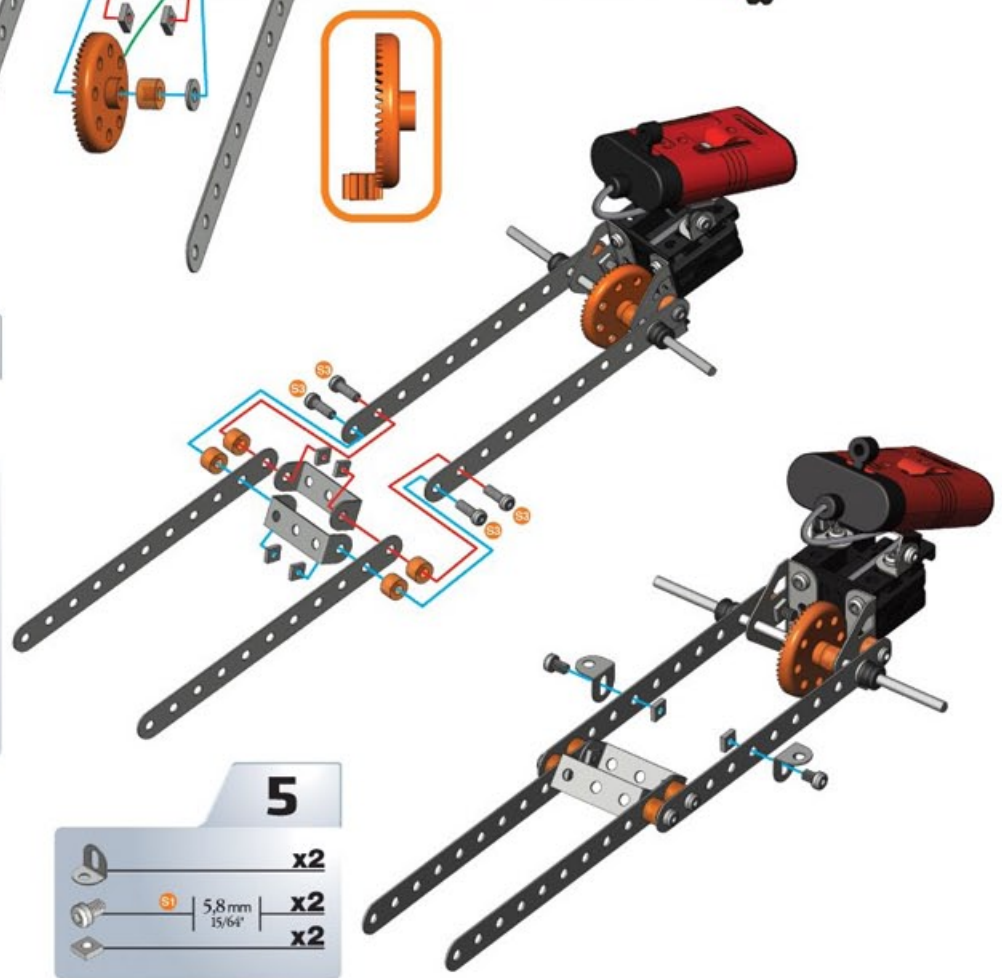

5

- x2
- 5,8mm | 15/64" x2
- x2





6

-  x1
-  x1
-  x1
-  x1
-  x1
-  x3
-  x3

**7**

-  x2
-  x2
-  x2



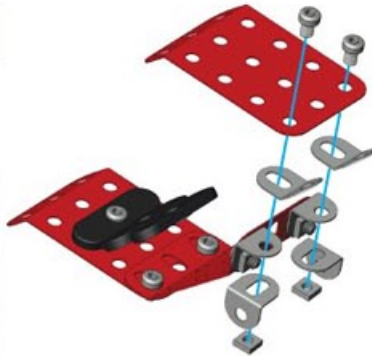

**8**

-  x1
-  x2
-  x2
-  x2
-  x2

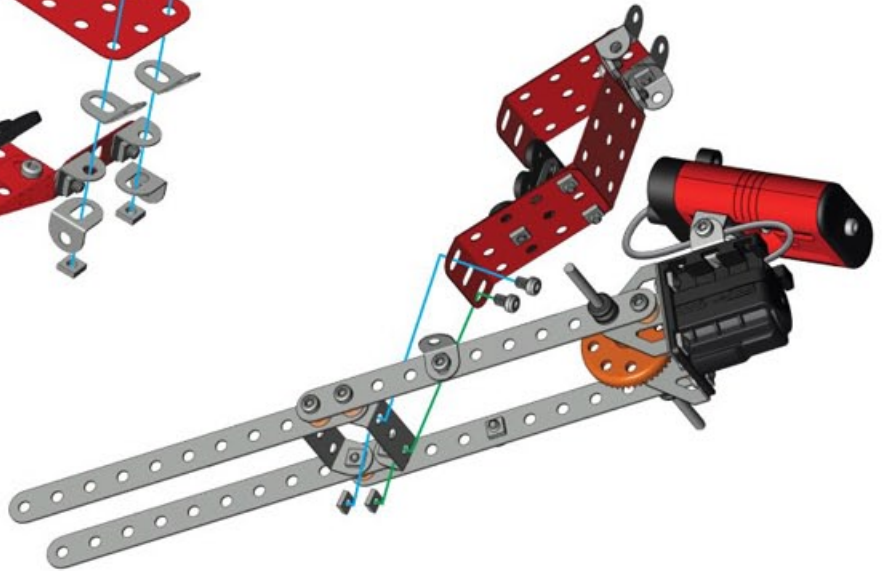
**5 + 8 +****9**

-  x2
-  x2

**10**

-  x1
-  x2
-  x2
-  x2
-  x2

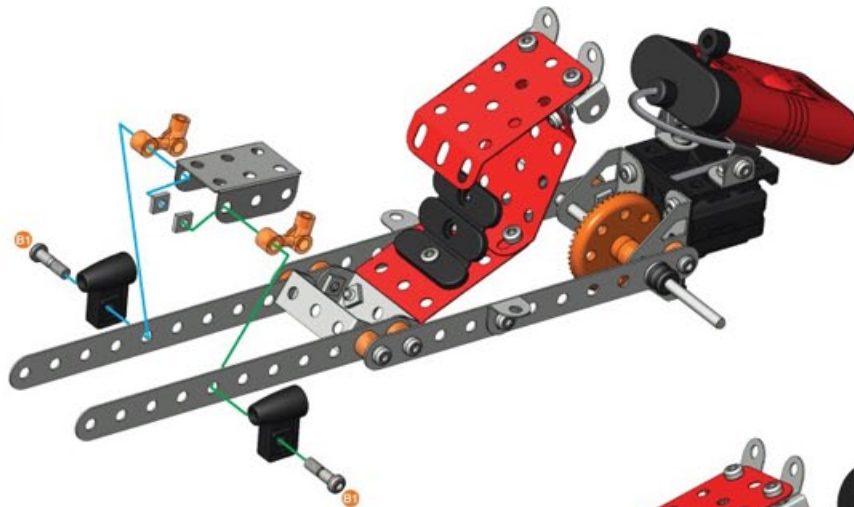
**11**

-  x1
-  x1
-  x1
-  x1

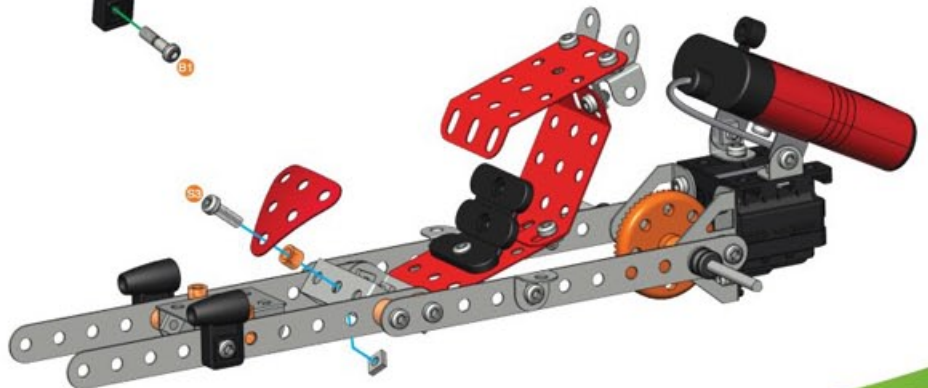

12

x2

x2

x2

x4

x2

11 + **12** +

13

x1

x2

12 + **13** +

14

x1

x2

15

x2

x3

x3

2

1

16

x2

x4

x4

x4

15 + **16** +

17

x1

x1

x1

x1

x1

x1

16+17+

18

	x1		x1
	x1		x1
			x1
			x1

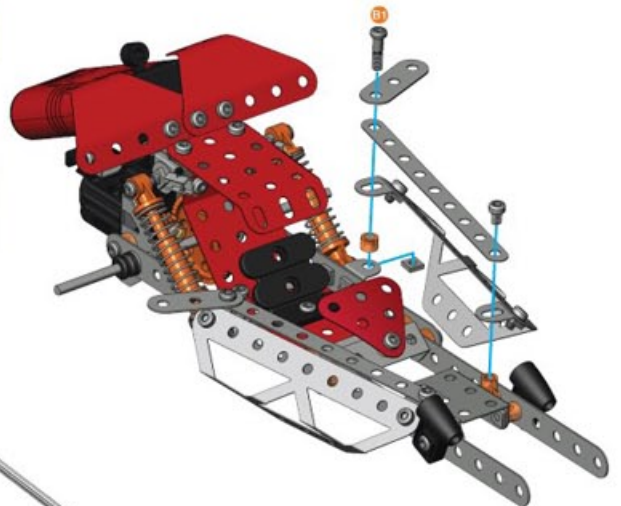

19

	x2
--	----

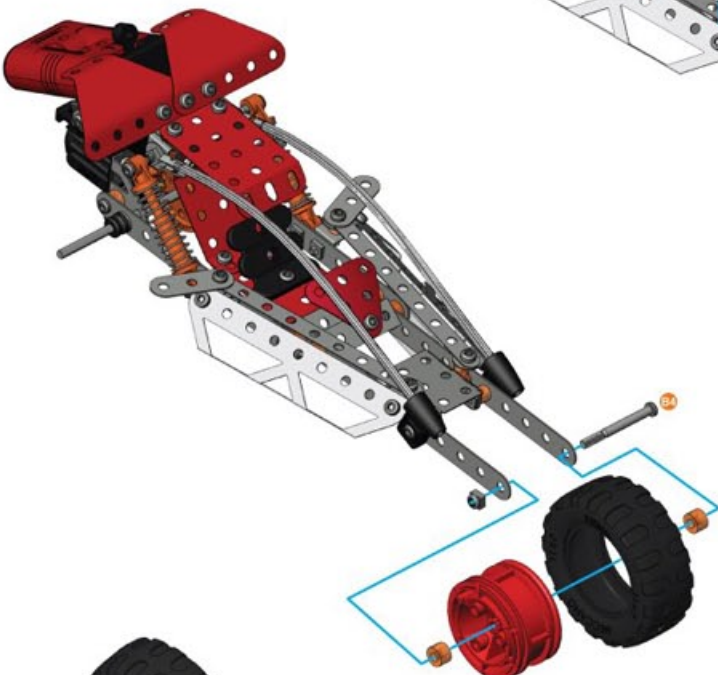
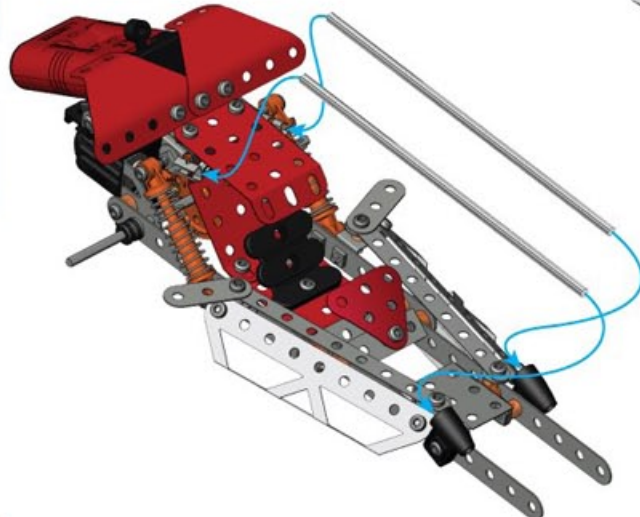

20

	x1		x1
	x1		x2
			x1

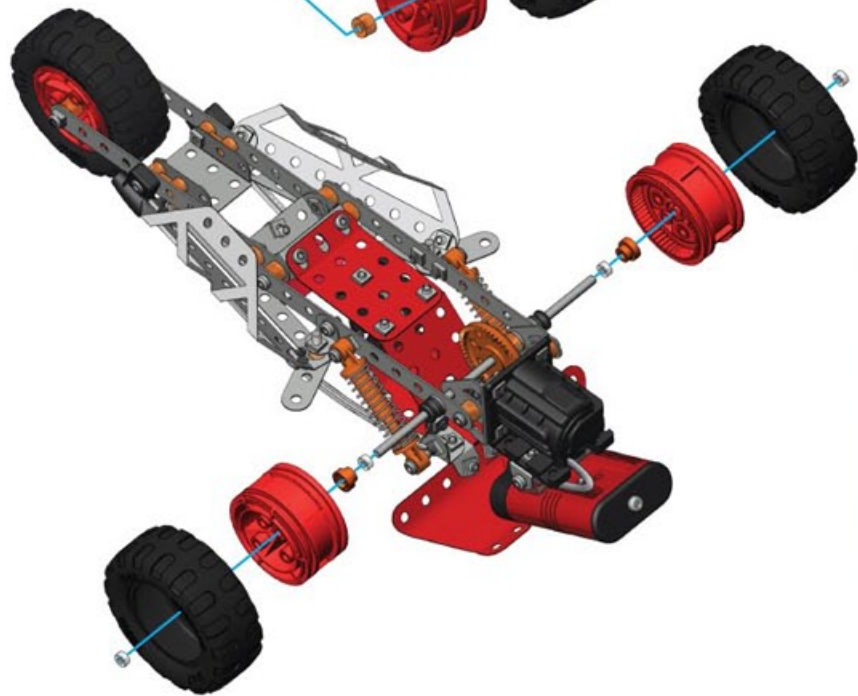

21

	x2
	x2
	x2
	x4



1

-  x1
-  x1
-  x2
-  x1
-  x1
-  x3
-  x2

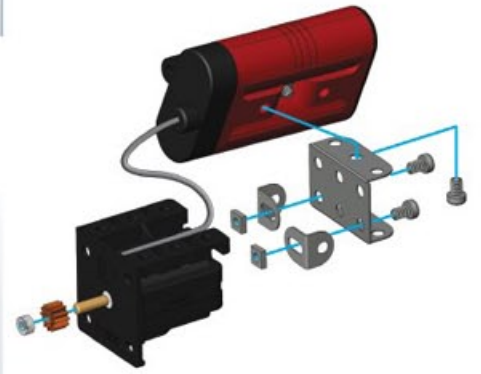



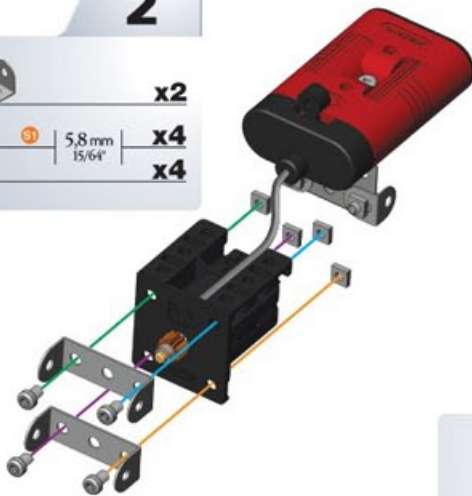

2

-  x2
-  x4
-  x4





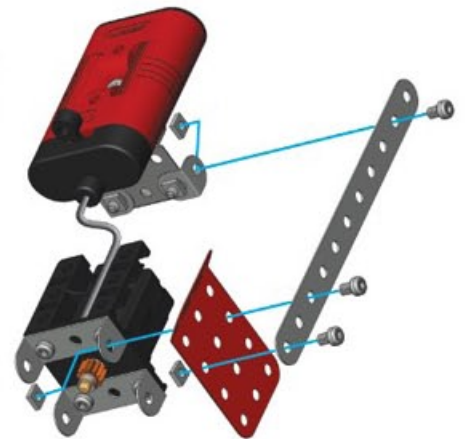

3

-  x1
-  x1
-  x3
-  x3



4

-  x1
-  x1
-  x3
-  x3

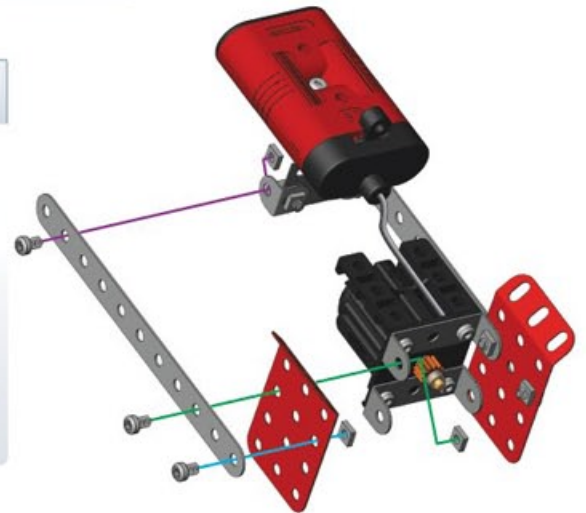

5

-  x1
-  x4
-  x4
-  x4

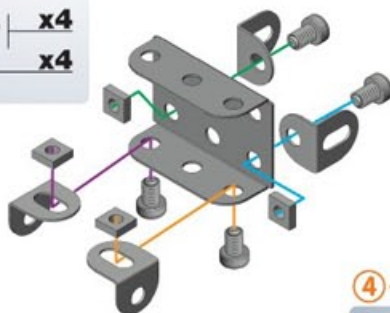



4 + 5 +

6

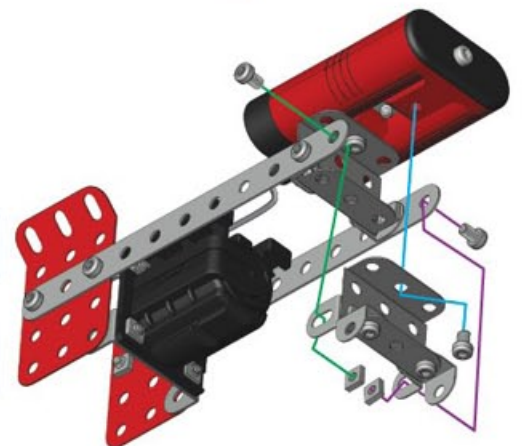



-  x3
-  x2

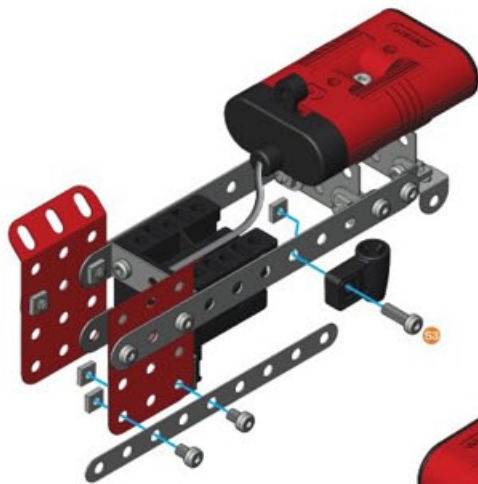

7

-  **x1**
-  **x1**
-  **x1**
-  **x2**
-  **x3**

**8**

-  **x1**
-  **x1**
-  **x1**
-  **x2**
-  **x3**

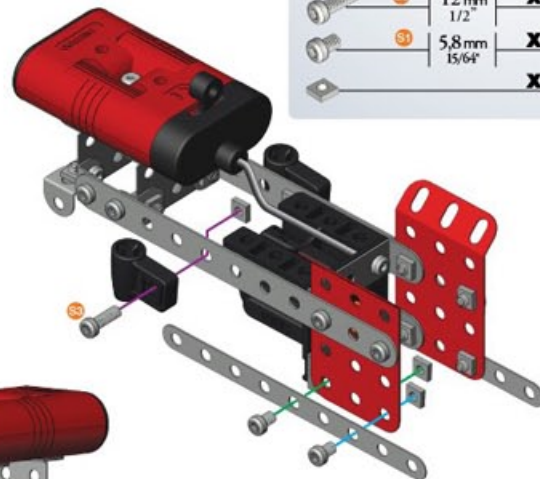

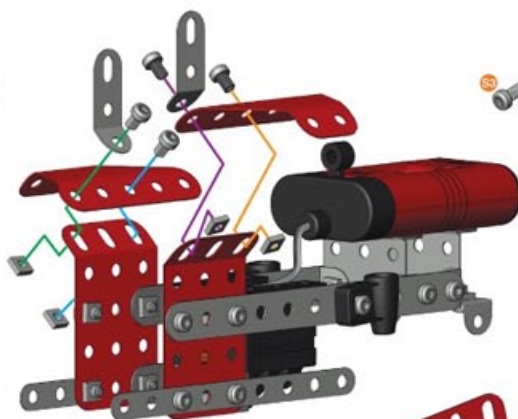

**9**

-  **x2**
-  **x2**
-  **x4**
-  **x4**

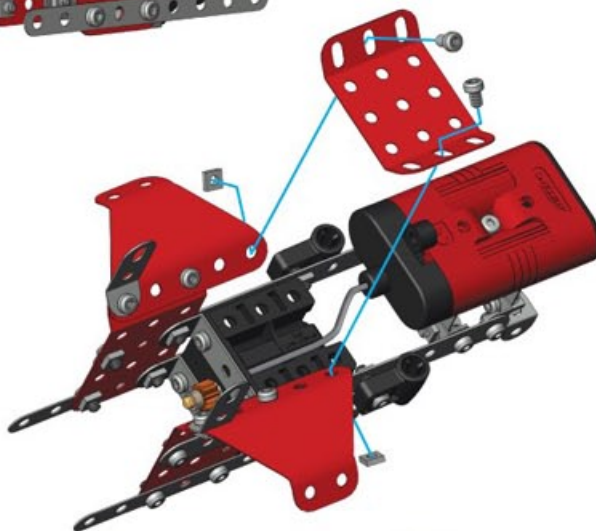
**10**

-  **x1**
-  **x2**
-  **x2**

**11**

-  **x2**
-  **x1**
-  **x2**
-  **x2**
-  **x2**

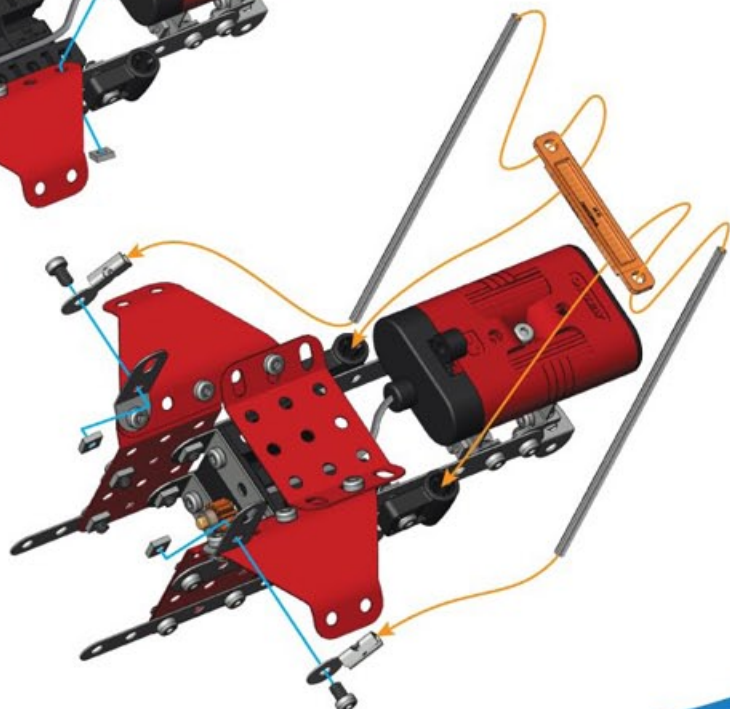



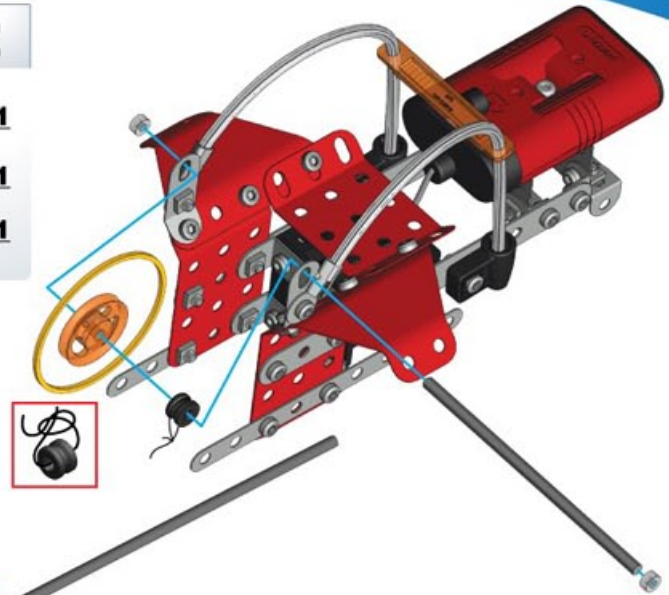

12

-  x1
-  x1
-  x1
-  x1
-  x2
-  x1





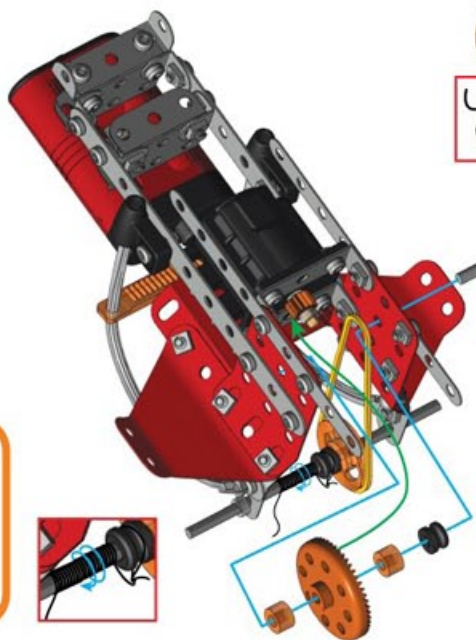

13

-  x1
-  x1
-  x2
-  x1







14

-  x1
-  x4
-  x2
-  x2



15

-  x1
-  x2
-  x2
-  x2
-  x2

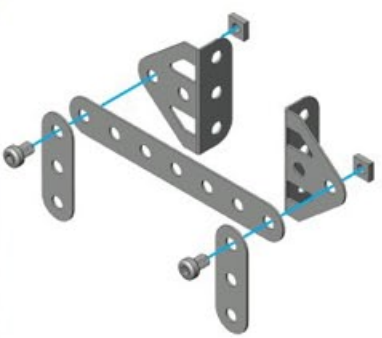

14 + 15 +

16

-  x2
-  x4
-  x4

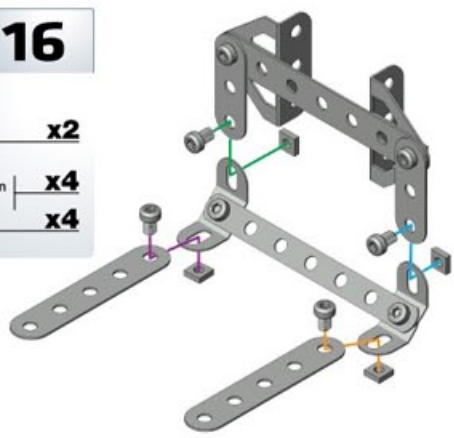

17

-  x4
-  x2
-  x2







x2



16 + 17 +



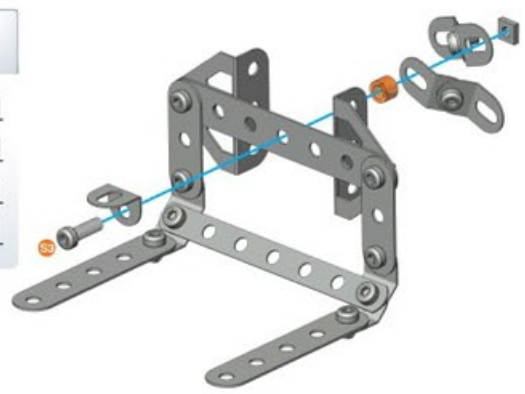

18

-  x1
-  x1
-  x1
-  x1



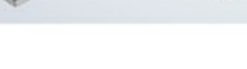

13 + 18 +

19

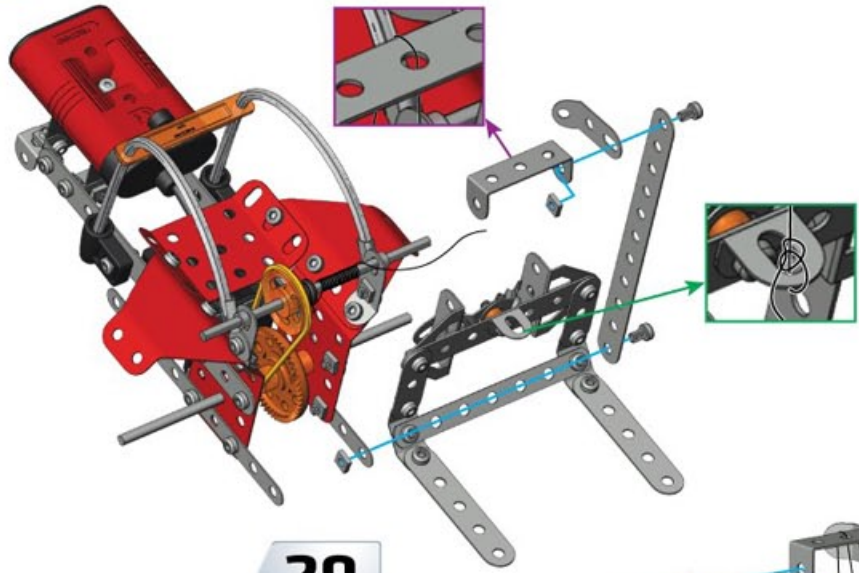
-  x1
-  x1
-  x1
-  x2
-  x2

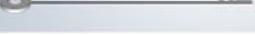

20

-  x1
-  x2
-  x2
-  x2

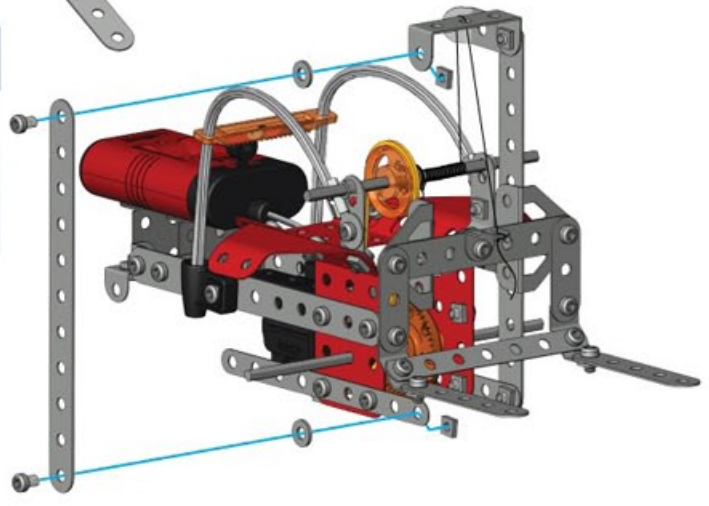

21

-  x2
-  x2
-  x2
-  x2
-  x2
-  x2

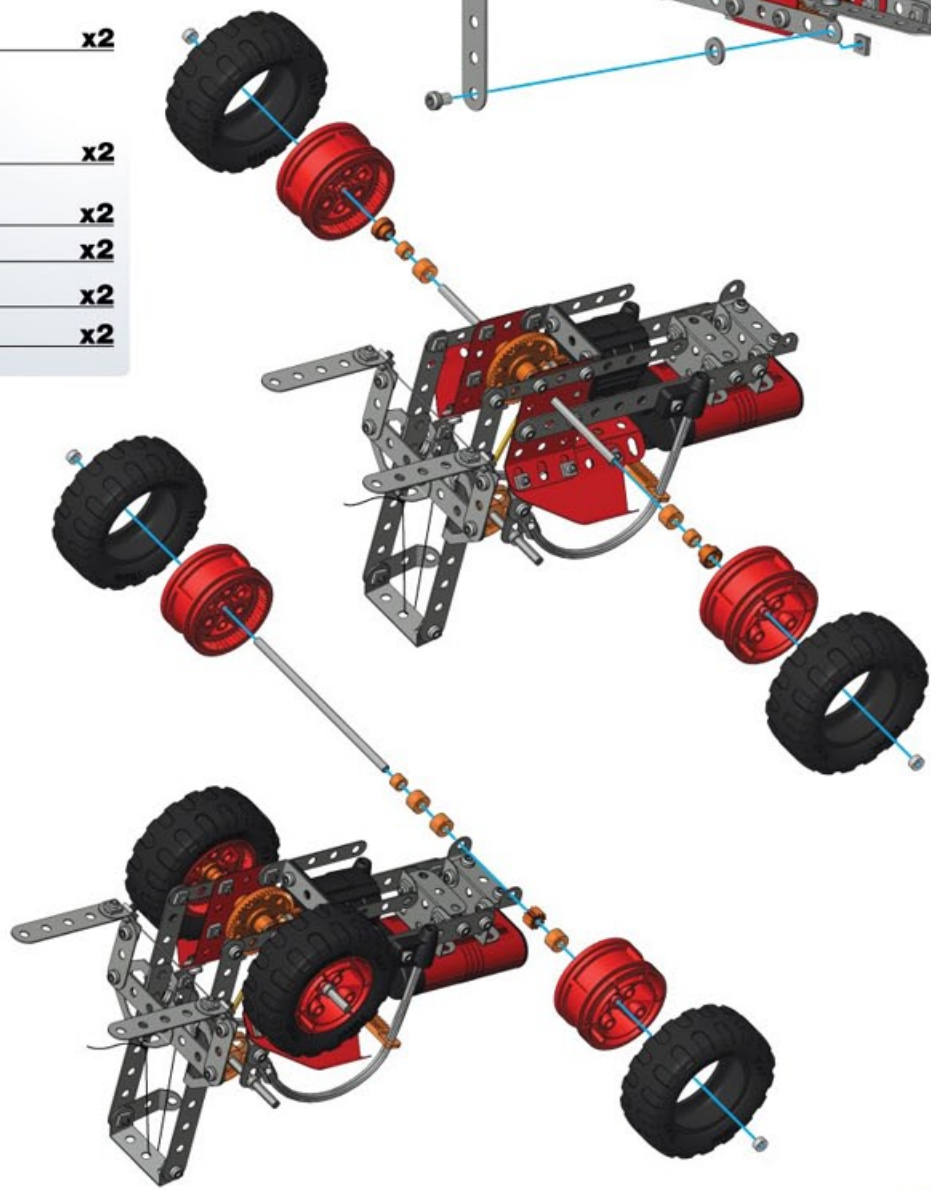





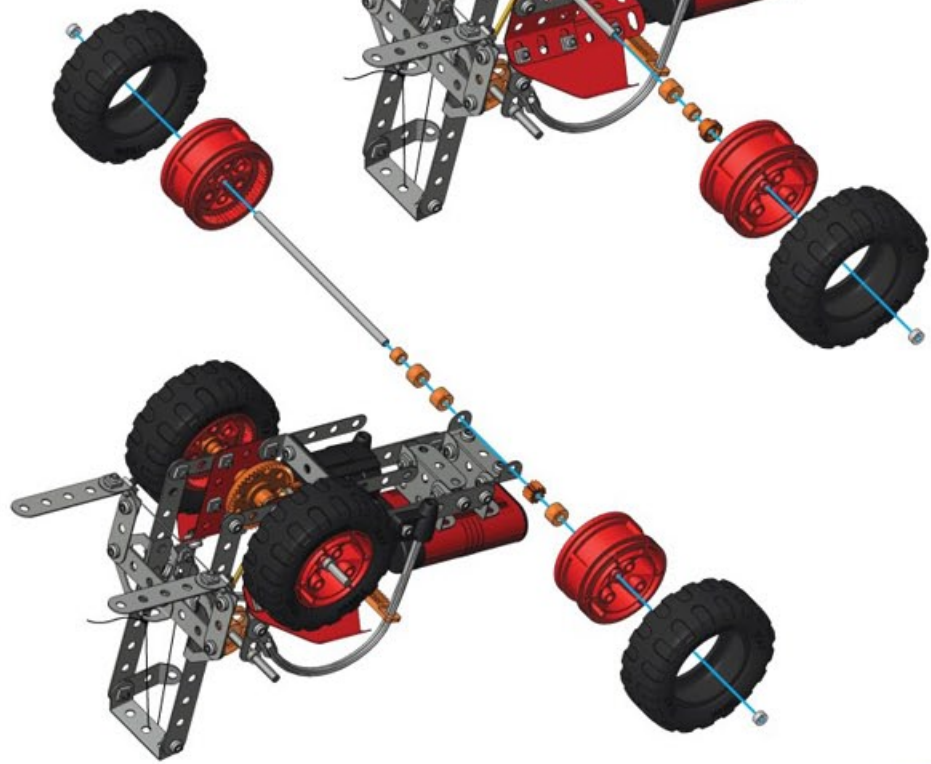







22

-  x1
-  x2
-  x2
-  x2
-  x1
-  x3
-  x1





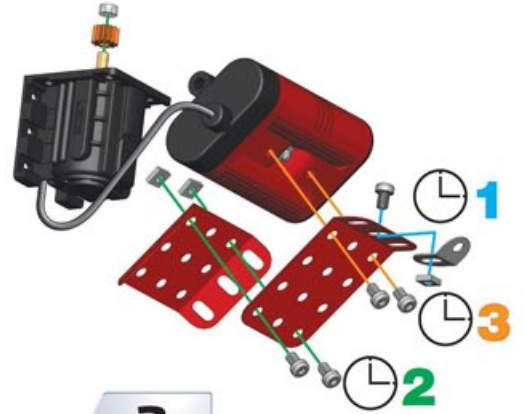

1

-  x1
-  x1
-  x1
-  x1
-  x1
-  x1
-  x1
-  x1
-  x1
-  x1
-  x1
-  x1









2

-  x2
-  x4
-  x4





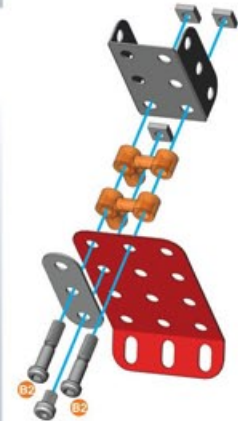

3



-  x1
-  x1
-  x1
-  x2
-  x2
-  x1
-  x3

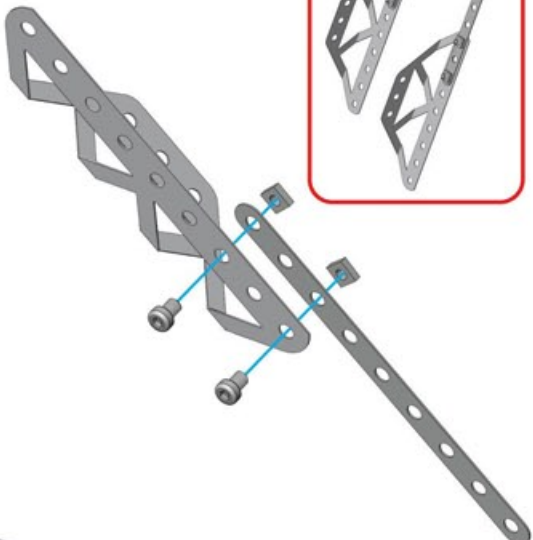

4

-  x2
-  x2
-  x4
-  x4



- 5**
-  x1
 -  x5
 -  x5

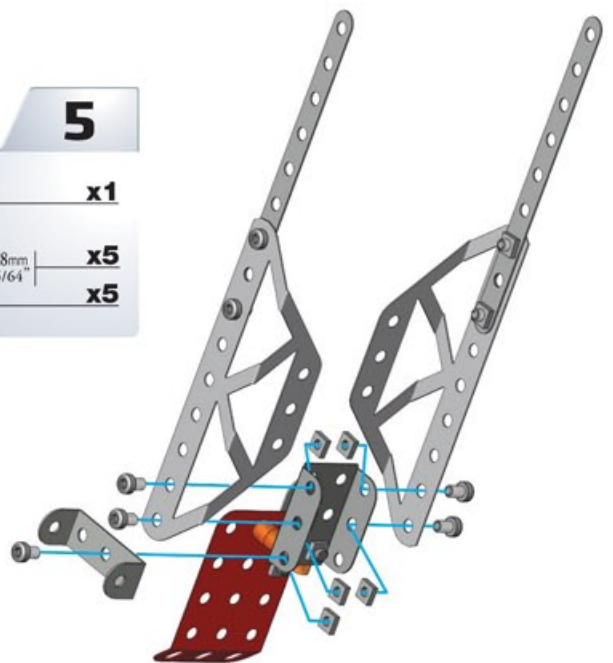

- 2 + 5 +**
- | | |
|--|-----------|
| | x1 |
| | x3 |
| | x3 |

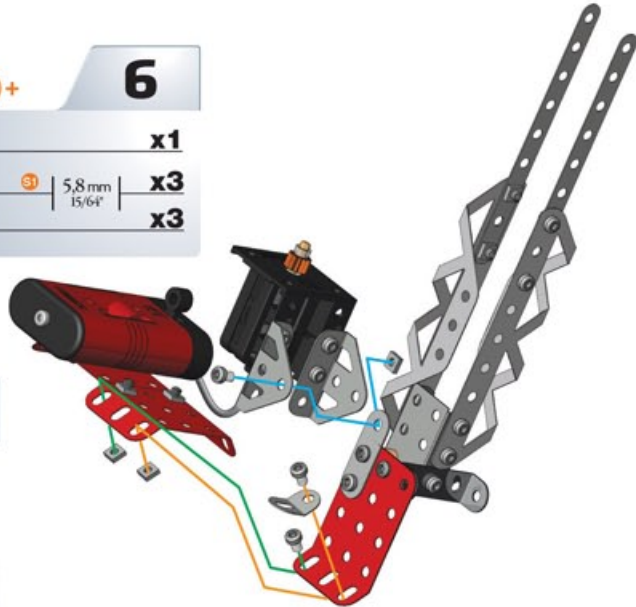

- 7**
- | | |
|--|-----------|
| | x1 |
| | x1 |
| | x2 |
| | x1 |
| | x6 |
| | x6 |

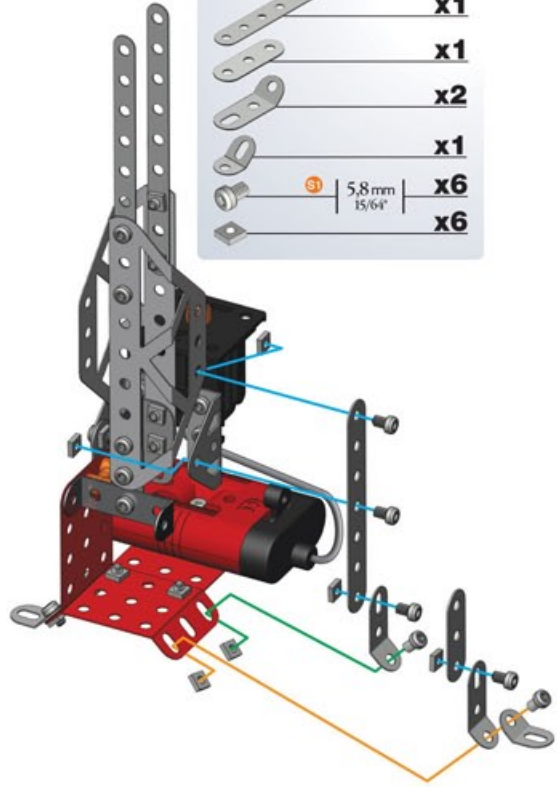

- 8**
- | | |
|--|-----------|
| | x1 |
| | x2 |
| | x2 |

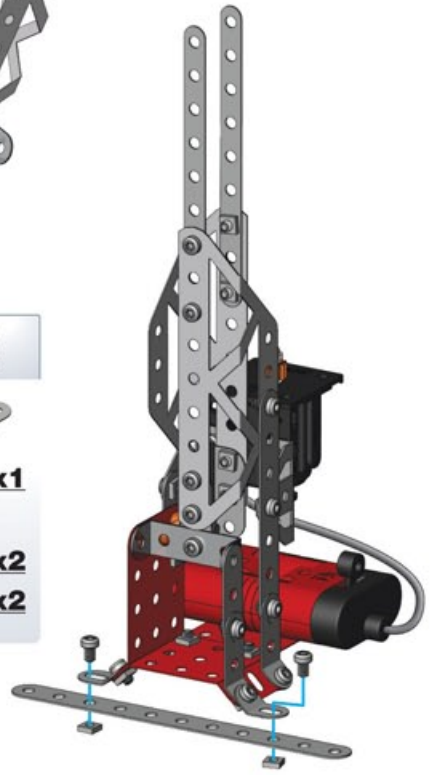

- 9**
- | | |
|--|-----------|
| | x2 |
| | x2 |
| | x2 |

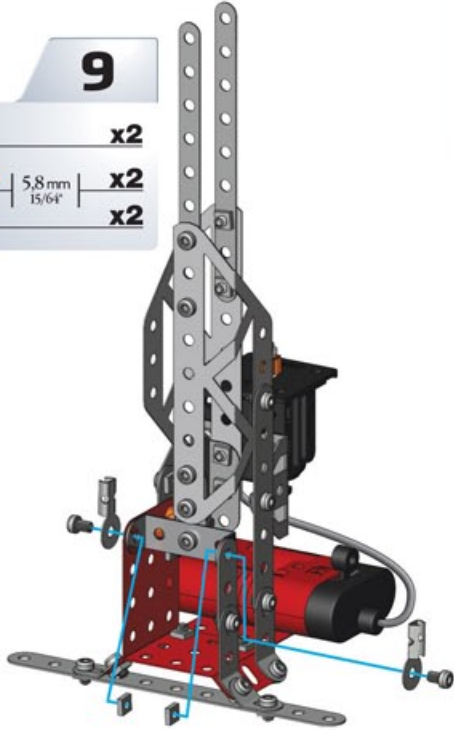

- 10**
- | | | | |
|--|-----------|--|-----------|
| | x3 | | x3 |
| | x3 | | x3 |
| | x3 | | x3 |

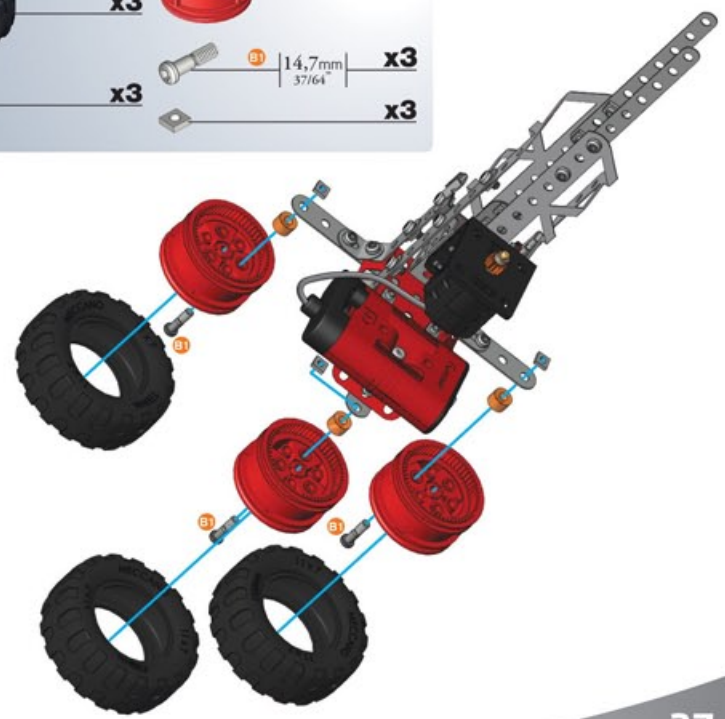

11

- x1** [1-hole grey Technic beam, 10 holes]
- x2** [grey Technic bush]
- x2** [grey Technic pin, 5.8mm / 15/64"]
- x2** [grey Technic axle pin]

12

- x2** [grey Technic L-shaped beam, 2 holes]
- x2** [grey Technic bush]
- x2** [grey Technic pin, 5.8mm / 15/64"]
- x2** [grey Technic axle pin]

13

- x2** [red Technic curved plate]
- x2** [grey Technic pin, 5.8mm / 15/64"]
- x2** [grey Technic axle pin]

14

- x1** [grey Technic L-shaped beam, 2 holes]
- x2** [grey Technic bush]
- x4** [grey Technic pin, 5.8mm / 15/64"]
- x4** [grey Technic axle pin]

15

10 + 14 +

- x4** [grey Technic pin, 5.8mm / 15/64"]
- x4** [grey Technic axle pin]

17

15 + 16 +

- x2** [grey Technic axle pin]
- x1** [grey Technic pin, 12mm / 1/2"]
- x1** [grey Technic bush]
- x1** [grey Technic axle pin]

16

- x1** [black Technic bush]
- x2** [black Technic bush]
- x2** [grey Technic pin, 12mm / 1/2"]
- x2** [grey Technic axle pin]

18

	x3		x1
	x3		x3
			x3

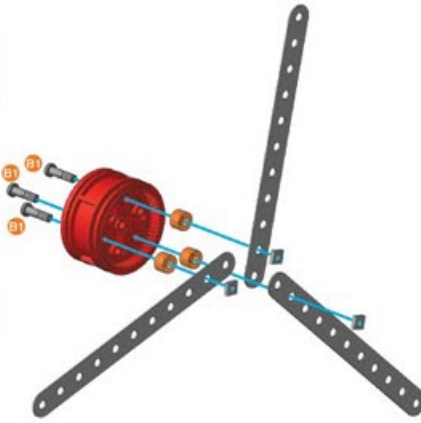

17 + 18 +

19

	x1
	x1
	x1
	x1
	x2



20

	x1
	x1
	x1
	x1
	x2



21

	x1
	x1
	x1
	x1
	x3

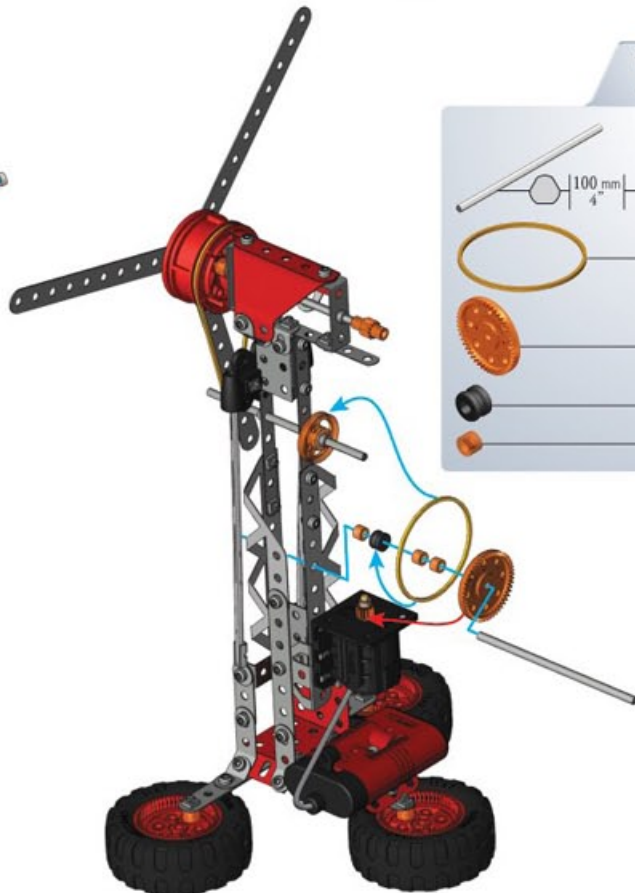







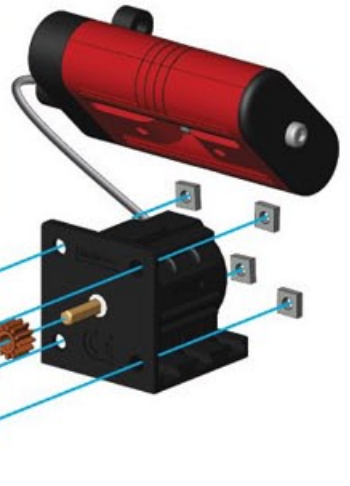







1

-  x2
-  x2
-  x1
-  x1
-  5,8 mm | 15/64" x4
-  5,8 mm | 15/64" x4





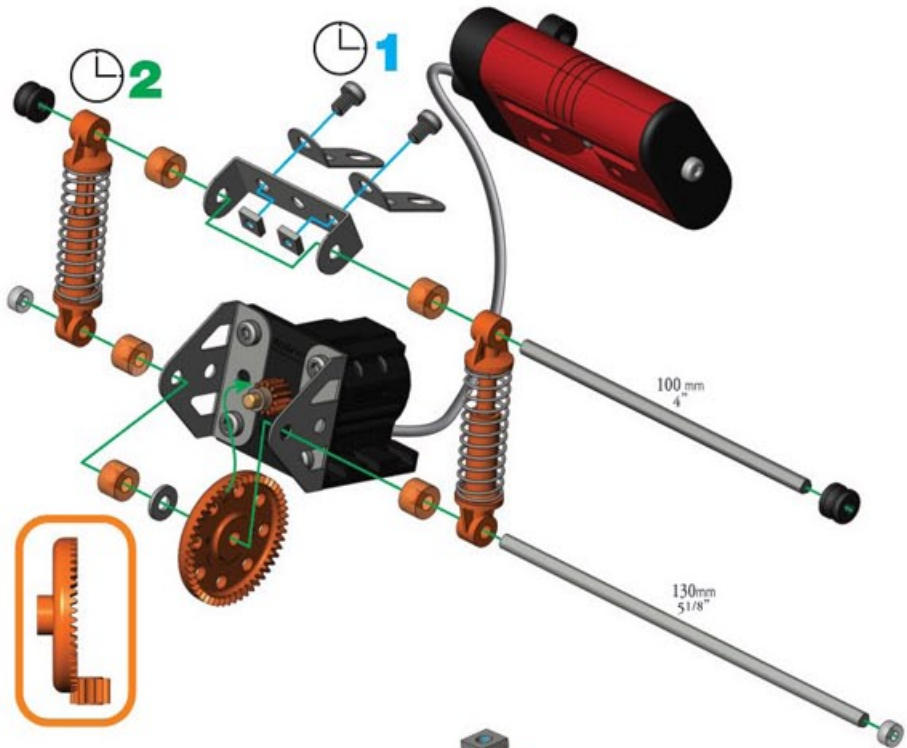

2

-  130 mm | 5 1/8" x1
-  100 mm | 4" x1
-  x2
-  x1
-  x2
-  x2
-  x1
-  x4
-  x2
-  5,8 mm | 15/64" x2
-  5,8 mm | 15/64" x2
-  5,8 mm | 15/64" x1



3

-  x1
-  x1
-  x2
-  5,8 mm | 15/64" x4
-  5,8 mm | 15/64" x4

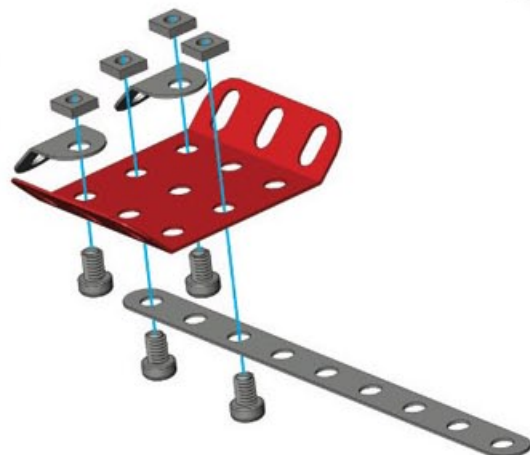

② + ③ +

4

- 5,8mm | 15/64" | x4
- x2



5

- x1
- x1
- x1
- 14,7mm | 37/64" | x4
- 5,8mm | 15/64" | x2
- x2
- x4

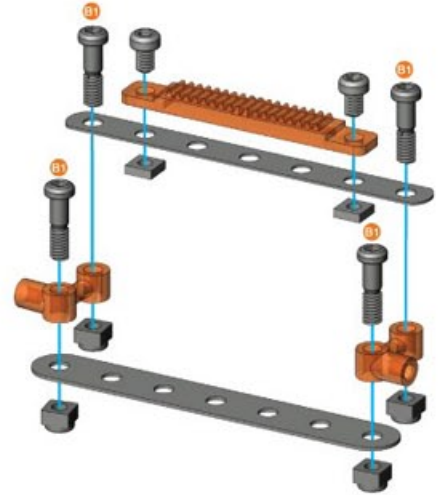

④ + ⑤ +

6

- x2
- 5,8mm | 15/64" | x5
- x5

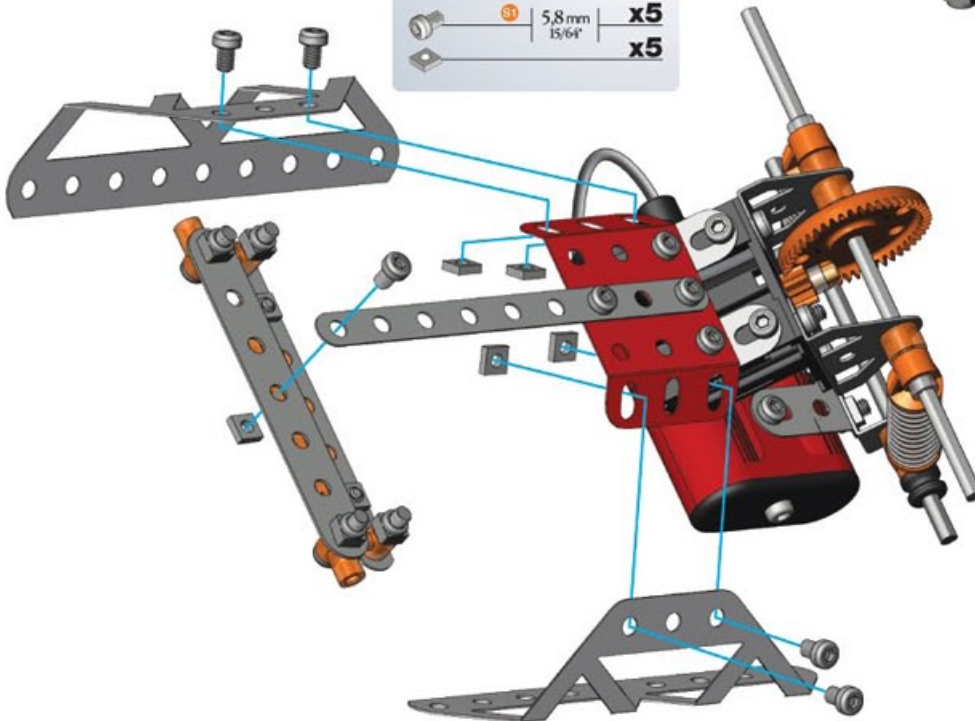

7

- x1
- x2
- x2
- x1
- 38,1mm | 1 1/2" | x1
- 12mm | 1/2" | x2
- x2

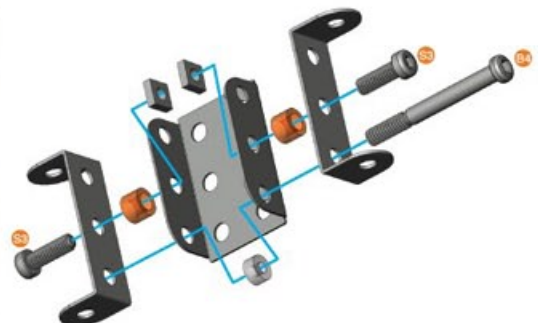

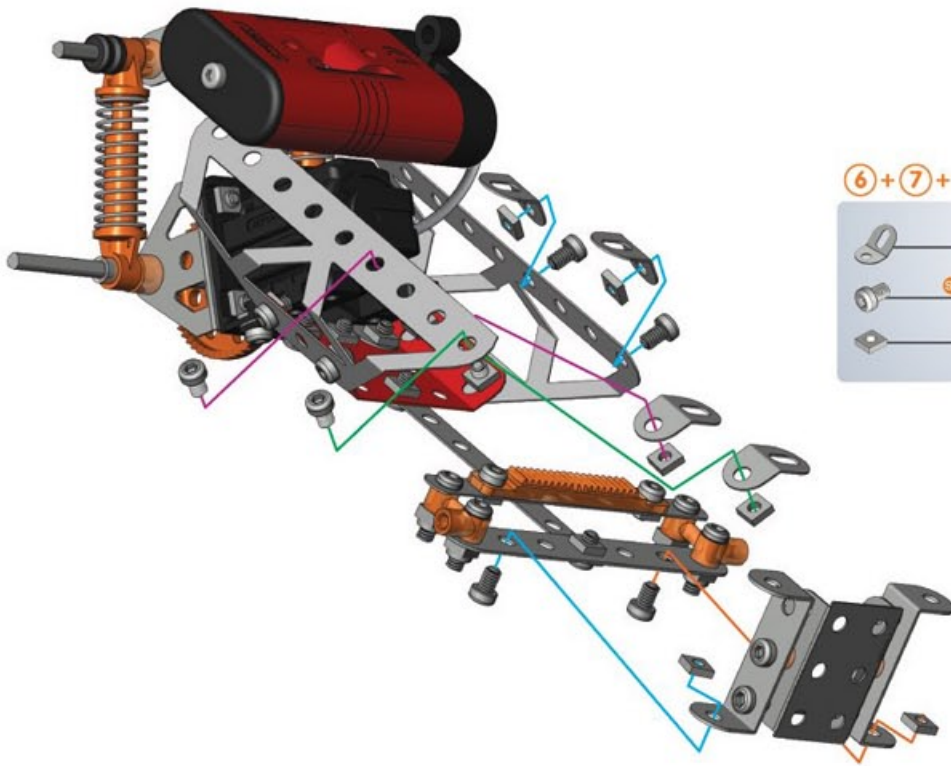

8

⑥ + ⑦ +

	x4
	x6
	x6

9

	x2
	x1
	x1
	x6
	x6

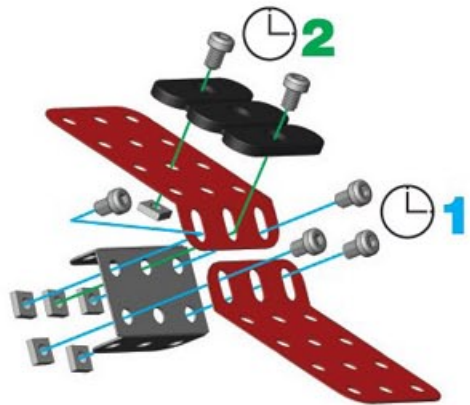

10

	x2
	x1
	x2
	x2
	x2
	x2
	x2
	x2
	x6

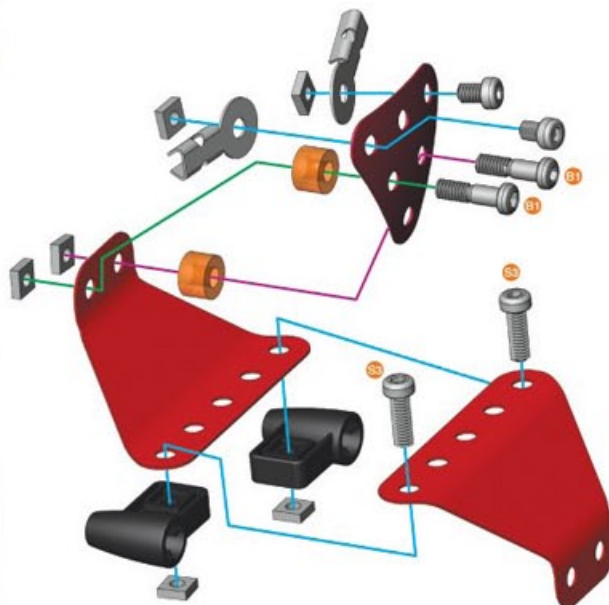

8 + 9 + 10 +

11

-  x2
-  x10
-  x8

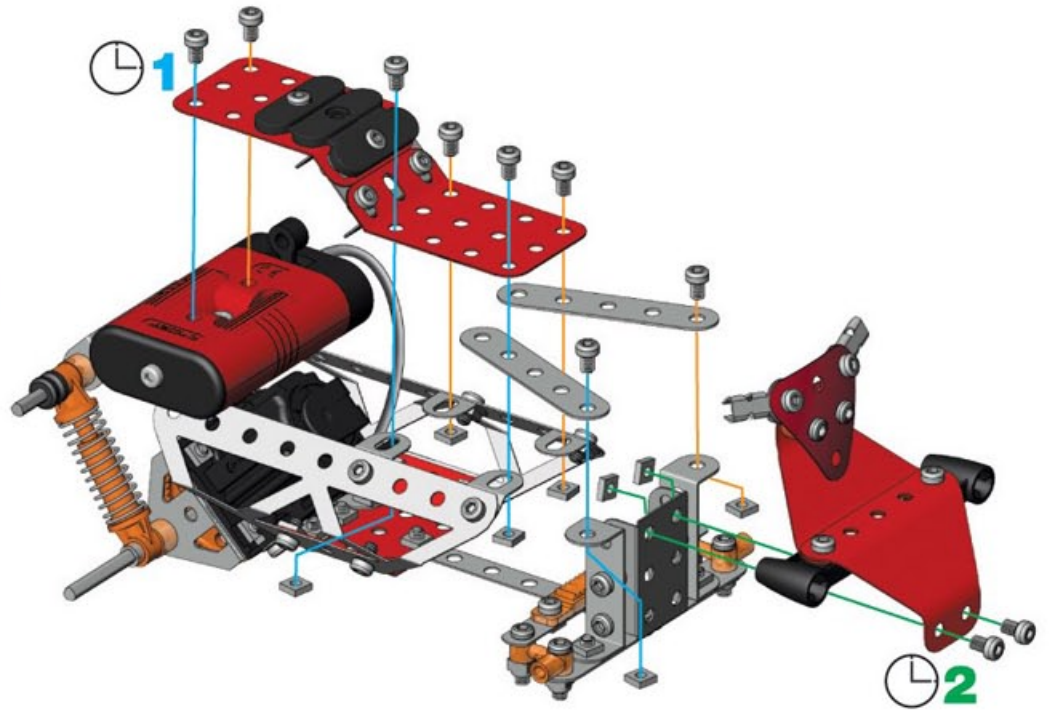

12

-  x4
-  x4
-  x2
-  x2
-  x2
-  x2

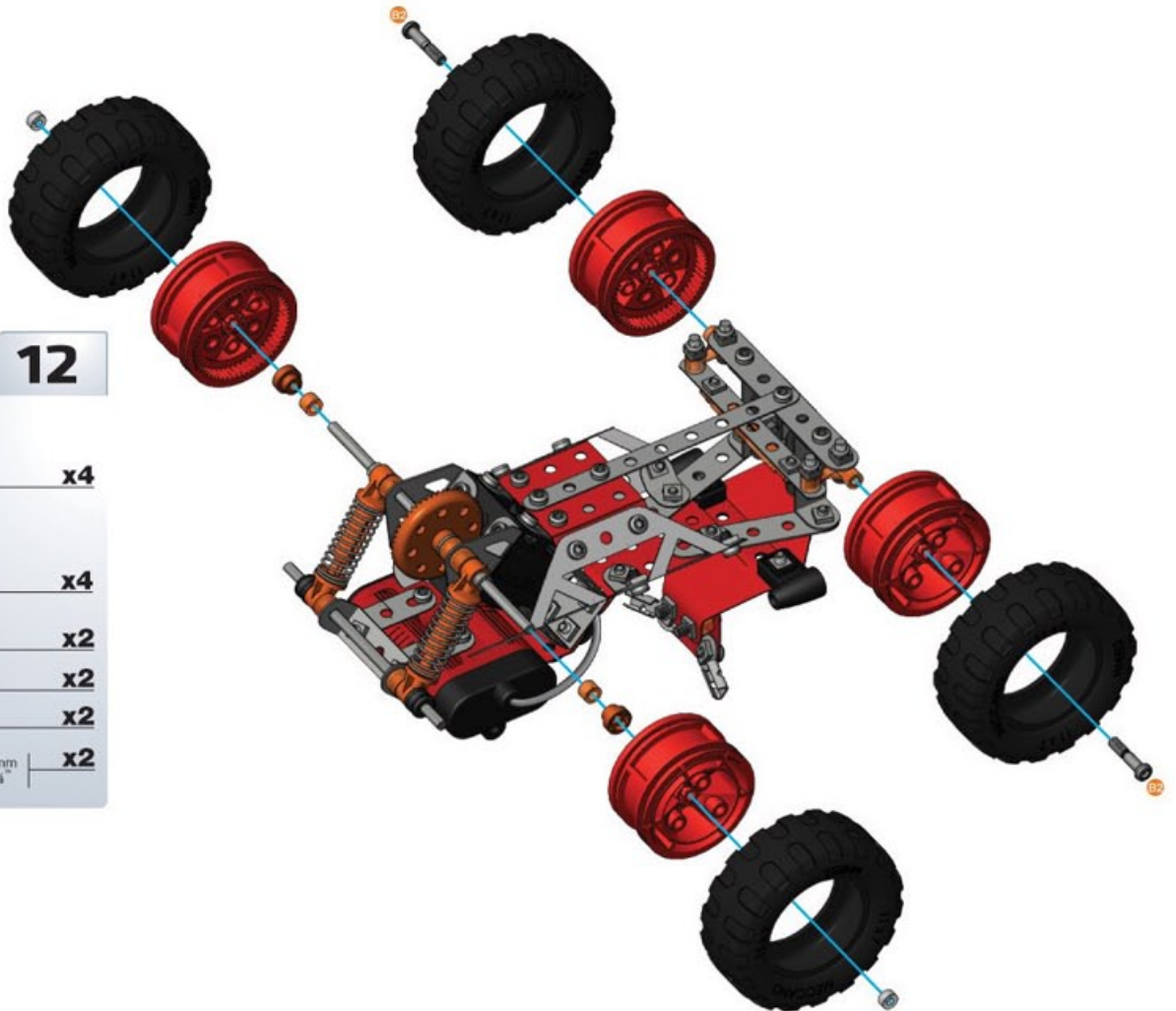



1

	x1		x2
	x1		x1
	x1		x1
	x2		x6
			x6



2

	x2
	x1
	x2
	x6
	x6





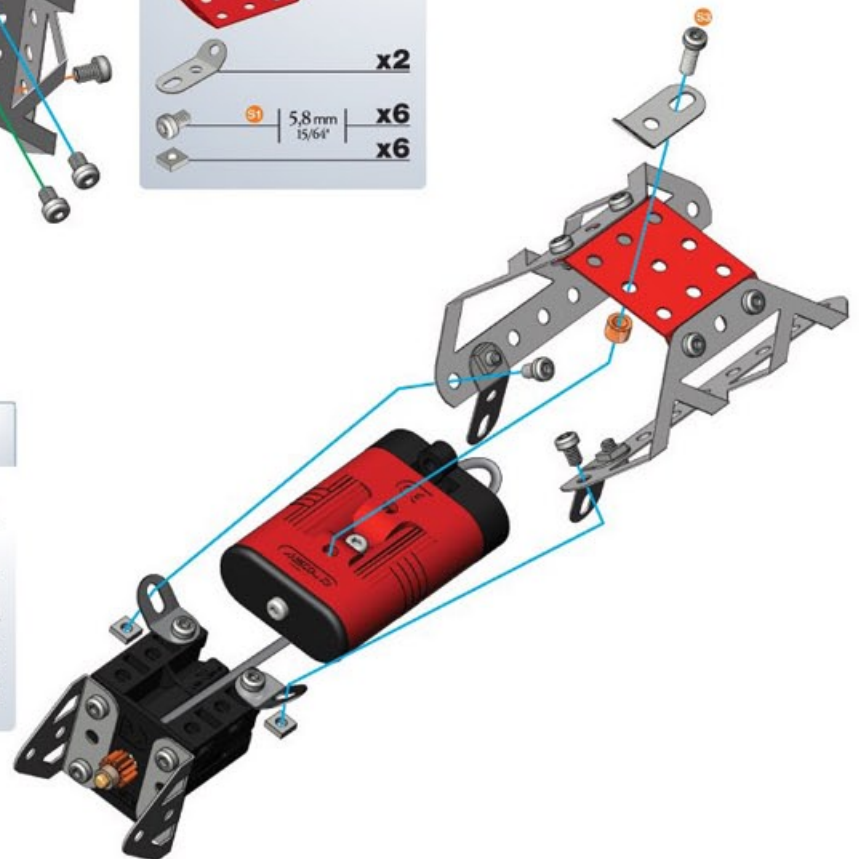

3

	x1
	x1
	x1
	x2
	x2





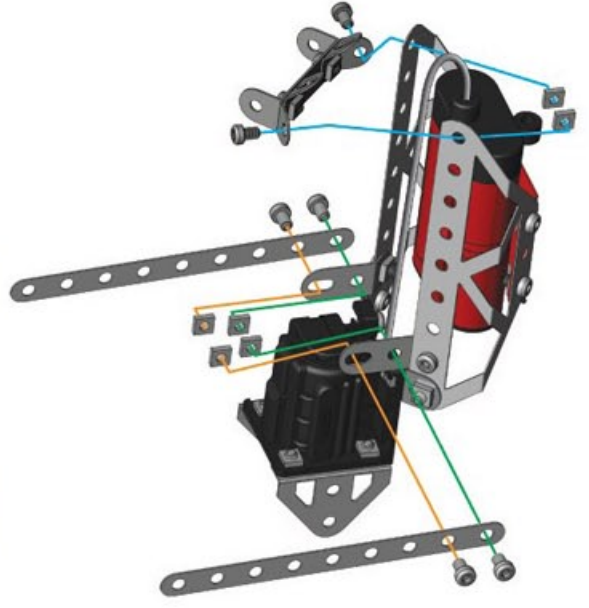

4

-  x1
-  x4
-  x2
-  x2







3 + 4 +

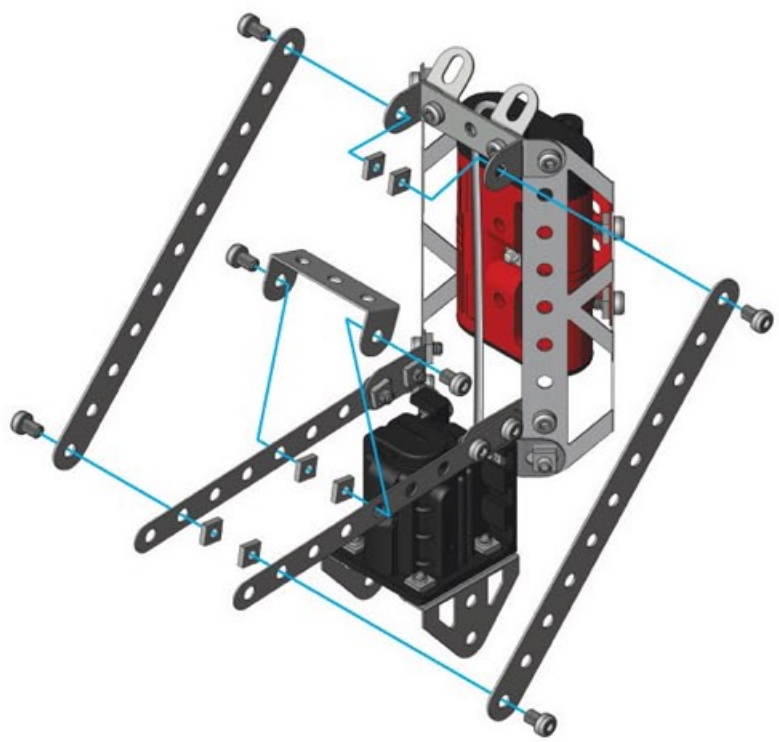





5

-  x2
-  x6
-  x6



6

-  x2
-  x1
-  x6
-  x6

- 7
-  x2
 -  x1
 -  x1
 -  x2
 -  x1
 -  x7
 -  x7

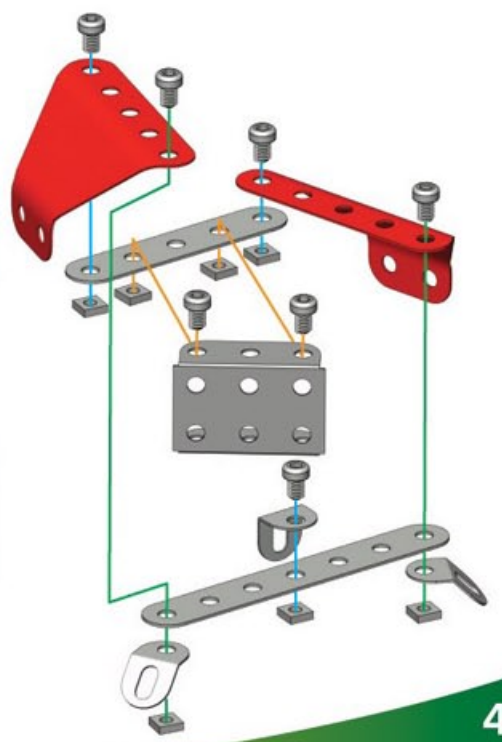

8

	x2		x1
	x1		x2
	x1		x3
	x1		x3
			x2

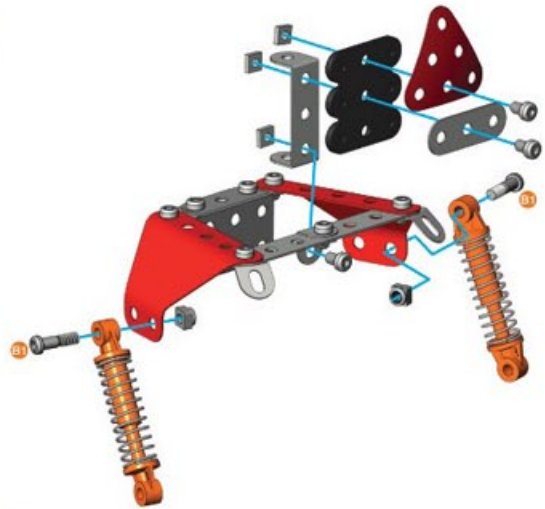

9

	x1
	x1
	x1
	x2
	x1
	x2
	x5
	x4
	x2
	x1

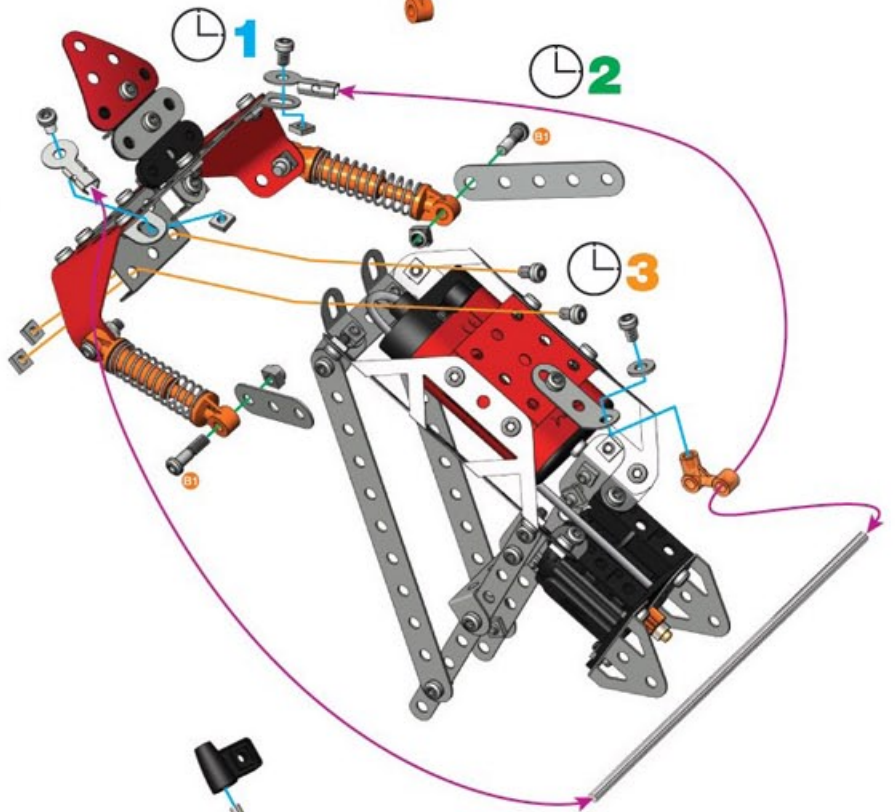

10

	x1
	x2
	x1
	x1
	x2
	x1
	x5
	x6

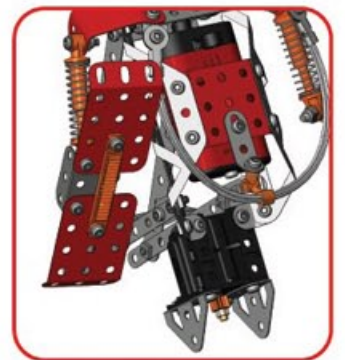
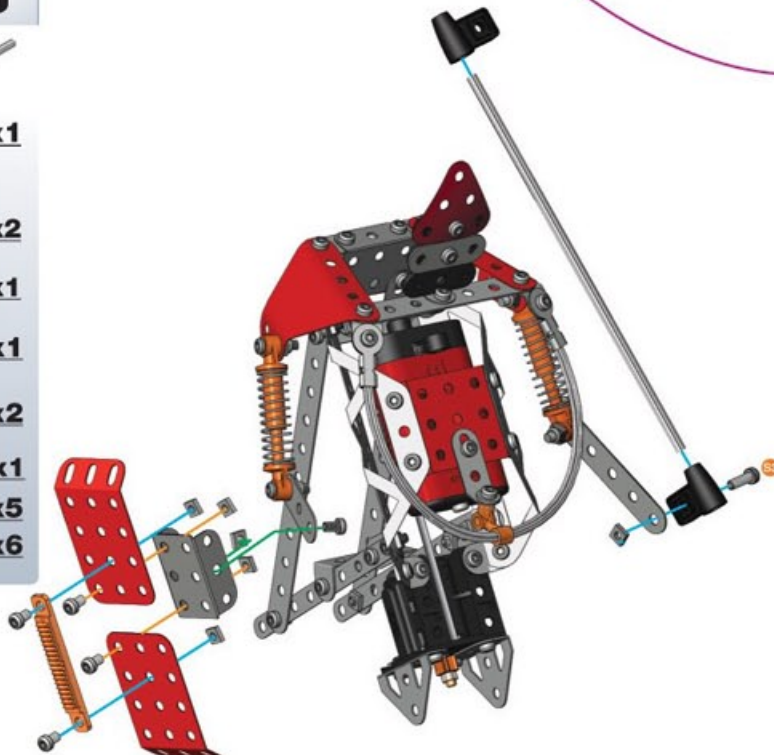

11

-  **x2**
-  **x1**
-  **x1**
-  **x2**
-  **x1**
-  **x1**
-  **x2**
-  **x3**
-  **x1**
-  **x4**

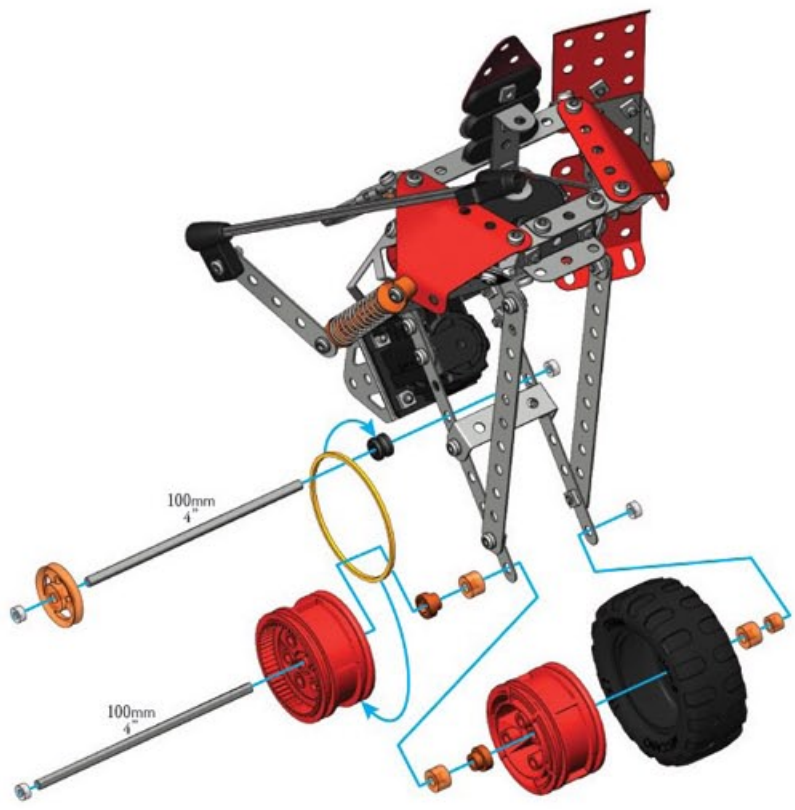

12

-  **x1**
-  **x1**
-  **x2**
-  **x2**
-  **x1**
-  **x1**
-  **x4**
-  **x2**
-  **x2**
-  **x1**















1

-  x1
-  x2
-  x1
-  x1
-  x4
-  x4







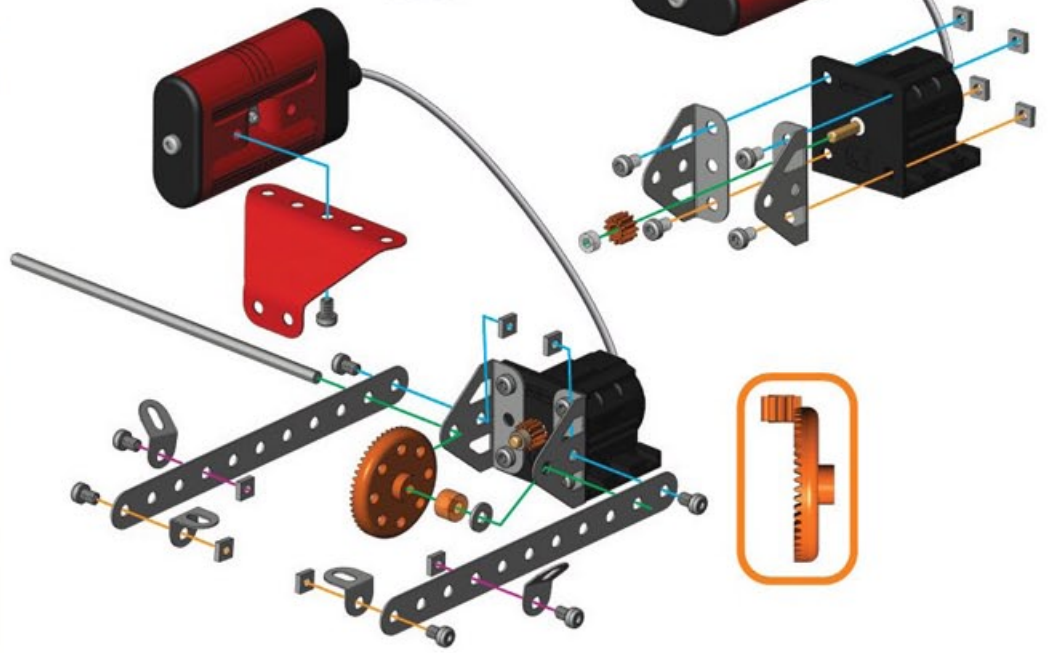



2

-  x2
-  x1
-  x1
-  x1
-  x1
-  x2
-  x2
-  x7
-  x6
-  x1

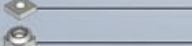
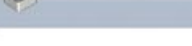

3

-  x1
-  x1
-  x2
-  x2
-  x2
-  x4
-  x2
-  x2
-  x4
-  x4

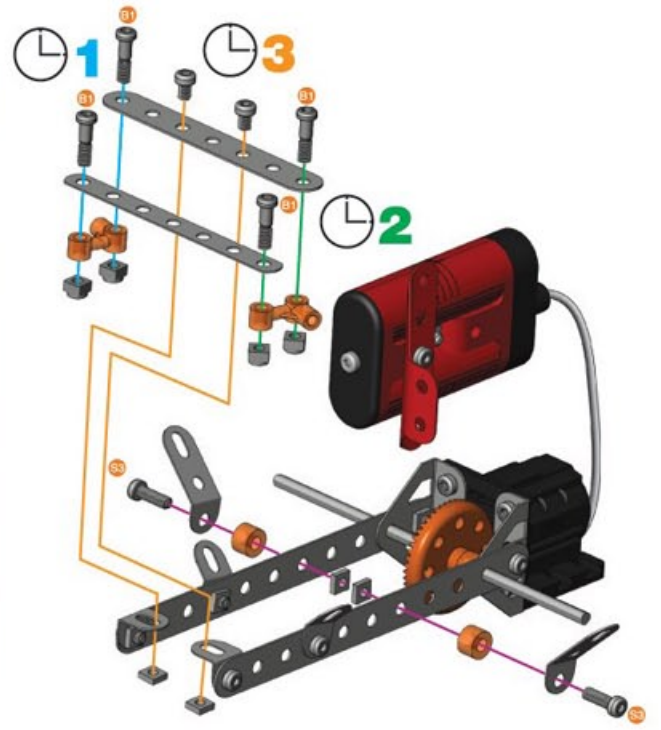

4

	x2
	x1
	x1
	x2
	x2
	x2
	x1
	x2

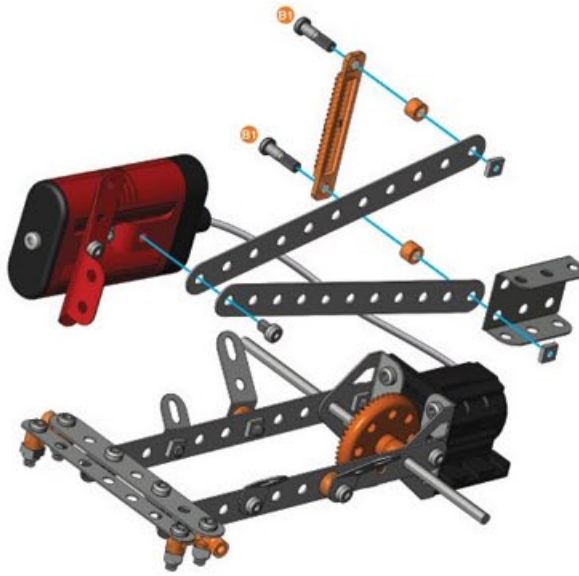
**5**

	x2
	x2
	x1
	x1
	x2
	x2
	x4
	x8

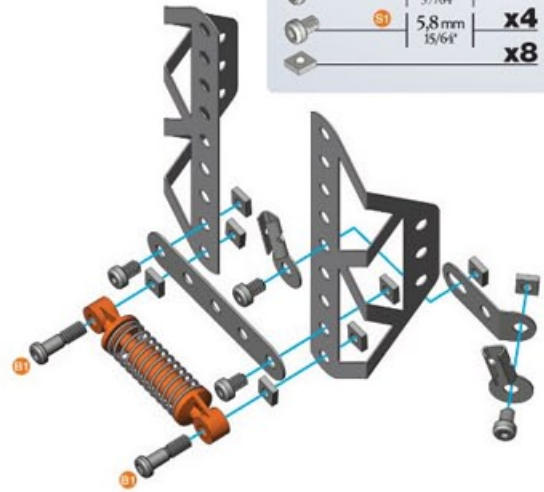
**4 + 5 +****6**



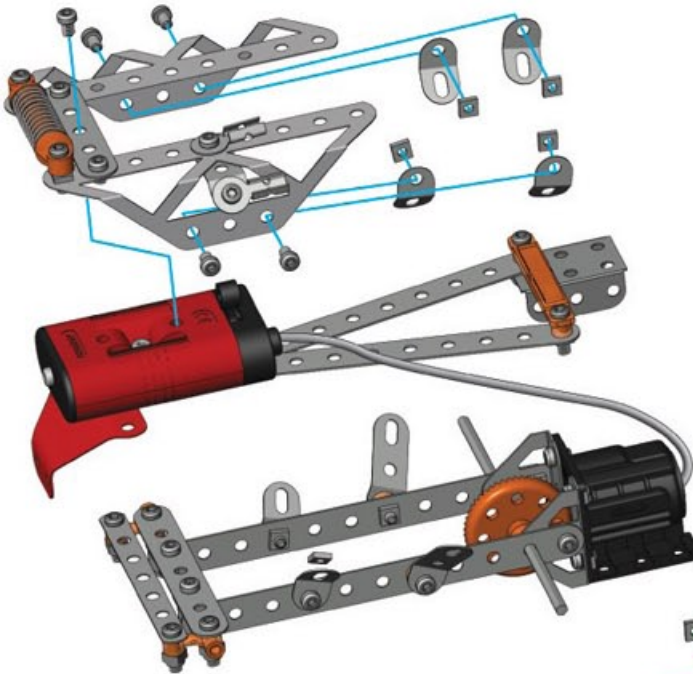



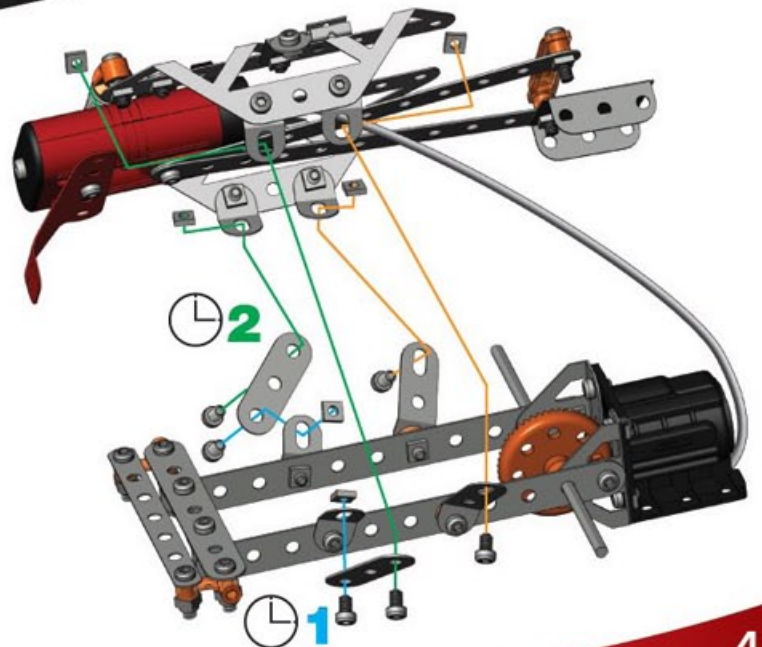

	x4
	x5
	x4

**4 + 5 +****7**

	x2
	x6
	x6







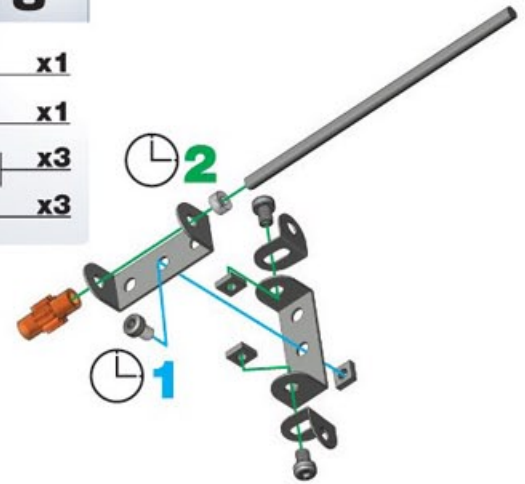

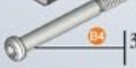

8

-  100 mm | $\frac{1}{4}$ " | **x1**
-  **x1**
-  **x2**
-  **x1**
-  **x2**
-  **x2**
-  **x3**
-  **x3**







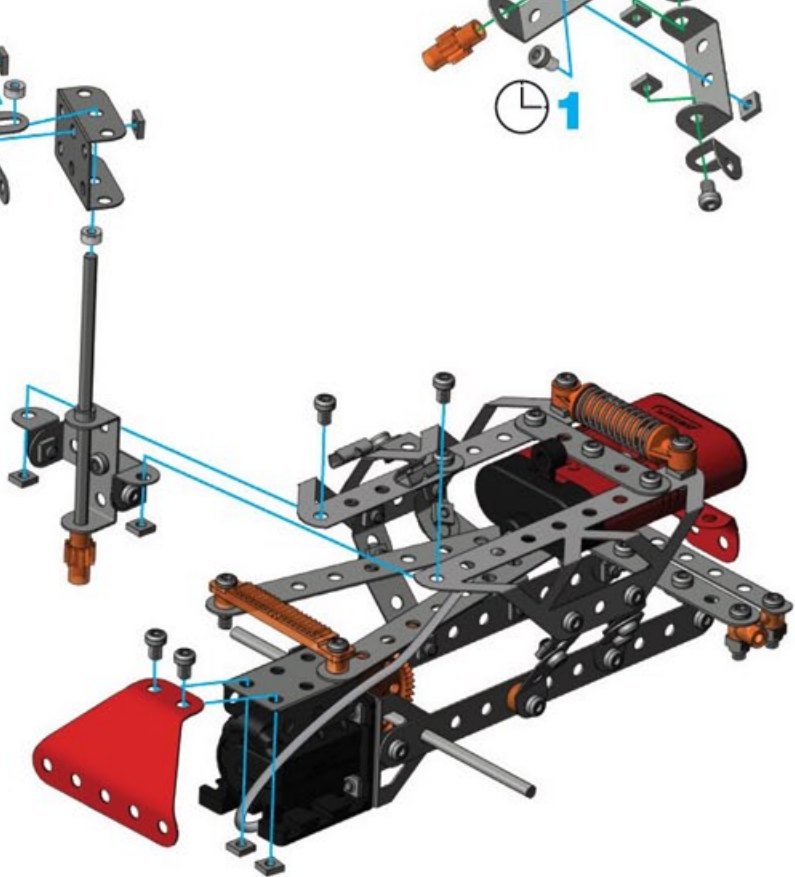

9

-  **x1**
-  **x1**
-  **x1**
-  38,1 mm | $\frac{1}{2}$ " | **x1**
-  **x2**
-  **x2**
-  5,8 mm | $\frac{15}{64}$ " | **x6**
-  **x8**
-  **x1**







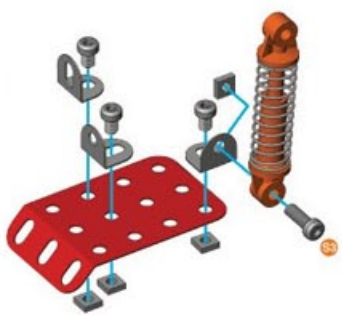



10

-  **x1**
-  **x3**
-  12 mm | $\frac{1}{2}$ " | **x1**
-  5,8 mm | $\frac{15}{64}$ " | **x3**
-  **x4**
-  **x1**



11

-  **x1**
-  **x1**
-  **x1**
-  **x1**
-  **x2**
-  **x1**
-  5,8 mm | $\frac{15}{64}$ " | **x5**
-  **x5**

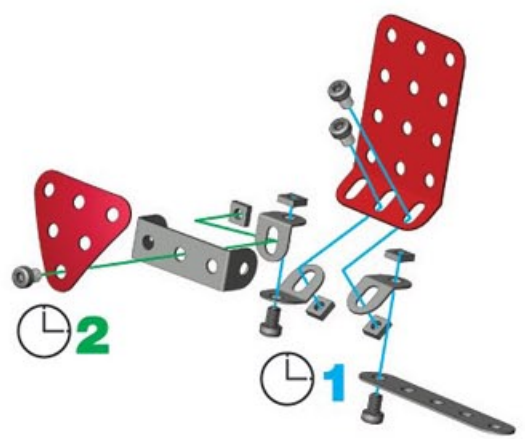

9+10+

12

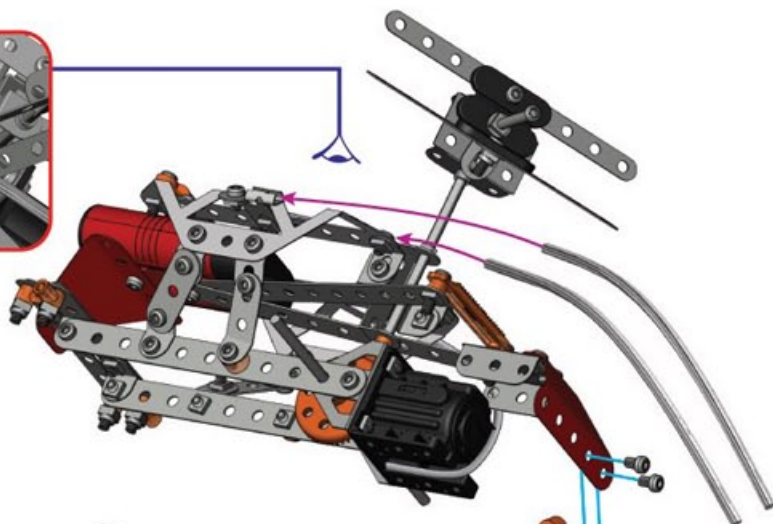
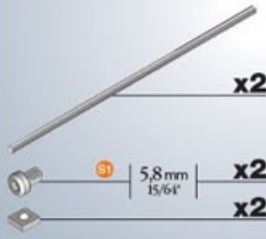

11+

13

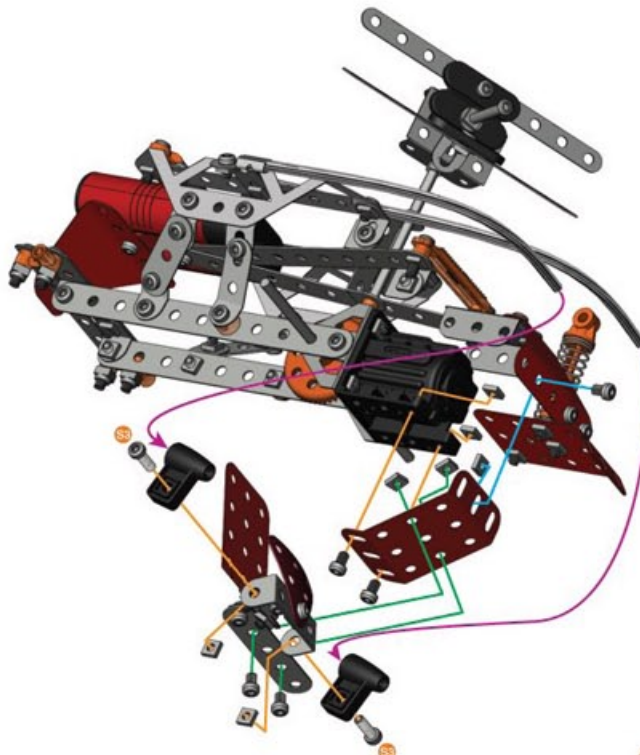

14

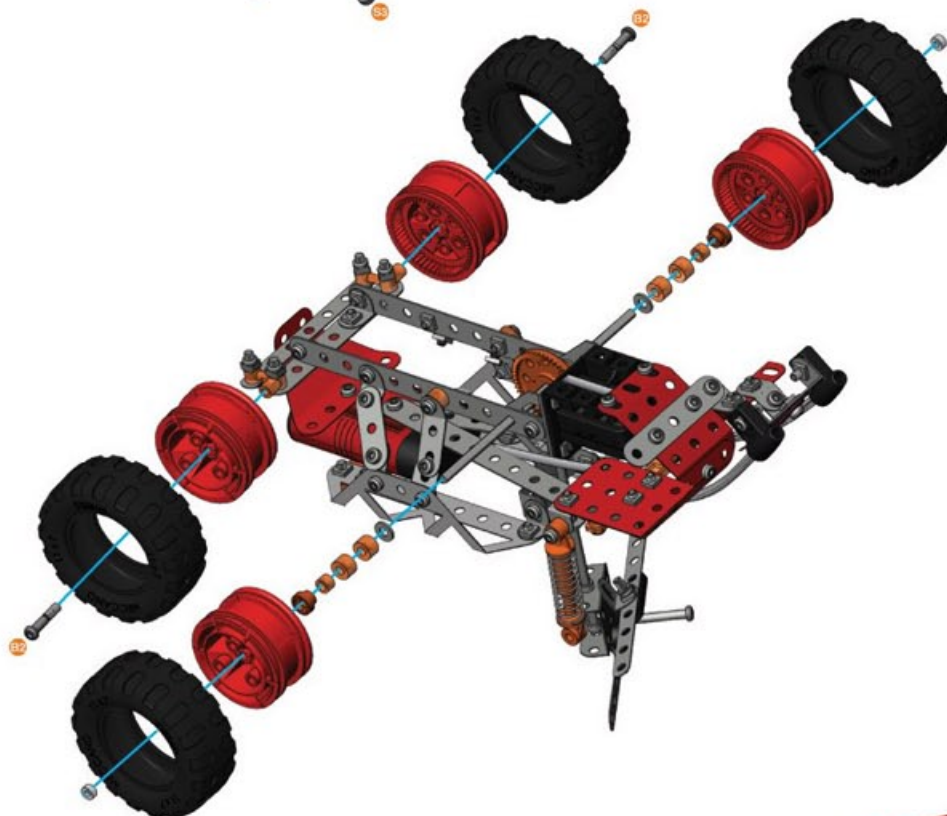

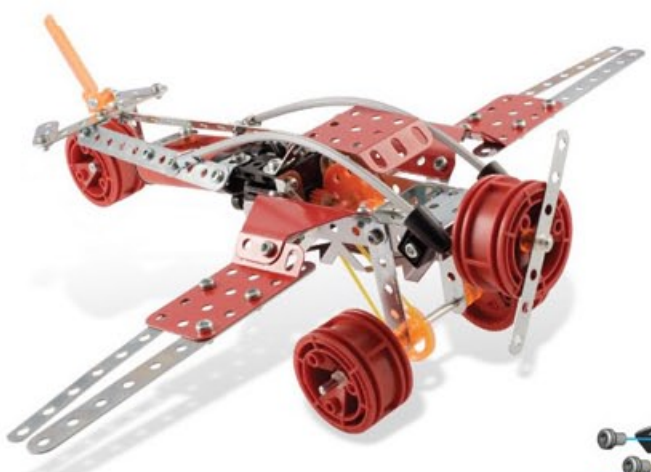

1

- x1
- x2
- x1
- x1
- x1
- x2
- x1
- 12mm 1/2" x1
- 5,8mm 15/64" x6
- x6

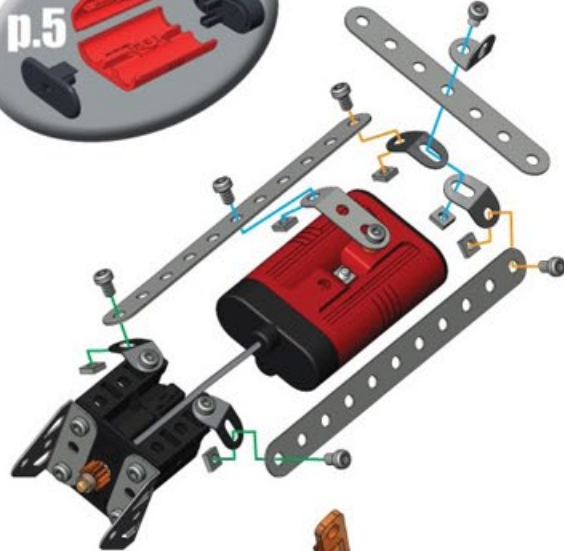
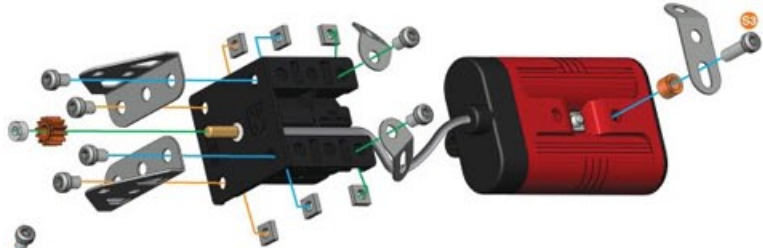

2

- x1
- x2
- x1
- 5,8mm 15/64" x6
- x6

4

- x2
- x4
- 5,8mm 15/64" x4
- x4

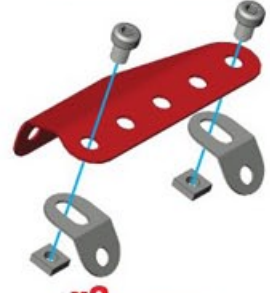





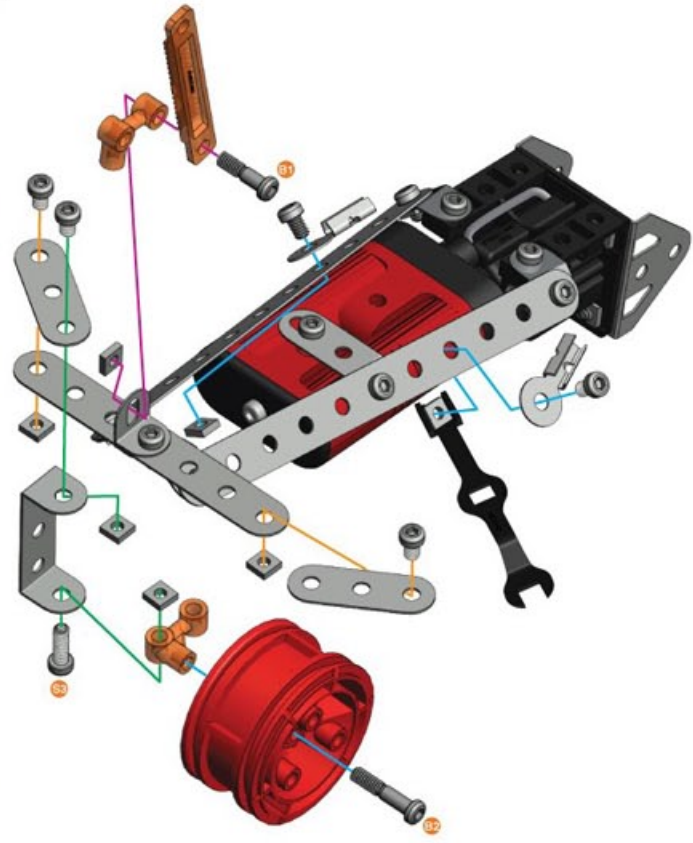



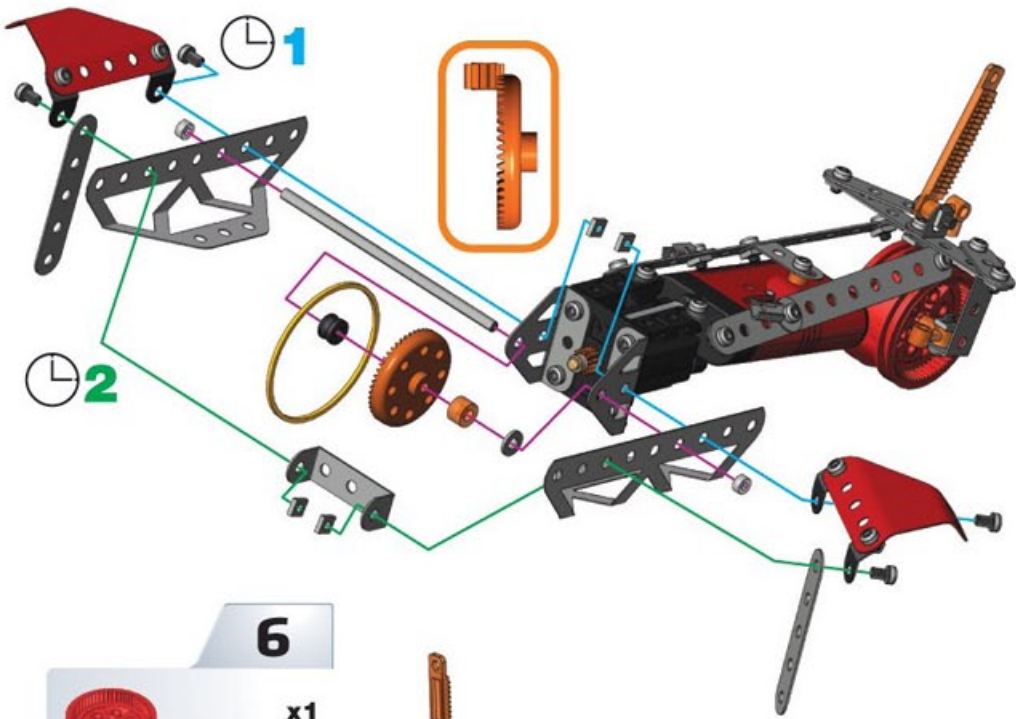

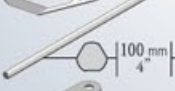

3

- x1
- x1
- x1
- x2
- x2
- x2
- 19mm 3/4" x1
- 14,7mm 37/64" x1
- 12mm 1/2" x1
- 5,8mm 15/64" x5
- x7



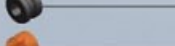
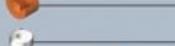







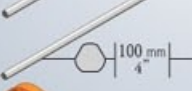

5



-  x2
-  x1
-  x2
-  x1
-  x1
-  x1
-  x1
-  x1
-  x2
-  x4
-  x4
-  x1



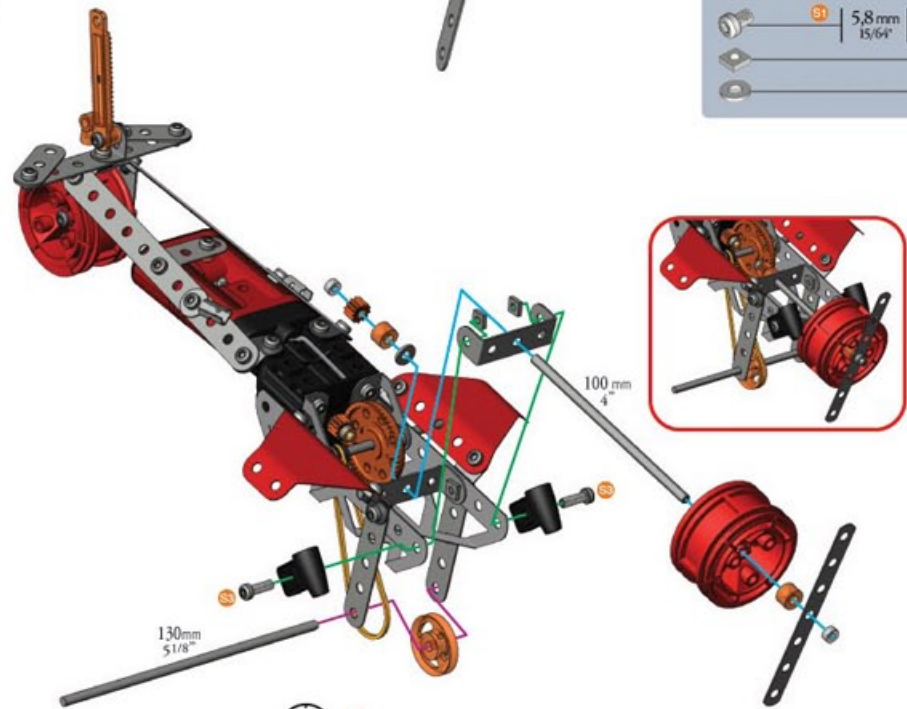

6

-  x1
-  x1
-  x1
-  x1
-  x1
-  x1
-  x2
-  x1
-  x2
-  x2
-  x2
-  x1



1

7

-  x2
-  x1
-  x2
-  x4
-  x4

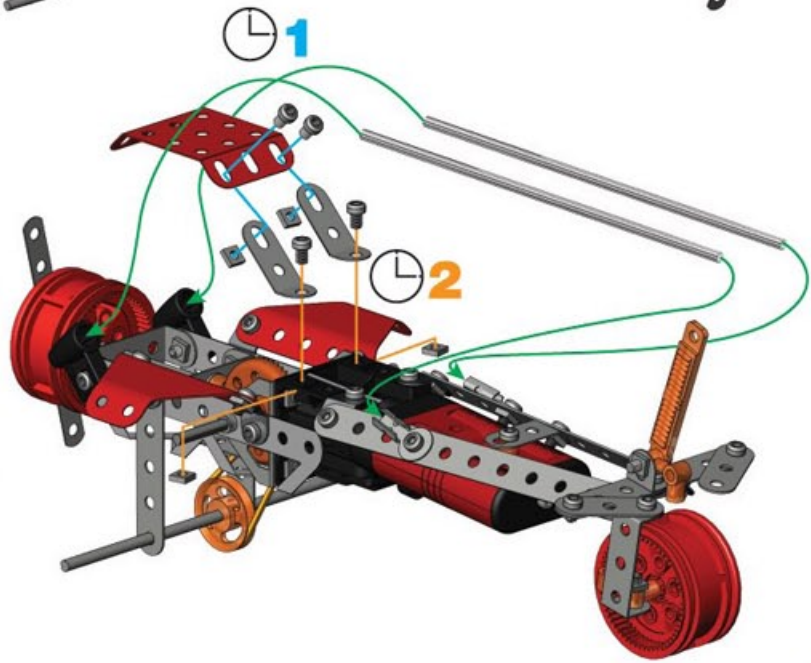



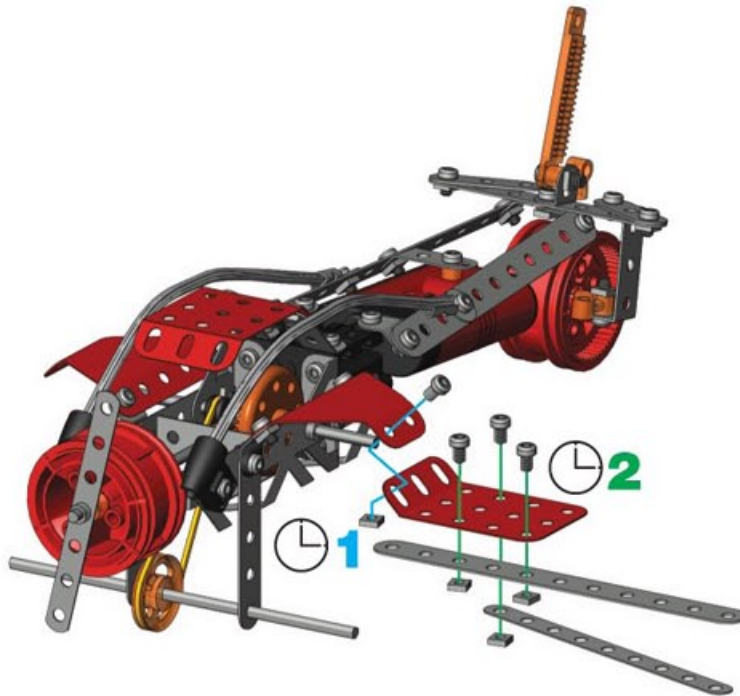
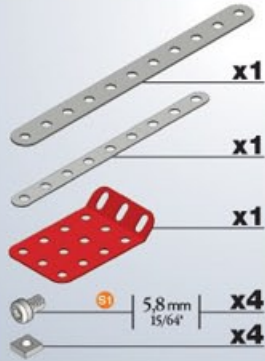
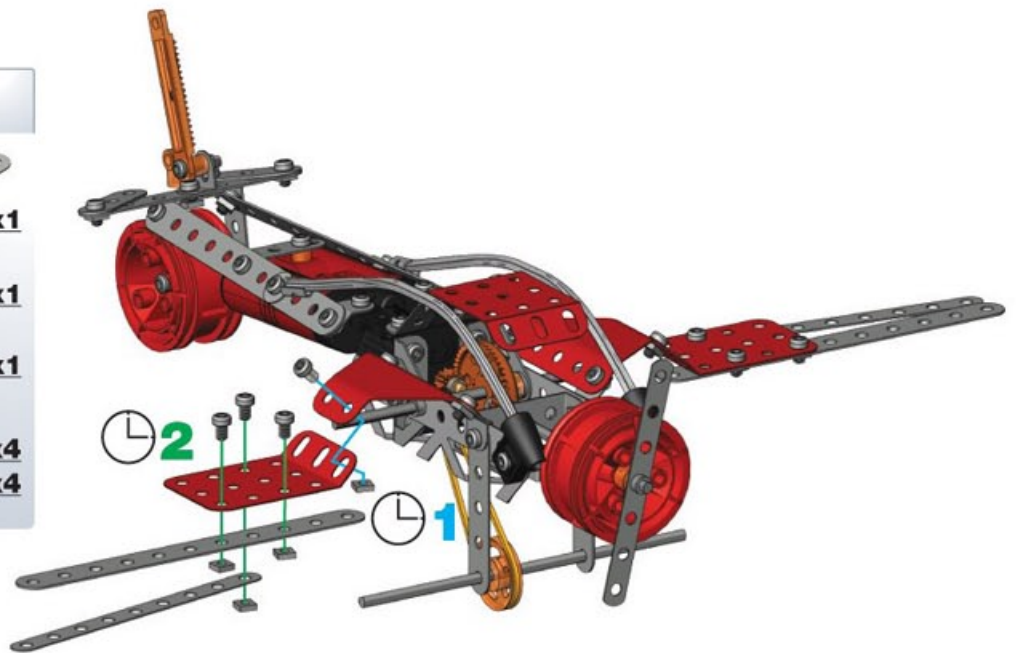
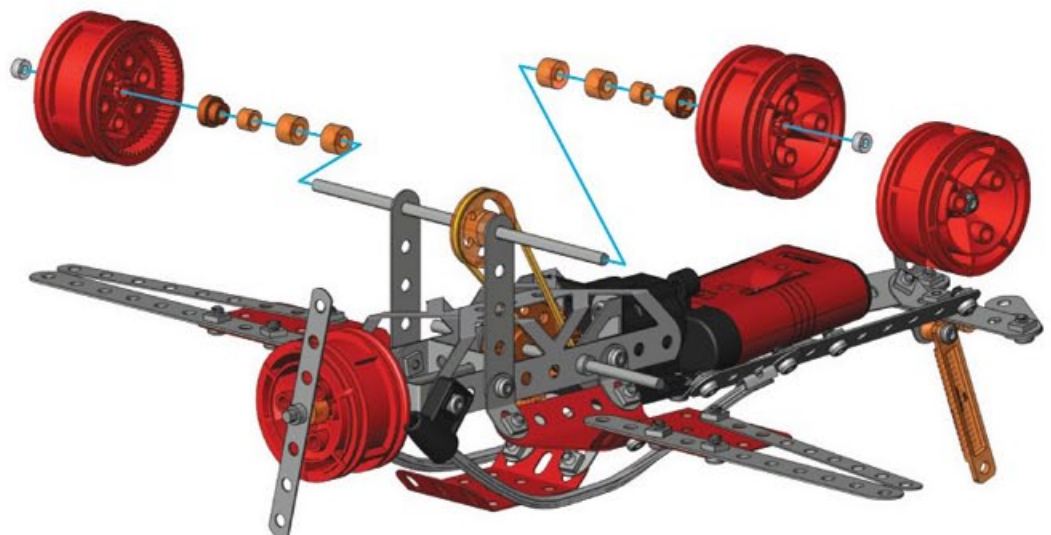

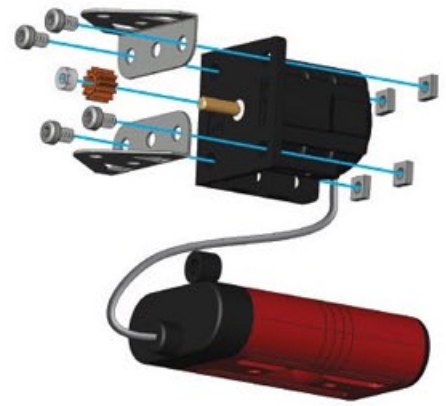

2

8**9****10**

1

-  **x1**
-  **x2**
-  **x1**
-  **x1**
-  **x4** | 5,8mm | 15/64"
-  **x4**





**p.5****2**

-  **x2**
-  **x1**
-  **x2**
-  **x4** | 5,8mm | 15/64"
-  **x2**

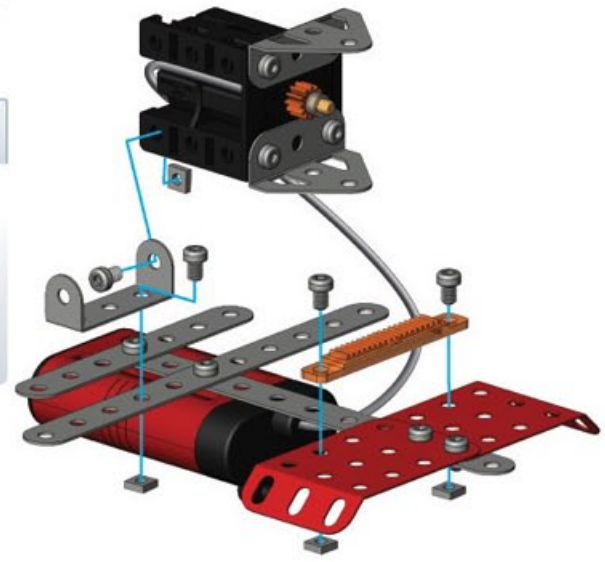
**3**

-  **x1**
-  **x1**
-  **x4** | 5,8mm | 15/64"
-  **x4**

**4**

-  **x1**
-  **x2**
-  **x6** | 5,8mm | 15/64"
-  **x6**

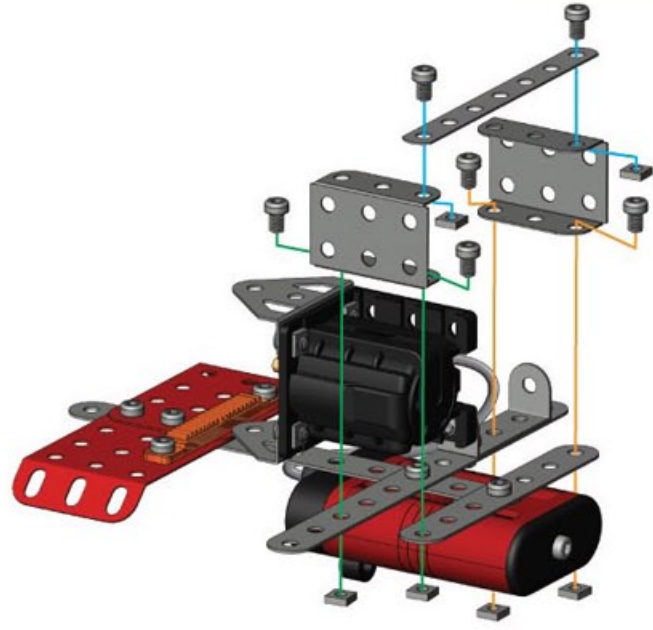



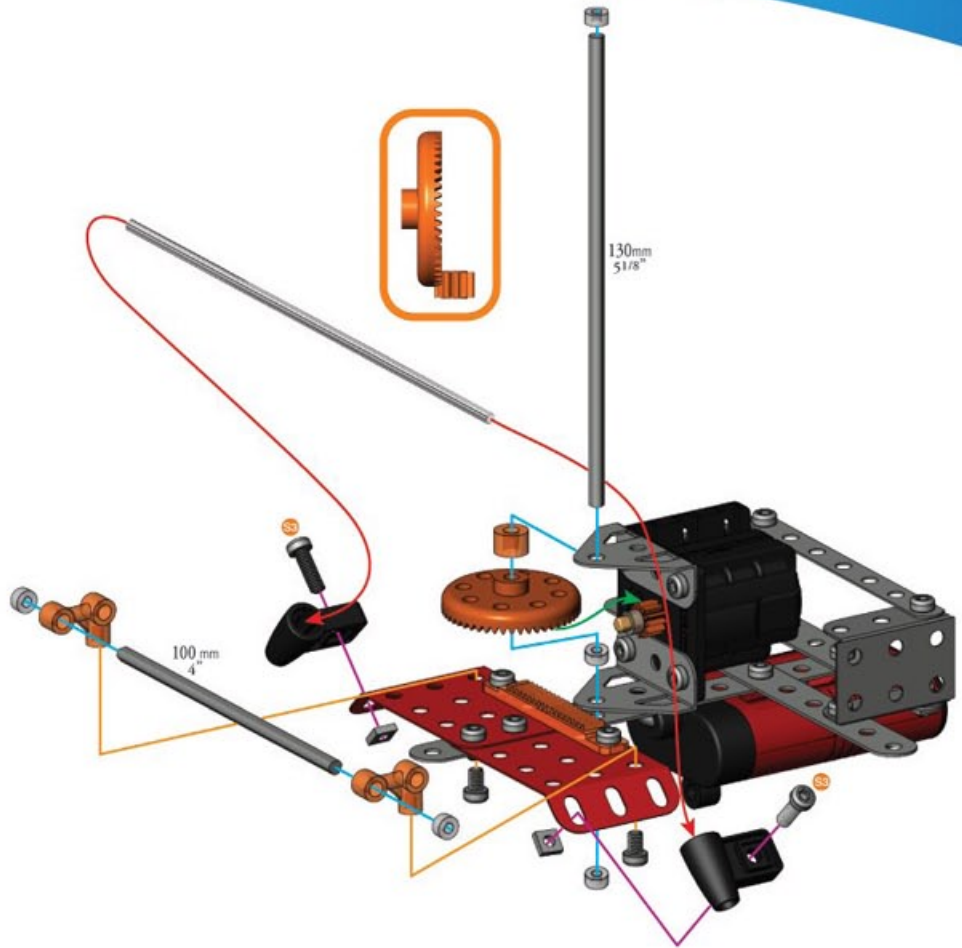

5

-  **x1**
-  **x1**
130mm
5 1/8"
-  **x1**
100mm
4"
-  **x2**
-  **x2**
-  **x1**
-  **x1**
-  **x5**
-  **x2**
12mm
1/2"
-  **x2**
5.8mm
15/64"
-  **x2**



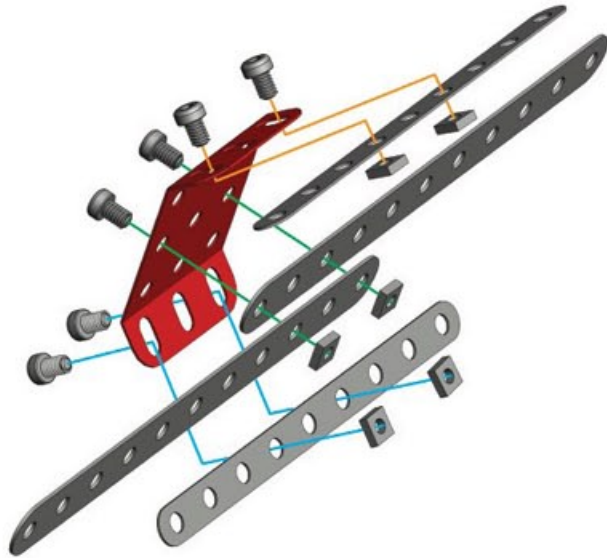

6

-  **x2**
-  **x2**
-  **x1**
-  **x6**
5.8mm
15/64"
-  **x6**







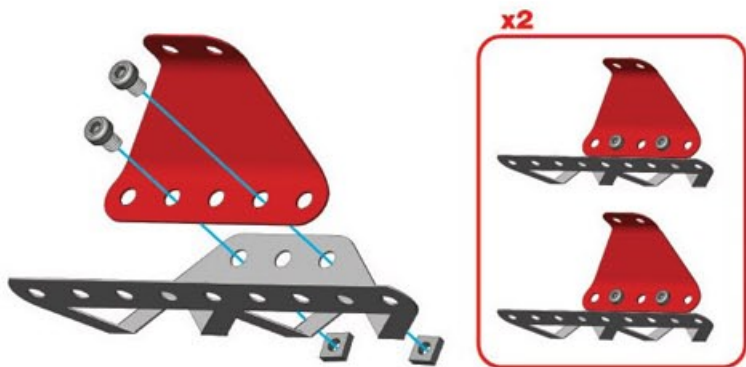

7

-  **x2**
-  **x4**
5.8mm
15/64"
-  **x4**



⑥+⑦+



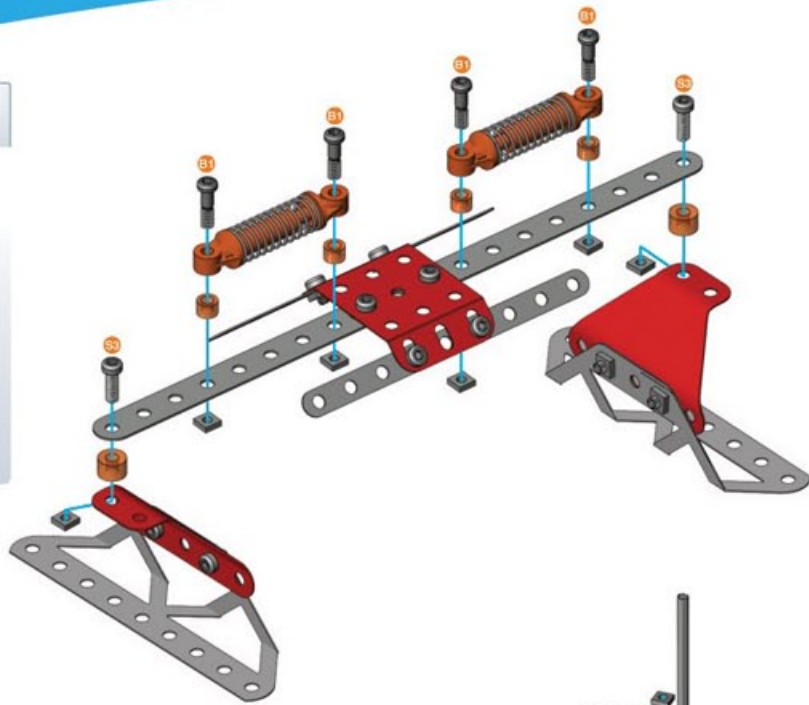

8

-  x2
-  x2
-  x4
-  $14,7\text{mm}$ $37/64$ x4
-  12mm $1/2$ x2
-  x6



⑤+

9

-  x3
-  x3
-  x3
-  $14,7\text{mm}$ $37/64$ x3
-  x3

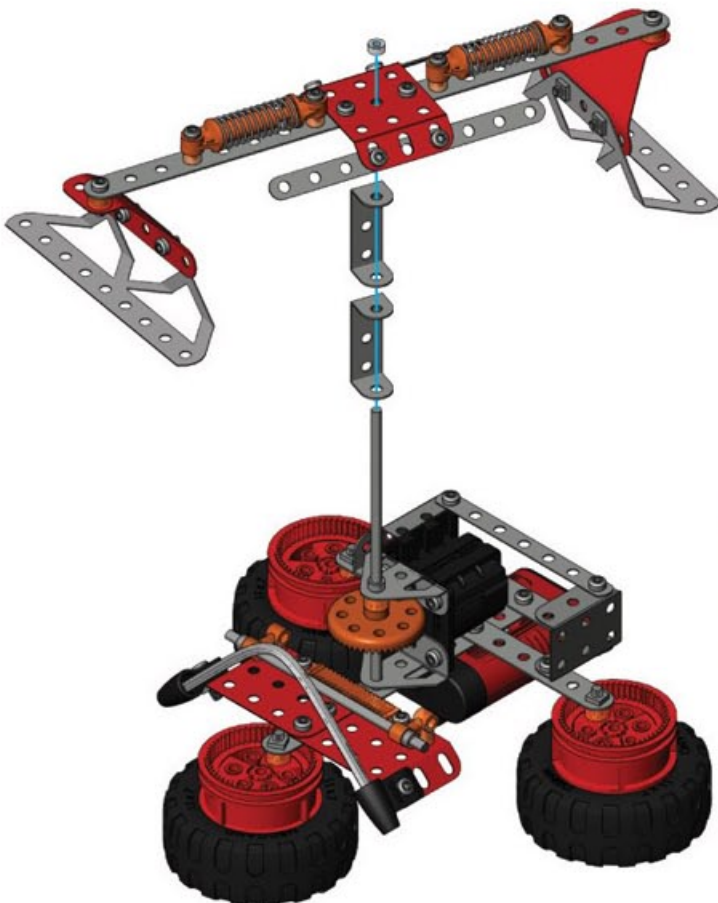
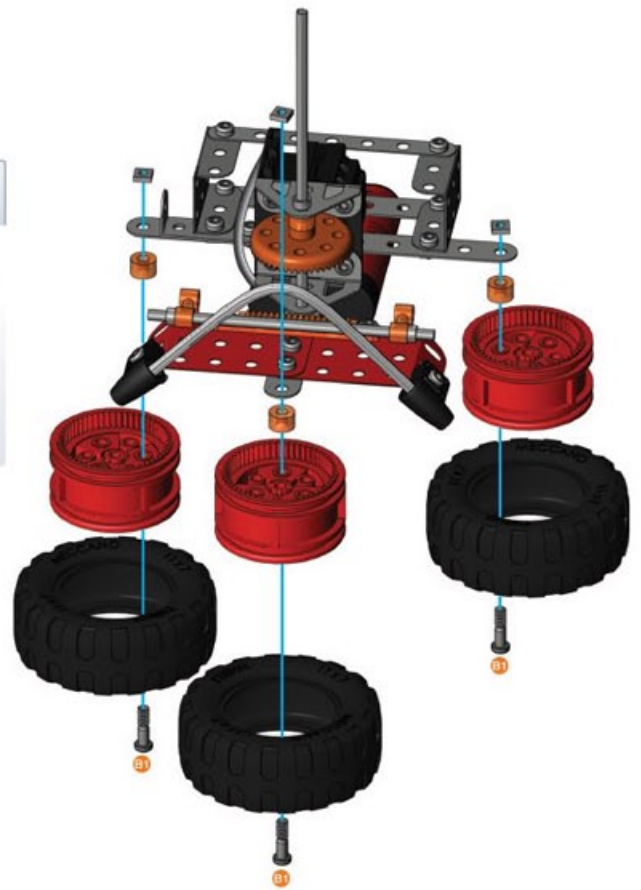

⑧+⑨+

10

-  x2
-  x1







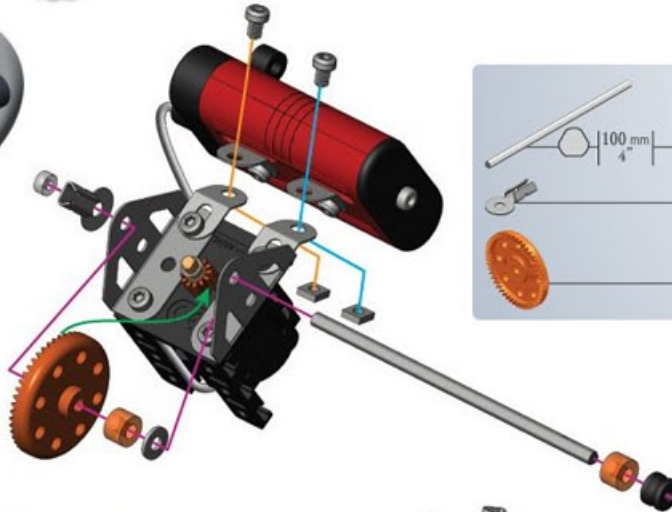



1

-  x1
-  x2
-  x4
-  x1
-  x1
-  5,8mm 15/64" x6
-  x4



2







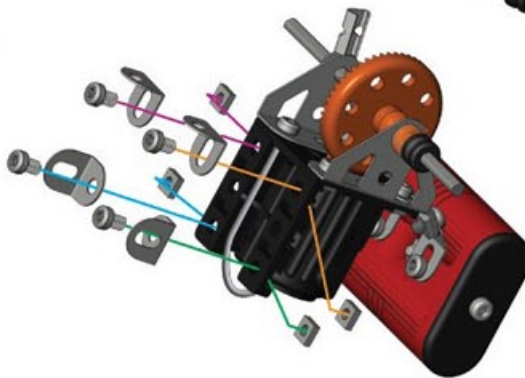

-  x2
-  100mm 4" x1
-  x1
-  x1
-  5,8mm 15/64" x2
-  x1
-  x2
-  x1

3

-  x4
-  5,8mm 15/64" x4
-  x4



4

-  x2
-  x1
-  x1
-  x1
-  x1
-  x1
-  12mm 1/2" x1
-  5,8mm 15/64" x5
-  x6



5

-  5,8mm 15/64" x4
-  x4

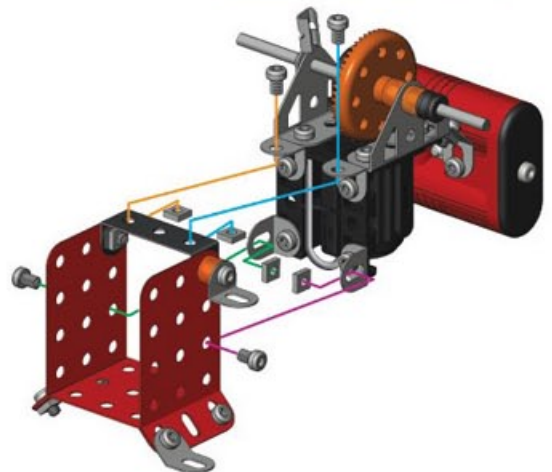

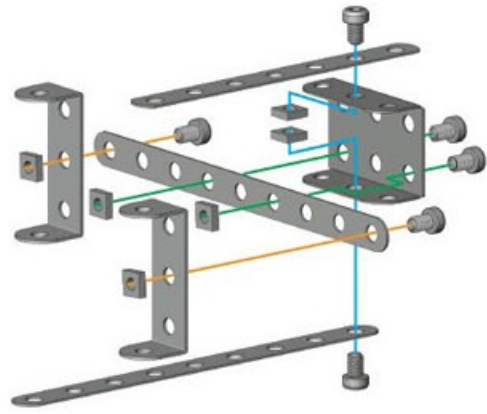
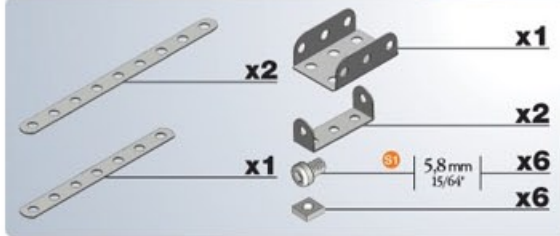
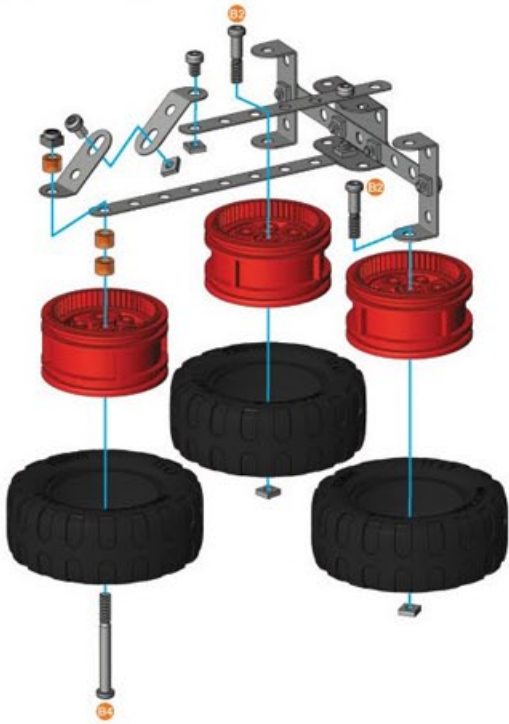
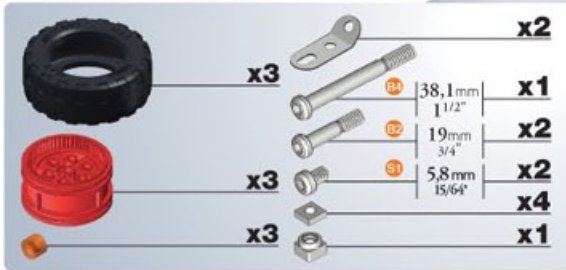
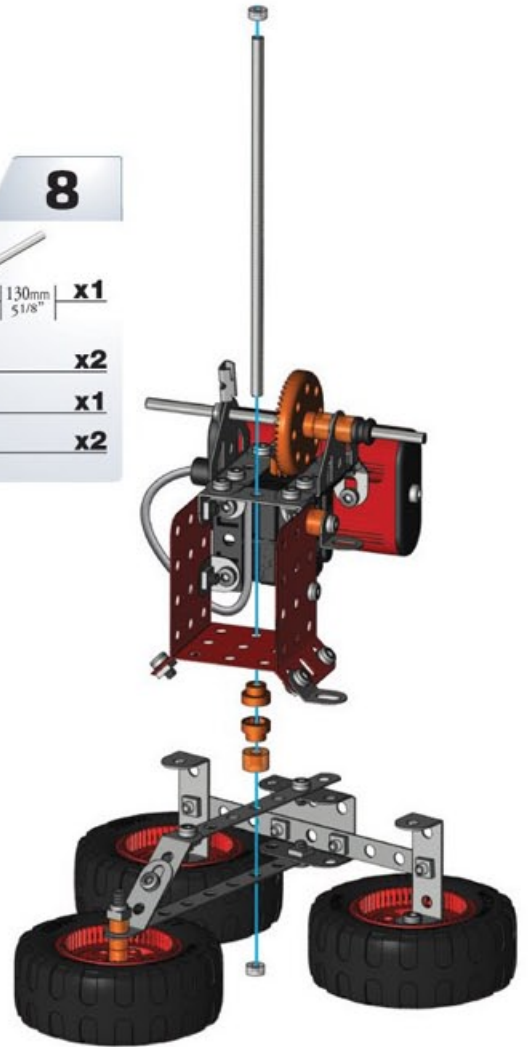
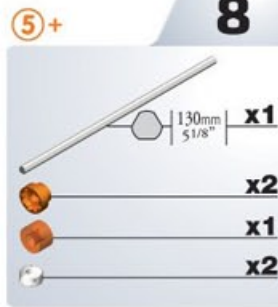
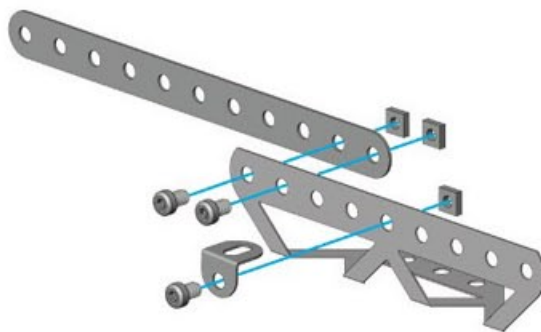
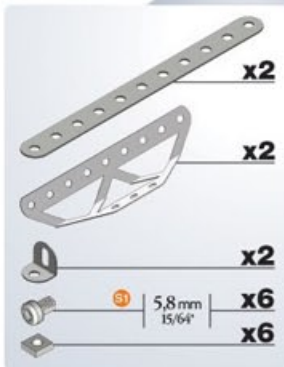
6**7****8****9****x2**

10

	x2		x1
	x1		x1
	x1		x1
	x1		x6
	x6		x6
	x1		x1

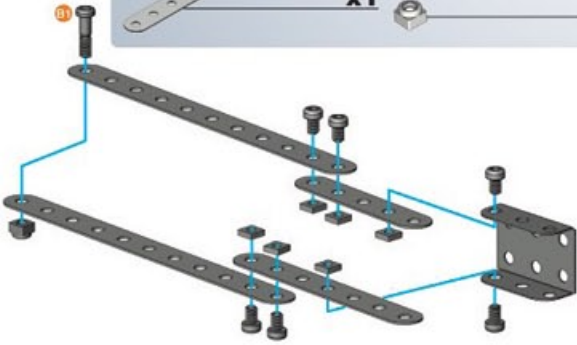

9 + 10 +

11

	x4		x4
--	----	--	----

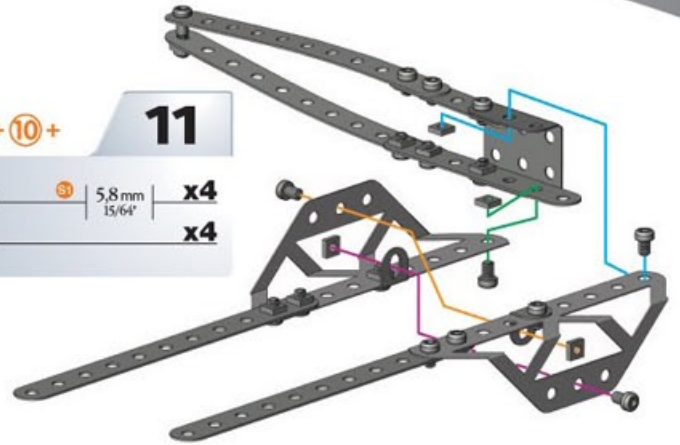

8 + 11 +

12

	x1		x1
	x2		x2
	x1		x1
	x4		x1

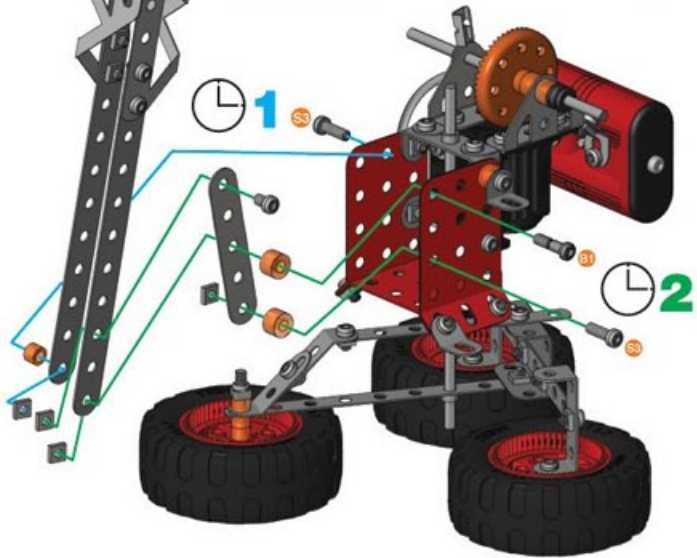

13

	x2		x3
	x3		x3

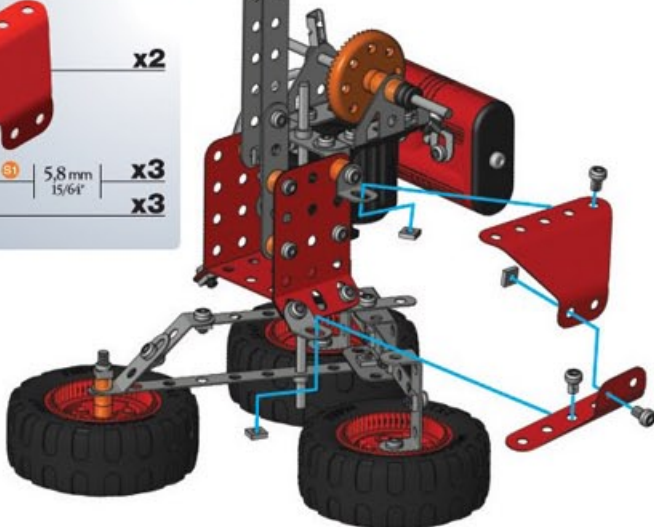













14

	x1		x1
	x1		x1
	x1		x1
	x1		x1



13 + 14 +





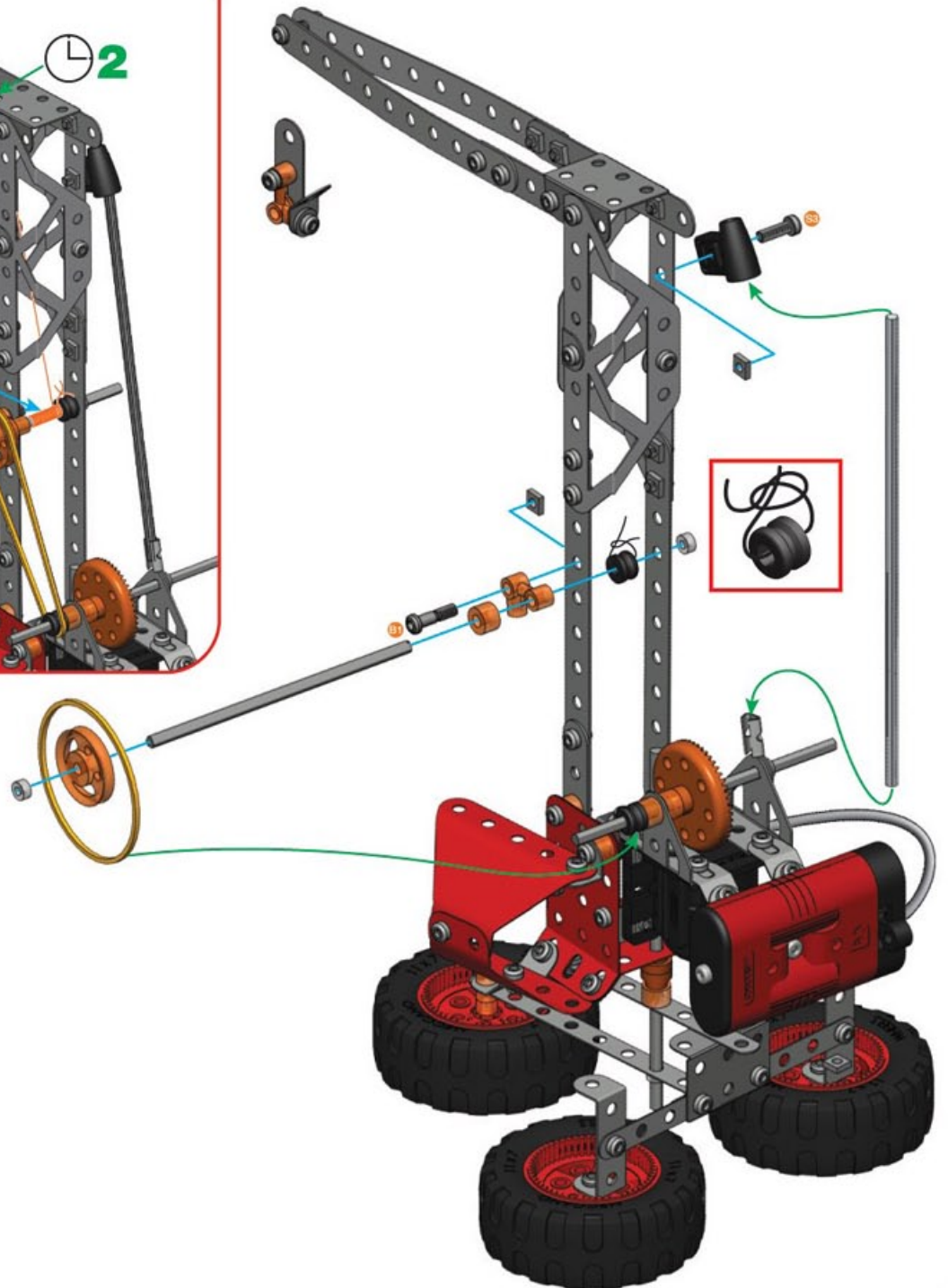
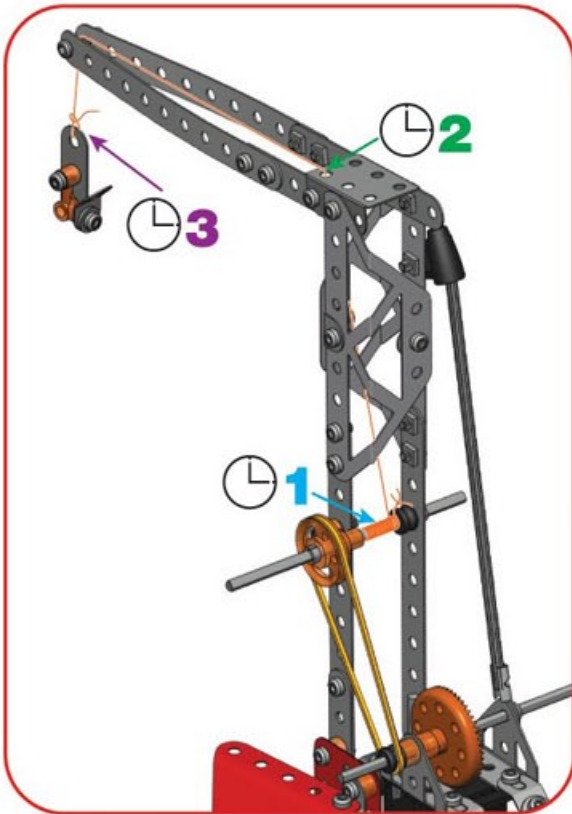



15

	x1
	x1
	x1
	x1
	x1
	x1
	x1
	x1
	x1
	14,7mm 37/64" x1
	12mm 1/2" x1
	x2





1

-  x1
-  x1
-  x2
-  x1
-  x1
-  x1
-  5,8 mm | 15/64" x6
-  x4

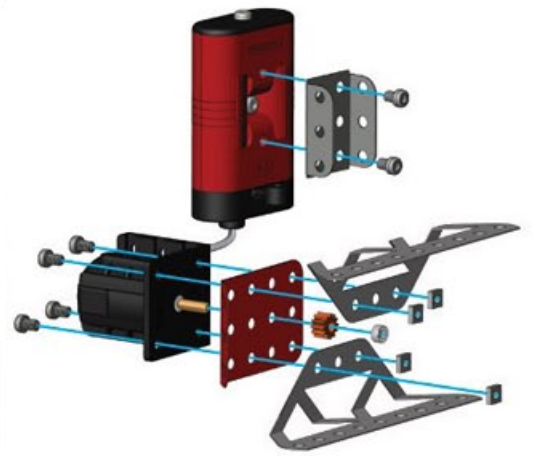



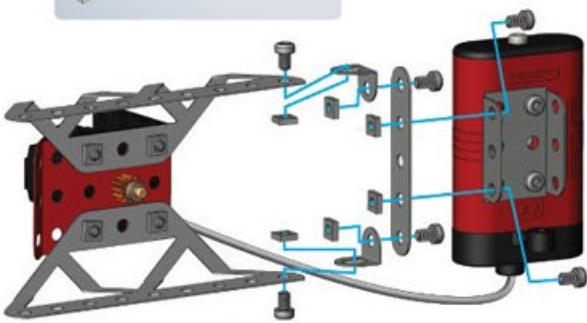

2

-  x1
-  x2
-  5,8 mm | 15/64" x6
-  x6





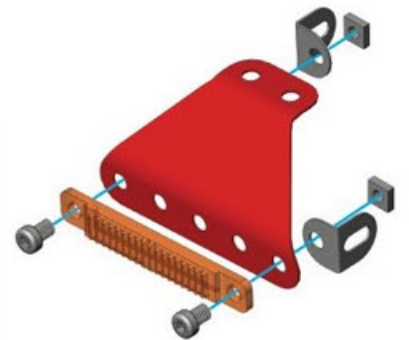

3

-  x1
-  x1
-  x2
-  5,8 mm | 15/64" x2
-  x2



②+③+

4

-  x1
-  x1
-  5,8 mm | 15/64" x6
-  x6

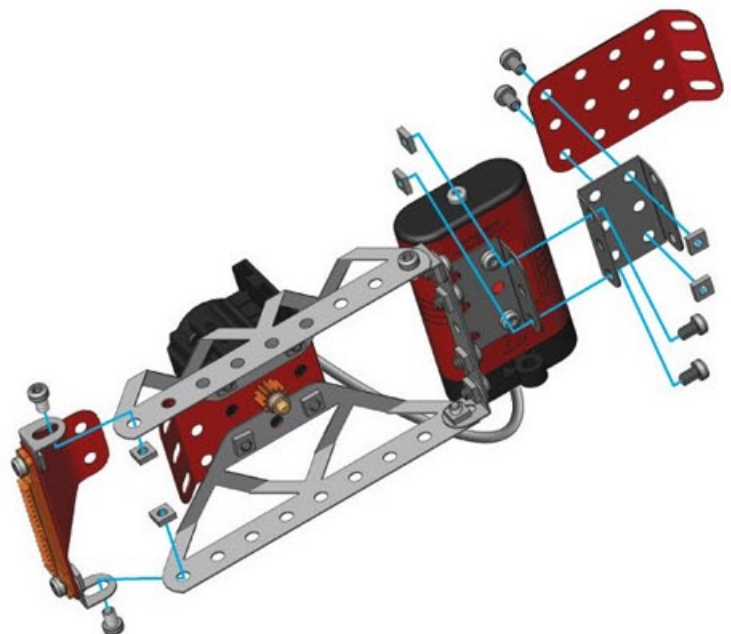

5

- x1
- x2
- 5.8mm | 15/64" x4
- x4

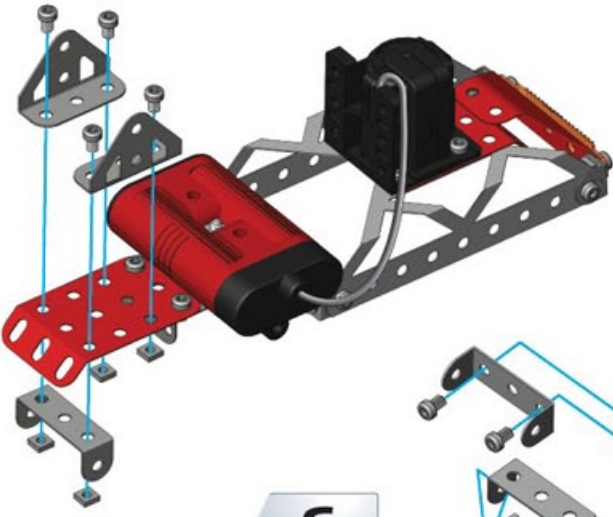

6

- x2
- x2
- 5.8mm | 15/64" x4
- x4

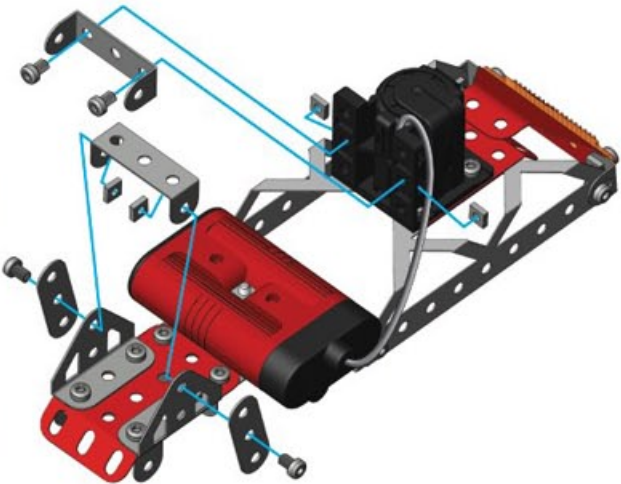

7

- x2
- x2
- x4
- 14.7mm | 37/64" x4
- x4

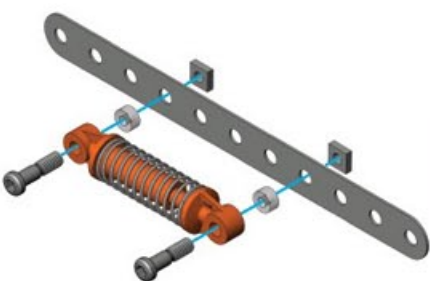

(6) + (7) + **8**

- 5.8mm | 15/64" x4
- x4

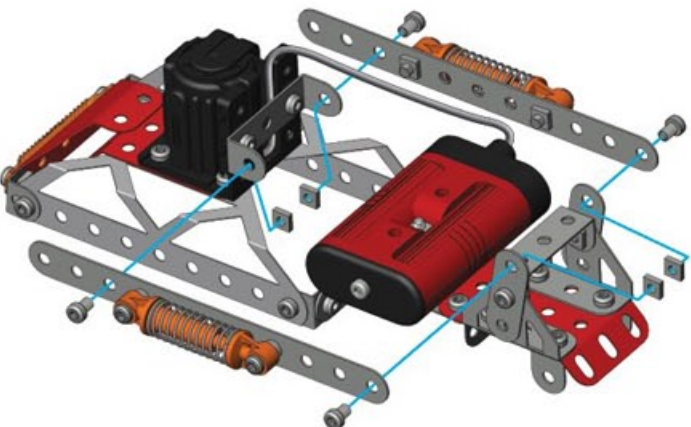



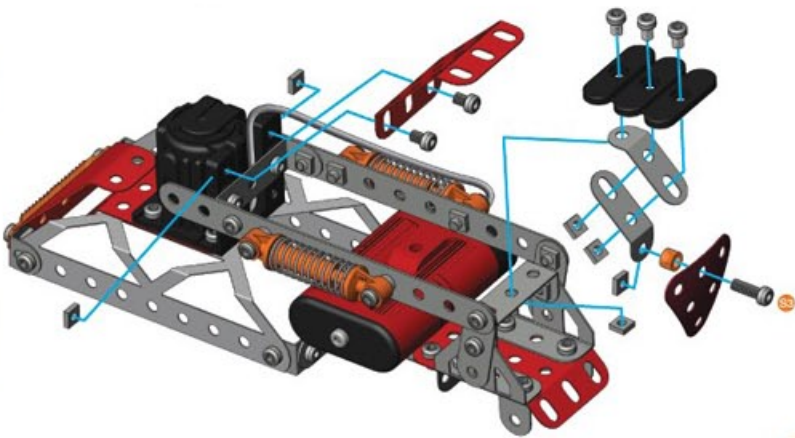

9

- x1
- x1
- x1
- x2
- 12mm | 1/2" x1
- 5.8mm | 15/64" x5
- x6



10

-  x1
-  x2
-  x2
-  5,8 mm | 15/64" x4
-  x4









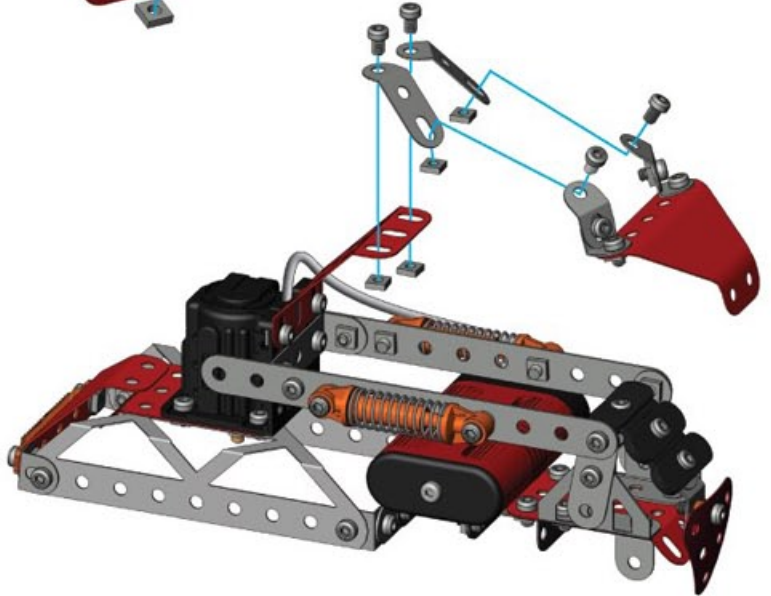

9 + 10 +

11

-  x2
-  5,8 mm | 15/64" x4
-  x4



12

-  x4
-  x4
-  130mm | 5 1/8" x1
-  100mm | 4" x1
-  x1
-  x2
-  x9
-  x4
-  x1

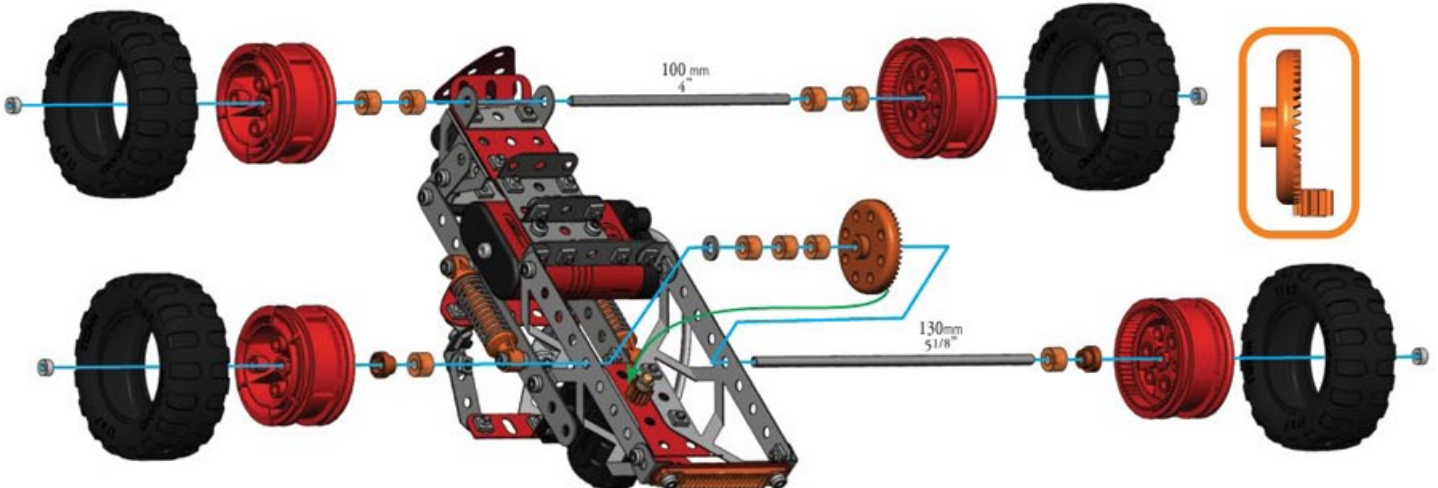



1

- x2
- x1
- x1
- x2
- x1
- x1
- x6
- x4

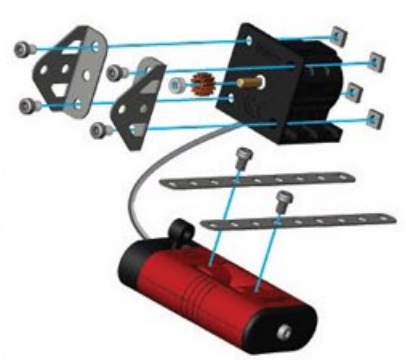

2

- x2
- x2
- x6
- x6



3

- x1
- x1
- x2
- x2



4

- x2
- x1
- x1
- x6
- x6

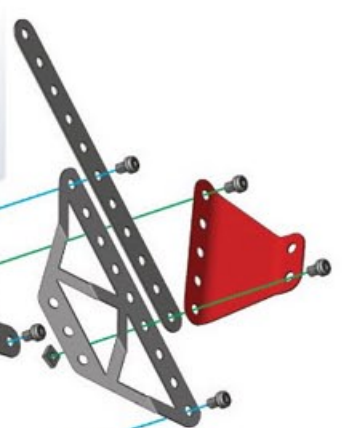

5



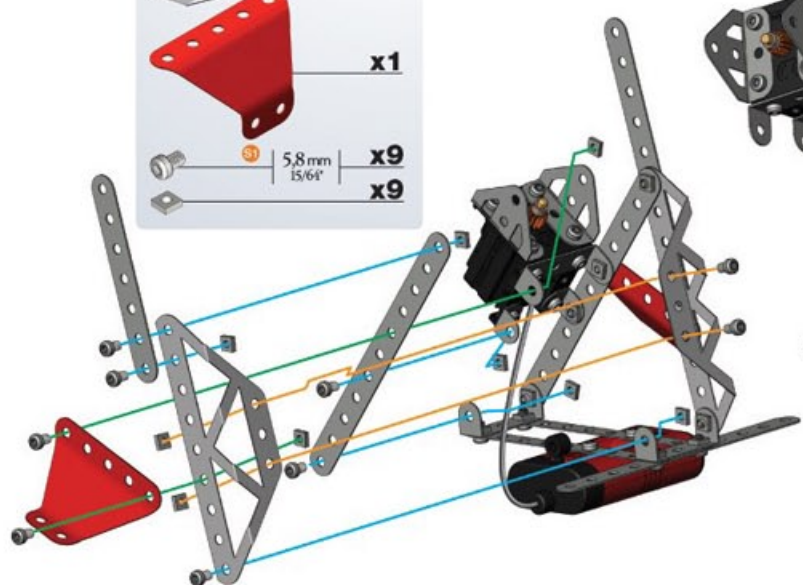



- x1
- x1
- x1
- x1
- x9
- x9

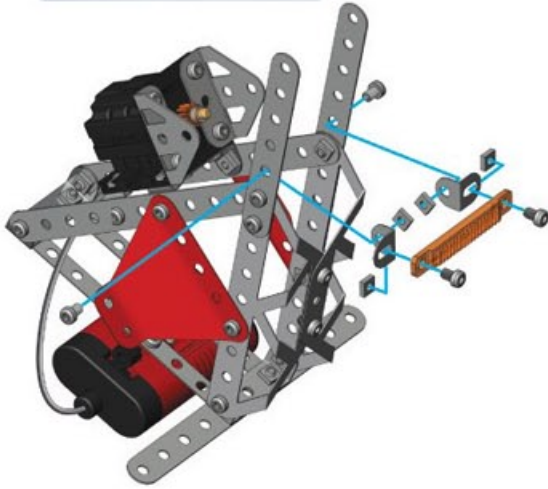







6

	x1
	x2
	x4
	x4





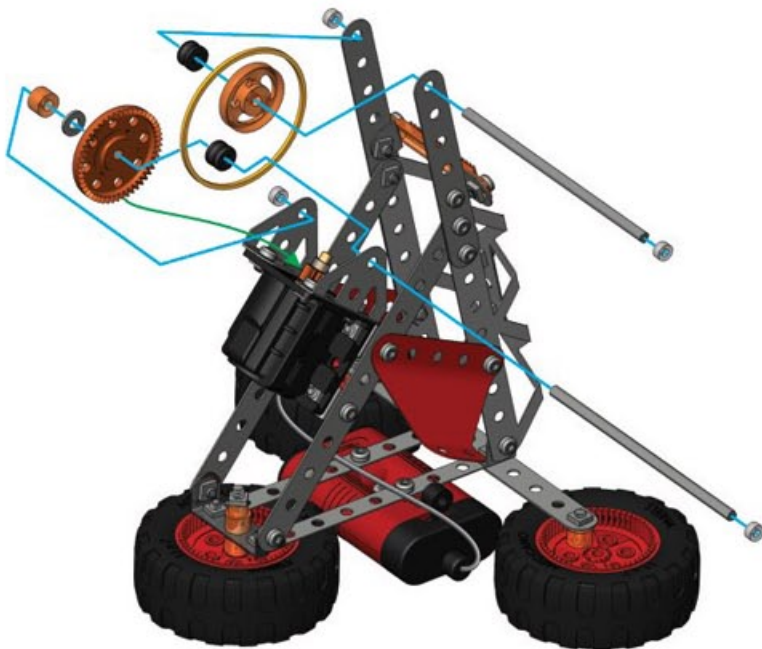

**7**

	x3
	x4
	x1
	x1
	x2
	x3
	x3

**8**



	x2
	x1
	x1
	x2
	x4
	x1
	x1

**9**

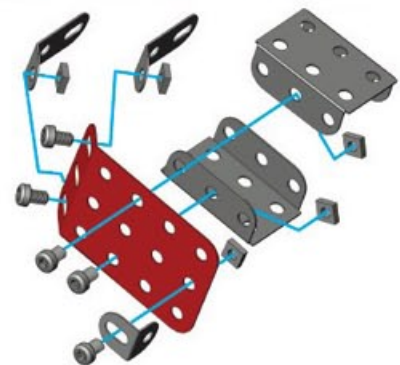
	x1
	x2
	x1
	x2
	x5
	x5







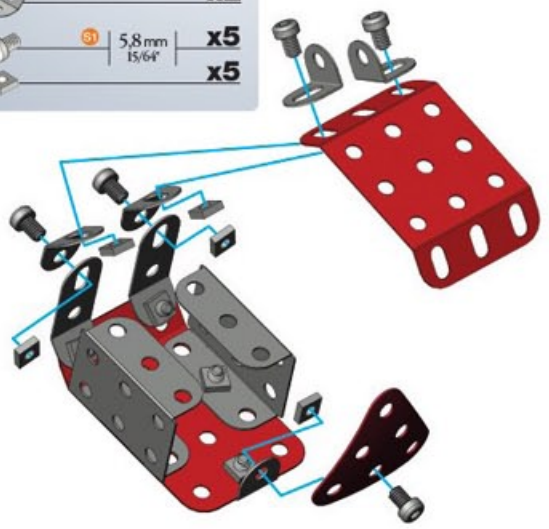



10

-  x1
-  x1
-  x2
-  x2
-  (S1) 5,8mm 15/64" x5
-  x5







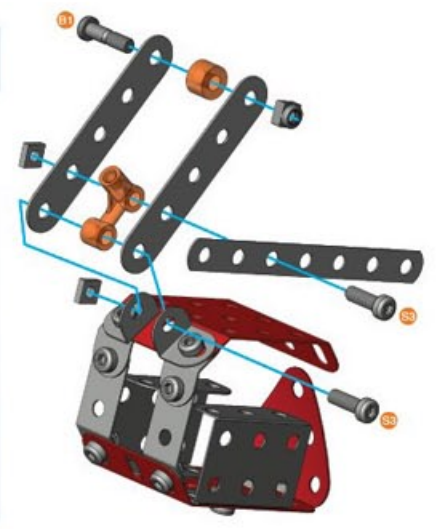

11

-  x1
-  x2
-  x1
-  x1
-  (S1) 14,7mm 37/64" x1
-  (S2) 12mm 1/2" x2
-  x2
-  x1



12

-  x2
-  x2
-  x2
-  (S1) 14,7mm 37/64" x1
-  (S2) 12mm 1/2" x1
-  x1
-  x1



9 + 11 + 12 +

13

-  x1

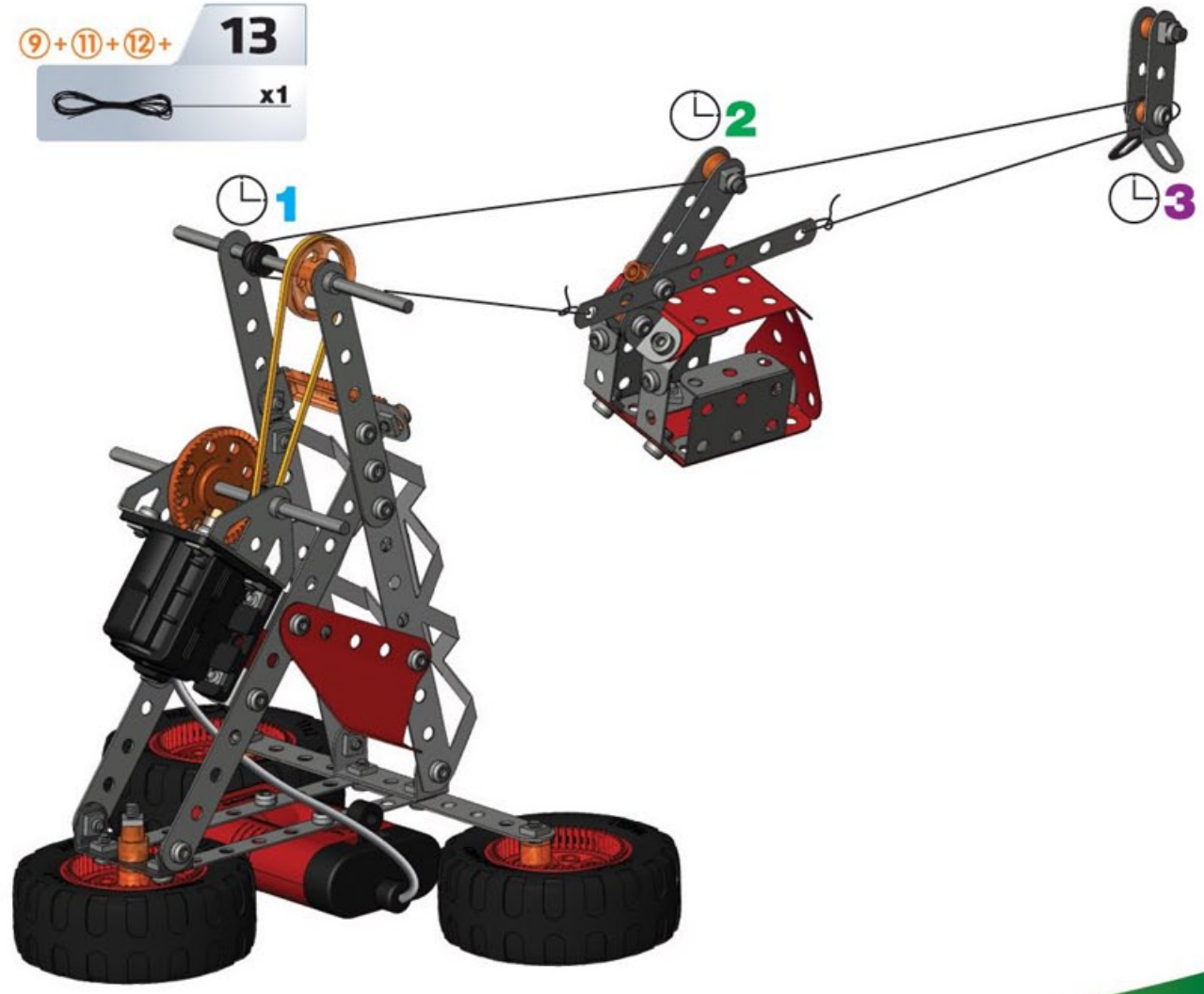





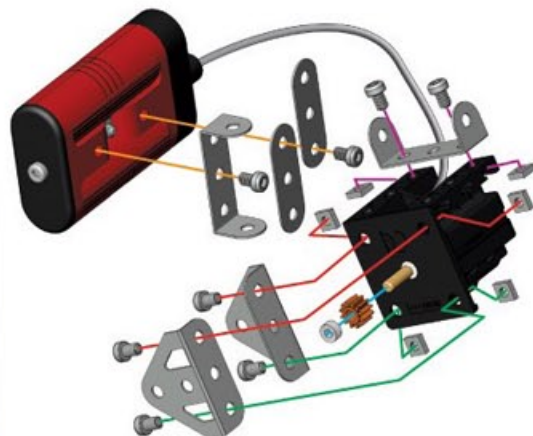

1

-  x1
-  x2
-  x2
-  x2
-  x1
-  x1
-  x8
-  x6



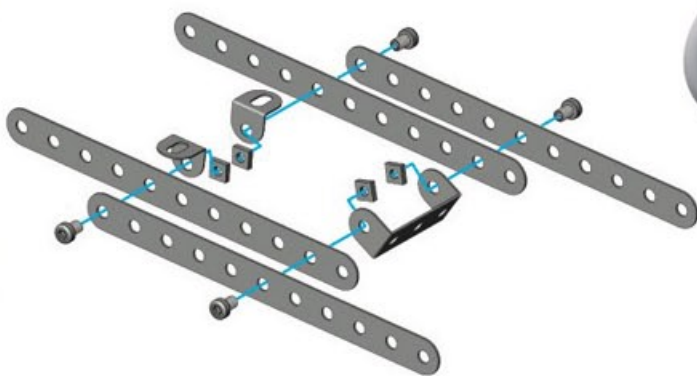

2

-  x4
-  x1
-  x2
-  x4
-  x4



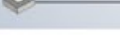

3

-  x2
-  x4
-  x4



①+②+③+

4

-  x1
-  x2
-  x4

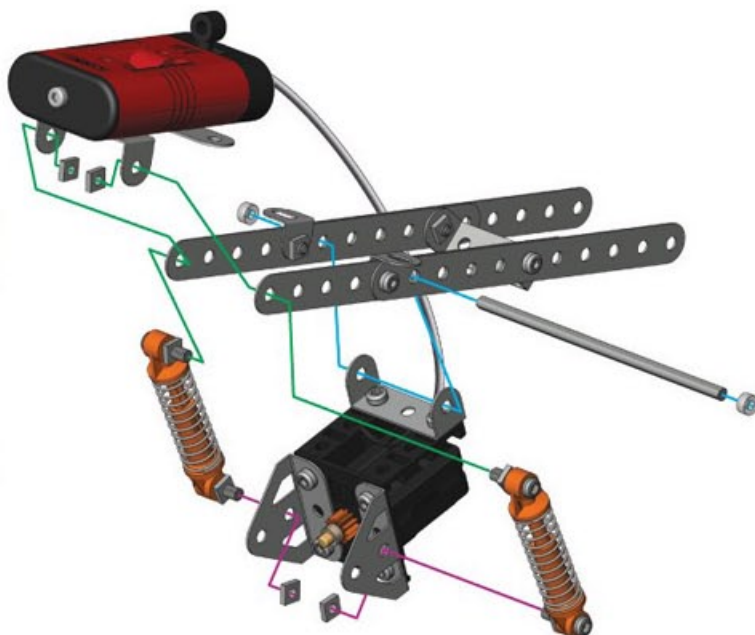

5

	x2
	x2
	x6
	x6



6

	x1		x2
	x1		x1
	x1		x1
	x1		x2
	x1		x2
	x1		x1
	x1		x1

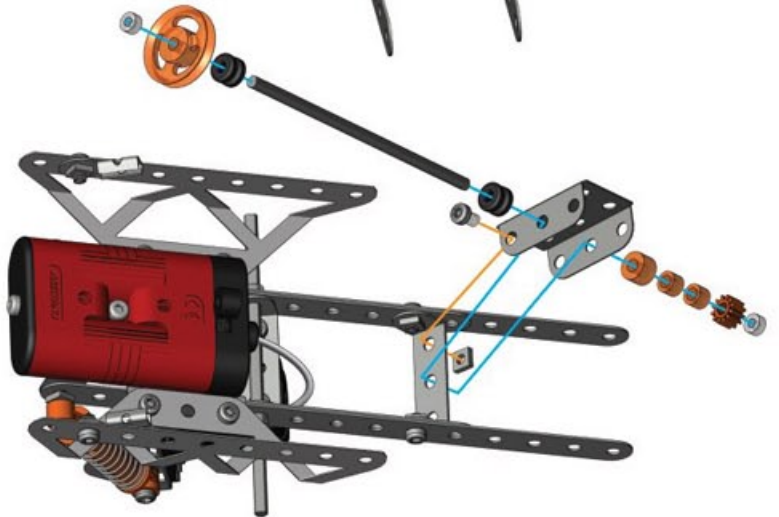

7

	x1		x3
	x1		x1
	x1		x1
	x1		x1
	x1		x5
	x1		x6

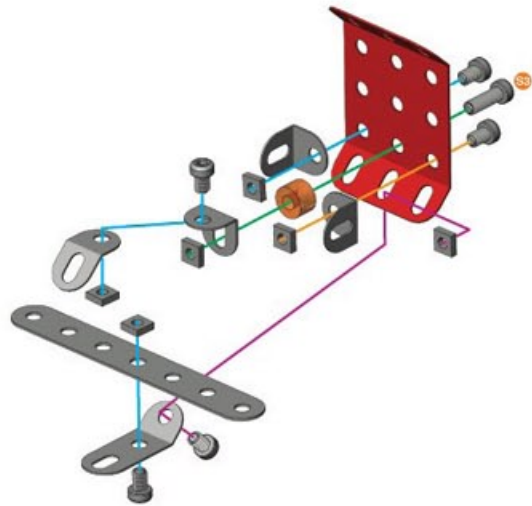

8

	x1
	x1
	x2
	x4
	x4
	x2

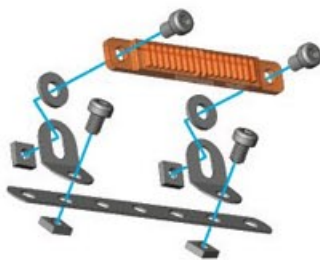





9

	x2
	x4
	x4





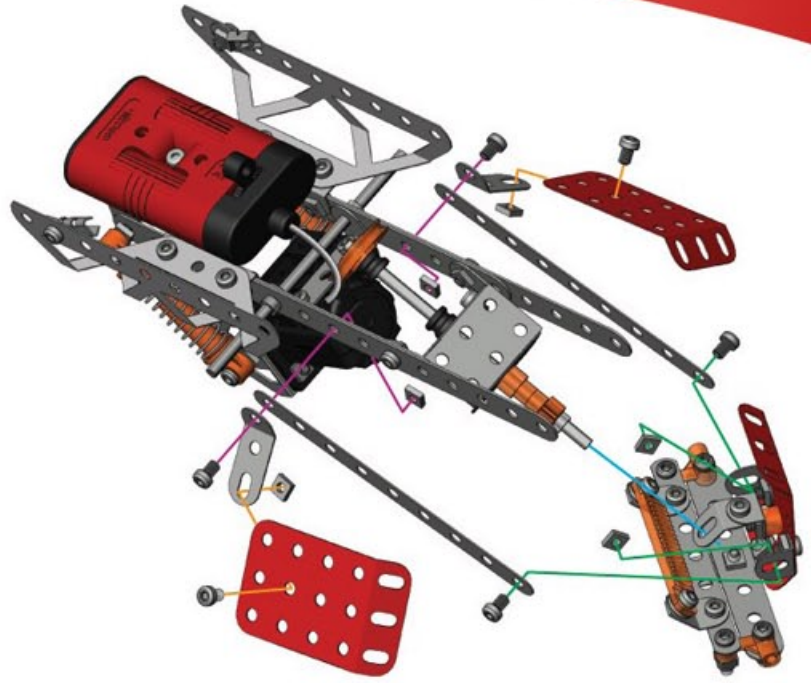

6+9+ **10**

-  x2
-  x2
-  x2
-  x6
-  x6





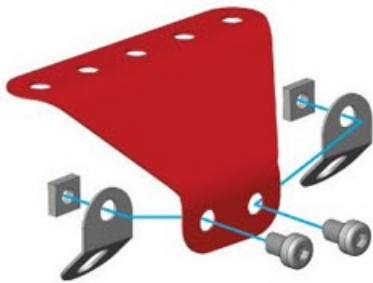

11

-  x2
-  x4
-  x4
-  x4





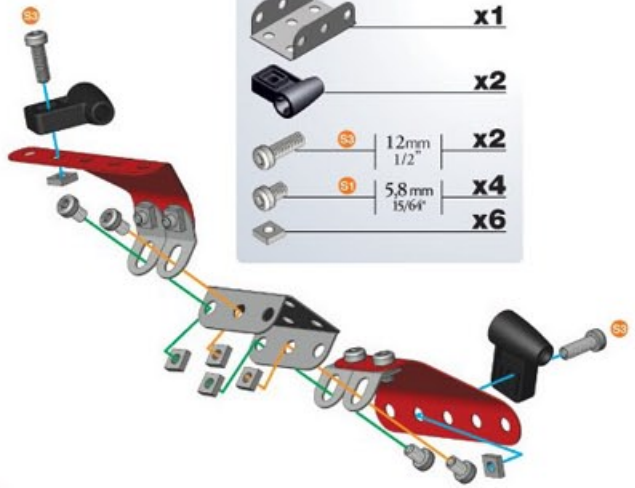

12

-  x1
-  x2
-  x2
-  x4
-  x6





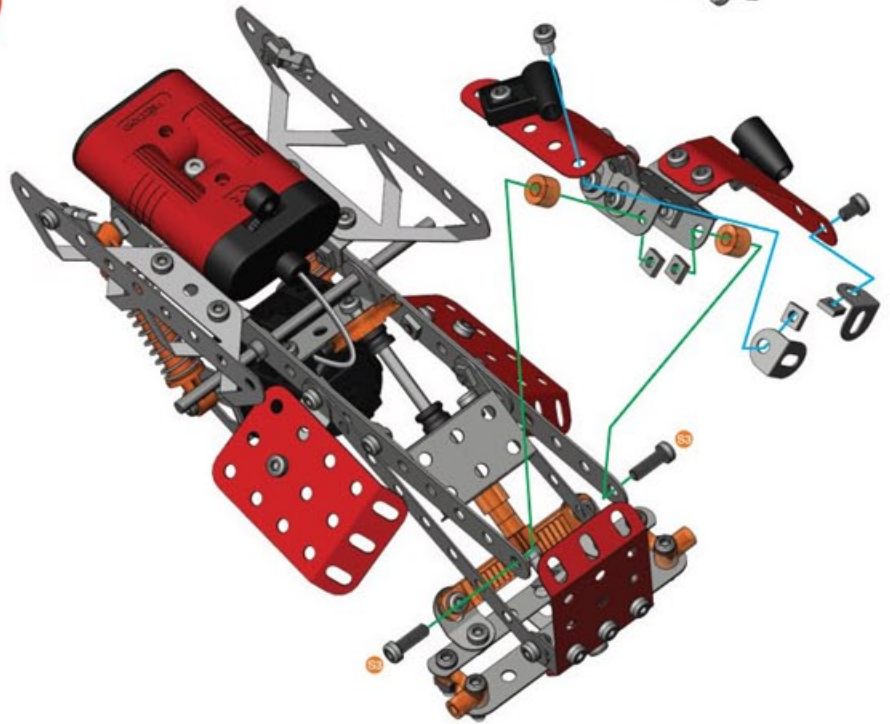

10+12+ **13**

-  x2
-  x2
-  x2
-  x2
-  x4





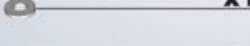

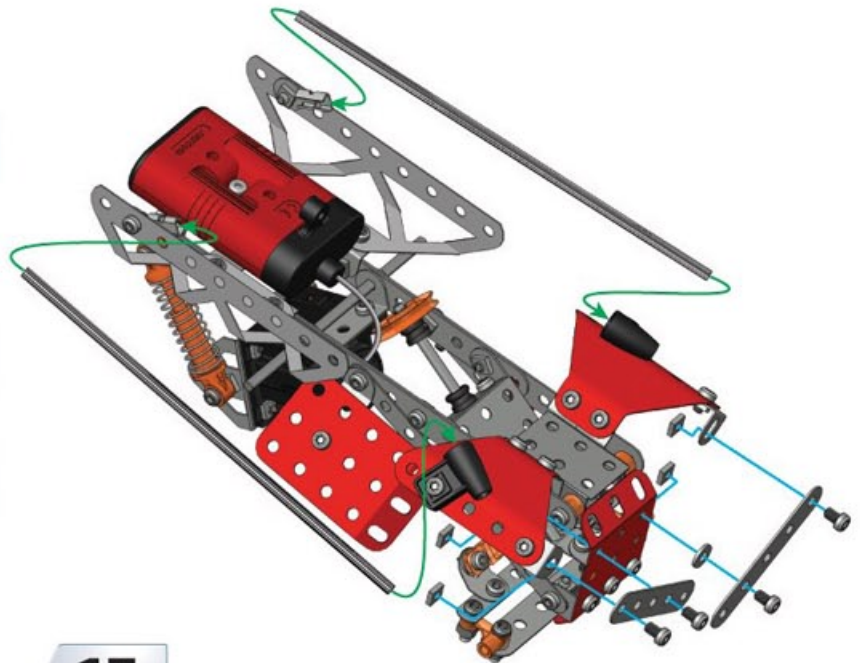





14

-  x2
-  x2
-  5,8mm | 15/64" x4
-  x4
-  x1







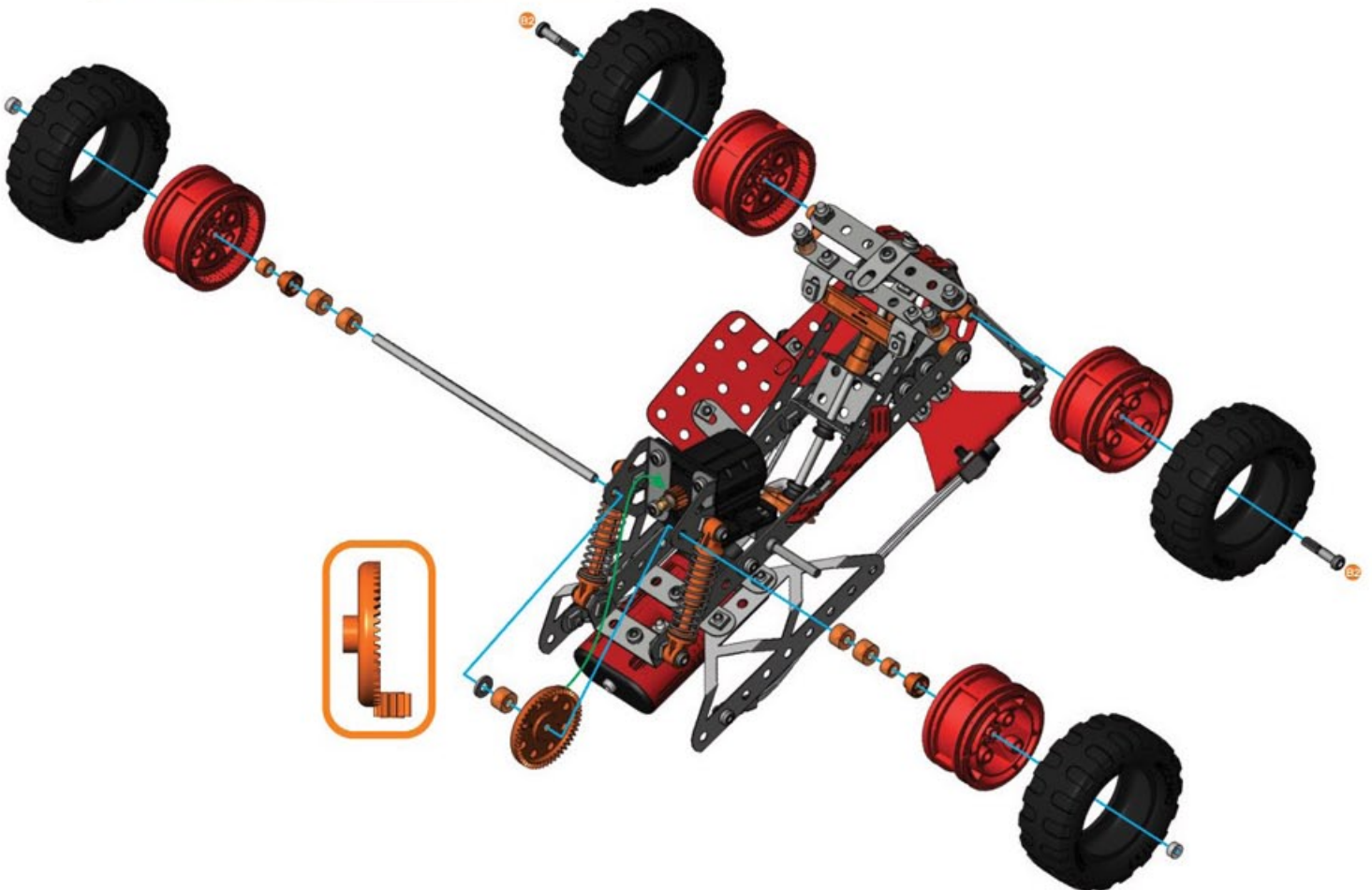























15

-  x4
-  x4
-  x2
-  x1
-  x2
-  130mm | 5 1/8" x1
-  x1
-  x2
-  x5
-  19mm | 3/4" x2







1

-  **x1**
-  **x1**
-  **x2**
-  **x2**
-  **x1**
-  **x1**
-  **x1**
-  **x1**
-  **x1**
-  **x1**
-  **x1**
-  **x1**
-  **x1**
-  **x1**
-  **x1**
-  **x1**
-  **x1**
-  **x1**
-  **x1**
-  **x1**
-  **x1**
-  **x1**
-  **x1**
-  **x1**
-  **x1**
-  **x1**
-  **x1**
-  **x1**







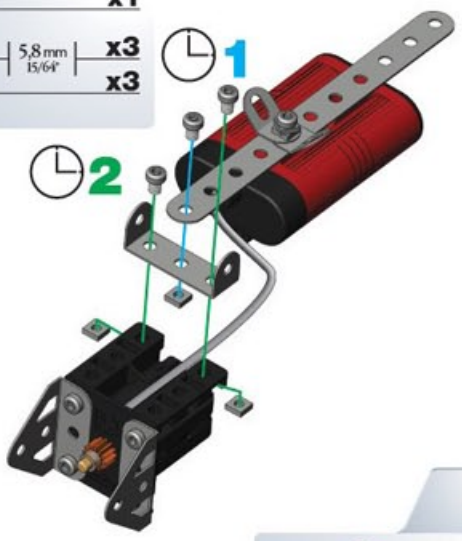

2

-  **x1**
-  **x3**
-  **x3**



3

-  **x1**
-  **x1**
-  **x1**
-  **x2**
-  **x2**
-  **x4**
-  **x4**

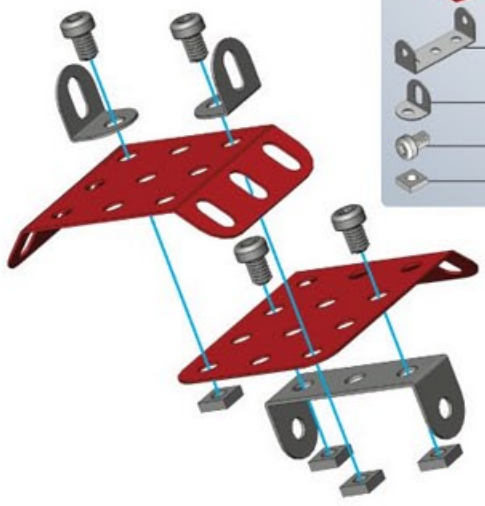





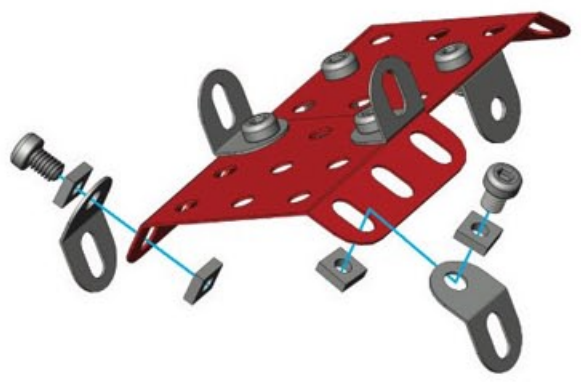

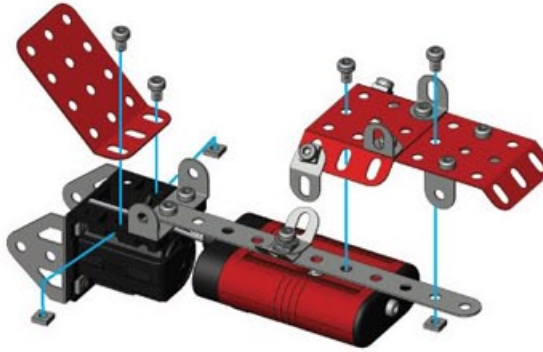
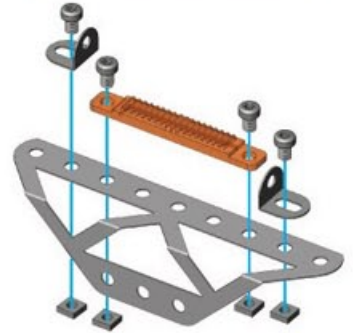
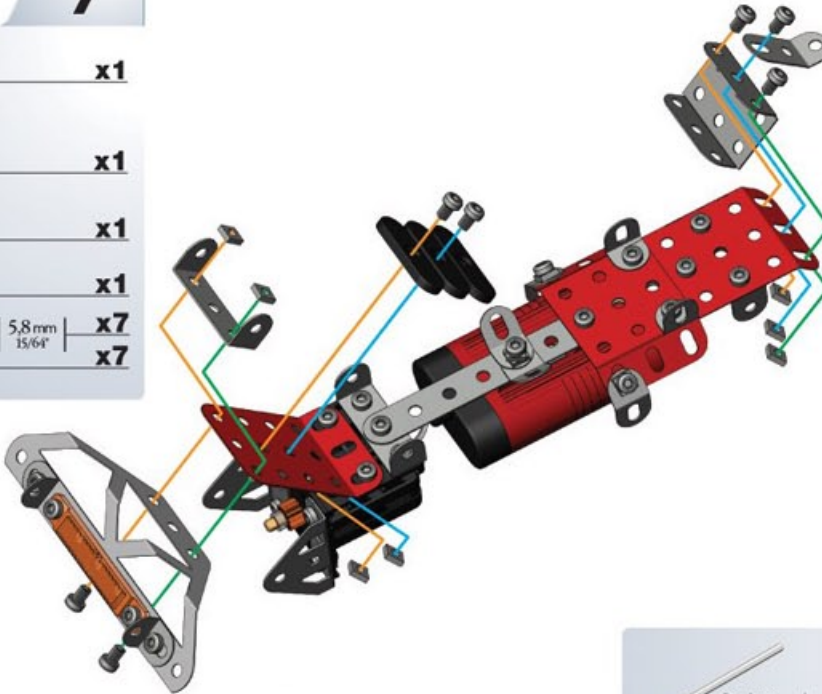
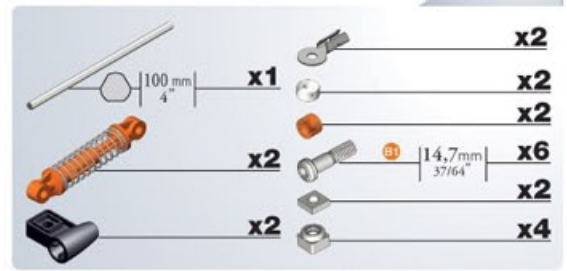
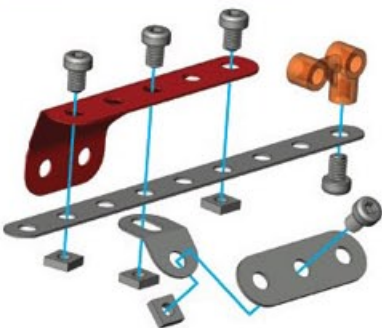
4

-  **x2**
-  **x2**
-  **x4**



5**x1****x4**5,8 mm
15/64"**x3****6****x1****x1****x2****x4****x4****7****5 + 6 +****x1****x1****x1****x1****x7**5,8 mm
15/64"**x7****8****x1**100 mm
4"**x2****x2****x2****x2****x2****x6****x2****x4****x2****x2****x2****x2****x4****9****x1****x1****x1****x1****x1****x5**5,8 mm
15/64"**x4**



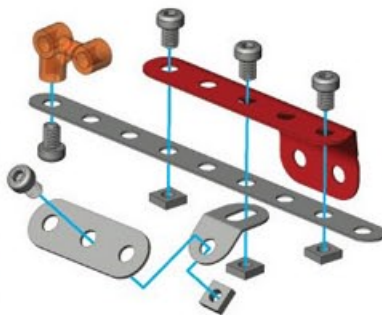

10

-  x1
-  x1
-  x1
-  x1
-  x1
-  $\frac{5,8\text{mm}}{15/64}$ x5
-  x4









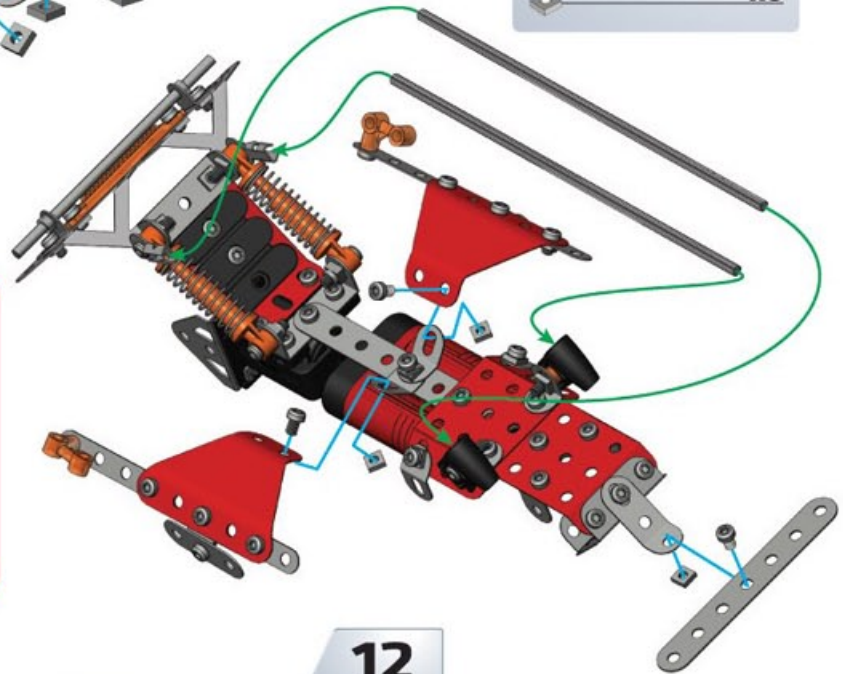



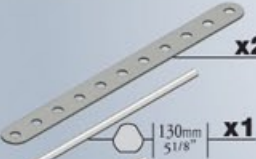

8+9+10+

11

-  x2
-  x1
-  $\frac{5,8\text{mm}}{15/64}$ x3
-  x3



12

-  x4
-  x4
-  x4
-  x2
-  $\frac{130\text{mm}}{51/8}$ x1
-  $\frac{100\text{mm}}{4}$ x1
-  x1
-  x1
-  x2
-  x7
-  x2
-  $\frac{5,8\text{mm}}{15/64}$ x2
-  x2

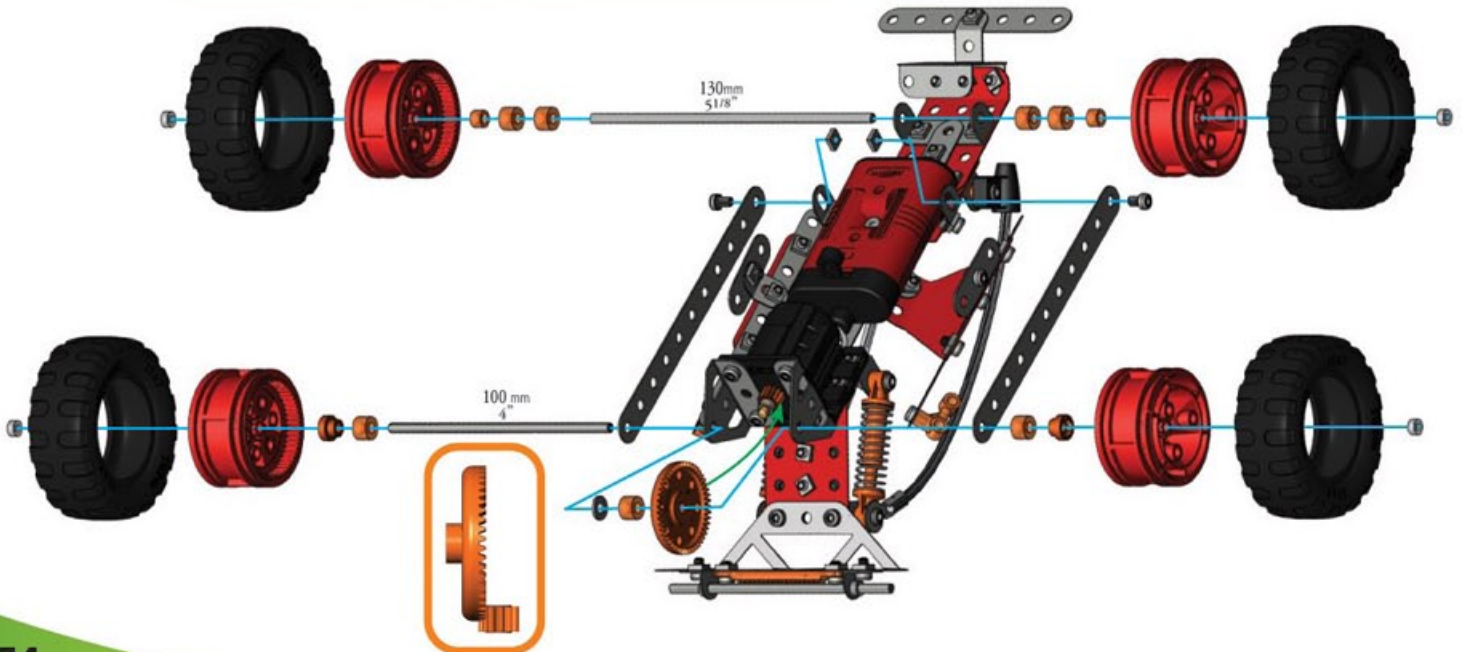



1

	x1		x1
	x1		x1
	x1		x1
	x1		x6
			x4

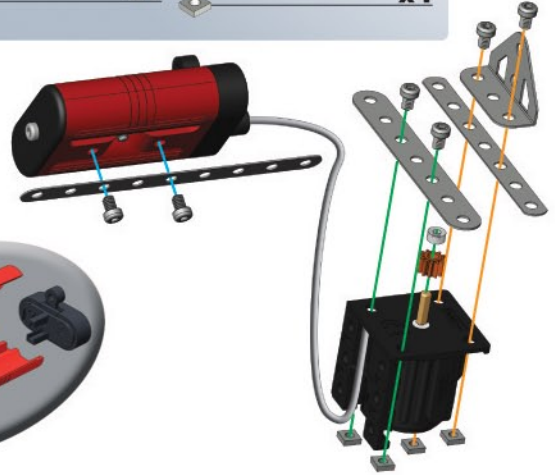

3

	x1		x1
	x2		x1
	x1		x6
	x1		x6

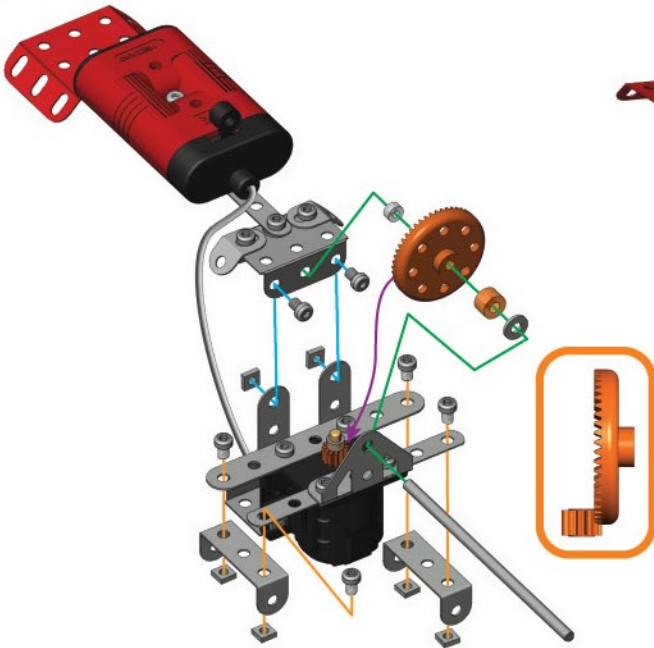

2

	x1		x2
	x2		x2
			x8
			x8
			x1

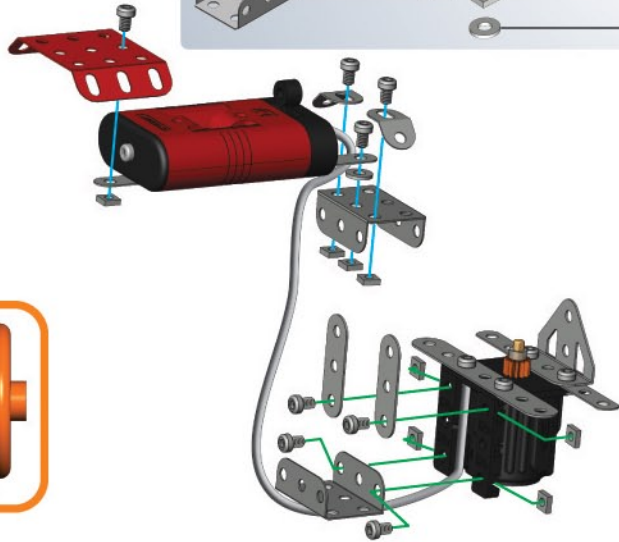



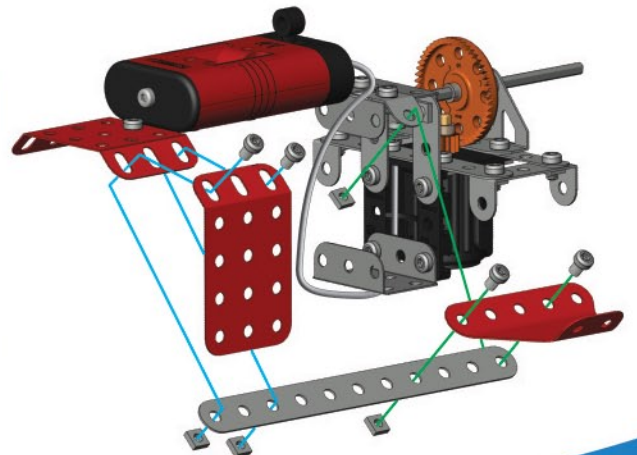

4

	x1		x1
	x4		x1
	x4		





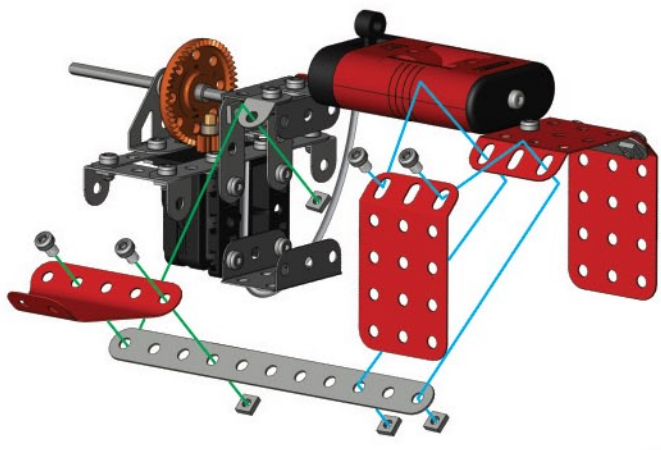

5

-  x1
-  x1
-  x1
-  x4
-  x4





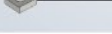

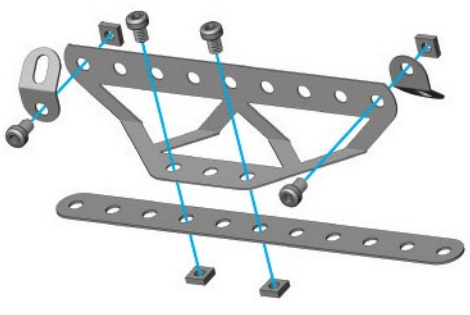
6

-  x1
-  x1
-  x2
-  x4
-  x4

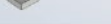

7

-  x1
-  x1
-  x2
-  x4
-  x4

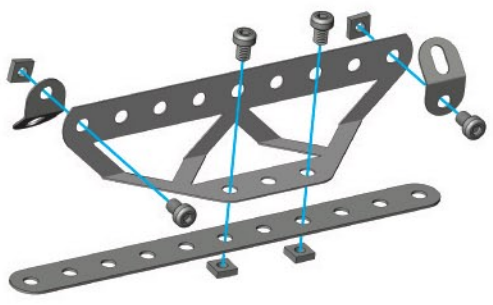





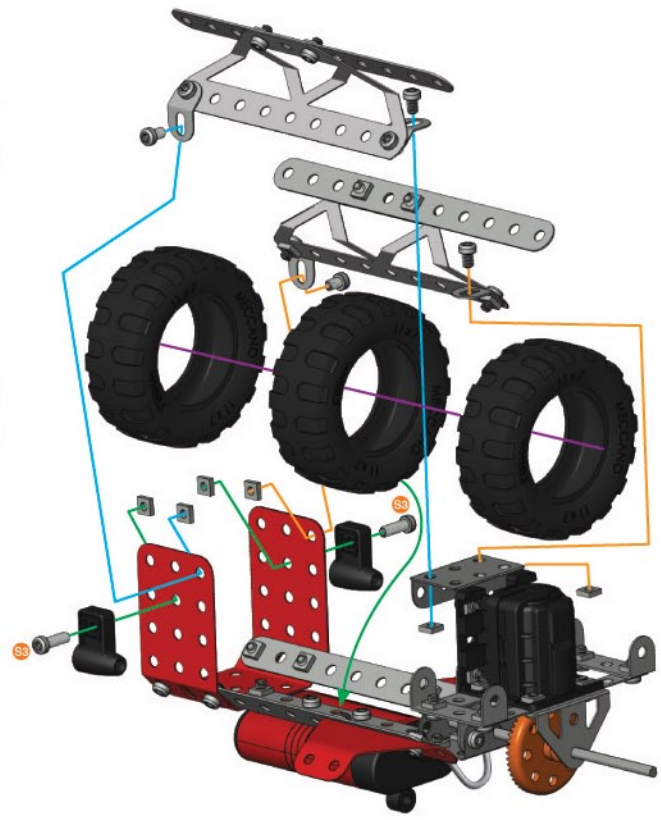

5+6+7+ 8

-  x3
-  x2
-  x2
-  x4
-  x6







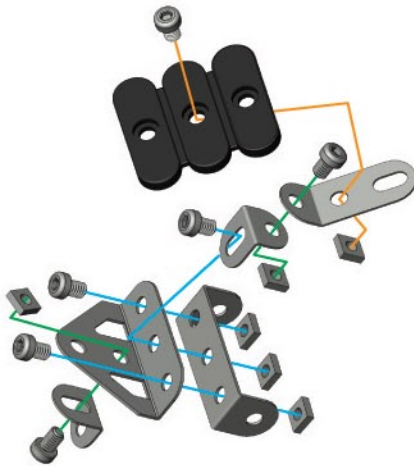



9

-  **x1**
-  **x1**
-  **x1**
-  **x1**
-  **x2**
-  **x6**
-  **x6**







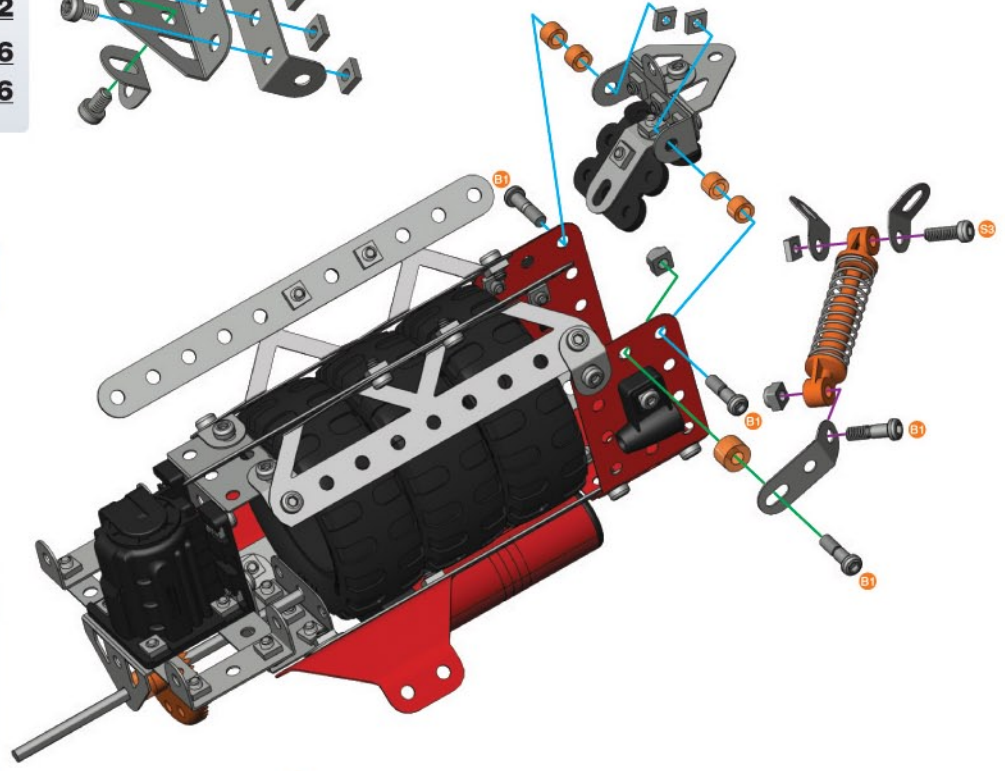

10

8 + 9 +

-  **x1**
-  **x1**
-  **x2**
-  **x1**
-  **x4**
-  **x4**
-  **x1**
-  **x3**
-  **x2**



11

-  **x1**
-  **x1**
-  **x1**
-  **x3**
-  **x1**
-  **x1**
-  **x1**

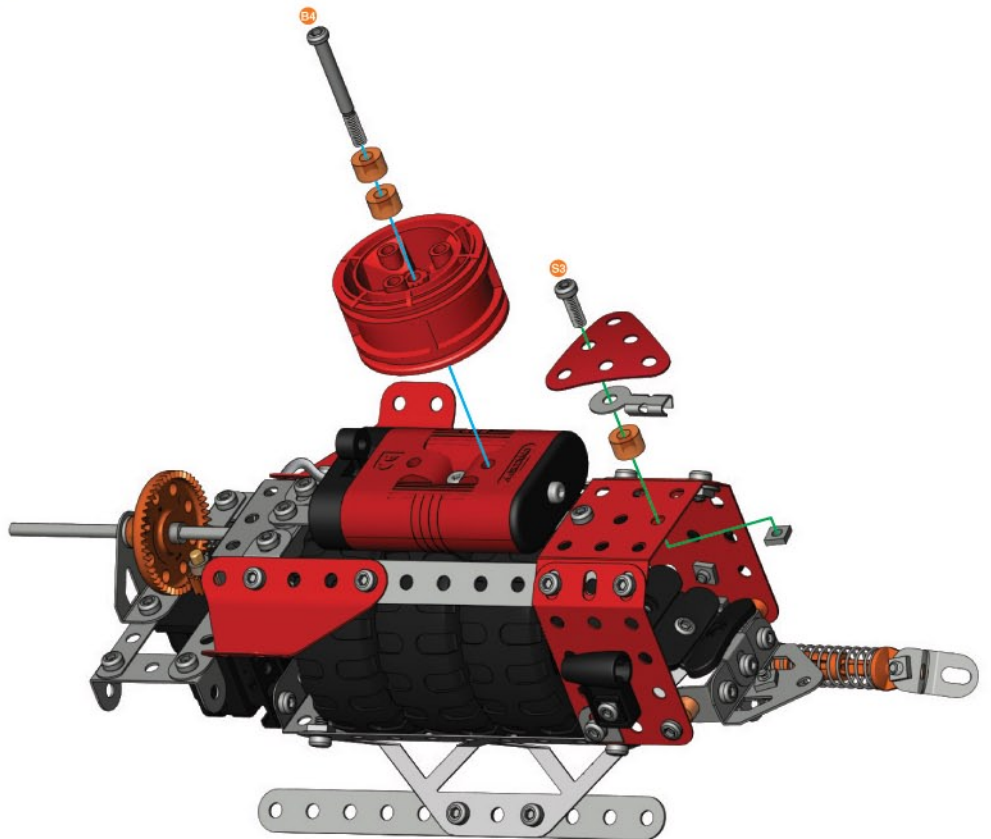

12

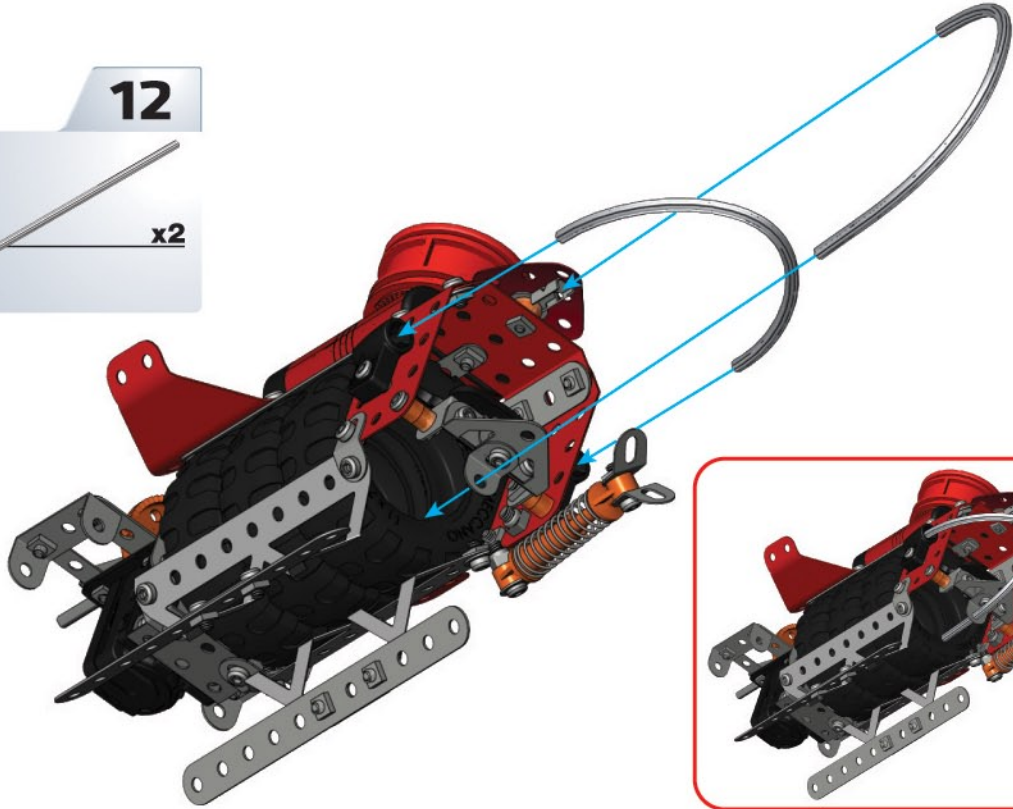
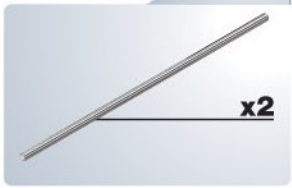

13

	x1		x2
	x1		x1
	x2		x2
	x1		x2
			x4
			x2
			x1

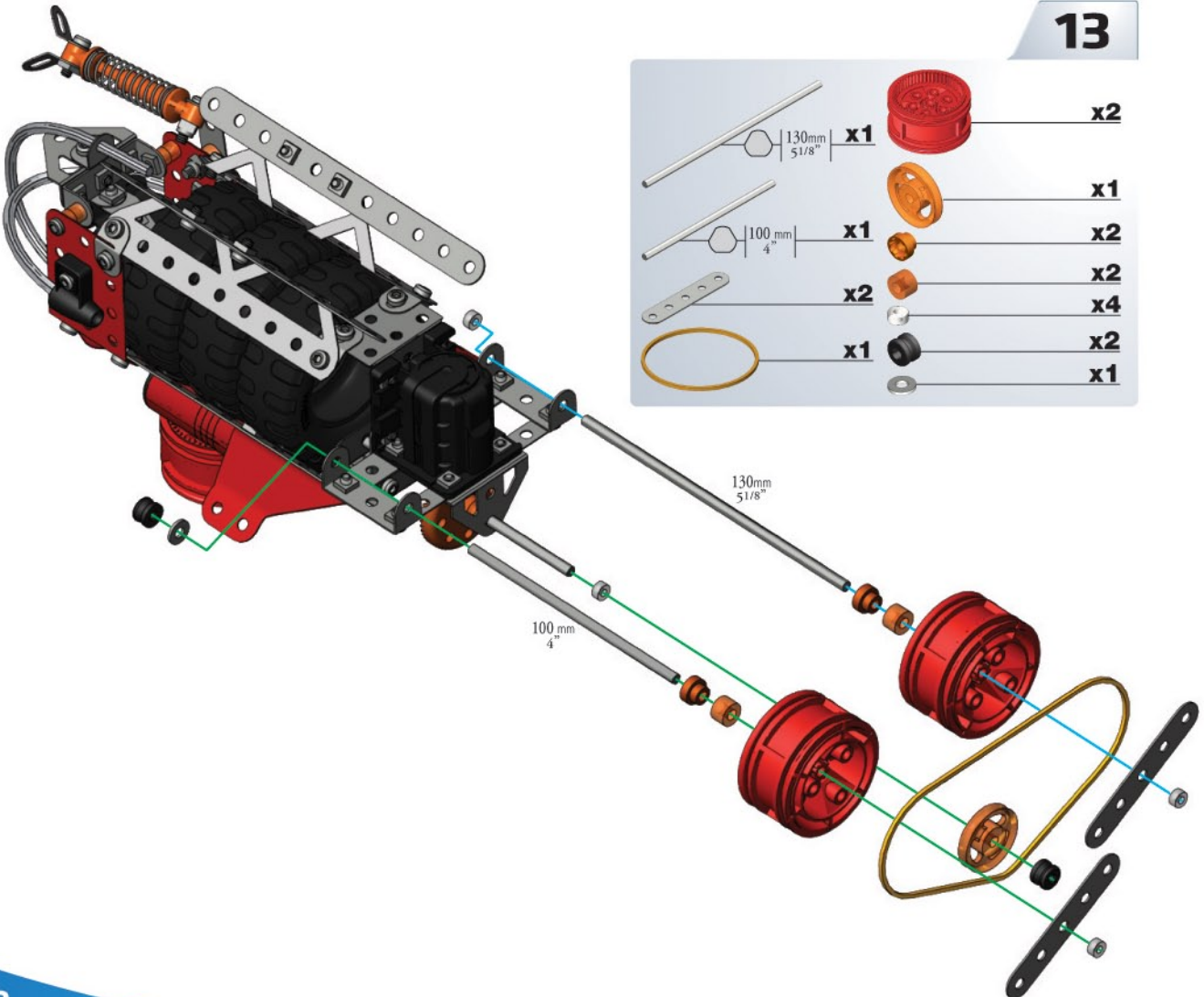

1



	x1		x2
	x2		x1
	x2		x1
			x6
			x4

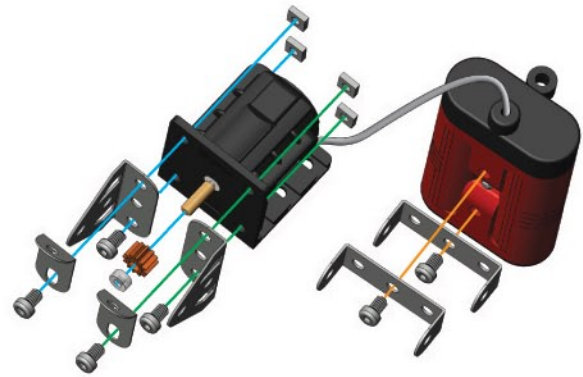

2

	x1
	x1
	x2
	x4
	x2

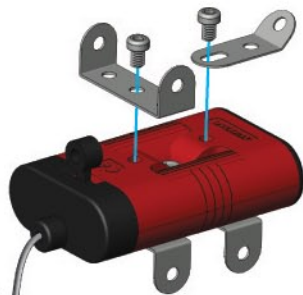

3

	x2
	x4
	x4

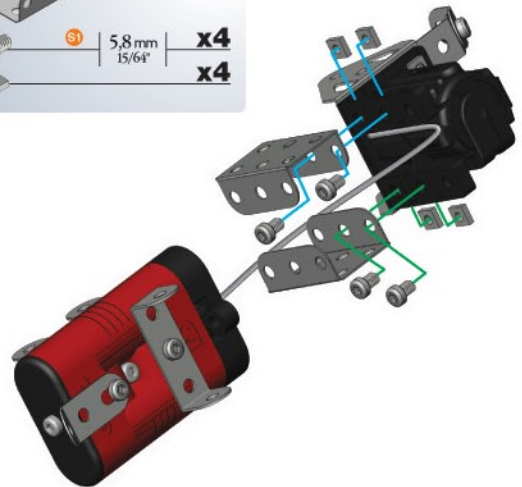





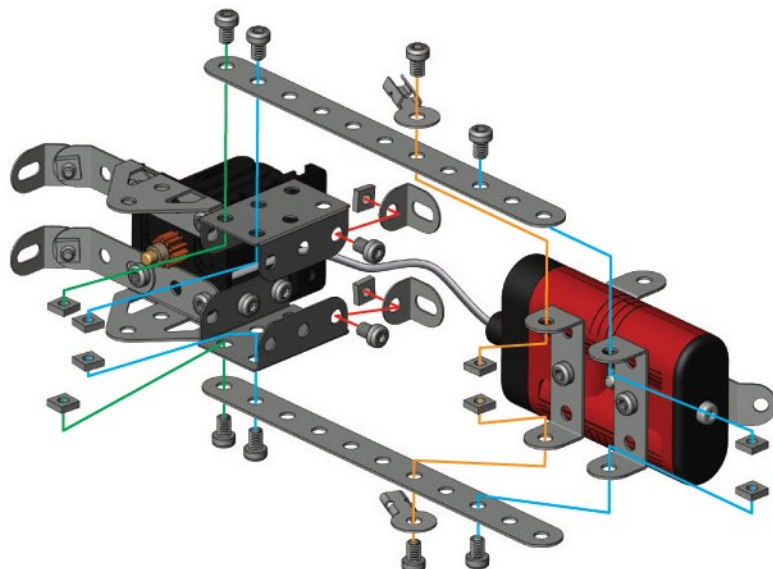



4

	x2
	x2
	x2
	x10
	x10





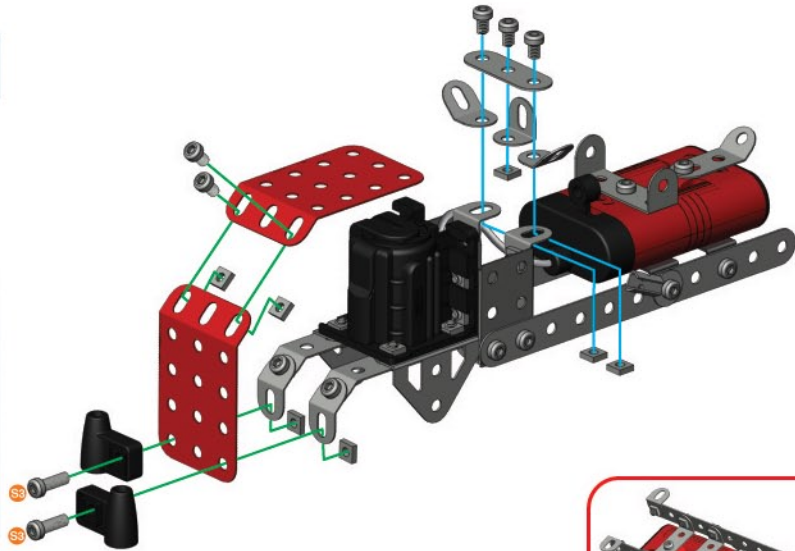

5

-  **x2**
-  **x2**
-  **x1**
-  **x2**
-  **x1**
-  **x2**
-  **x5**
-  **x7**





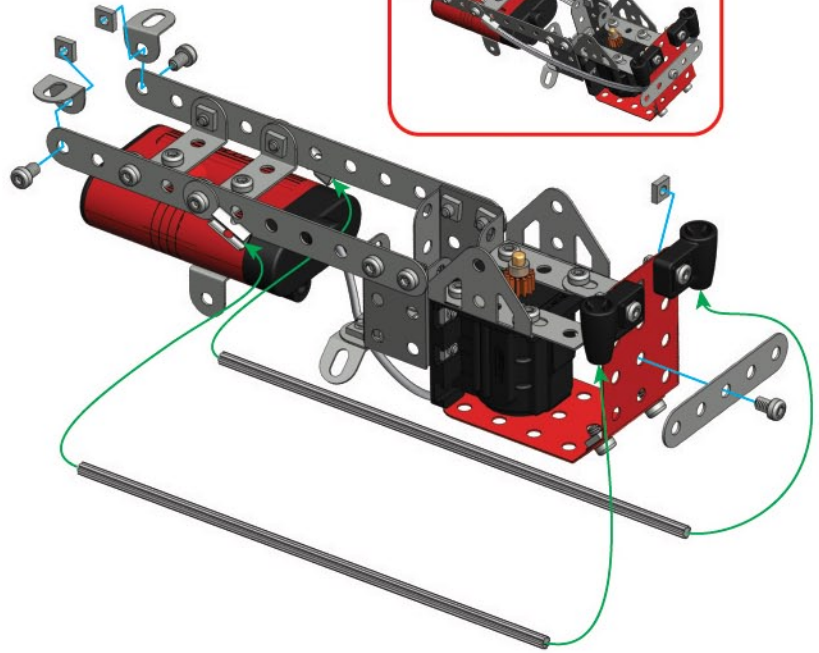

6

-  **x2**
-  **x1**
-  **x2**
-  **x3**
-  **x3**





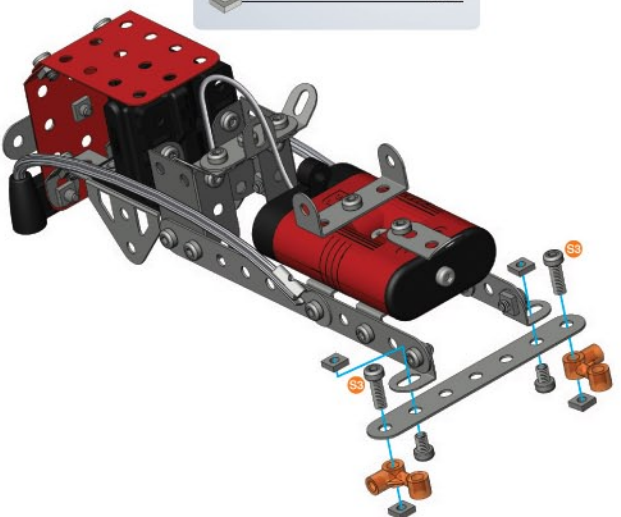

7

-  **x1**
-  **x2**
-  **x2**
-  **x2**
-  **x4**







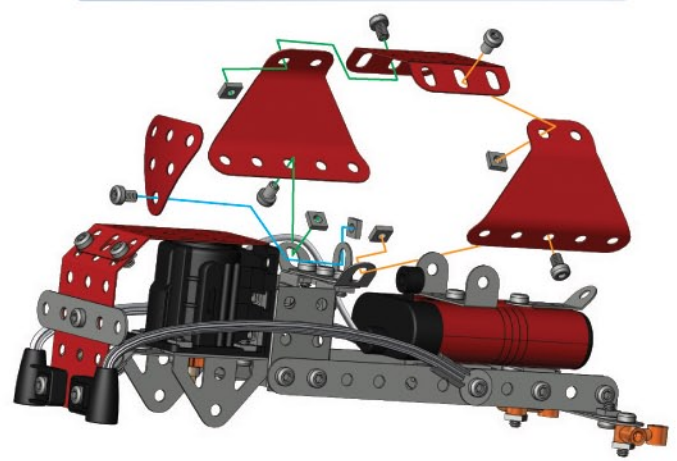

8

-  **x2**
-  **x1**
-  **x1**
-  **x5**
-  **x5**





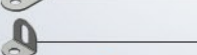

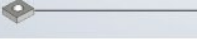

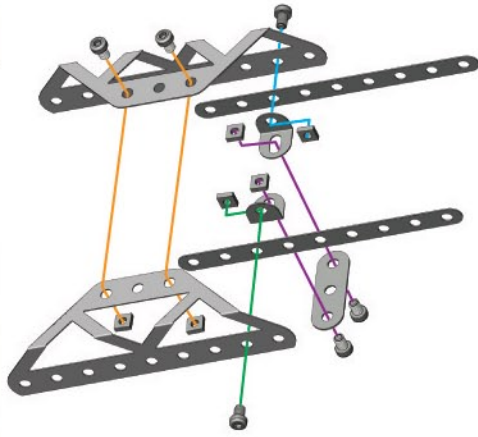





10

9





-  x2
-  x2
-  x1
-  x2
-  x2
-  x6
-  x6



-  100mm | 4" | x1
-  x1
-  x1
-  x1
-  x3
-  x1
-  x2
-  x4
-  38.1mm | 1 1/2" | x1
-  14.7mm | 37/64" | x2
-  5.8mm | 15/64" | x2
-  5.8mm | 15/64" | x7





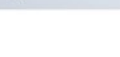

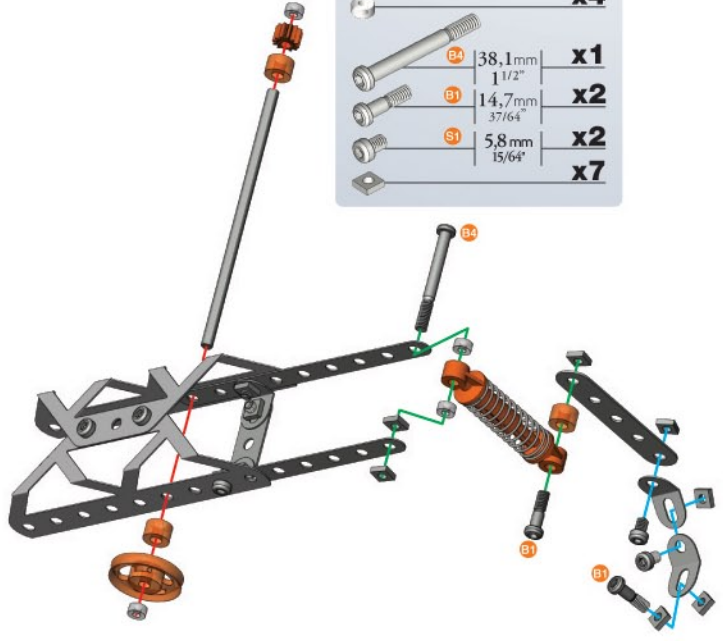
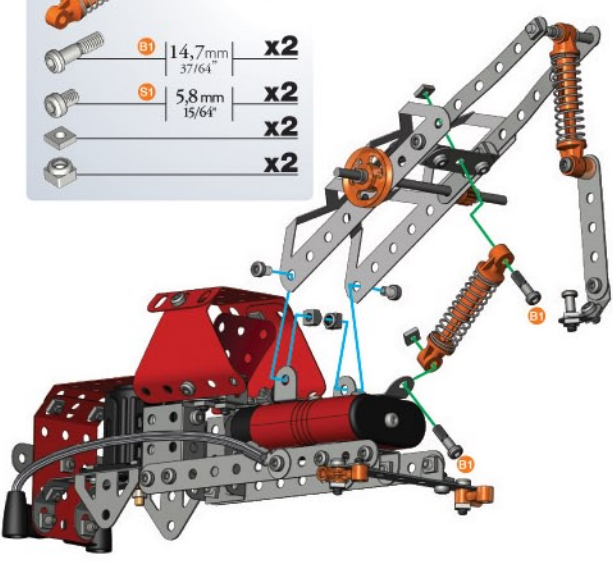



11

8 + 10 +

-  x1
-  14.7mm | 37/64" | x2
-  5.8mm | 15/64" | x2
-  5.8mm | 15/64" | x2
-  5.8mm | 15/64" | x2



12

-  x4
-  x4
-  x1
-  19mm | 3/4" | x1
-  130mm | 5 1/8" | x1
-  x2
-  x4
-  x2
-  x2
-  x2
-  x1

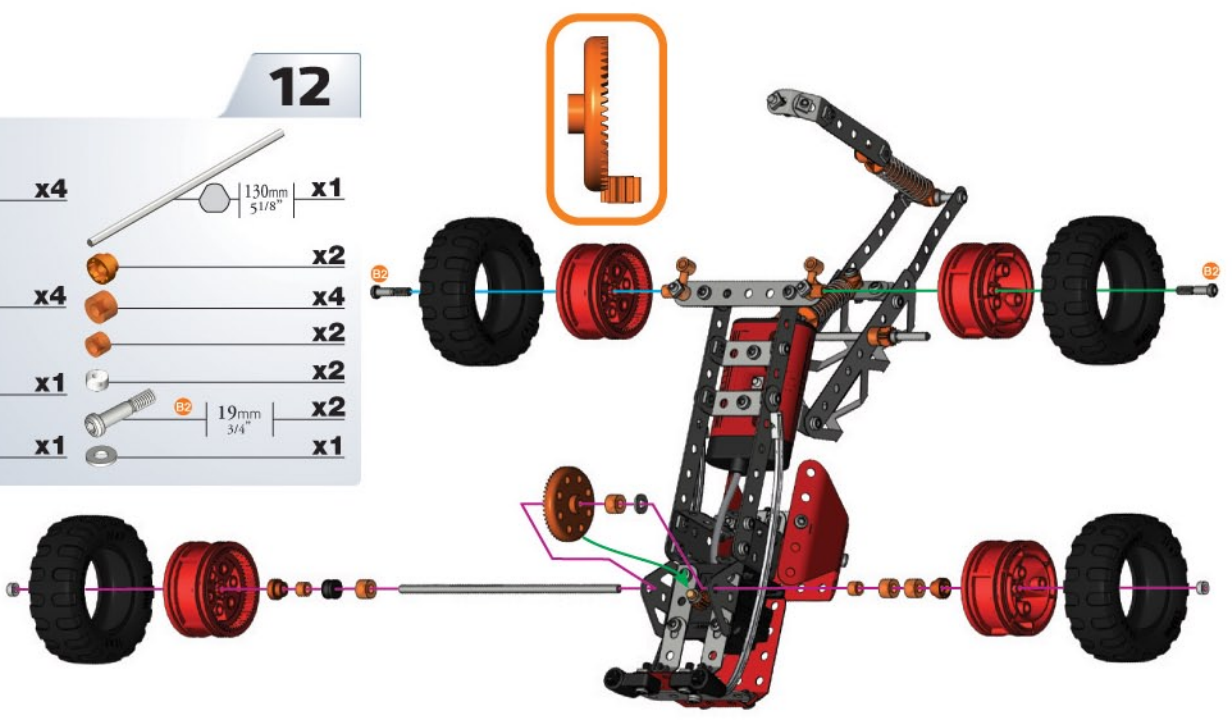



1

	x1		x1
	x2		x1
	x1		x1
			5,8 mm 15/64" x6
	x1		x4

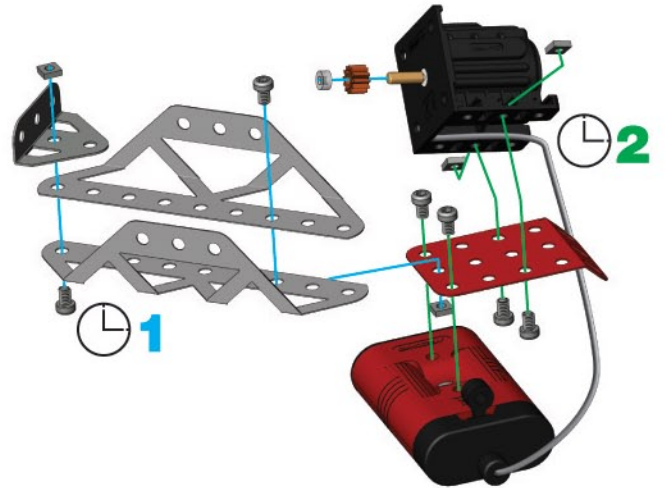

2

	x1
	x1
	x3
	x1
	12 mm 1/2" x1
	5,8 mm 15/64" x3
	x4

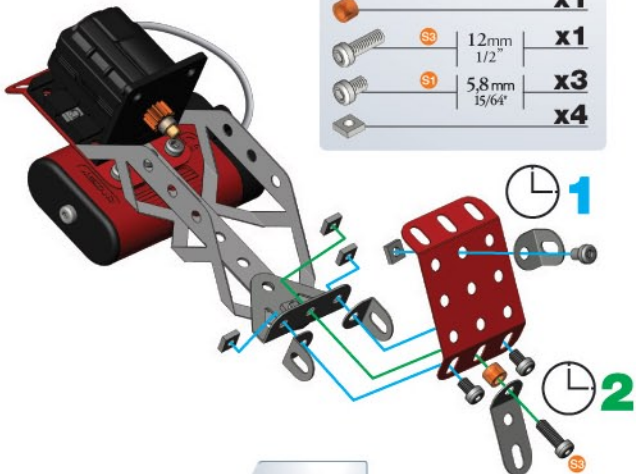

3

	x1		12 mm 1/2" x2
	x2		5,8 mm 15/64" x1
	x3		

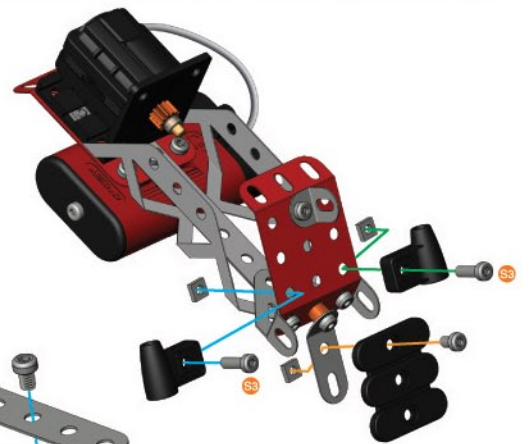



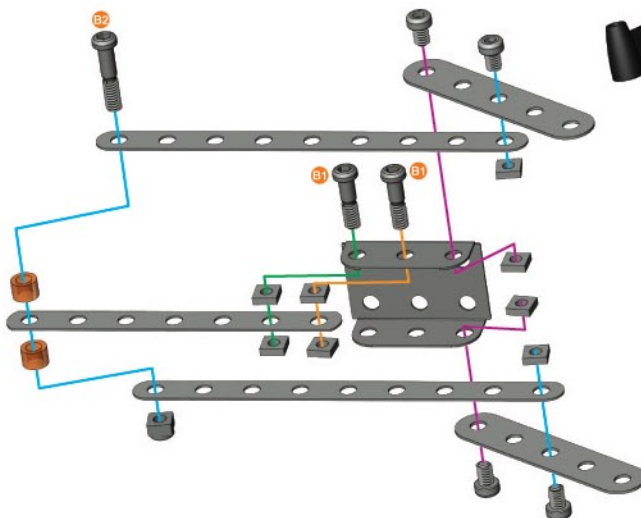

4

	x2
	x1
	x2
	x1
	x2
	19 mm 3/4" x1
	14,7 mm 37/64" x2
	5,8 mm 15/64" x4
	x8
	x1









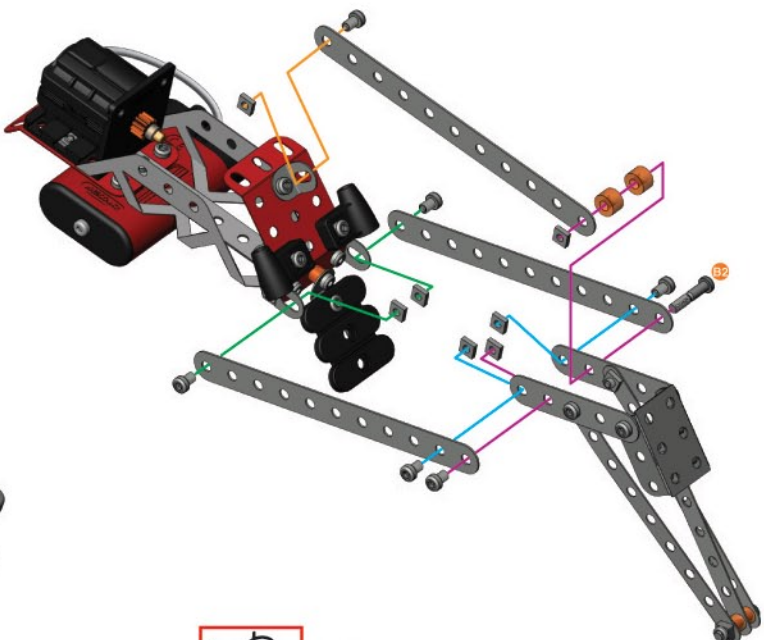

③+④+

5

-  x3
-  x2
-  B2 19mm 3/4" x1
-  S1 5,8mm 15/64" x6
-  x7

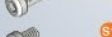





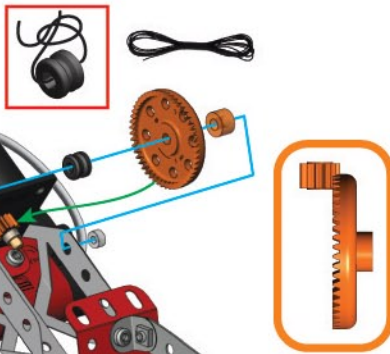
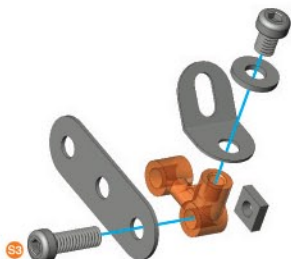

6

-  x1
-  x1
-  x1
-  S6 12mm 1/2" x1
-  S1 5,8mm 15/64" x1
-  x1
-  x1
-  x1







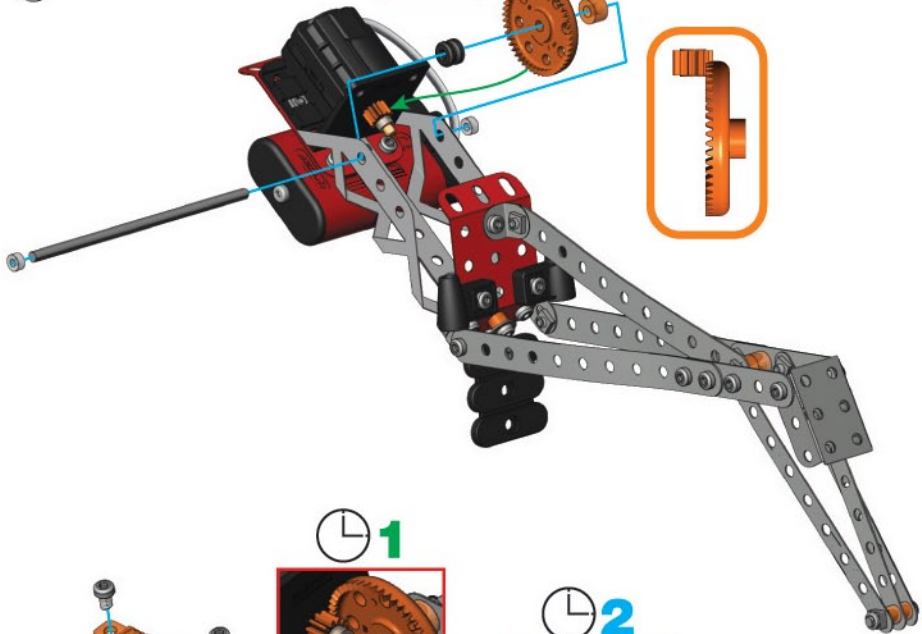

7

-  x1
-  x1
-  x1
-  x1
-  x1
-  x1



⑥+⑦+

8

-  x1
-  x1
-  x1
-  x1
-  S1 5,8mm 15/64" x5
-  x4

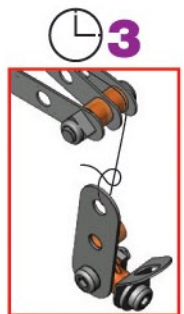
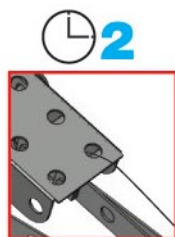
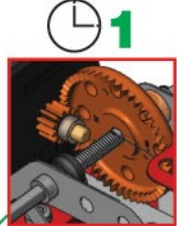
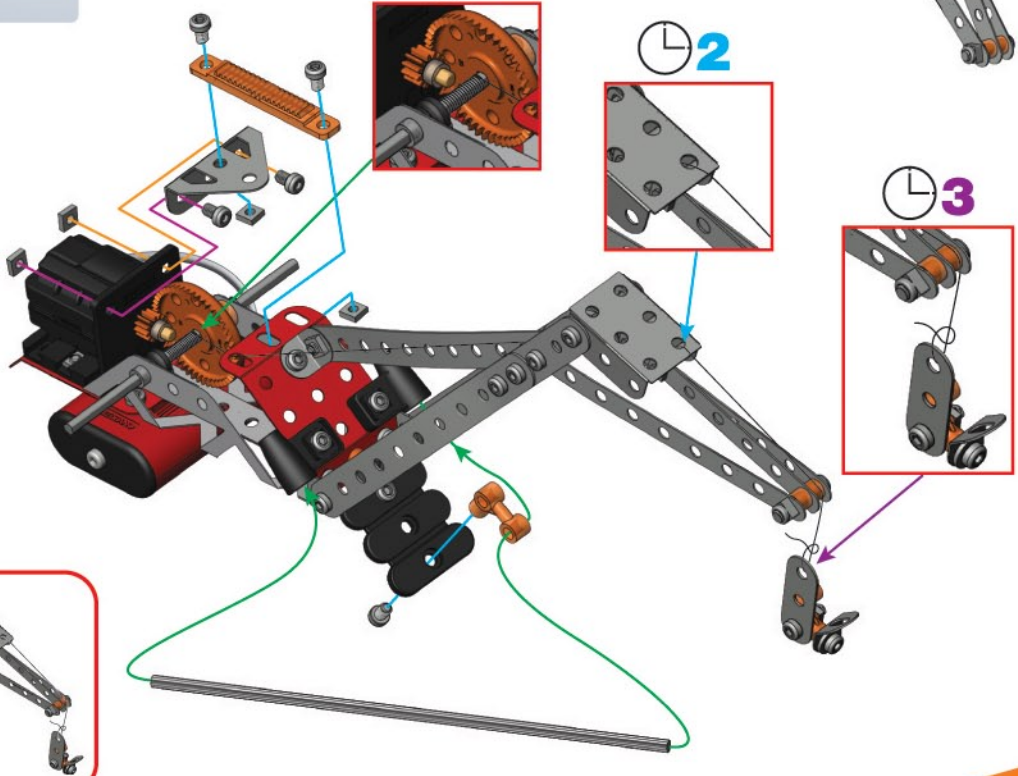

9



x2



x4



St

5,8 mm

x4

15/64"

x4

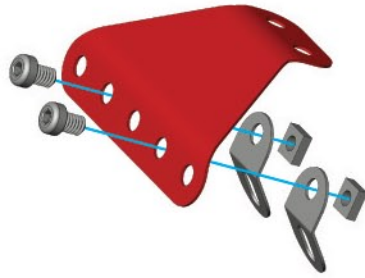

x2



10



x1



x3



x1



x1



x3



x3



St

14,7 mm

x3

St

5,8 mm

x4

St

15/64"

x7

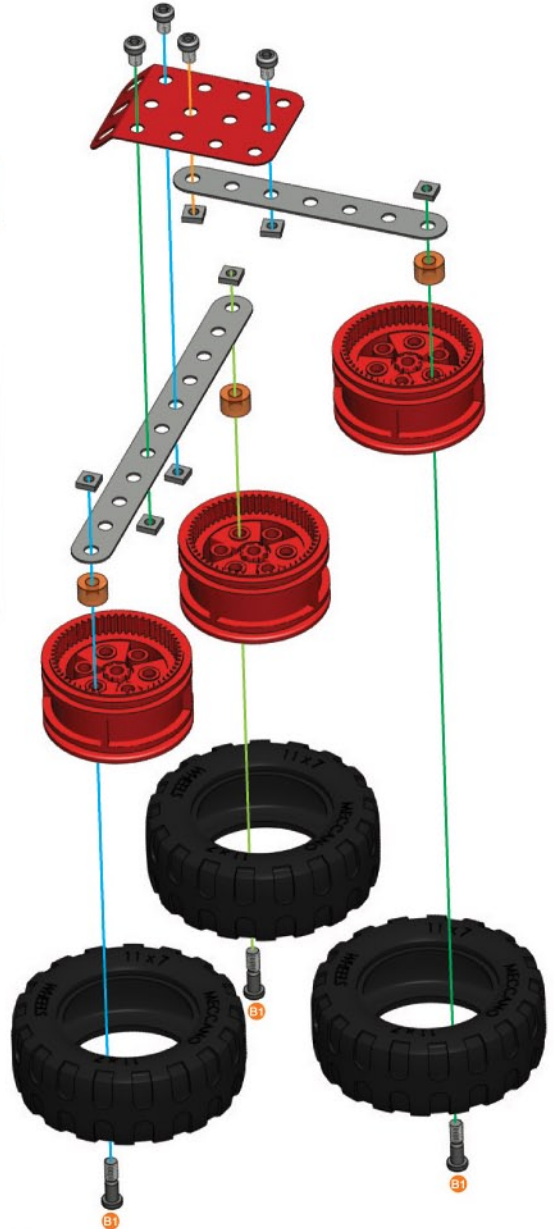
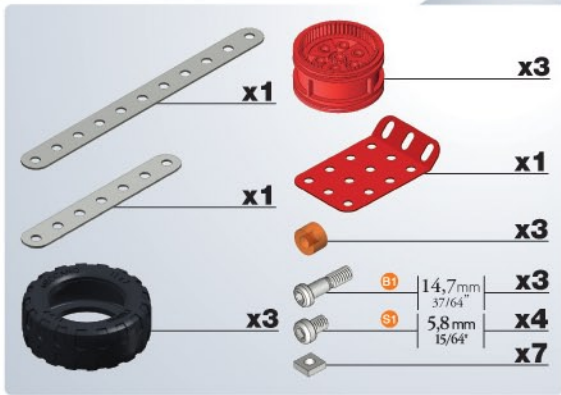

9 + 10 +

11



x3



St

5,8 mm





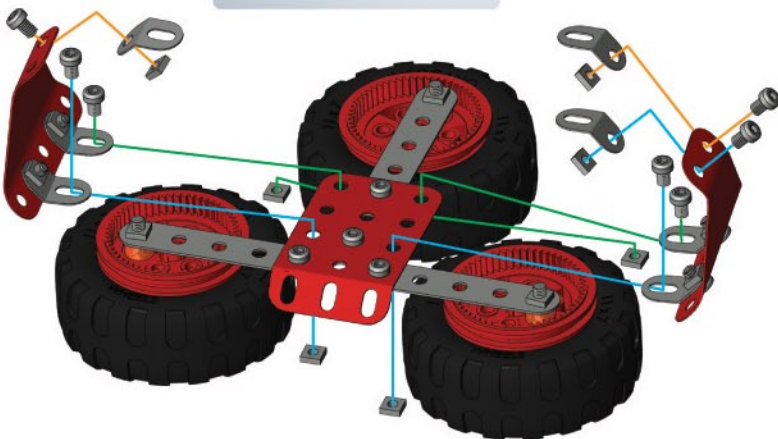

x7



x7



12

-  x1
-  x3
-  x2
-  x1
-   5,8mm | 15/64" x9
-  x9

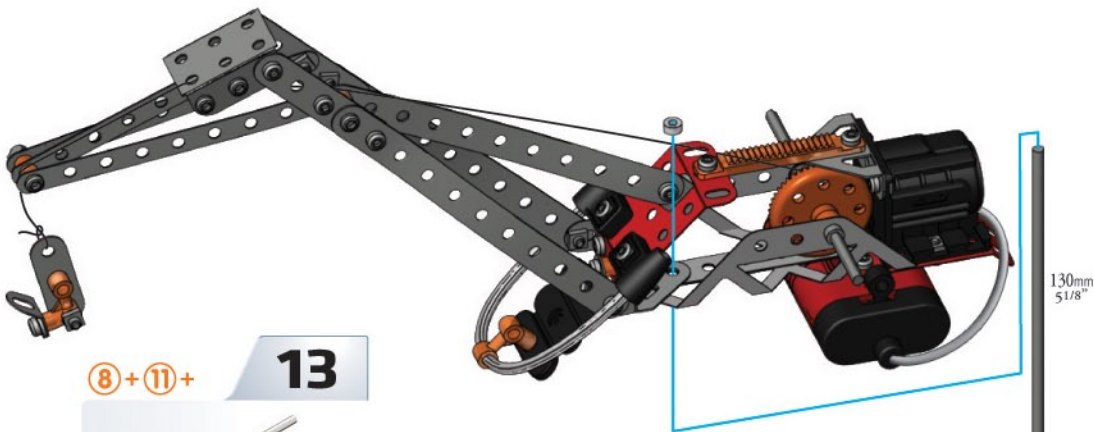
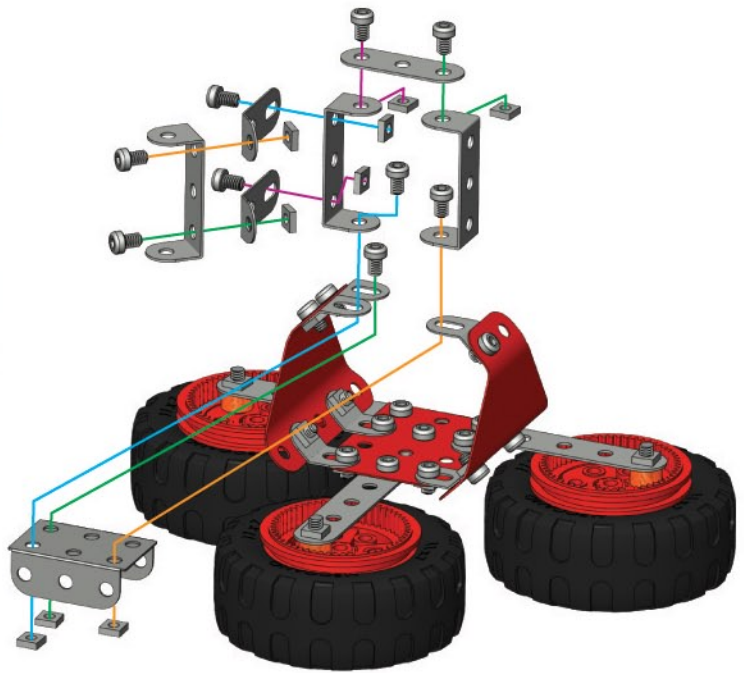

⑧ + ⑪ +





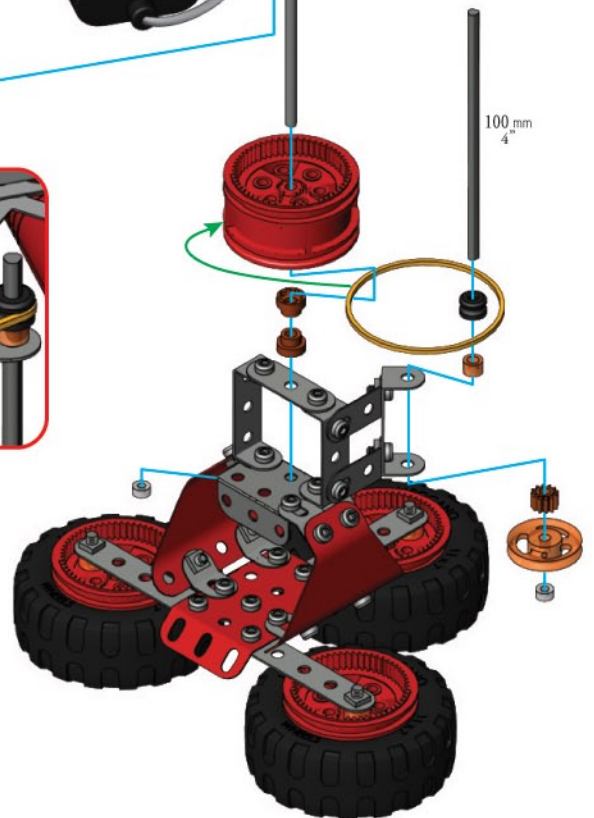
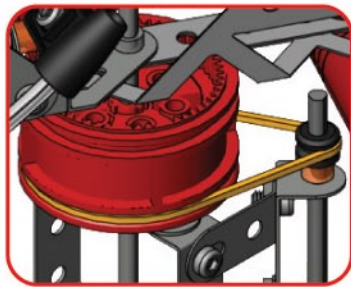



13

-  130mm | 5 1/8" x1
-  100mm | 4" x1
-  x1
-  x1
-  x1
-  x1
-  x2
-  x1
-  x1
-  x3







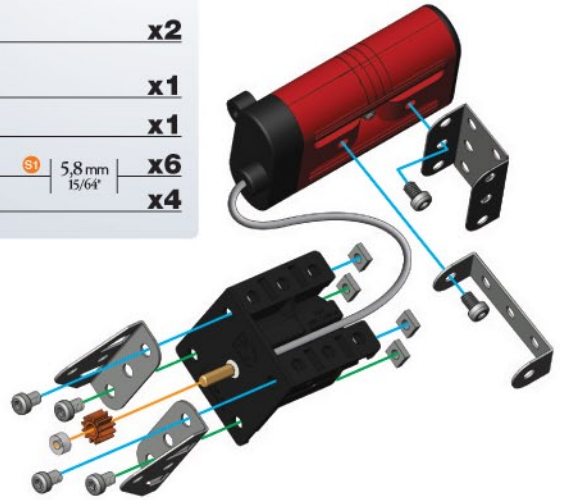

1

-  **x1**
-  **x1**
-  **x1**
-  **x2**
-  **x1**
-  **x1**
-  **x6** | 5,8mm | 15/64"
-  **x4**









2

-  **x1**
-  **x1**
-  **x1** | 12mm | 1/2"
-  **x1** | 5,8mm | 15/64"
-  **x2**



3

-  **x2**
-  **x1**
-  **x1**
-  **x3**
-  **x7** | 5,8mm | 15/64"
-  **x7**

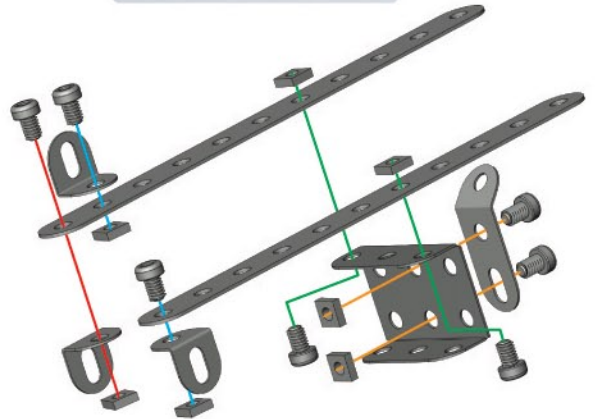

4



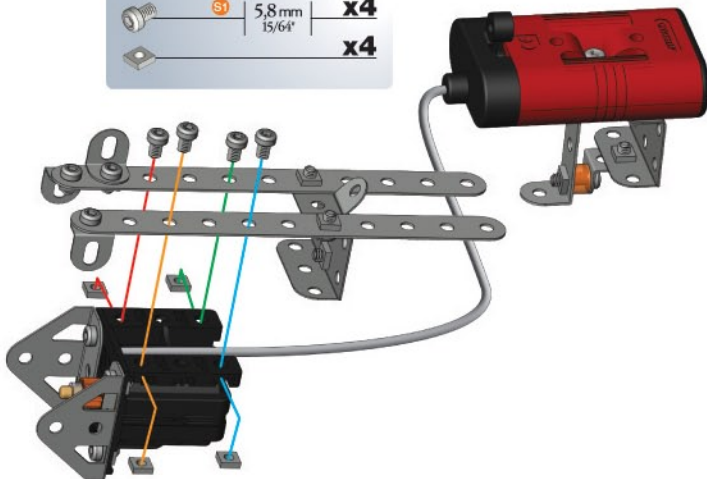

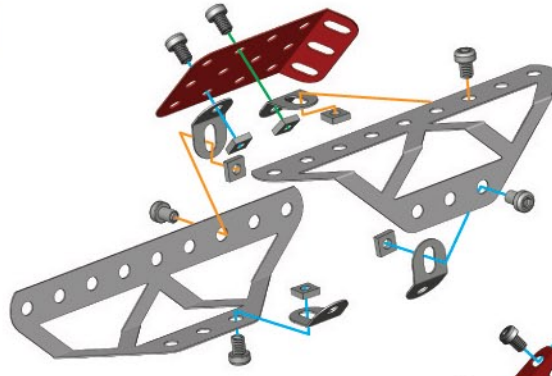
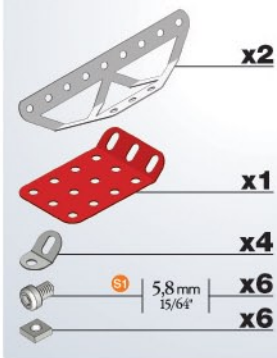
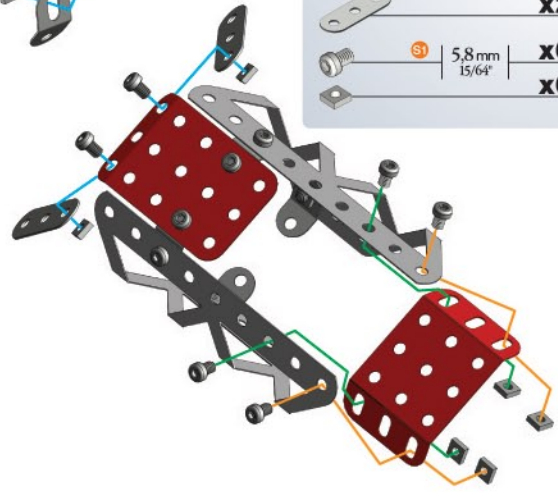
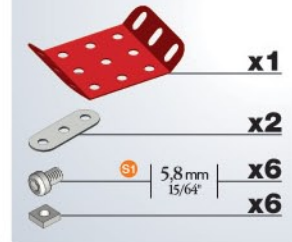
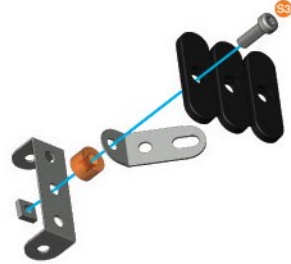
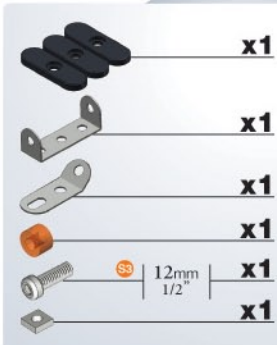
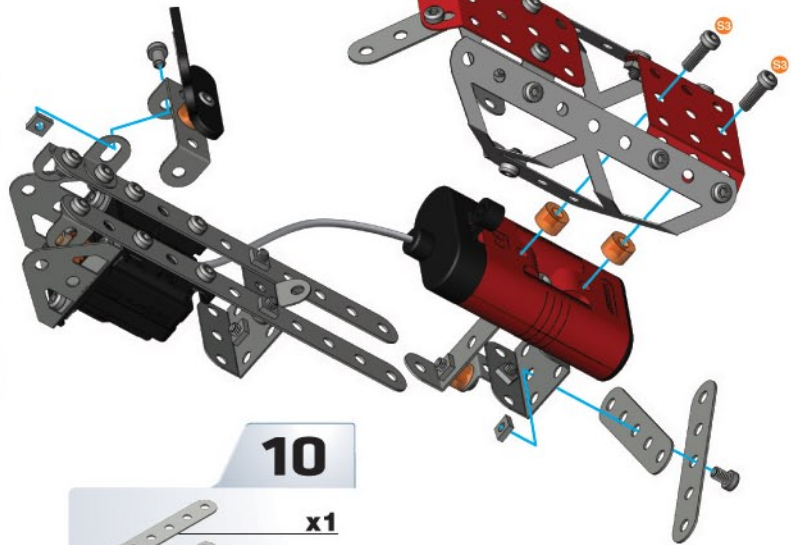
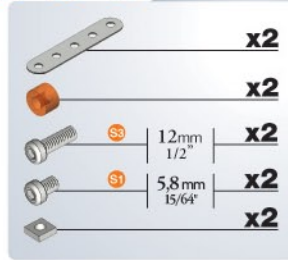
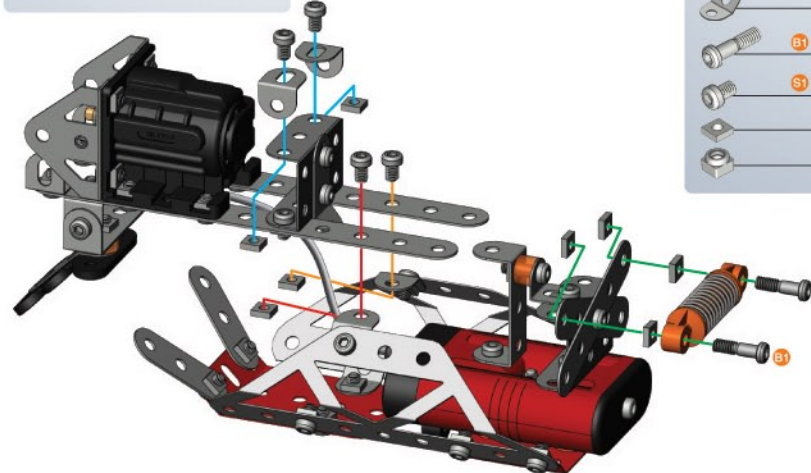
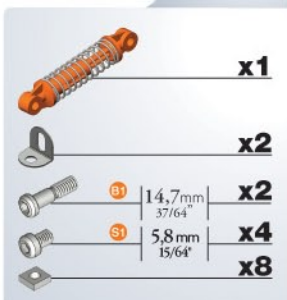
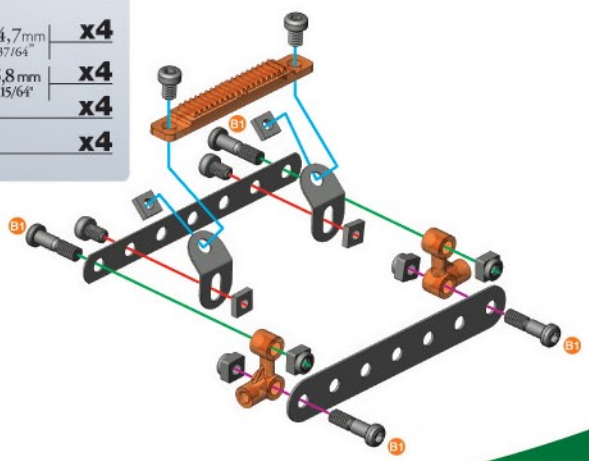



- (2) + (3) +**
-  **x4** | 5,8mm | 15/64"
 -  **x4**



5**6****7****8****9****10**

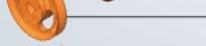

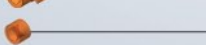
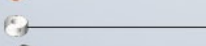
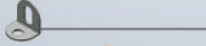



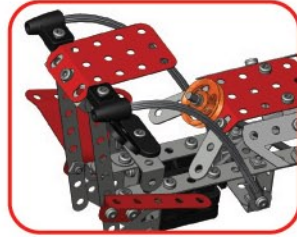
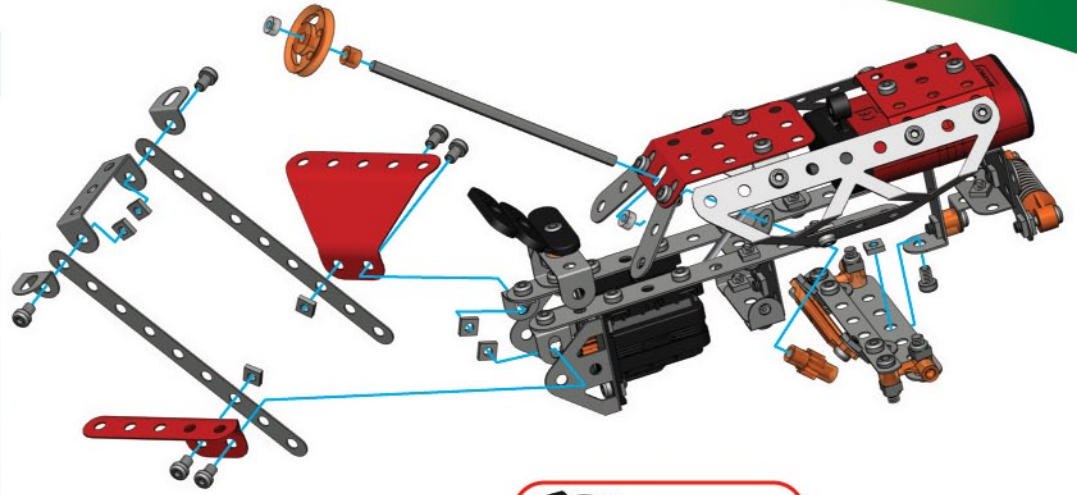

9 + 10 +

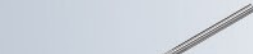
11

-  **x2**
-  **x1**
-  **x1**
-  **x2**
-  **x1**
-  **x1**
-  **x1**
-  **x2**
-  **x2**
-  **x7**
-  **x7**



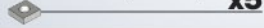



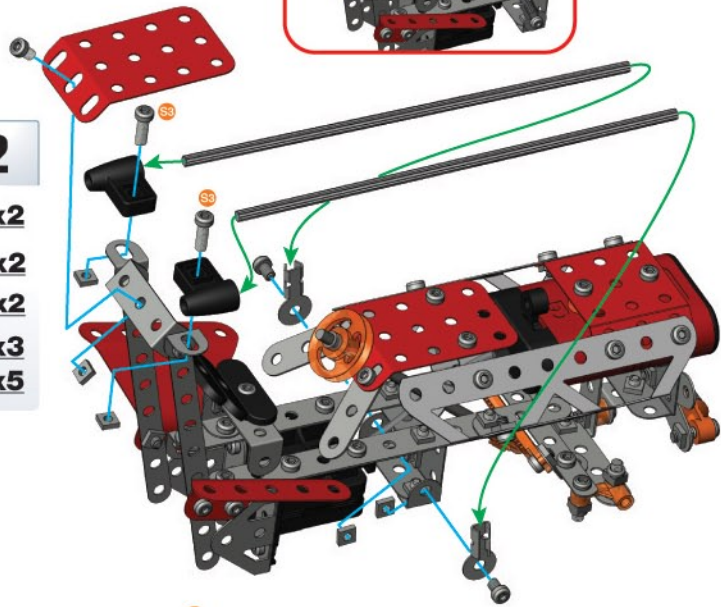





12

-  **x2**
-  **x2**
-  **x2**
-  **x2**
-  **x1**
-  **x2**
-  **x3**
-  **x5**







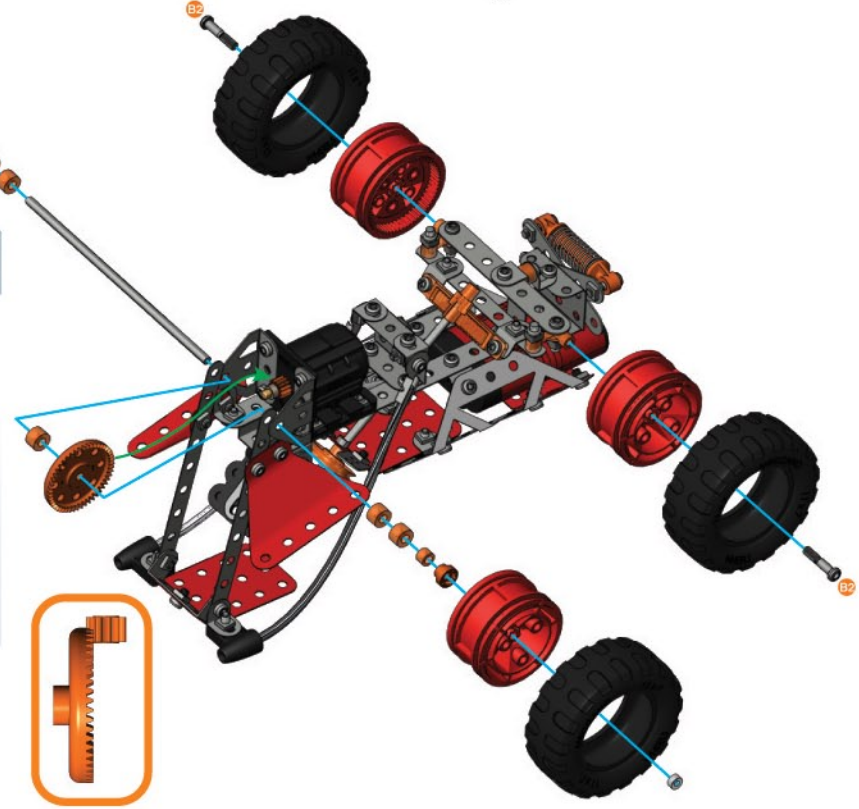





13

-  **x1**
-  **x1**
-  **x4**
-  **x4**
-  **x2**
-  **x5**
-  **x2**
-  **x2**
-  **x2**
-  **x2**











1

-  x1
-  x1
-  x2
-  x1
-  x2
-  x1
-  x1
-  x1
-  x9
-  x8





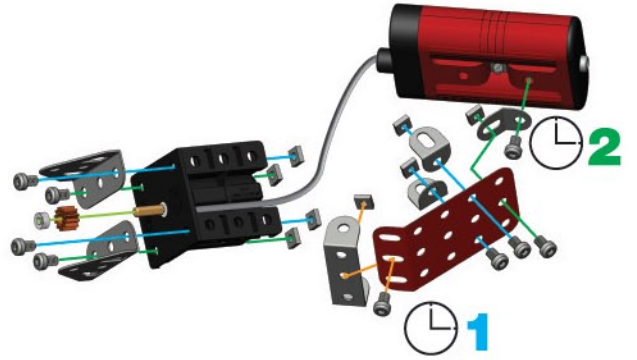

2

-  x1
-  x1
-  x4
-  19mm 3/4" x2
-  5,8mm 15/64" x2
-  x4







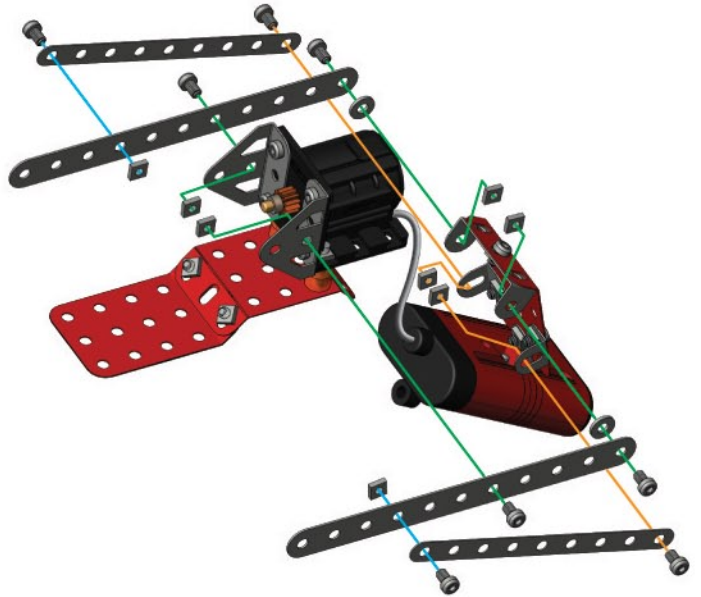







3

-  x2
-  x2
-  5,8mm 15/64" x8
-  x8
-  x2







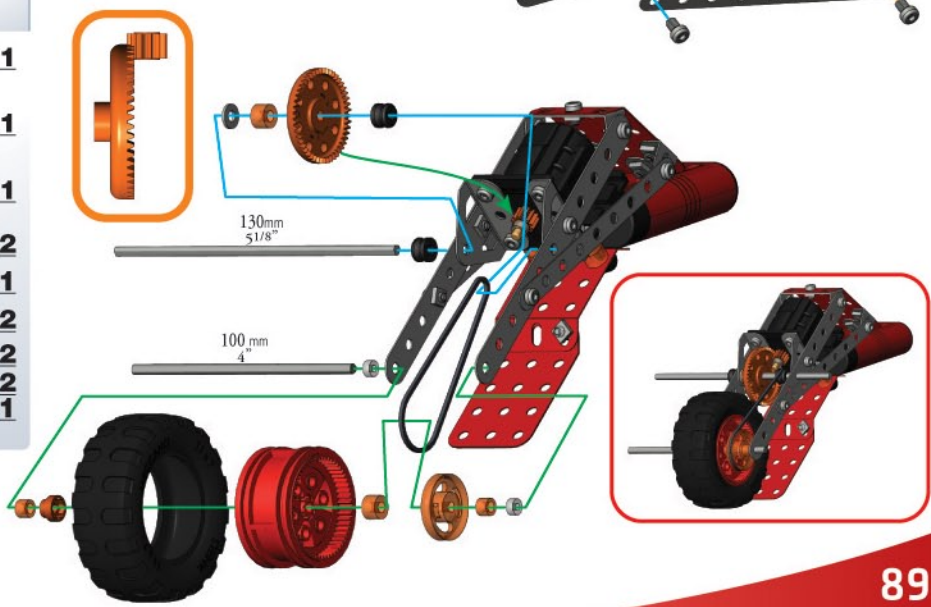

4

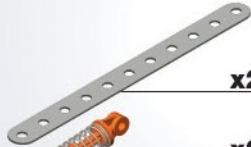
-  130mm 5 1/8" x1
-  100mm 4" x1
-  x1
-  x1
-  x1
-  x1
-  x1
-  x2
-  x1
-  x2
-  x2
-  x2
-  x1





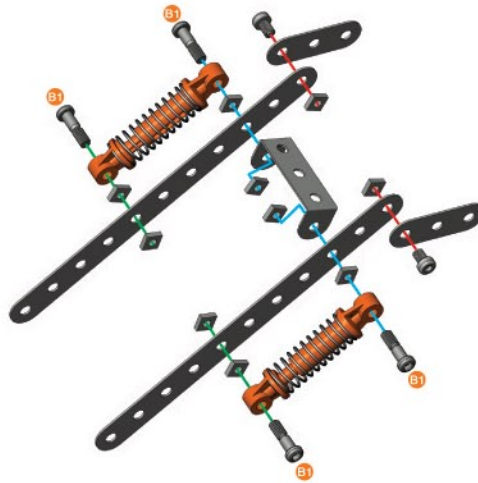

5

-  **x2**
-  **x2**
-  **x1**
-  **x2**
-  **x4**
-  **x2**
-  **x10**











6

-  **x1**
-  **x1**
-  **x2**
-  **x2**
-  **x1**
-  **x2**
-  **x2**
-  **x2**
-  **x1**





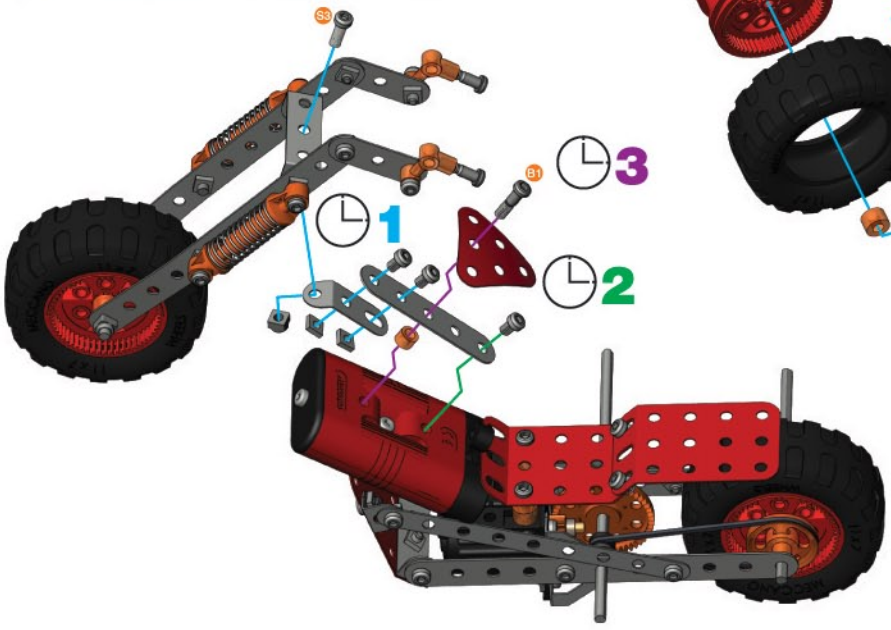
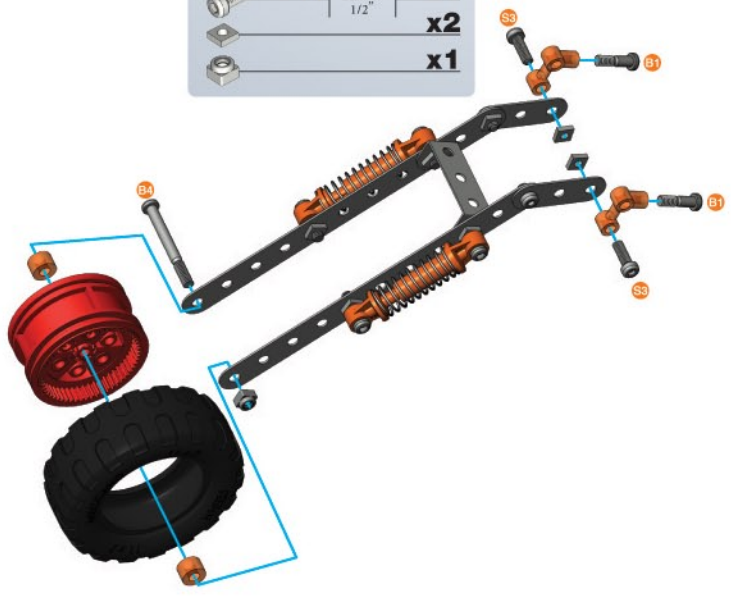

4+6+

7

-  **x1**
-  **x1**
-  **x1**
-  **x1**
-  **x1**
-  **x1**
-  **x3**
-  **x2**
-  **x1**





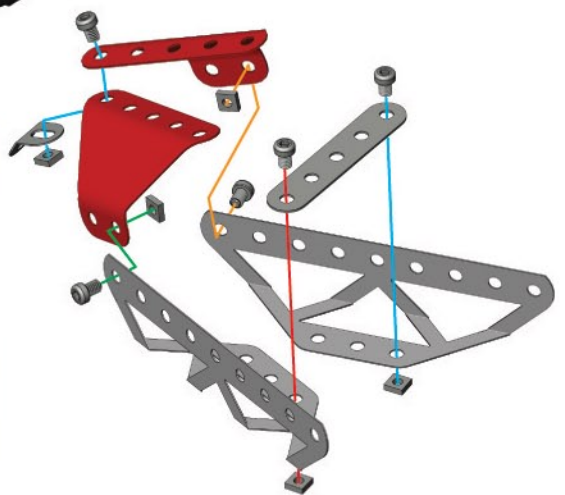

8





-  **x2**
-  **x2**
-  **x1**
-  **x1**
-  **x5**
-  **x5**

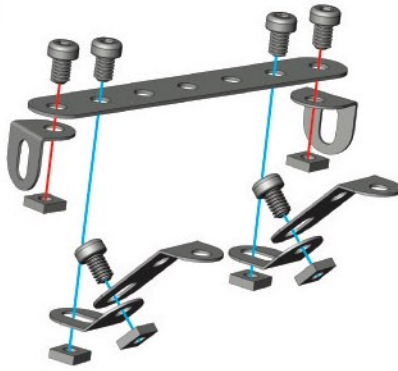

9

-  **x1**
-  **x2**
-  **x2**
-  **x2**
-  **x6**
-  **x6**

**10**

-  **x1**
-  **x2**
-  **x1**
-  **x2**
-  **x5**
-  **x5**

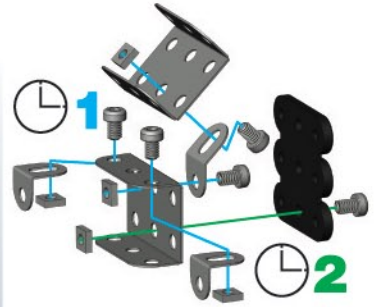
**8 + 9 + 10 +****11**

-  **x2**
-  **x1**
-  **x1**
-  **x2**
-  **x2**
-  **x2**
-  **x7**
-  **x9**

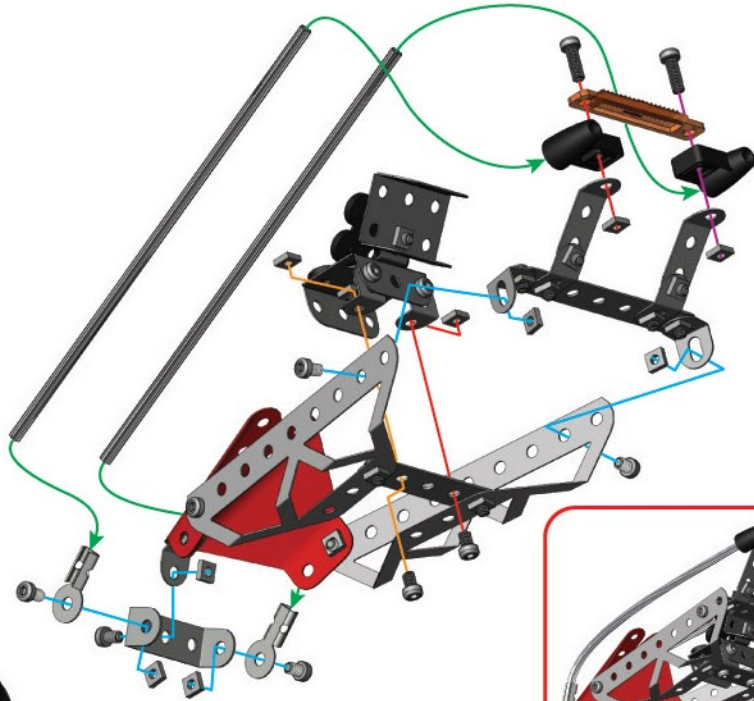
**7 + 11 +****12**

-  **x1**
-  **x1**
-  **x1**
-  **x1**
-  **x1**
-  **x1**
-  **x1**
-  **x2**





1

	x1		x1
	x1		x2
	x1		x1
	x1		x1
	x2		5,8mm 15/64" x8
			x7
			x1

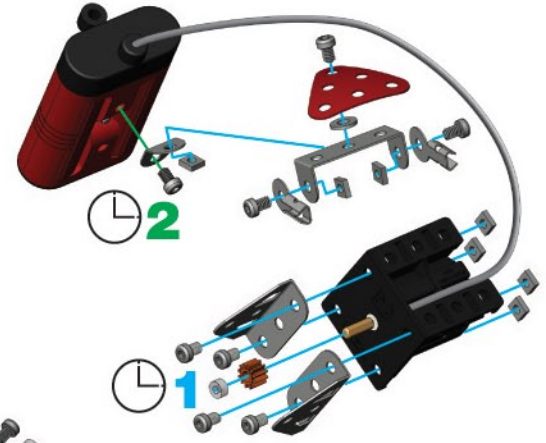

2

	x2
	130mm 5 1/8" x1
	x1
	x1
	x1
	x2
	5,8mm 15/64" x4
	x4
	x1

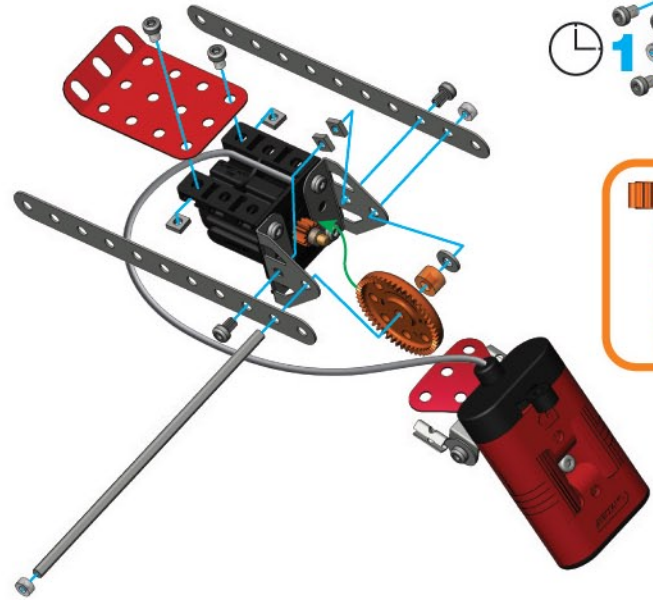

3

	x1
	x1
	x1
	x1
	12mm 1/2" x1
	5,8mm 15/64" x2
	x3

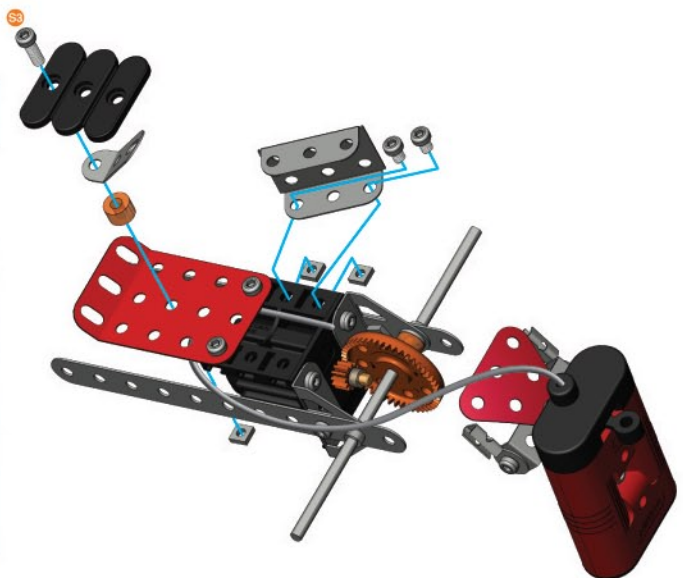

4

	x1
	x1
	x1
	x1
	x1
	x3
	x5
	x1

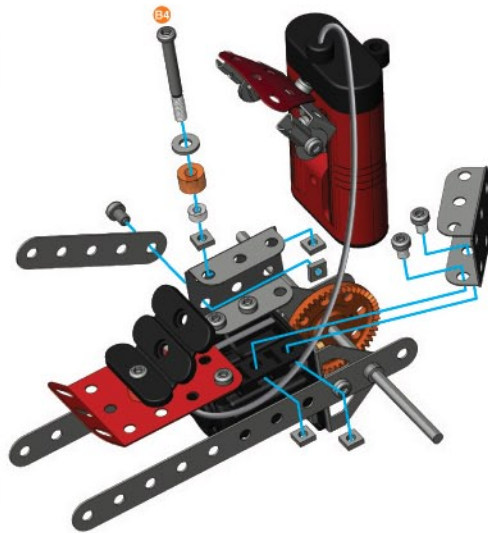

5

	x1
	x2
	x2
	x2
	x3
	x5

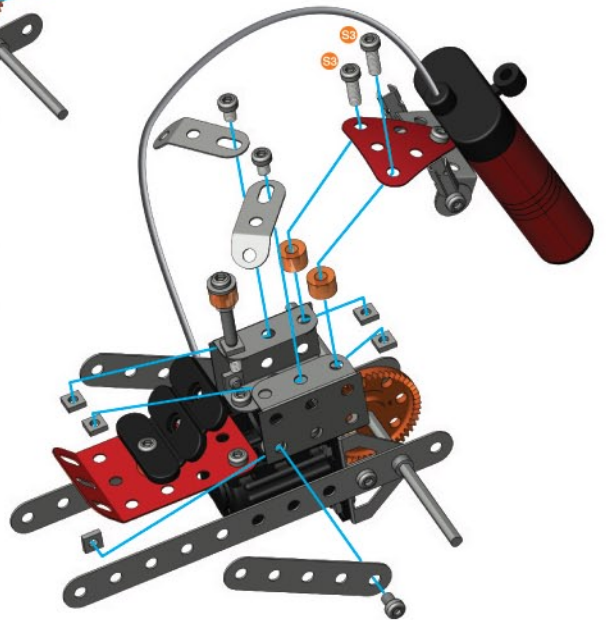

6

	x1
	x2
	x4
	x4

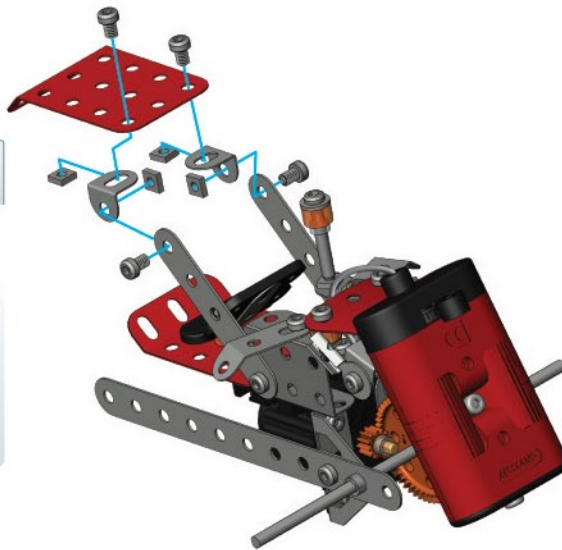





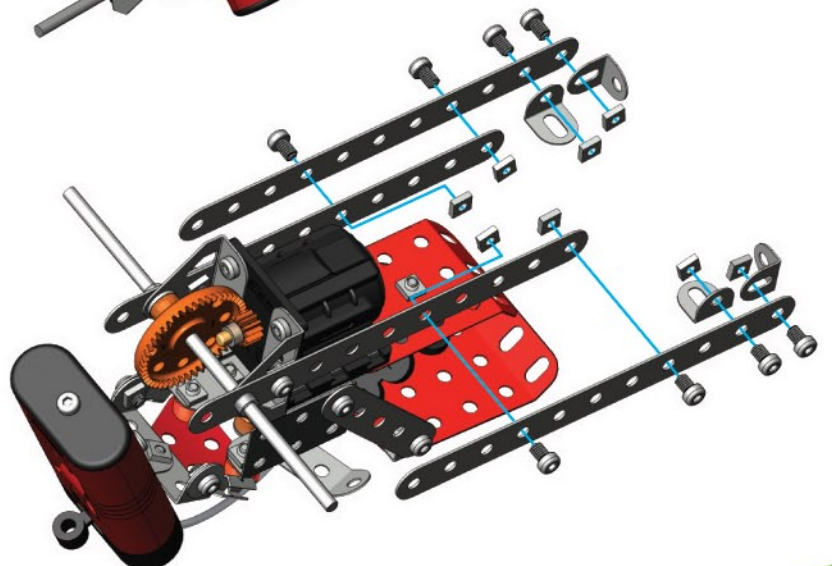

7

	x2
	x4
	x8
	x8







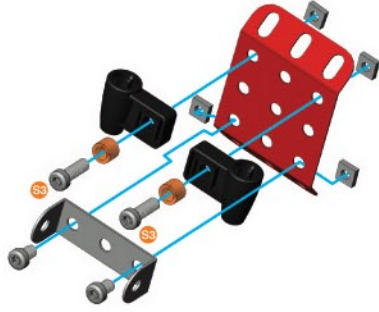



8

-  x1
-  x2
-  x1
-  x2
-  12mm 1/2" x2
-  5,8mm 15/64" x2
-  x4









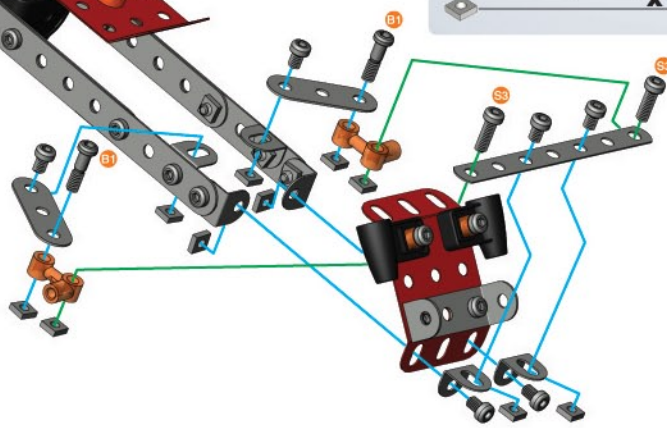

7+8+

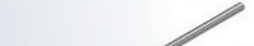
9

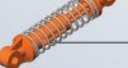
-  x1
-  x2
-  x2
-  x2
-  14,7mm 37/64" x2
-  12mm 1/2" x2
-  5,8mm 15/64" x6
-  x10







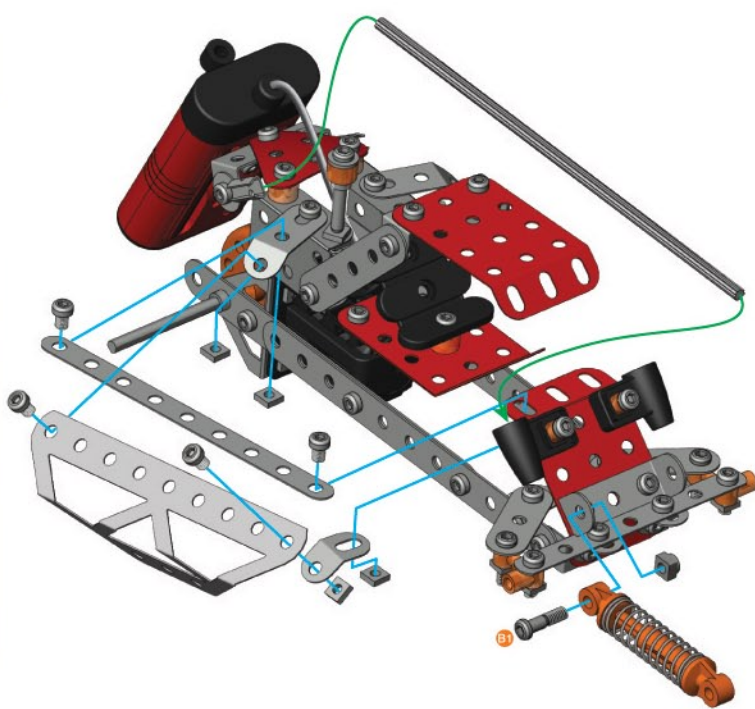

10

-  x1
-  x1
-  x1
-  x1
-  x1
-  14,7mm 37/64" x1
-  5,8mm 15/64" x4
-  x4
-  x1



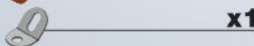

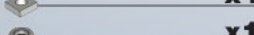
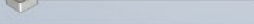

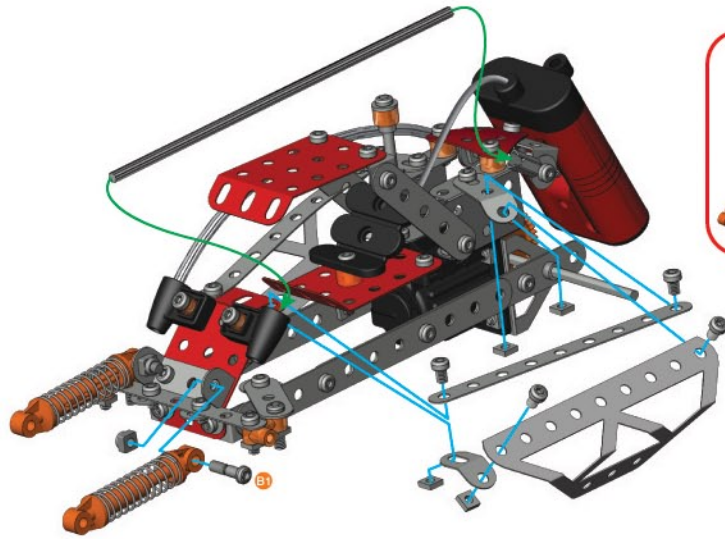
11

-  x1
-  x1
-  x1
-  x1
-  x1
-  14,7mm | 37/64" x1
-  5,8mm | 15/64" x4
-  x4
-  x1

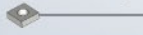

12

-  x2
-  x1
-  x1
-  5,8mm | 15/64" x4
-  x4

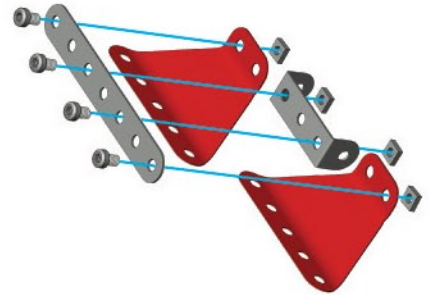

11 + 12 +

13

-  x4
-  x4
-  x2
-  x4
-  x2
-  x2
-  19mm | 3/4" x2
-  14,7mm | 37/64" x2
-  x2

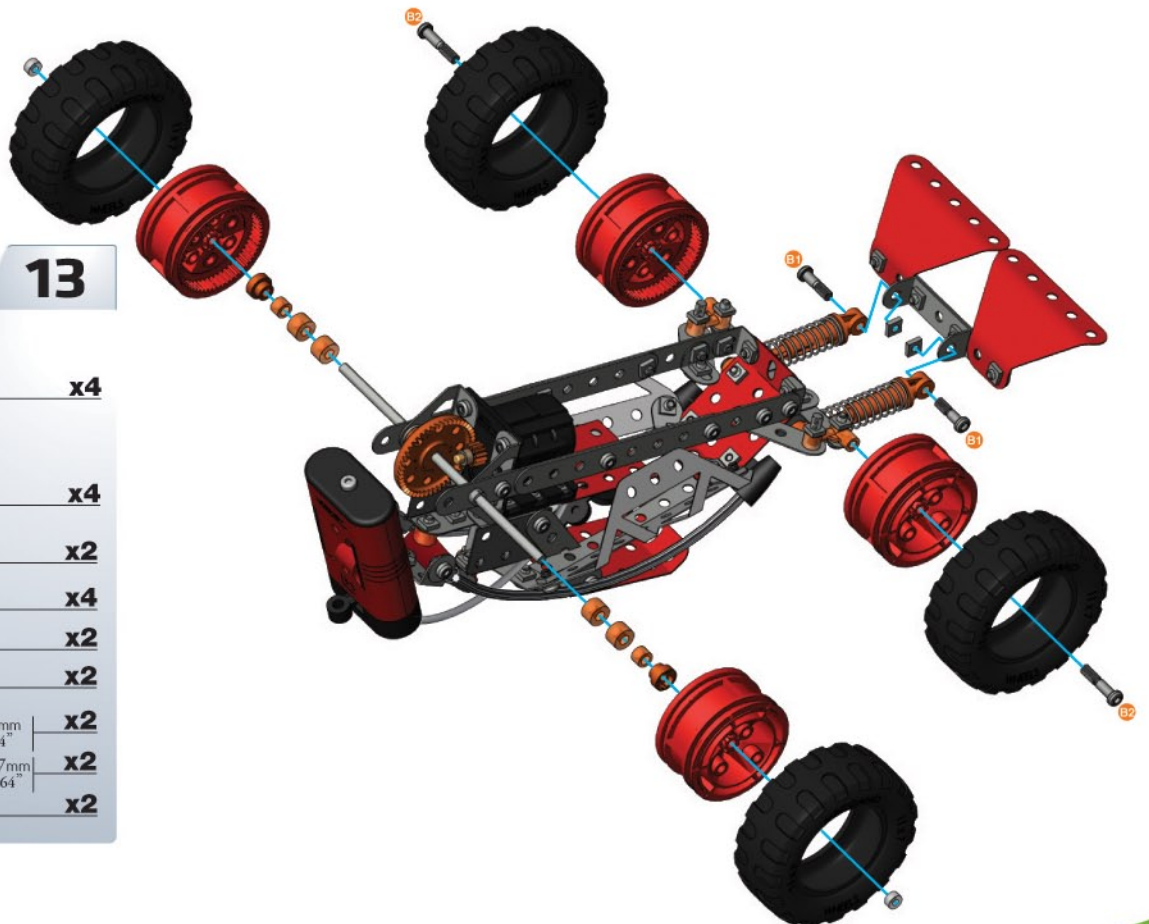

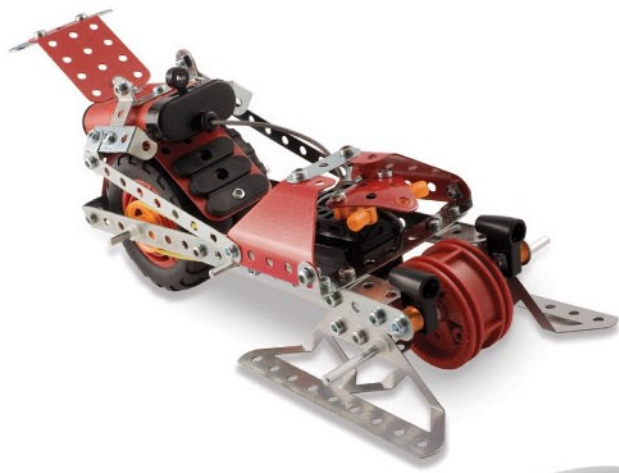

1

	x1		x1
	x1		x2
	x1		x1
	x1		x1
			x7
			x5

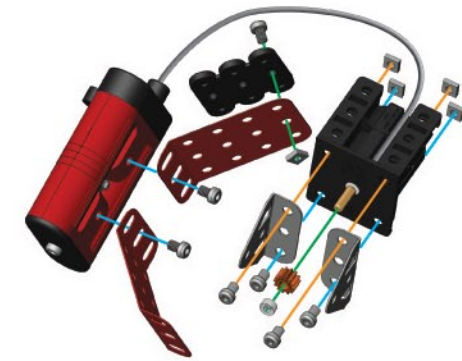

2

	x1
	x2
	x4
	x4

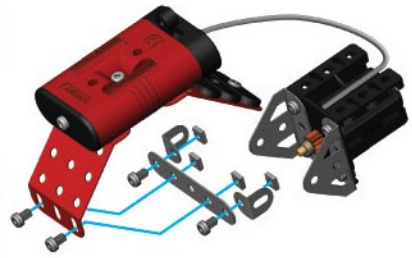

3

	x4		x4
			x2
			x4
			x6

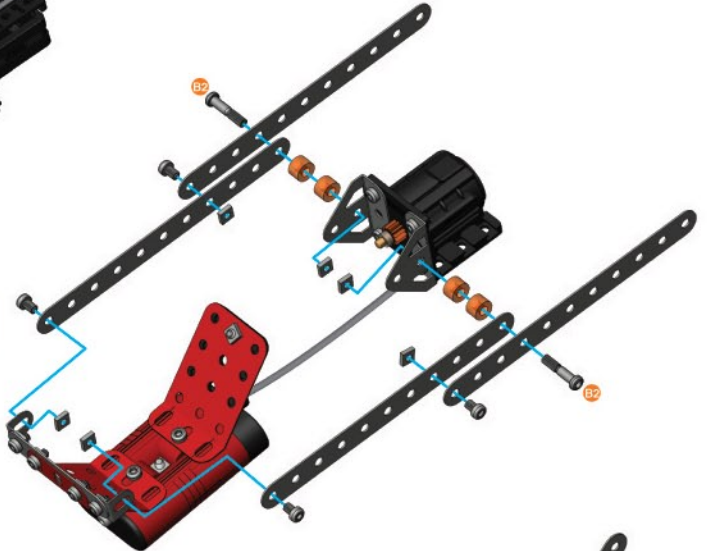



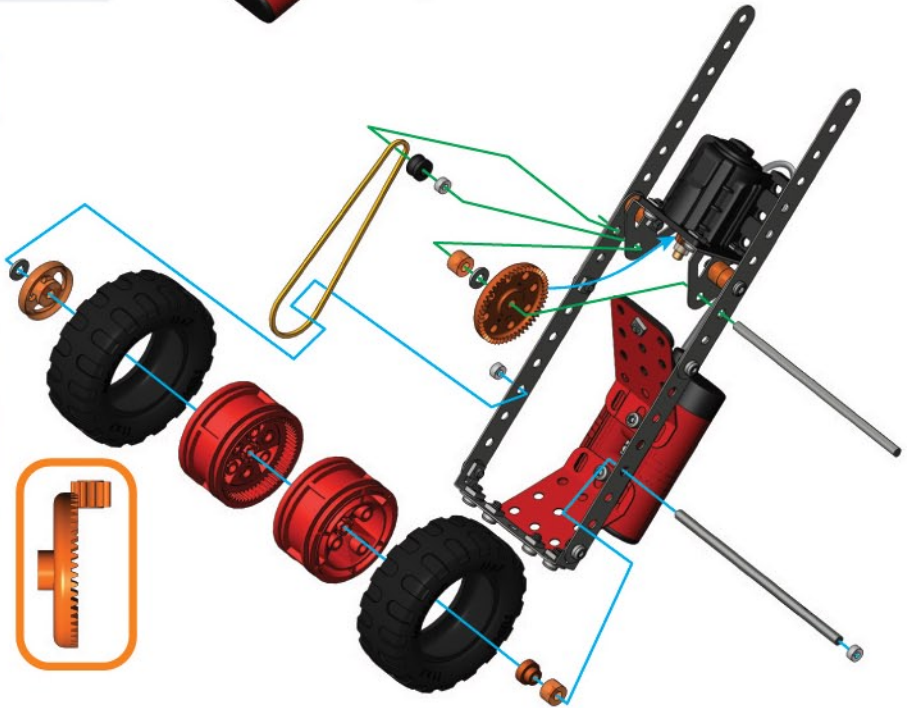

4





	x2		x1
	x2		x1
	x2		x1
	x1		x1
			x2
			x3
			x2



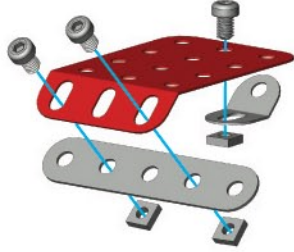



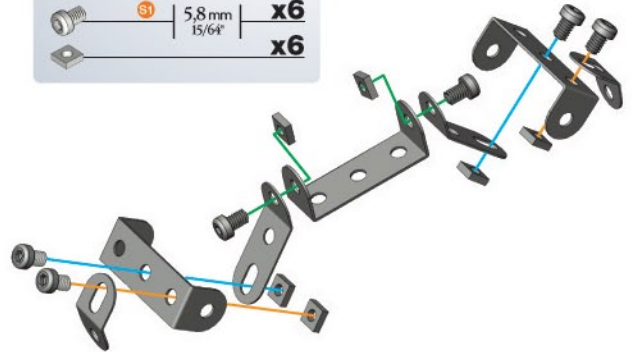

5

-  **x1**
-  **x1**
-  **x1**
-  **x3**
-  **x3**





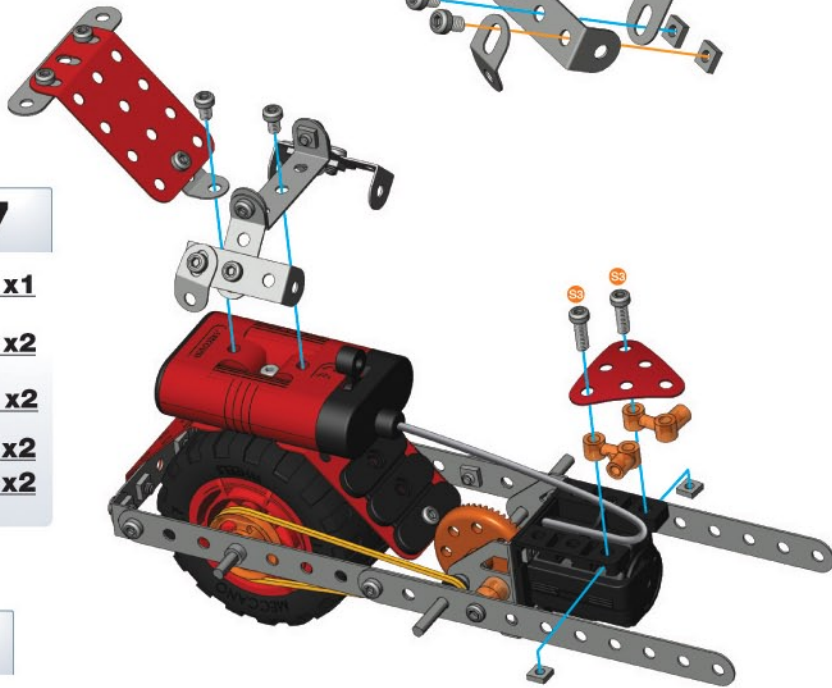

**6**

-  **x3**
-  **x2**
-  **x2**
-  **x6**
-  **x6**





**4 + 5 + 6 + 7****7**

-  **x1**
-  **x2**
-  **x2**
-  **x2**
-  **x2**

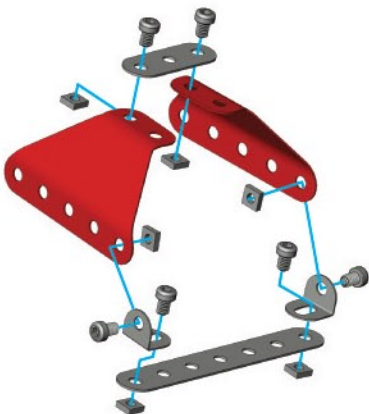
**8**

-  **x2**
-  **x1**
-  **x1**
-  **x2**
-  **x6**
-  **x6**

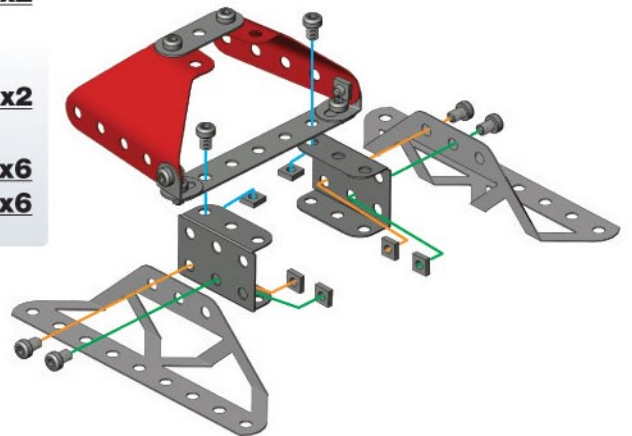

**9**

-  **x2**
-  **x2**
-  **x6**
-  **x6**





7 + 9 +

10

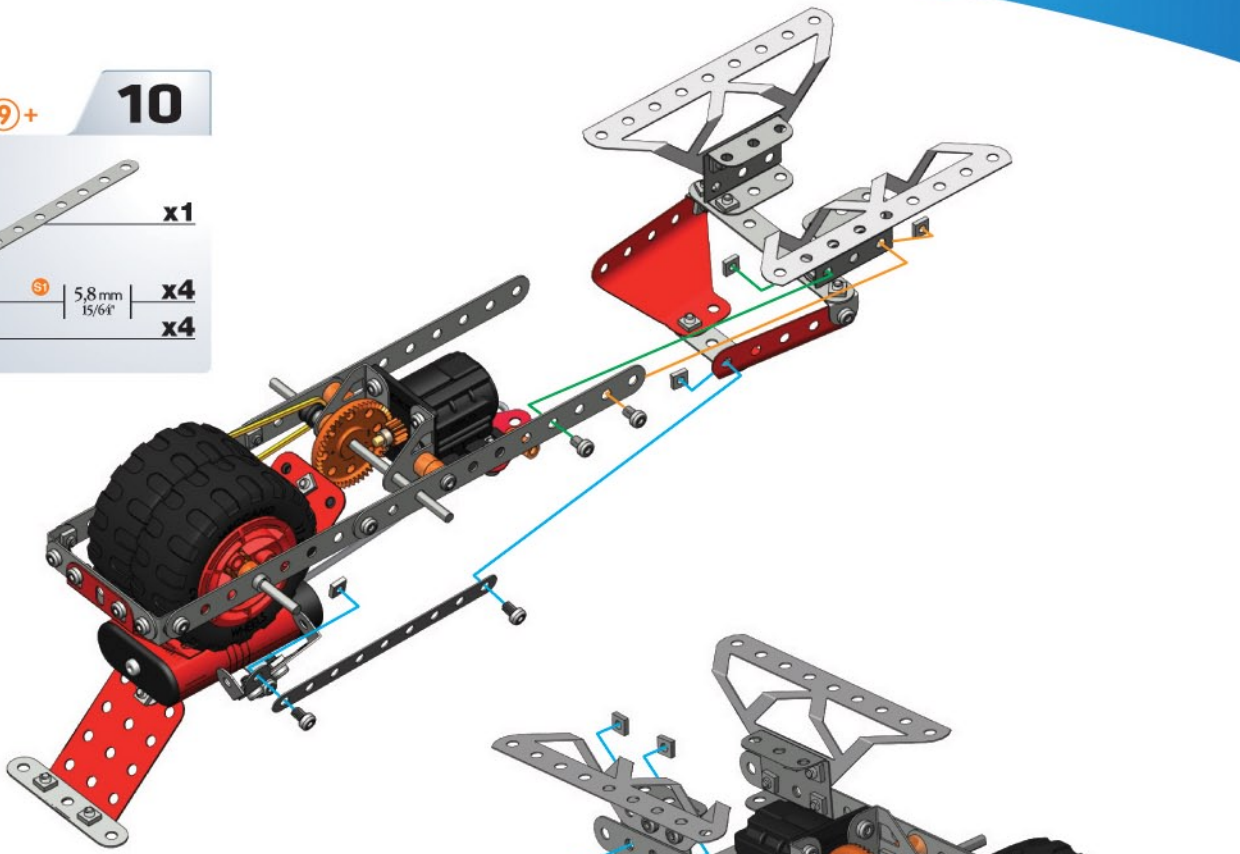
-  x1
-  x4
-  x4



11

-  x1
-  x4
-  x4

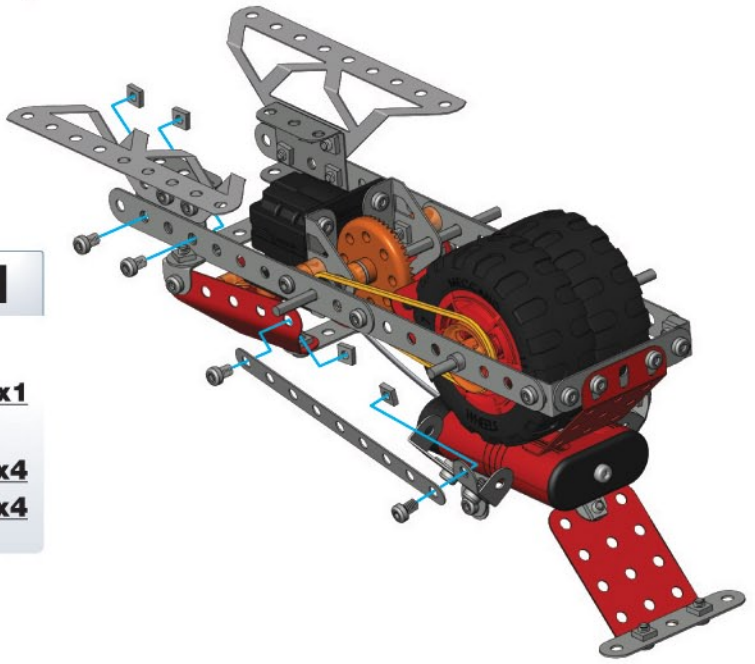

12

-  x1
-  x1
-  x2
-  x2
-  x3
-  x2
-  x2

