

MECCANO

BONUS

- 1**
- x1
 - x1
 - x1
 - x1
 - x1

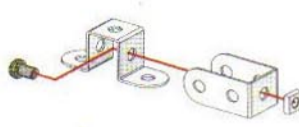

- 2**
- x1
 - x1
 - x2
 - x2

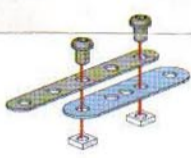

- 3**
- x1
 - x2
 - x2

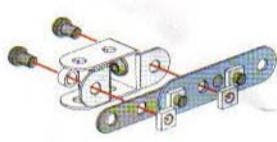

- 4**
- x1
 - x1
 - x1
 - x1



- 5**
- x1
 - x1
 - x1
 - x1

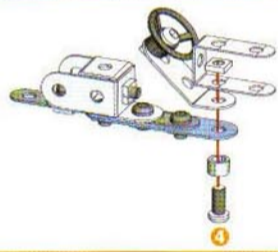

- 6**
- x1
 - x1
 - x1
 - x1
 - x1
 - x1

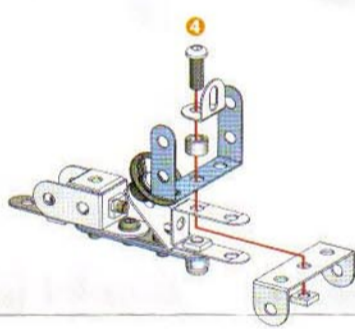

- 7**
- x1
 - x1
 - x1
 - x2
 - x2

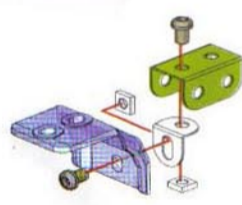

- 8**
- x1
 - x2
 - x3
 - x3

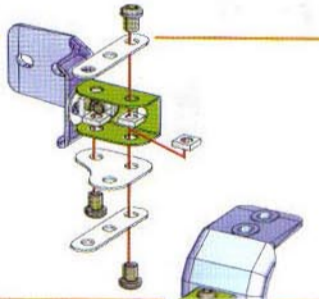

- 9**
- x2
 - x2

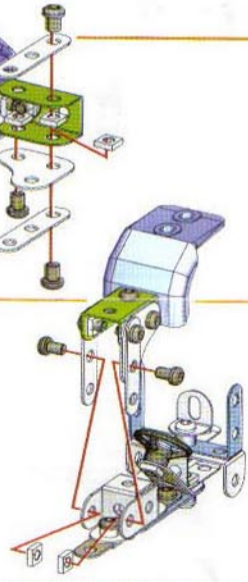

MECCANO®

1517

1517



1518



1519



BONUS



GB Many of the models and component parts are unique and original designs which are the property of MECCANO S.A. They are protected by national legislation on industrial designs. Infringements are liable throughout many countries. For detailed information, please contact MECCANO S.A. MECCANO S.A. accepts no responsibility for (1) failure to follow instructions, (2) use for any purpose other than specified in the instructions, (3) any alteration of any parts or components. MECCANO S.A. respects children's safety and models are tested by children.

F De nombreux modèles et pièces sont des créations originales, propriétés de MECCANO S.A. et sont protégés par les législations nationales sur les dessins et modèles, marques et/ou droits d'auteurs. Pour toute information, merci de contacter : MECCANO S.A. La responsabilité de MECCANO S.A. ne saurait être engagée en cas d'accident, survenu à la suite (1) d'un non respect des instructions de montage (2) d'une utilisation des pièces autre que celle précisée dans le notice (3) d'une altération ou de la modification des pièces. La société MECCANO s'engage sur la sécurité des enfants - ses modèles sont testés par des enfants.

D Zahlreiche Modelle und Teile sind Erfindungen und Eigentum der Firma MECCANO S.A. Sie sind durch italien Gesetze über Zeichnungen und Modelle sowie Warenzeichen und/oder Urheberrechte geschützt. Für zusätzliche Auskünfte wenden Sie sich bitte an: MECCANO S.A. Die Firma Meccano S.A. haftet nicht für (1) Nichtbefolgen der Bauanleitung, (2) Verwendung der Modelle zu anderen als in der Bauanleitung angegebenen Zwecken oder der (3) Änderung oder Modifikation der Teile einzelner Modelle. Alle Modelle der Firma Meccano S.A. wurden von Kindern getestet und entsprechen den Sicherheitsvorschriften.

I Numeri modelli e pezzi sono creazioni originali della MECCANO S.A. e sono protetti dalle legislazioni nazionali sui disegni e modelli, marchi e/o diritti d'autore. Per qualsiasi informazione, vi preghiamo di contattare MECCANO S.A. Meccano S.A. non si assume alcuna responsabilità in caso di incidenti dovuti a: (1) mancato rispetto delle istruzioni di montaggio, (2) uso improprio delle parti, (3) alterazione o modifica delle parti. La società MECCANO rispetta la sicurezza dei bambini e i suoi modelli vengono testati dai bambini stessi.

E Ni, nenasas modelos e pezas son creaciones orixinais, propiedades de MECCANO S.A. e están protexidas por leis legislativas nacionais en lo que concerne a: (1) non respectar as instrucións de montaxe, (2) uso incorrecto das pezas e (3) modificación das pezas. A sociedade MECCANO respalda a segurancia dos nenos e os seus modelos son testados por nenos.

R Vários modelos e peças são criações originais, propriedades de MECCANO S.A. e são protegidos pelas legislações nacionais relativas aos desenhos e modelos, marcas e/ou aos direitos de autor. Para qualquer informação, e favor contactar: MECCANO S.A. A Sociedade MECCANO S.A. não poderá ser responsabilizada pelos acidentes provocados. (1) pelo não cumprimento das instruções de montagem (2) pelo uso indevido das peças ou (3) pela modificação ou alteração das peças. A Sociedade MECCANO respeita a segurança dos crianças e os seus modelos foram testados por crianças.

S Många modeller och delar består av unika och original konstruktioner vilka är MECCANO S.A. egendom. Dessa modeller och delar är skyddade genom lagstiftning inom industriell konstruktion, varumärken och/eller upphovsrättigheter i ett flertal länder. För mer detaljerad information, vänligen kontakta MECCANO S.A. MECCANO S.A. åtar sig inte ansvar för (1) felaktig användning av delarna (2) användning av delarna till något annat ändamål än det som anges i de monteringsinstruktionerna (3) ändring av delarna. För säkerhets skull testas MECCANO S.A. modeller av barn.

FIN Monetit mallit ja osat ovat MECCANO S.A:n omistamia aivan alkuperäisten suunnitelmien. Ne ovat kansainvälisellä tasolla suojattuja tavaramerkkejä, tekijänoikeuksia ja patentteja. Pyytämme otamaan huomioon MECCANO S.A:n vastuun osien käyttöä koskevista kysymyksistä. MECCANO S.A. ei vastaa eikä kiitä muista kuin virallisista ohjeista annetuista tiedoista. (1) virheellinen valmistusohjeiden noudattaminen, (2) mallien käyttö muihin kuin ohjeissa määriteltyihin tarkoituksiin, (3) osien muuttaminen tai korjaaminen. MECCANO S.A. huolehtii lasten turvallisuudesta: kaikki osat testataan lasten avulla.

DK Vore mange modeller og dele er originale konstruktioner og vares af MECCANO S.A. Tegningerne, modeller, handelsmærker og oplysninger er lovbeskyttede i flere lande. Yderligere oplysninger kan fås hos MECCANO S.A. MECCANO S.A. påtager sig ethvert ansvar, såfremt det er sket under forudsætning af (1) at monteringsvejledningen er blevet overholdt, (2) at delene er blevet brugt til andre formål, end dem der er beskrevet i betegnelsesvejledningen, (3) eller at delene er blevet beskadiget eller ændret. MECCANO S.A. overholder sikkerhedsreglerne for børn. Alle modeller testes af børn.

NL Veel modellen en onderdelen zijn originele ontwerpen en eigendom van MECCANO S.A. en worden beschermd door de nationale wetgevingen op tekeningen en modellen, merken en/of auteursrechten. Voor informatie gelieve contact op te nemen met MECCANO S.A. De aansprakelijkheid van MECCANO S.A. is beperkt tot geval van onjuiste voorschriften uit het niet naleven van de montage-instructies (1), of het gebruik van andere onderdelen dan die zoals vermeld in de handleiding (2) of (3) het veranderen of modificeren van de onderdelen (3). De firma MECCANO aanvaardt de veiligheid van de kinderen en acht: de modellen zijn door kinderen getest.

GR Πολλά μοντέλα και μέρη είναι πρωτότυπα σχέδια, ιδιοκτησία της MECCANO S.A. και προστατεύονται από τις εθνικές νομοθεσίες για τα σχέδια, τα εμπορικά σήματα και/ή δικαιώματα πνευματικής ιδιοκτησίας. Για περισσότερες πληροφορίες, παρακαλούμε επικοινωνήστε με τη MECCANO S.A. Η εταιρεία MECCANO S.A. δεν φέρει ευθύνη για (1) μη συμμόρφωση με τις οδηγίες συναρμολόγησης, (2) χρήση των μερών για σκοπούς διαφορετικούς από αυτούς που αναφέρονται στις οδηγίες, (3) αλλαγές ή τροποποιήσεις των μερών. Η εταιρεία MECCANO S.A. διασφαλίζει την ασφάλεια των παιδιών. Όλα τα μοντέλα της MECCANO S.A. δοκιμάζονται από παιδιά.

JPN 多くのモデルと部品は、本社のオリジナル設計で、MECCANO S.A.の著作権と特許で保護されています。また、多くの国で商標、著作権、特許などの権利を保護されています。MECCANO S.A.は、(1)組み立て指示に従わず、(2)指示された用途以外の用途に部品を使用し、(3)部品を改造または変更することによる事故を、MECCANO S.A.は責任を負いません。MECCANO S.A.は、子供の安全を確保するために、すべてのモデルが子供によってテストされています。

© MECCANO and MECCANO MOTION SYSTEM are exclusive trademarks of MECCANO S.A. © 1999 MECCANO S.A.

Made in France by:
Fabrique de France, par
Mecho en France

MECCANO

363, avenue de Saint Euphrasy - F 62100 CALAIS

Service Clientèle
MECCANO FRANCE et BENELUX
Casella Paris 9412
Avenue Guy Prud'homme
92033 CASSELARY MALABRY CEDEX - FRANCE
Tel: 01 41 97 94 96

Customer Service
MECCANO TOYS LTD
Bobby Voss Centre
10, Bally Voss Passage
LONDON - ENGLAND W4 9PH
Tel: 020 8942 3888

Infocontact Service
MECCANO DEUTSCHLAND GMBH
Max-Planck-Str. 21 B
30856 HILDE - GERMANY
Mobile: 0 5 20 1 100 36 12

<http://www.meccano.com>

Inc. CACHÉ - 6810 Birmingham - FRANCE

631517102001

7

9



10

- x2
- x2
- 5,8 mm 15/64" x2

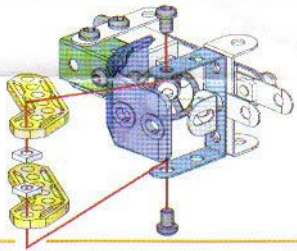

11

- x1
- x1
- x1



12

- x1
- x1
- 5,8 mm 15/64" x1

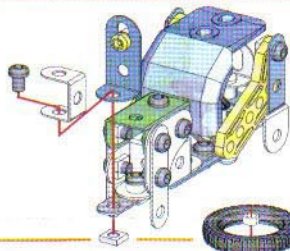

13

- 60 mm 2 3/8" x1
- x2
- x2
- x2
- x2

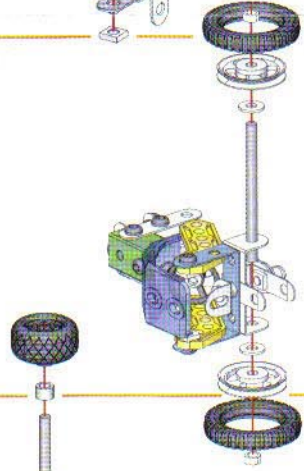

14

- 60 mm 2 3/8" x1
- x2
- x2

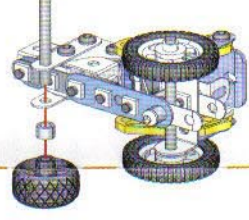

15

- x1
- x1
- x1
- x2
- x1
- 9,5 mm 3/8" x1

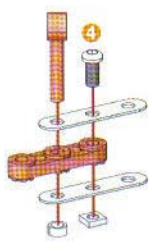

16

- x1
- x1
- 12 mm 1/2" x1

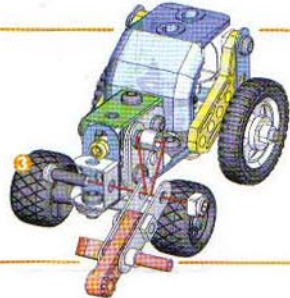

17

- x1
- x1
- x1
- x2
- x2
- 12 mm 1/2" x2

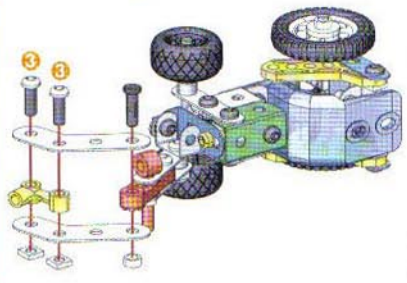

18

25



MECCANO®

1518



1517



1518



1519



BONUS



GB Many of the models and component parts are unique and original designs which are the property of MECCANO S.A. They are protected by national legislation as industrial designs, trademarks and/or copyright in many countries. For detailed information, please contact MECCANO S.A. Meccano S.A. accepts no responsibility for: (i) failure to follow instructions; (ii) use for any purpose other than as specified in the instructions; (iii) any alteration of any parts or components. MECCANO S.A. respects children's safety. All models are tested by children.

F De nombreux modèles et pièces sont des créations originales, propriété de MECCANO S.A. et sont protégées par les législations nationales ou les droits de modèles, marques et/ou droits d'auteurs. Pour toute information, merci de contacter MECCANO S.A. La responsabilité de MECCANO S.A. ne saurait être engagée en cas d'accident survenu à la suite: (i) du non respect des instructions de montage; (ii) d'une utilisation des pièces autre que celle proposée dans la notice; (iii) d'une altération ou de la modification des pièces. Le société MECCANO respecte la sécurité des enfants - ses modèles sont testés par des enfants.

D Zahlreiche Modelle und Teile sind Erfindungen und Eigentum der Firma MECCANO S.A. Sie sind durch Urrechts-Gesetze über Zeichnungen und Modelle sowie Warenzeichen und/oder Urheberrechte geschützt. Für zusätzliche Auskünfte wenden Sie sich bitte an: MECCANO S.A. Die Firma Meccano S.A. trägt nicht für Unfälle, die aus der: (i) Nichtbeachtung der Bauanleitung, der: (ii) Verwendung anderer als in der Bauanleitung angegebenen Teile oder der: (iii) Änderung oder Modifikation der Teile resultieren. Alle Modelle der Firma Meccano S.A. werden von Kindern getestet und entsprechen den Sicherheitsnormen.

I Numerosi modelli e pezzi sono creazioni originali della MECCANO S.A. e sono protetti dalle legislazioni nazionali sui disegni e modelli, marchi e diritti d'autore. Per qualsiasi informazione, vogliate prendersi contatto con: MECCANO S.A. Meccano S.A. declina ogni responsabilità: (i) in caso d'incidenti sopravvenuti in seguito di un non rispetto delle istruzioni di montaggio; (ii) utilizzo di pezzi per funzioni diverse da quelle previste nel manuale; (iii) alterazione o modifica di pezzi. La società MECCANO rispetta la sicurezza dei bambini i suoi modelli vengono testati da bambini stessi.

E Numeros modelos e peças são criações originais, propriedades da MECCANO S.A. e são protegidos por leis legislativas nacionais relativas ao design e marcas e/ou direitos de autor. Para qualquer informação, e favor contactar: MECCANO S.A. A Sociedade MECCANO S.A. não poderá ser responsabilizada pelos acidentes provocados: (i) pela falta de cumprimento das instruções de montagem; (ii) pelo uso indevido das peças ou (iii) pela modificação ou alteração das peças. A Sociedade MECCANO respeita a segurança das crianças: os seus modelos foram testados por crianças.

P Varios modelos e piezas são criações originais, propriedades da MECCANO S.A. e são protegidos pelas legislações nacionais relativas aos desenhos e marcas, e/ou aos direitos de autor. Para qualquer informação, e favor contactar: MECCANO S.A. A Sociedade MECCANO S.A. não poderá ser responsabilizada pelos acidentes provocados: (i) pela falta de cumprimento das instruções de montagem; (ii) pelo uso indevido das peças ou (iii) pela modificação ou alteração das peças. A Sociedade MECCANO respeita a segurança das crianças: os seus modelos foram testados por crianças.

S Många modeller och delar består av unika och originala konstruktioner vilken är MECCANO S.A. egendom. Dessa modeller och delar är skyddade genom lagstiftning såsom industri konstruktion, varumärken och/eller upphovsrättigheter i ett flertal länder. För mer detaljerad information, var vänlig och kontakta MECCANO S.A. MECCANO S.A. åtar sig inte ansvar, inbegripet av skador, för: (i) att man inte följer monteringsinstruktionerna; (ii) för missbruk av delar; (iii) för ändring av delar. Företaget MECCANO S.A. respekterar barns säkerhet. Alla modeller testas av barn.

FIN Uusien mallien ja osien ositt MECCANO S.A. on omnia alttia oivasta alkuperäisestä suunnitelmasta. Ne ovat kansainvälisillä laeilla suojattuja tekijäoikeuksilla, tavaramerkillä ja/tai kauppatunnusmerkillä. Pyydämme ottamaan yhteyden MECCANO S.A. näin hankkia lisätietoja. MECCANO S.A. ei vastaa mitään vasta tapahtuneista vaurioista tai onnettomuuksista: (i) ohjeiden väärinkäytön vuoksi; (ii) osien muuttamisesta tai muokkauksesta; (iii) osien muuttamisesta tai korjauksista käytetty MECCANO S.A:n osien käyttäminen luvatta. Kaikki mallit testataan lapsilla.

DK Vore mange modeller og dele er originale konstruktioner og ejes af MECCANO S.A. Tegninge, modeller, varemærker og/eller ophavsrettede i flere lande. Vi beder om oplysninger kan få fra MECCANO S.A. MECCANO S.A. frastpør sig effektivt ansvar, sålænge det er det ulovlige forbrug af: (i) at man ikke følger de anvisninger; (ii) at delene er blevet brugt til andre formål, end dem der er beskrevet i betegningsvejledningen; (iii) eller at delene er blevet modificeret eller ændret. MECCANO S.A. respekterer børns sikkerhed. Alle modeller testes af børn.

NL Veel modellen en onderdelen zijn origineel ontworpen en eigendom van MECCANO S.A. in een aantal landen. Deze modellen en onderdelen zijn beschermd door de nationale wetgevingen op bescherming van modellen, merken en/of auteursrechten. Voor informatie, gelieve contact op te nemen met MECCANO S.A. De verantwoordelijkheid van MECCANO S.A. is beperkt: (i) in het geval van onjuiste aanwijzingen; (ii) het niet naleven van de montage-instructies; (iii) het gebruik van andere onderdelen dan die bedoeld worden in de handleiding; (iv) of het veranderen of modificeren van de onderdelen; (v) de klinken MECCANO S.A. niet de veiligheid van de kinderen in acht: de modellen zijn door kinderen getest.

GR Πολλά από τα μοντέλα και τα εξαρτήματα είναι πρωτότυπα, ιδιοκτησία της MECCANO S.A. και προστατεύονται από το εθνικό νομοθετικό σύστημα ως σχέδια, εμπορικά σήματα και/ή δικαιώματα πνευματικής ιδιοκτησίας. Για περισσότερες πληροφορίες, παρακαλούμε επικοινωνήστε με τη MECCANO S.A. Η MECCANO S.A. δεν ευθύνεται για: (i) μη συμμόρφωση με τις οδηγίες συναρμολόγησης; (ii) χρήση των εξαρτημάτων για άλλους σκοπούς από αυτούς που προτείνονται στις οδηγίες; (iii) αλλαγές ή τροποποιήσεις στα μέρη. Η εταιρεία MECCANO S.A. σεβάζεται την ασφάλεια των παιδιών. Όλα τα μοντέλα δοκιμάζονται από παιδιά.

JPN 多くのモデルと部品は、MECCANO S.A.の独自の設計によるものであり、MECCANO S.A.の財産です。これらのモデルと部品は、特許法、商標法、著作権法などによって保護されています。MECCANO S.A.は、(i) 組み立て指示に従わず、(ii) 部品を指示された用途以外の用途で使用し、(iii) 部品を改造または変更することによる事故や故障について、MECCANO S.A.に責任を負いません。MECCANO S.A.は、子供たちの安全を尊重しています。すべてのモデルは子供によってテストされています。

MECCANO and MECCANO MOTION SYSTEM are exclusive trademarks of MECCANO S.A. © 1999 MECCANO S.A.

1







10



9



17

18

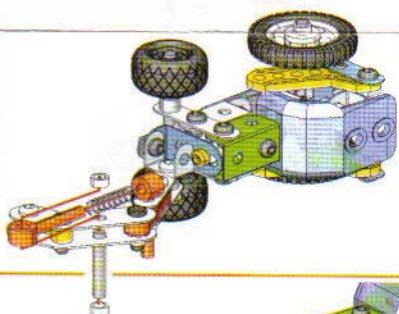
-  x1
-  25 mm x1
-  x2
-  x1



19

-  x1
-  x1
-  5,8 mm x1

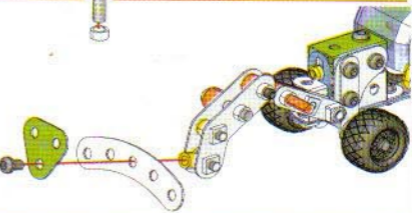

20

-  x1
-  x1
-  x1
-  x2
-  x1
-  x1
-  x2
-  12 mm x2

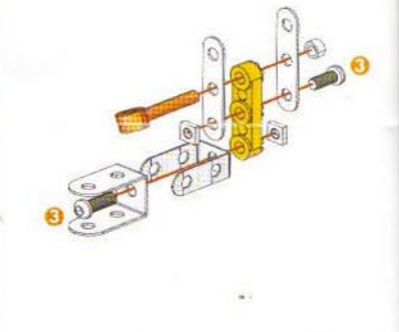







21

-  32 mm x1
-  x2





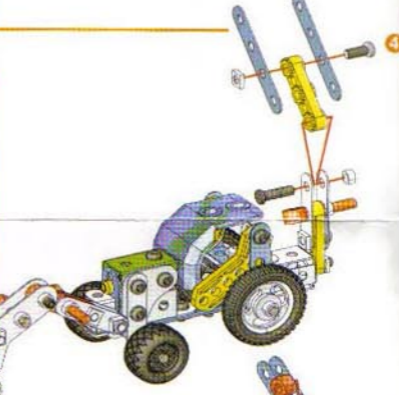

22

-  x2
-  x1
-  x1
-  x1
-  x1
-  9,5 mm x1





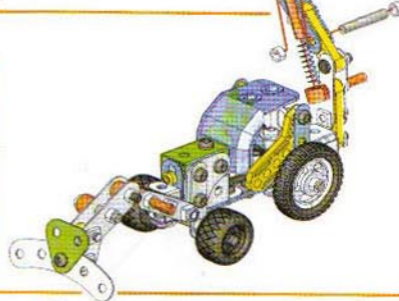

23

-  25 mm x1
-  x1
-  x1
-  x2



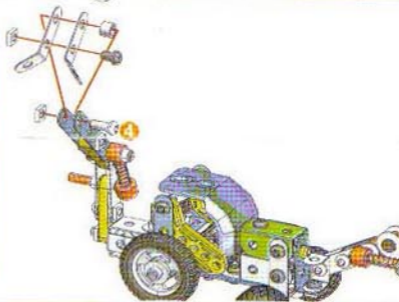

24

-  x2
-  x1
-  x2
-  9,5 mm x1
-  5,8 mm x1



25

-  x2
-  x2
-  5,8 mm x2

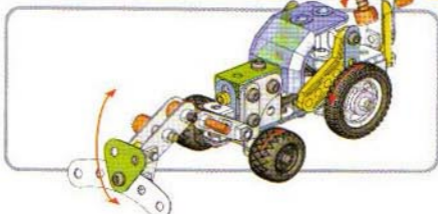
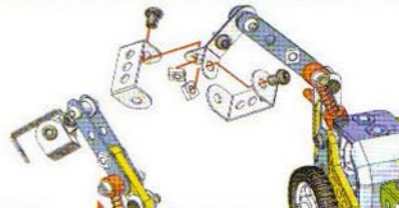

MECCANO®

1519

1517



1518

1519



BONUS



- GB** Many of the models and component parts are unique and original designs which are the property of MECCANO S.A. They are protected by national legislation as industrial designs, trademarks and/or copyright. In many countries. For detailed information, please contact MECCANO S.A. Meccano S.A. accepts no responsibility for: (1) failure to follow instructions; (2) use for any purpose other than as specified in the instructions; (3) any alteration of any parts or components. MECCANO S.A. respects children's safety; all models are tested by children.
- F** De nombreux modèles et pièces sont créations originales, propriétés de MECCANO S.A. et sont protégés par les législations nationales sur les dessins et modèles, marques ou droits d'auteurs. Pour toute information, merci de contacter MECCANO S.A. La responsabilité de MECCANO S.A. ne saurait être engagée en cas d'accident survenu à la suite (1) du non respect des instructions de montage (2) d'une utilisation des pièces autre que celle proposée dans le notice (3) d'une altération ou de la modification des pièces. La société MECCANO respecte la sécurité des enfants; ses modèles sont testés par des enfants.
- D** Zahlreiche Modelle und Teile sind Erfindungen und Eigentum der Firma MECCANO S.A. Sie sind durch inland-Gesetze über Zeichnungen und Modelle sowie Markenrechten und/oder Urheberrechte geschützt. Für zusätzliche Auskünfte wenden Sie sich bitte an: MECCANO S.A. Die Firma MECCANO S.A. haftet nicht für Unfälle, die aus der (1) Nichtbefolgung der Bauanleitung, der (2) Verwendung anderer als in der Bauanleitung angegebenen Teile oder der (3) Änderung oder Modifikation der Teile resultieren. Alle Modelle der Firma MECCANO S.A. wurden von Kindern getestet und entsprechen den Sicherheitsanforderungen.
- I** Numerosi modelli e pezzi sono creazioni originali della MECCANO S.A. e sono protetti dalle legislazioni nazionali sui disegni e modelli, marchi e diritti d'autore. Per qualsiasi informazione, vogliate prendere contatto con MECCANO S.A. Meccano S.A. declina ogni responsabilità in caso di incidenti sopravvenuti in seguito (1) al non rispetto delle istruzioni di montaggio (2) all'uso di pezzi per funzioni diverse da quelle previste nel manuale (3) all'alterazione o modifica dei pezzi. La società MECCANO rispetta la sicurezza dei bambini; i suoi modelli vengono testati dai bambini stessi.
- E** Numerosos modelos y piezas son creaciones originales, propiedades de MECCANO S.A. y están protegidos por las legislaciones nacionales en lo que concierne a los dibujos y modelos, marcas y derechos de autor. Para cualquier información, por favor ponerse en contacto con MECCANO S.A. MECCANO S.A. cancela de responsabilidad en caso de accidente ocurrido (1) al incumplimiento de las instrucciones de montaje (2) una utilización de las piezas diferente a la que se indica en las instrucciones (3) una alteración o modificación de las piezas. La sociedad MECCANO respeta la seguridad de los niños; sus modelos están probados por niños.
- P** Vários modelos e peças são criações originais, propriedades da MECCANO S.A. e são protegidos pelas legislações nacionais relativas aos desenhos e modelos, marcas e/ou aos direitos de autor. Para qualquer informação, é favor contactar MECCANO S.A. A Sociedade MECCANO S.A. não poderá ser responsabilizada pelos acidentes provocados (1) pela falta de cumprimento das instruções de montagem (2) pelo uso indevido das peças ou (3) pela modificação ou alteração das peças. A Sociedade MECCANO respeita a segurança das crianças; os seus modelos foram testados por crianças.
- S** Många modeller och delar är unika och originalt utformade vilken är MECCANO S.A. egendom. Dessa modeller och delar är skyddade genom äggt rättsligt skydd såsom industriell formgivning, varumärken och/eller upphovsrättigheter i ett eller flera länder. För mer detaljerad information, var vänlig och kontakta MECCANO S.A. MECCANO S.A. åtar sig inte ansvar för: (1) misslyckande att följa monteringsanvisningarna (2) användning av delarna för ändamål som inte är avsett för dem som står i anvisningen (3) en förändring eller förändring av delarna. För åtgärder MECCANO respekterar barns säkerhet; modellerna har testats av barn.
- FIN** Usemme mallit ja osat ovat MECCANO S.A:n omistamia olevia alkuperäisiä suunnitelmia. Ne ovat suojattuja sella laeilla, joiden nojalla mallit, tavaramerkit ja/tai tekijänoikeudet. Pyytämme ottamaan yhteyden MECCANO S.A. hen kaska asaan kysyttyä lisätietoa. MECCANO S.A. ei vastaa eikä suostu vastuuta yksittäisten käyttäjien tekemistä: (1) ohjeiden vastaiseen kokoonpanuun; (2) osien tai osien väärinkäyttöön; (3) osien muuttamiseen tai muuttamiseen käyttö MECCANO-yhtenä huoketta osien luovutusta. (3)99) ovat lastenrauhetta mallien.
- DK** Vore mange modeller og dele er originale fremstillinger og/eller er MECCANO S.A. Tegninger, modeller, varemærkesmerker og/eller er beskyttede i et eller flere land. Yderligere oplysninger kan fås hos MECCANO S.A. MECCANO S.A. fastholder sig til sin ansvar, såfremt det er sket ulovligt brug af (1) af monteringsinstruktionerne ikke er blevet overholdt, (2) af delene er blevet brugt til andre formål, end dem der er beskrevet i brugningsvejledningen, (3) eller af delene er blevet beskadiget eller ændret. MECCANO respekterer sikkerhedsforholdene for børn. Alle modeller testes af børn.
- NL** Veel modellen en onderdelen zijn originele ontwerpen en eigendommen van MECCANO S.A. en worden beschermd door de nationale wetgeving op het gebied van modellen, merken en/of auteursrechten. Voor informatie gelieve contact op te nemen met MECCANO S.A. De verantwoordelijkheid van MECCANO S.A. is niet gebonden in geval van ongebruikt voortzetten of het niet naleven van de montage-instructies (1), of het gebruik van andere onderdelen dan die zijn bedoeld in de handleiding (2) of het veranderen of modificeren van de onderdelen (3). De firma MECCANO neemt de veiligheid van de kinderen in acht; de modellen zijn door kinderen getest.
- GR** Πολλά από τα μοντέλα και τα εξαρτήματα είναι μοναδικά, ιδιαιτέρως της MECCANO S.A. και προστατεύονται από τις εθνικές νομοθεσίες σχετικά με τα σχέδια, τα εμπορικά σήματα και/ή δικαιώματα πνευματικής ιδιοκτησίας. Για περισσότερες πληροφορίες, παρακαλούμε επικοινωνήστε με τη MECCANO S.A. Η MECCANO S.A. δε φέρει ευθύνη για: (1) μη τήρηση των οδηγιών συναρμολόγησης (2) χρήση των εξαρτημάτων για σκοπούς διαφορετικούς από αυτούς που προβλέπονται στις οδηγίες (3) αλλαγή ή τροποποίηση των εξαρτημάτων. Η εταιρεία MECCANO S.A. σεβάζεται την ασφάλεια των παιδιών; τα μοντέλα της δοκιμάζονται από παιδιά.
- JPN** MECCANO S.A.の多くのモデルと部品は、独自の設計であり、MECCANO S.A.の所有物です。これらは、特許法、商標法、著作権法などによって保護されています。MECCANO S.A.は、(1)組み立て説明書に従わずに組み立てられたり、(2)説明書に記載されていない用途で使用されたり、(3)説明書に記載されていない方法で変更されたりした場合に発生する事故や怪我等について責任を負いません。MECCANO S.A.は、子供の安全を確保するために、すべてのモデルが子供によってテストされています。

© MECCANO and MECCANO MOTOR SYSTEM are exclusive trademarks of MECCANO S.A. © 1996 MECCANO S.A.