

Instructions
Notice de montage
Bauanleitung
Istruzioni di montaggio
Instrucciones de montaje
Instruções de montagem
Monteringsanvisning
Kokoamisohje
Monterings instruktioner
Montagehandleiding
Οδηγίες συναρμολόγησης
組立説明書

RENAULT **F1** Team

RENAULT
toys

de 8 ans à +



#0508



8+



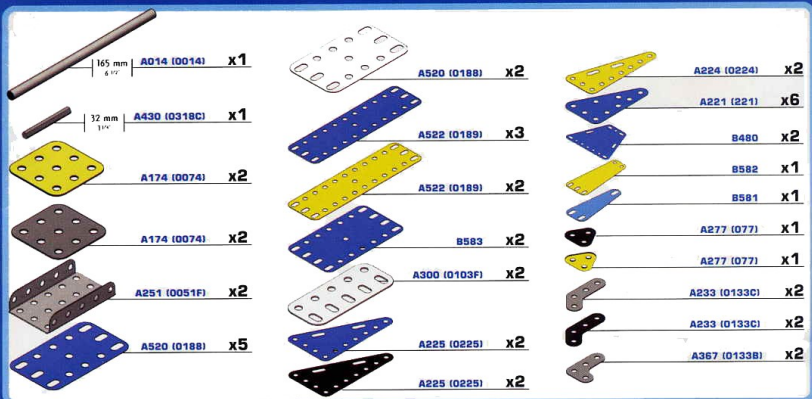

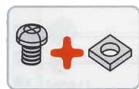
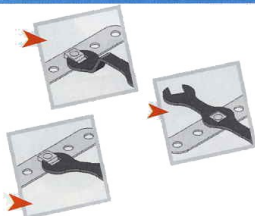
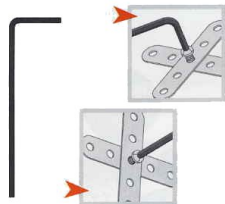

1



2



3

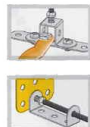

1



2

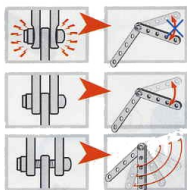

1:1

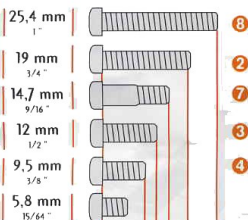

Scale
Échelle
Maßstab
Scala

Escala
Schaal
Escala
Skala



Mittakaava
Målestok
Κλίμακα
スケール

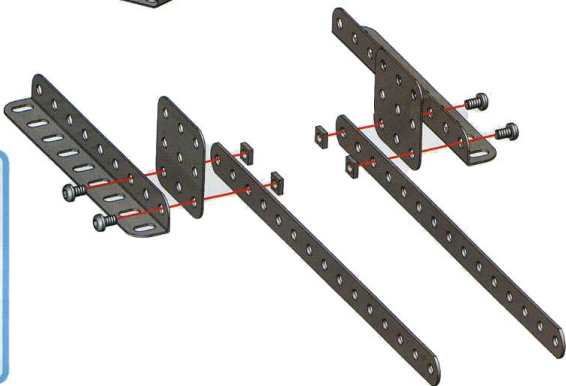
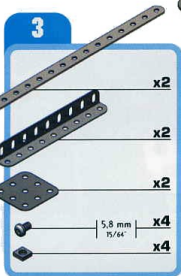
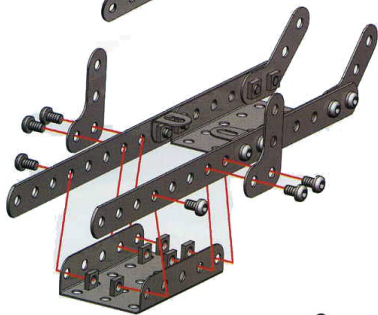
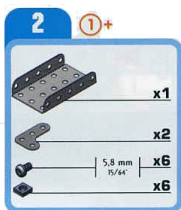
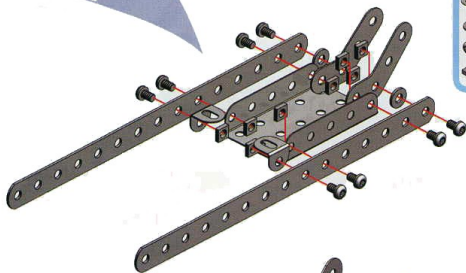
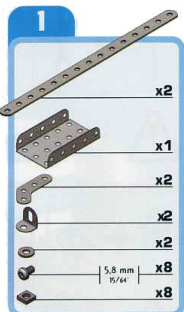







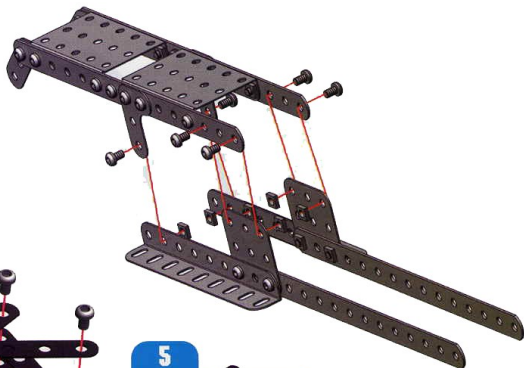
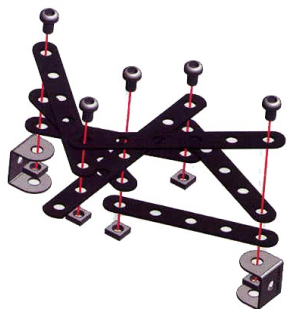

4

②+③+

	5,8 mm	x6
	19/44	x6





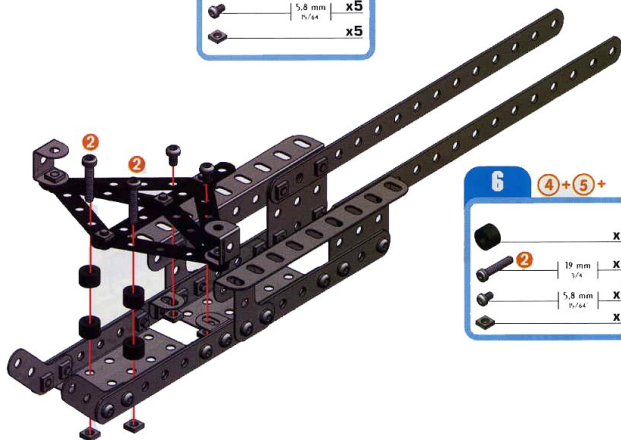

5

	x1	
	x2	
	x4	
	x2	
	5,8 mm	x5
	19/44	x5









6

④+⑤+

	x4		
	②	19 mm	x2
		1/4	
		5,8 mm	x2
		19/44	x4

7

	x1		
	x2		
	x4		
	x1		
	x1		
		5,8 mm	x4
		19/44	x4

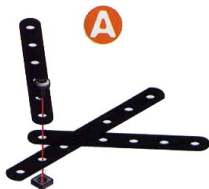



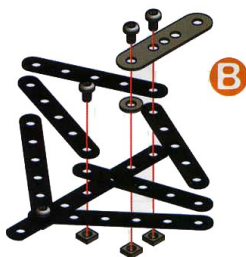

A



B







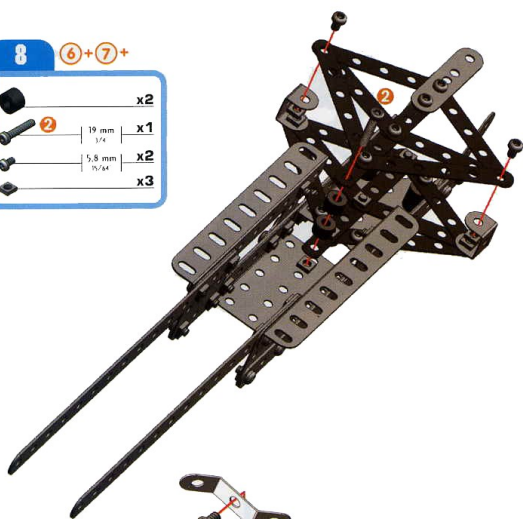

8

6+7+

	x2
	x1
	x2
	x3







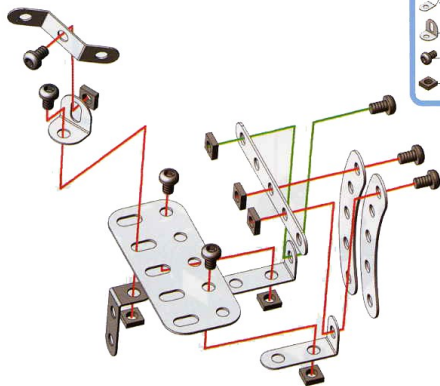



9

	x1
	x1
	x2
	x2
	x1
	x1
	x1
	x7
	x7



10

	x1
	x1
	x2
	x2
	x1
	x1
	x1
	x7
	x7

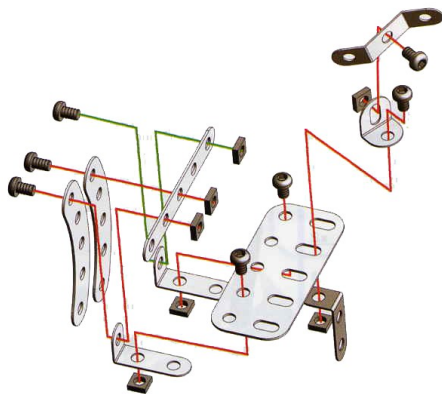

11

9 + 10 +

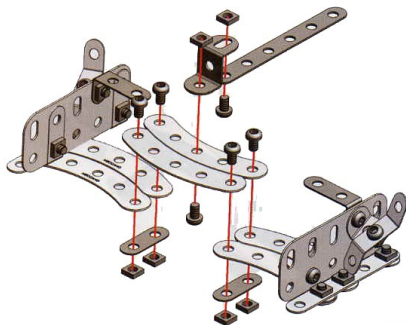
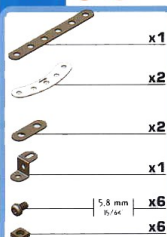

12

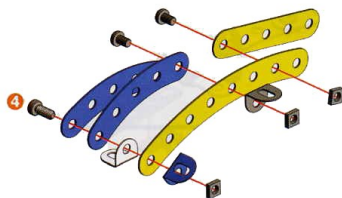
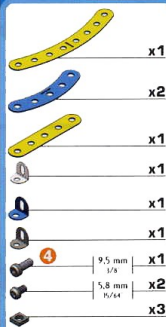

13

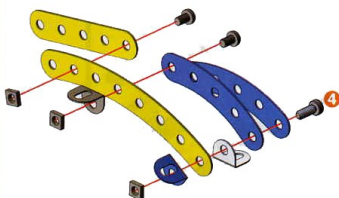
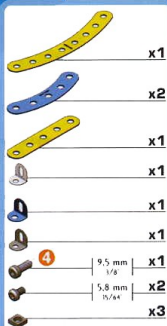

14

12 + 13 +

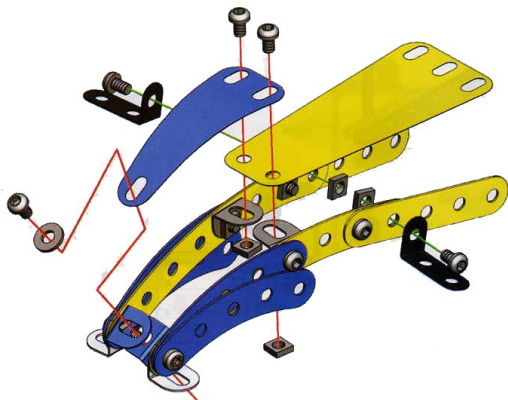
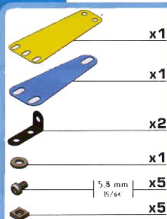

15

(11)+(14)+

	5,8 mm	x2
	16/64	x2

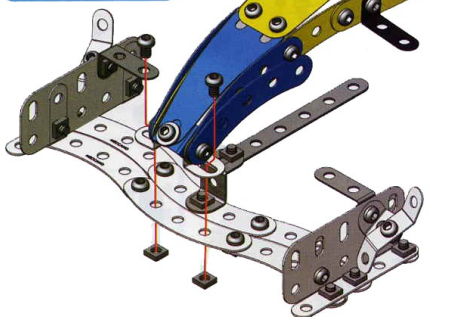

16

(8)+(15)+

	x2	
	x1	
	x2	
	5,8 mm	x4
	16/64	x4

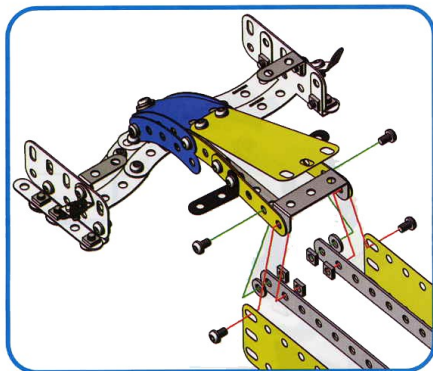
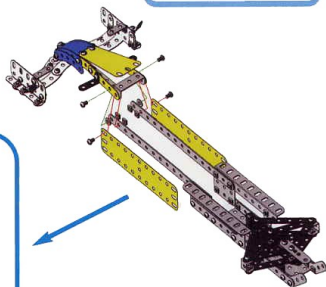

17

	x8	
	5,8 mm	x4
	16/64	x4

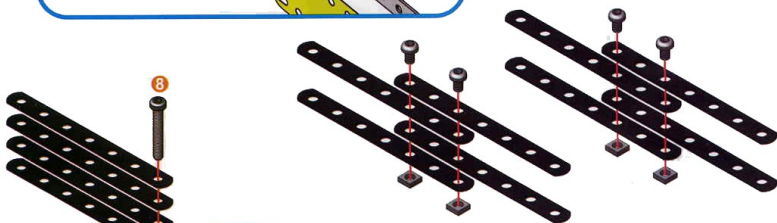

18

	x8	
	x2	
	25,4 mm	x1
	x1	
	x1	

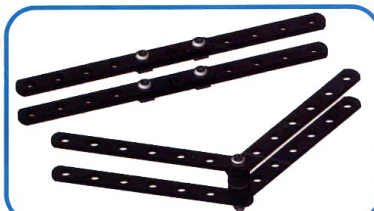

19

16+17+18+

	x2
	x2
	x4
	x2
	x3
	x2
	x2
	x5
	x6
	x7

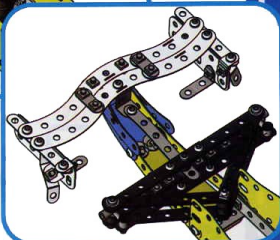
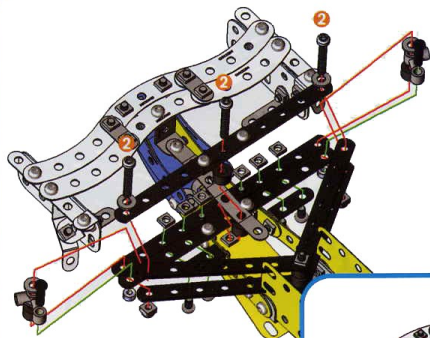

20

	x2
	x2
	x2
	x2
	x2
	x2

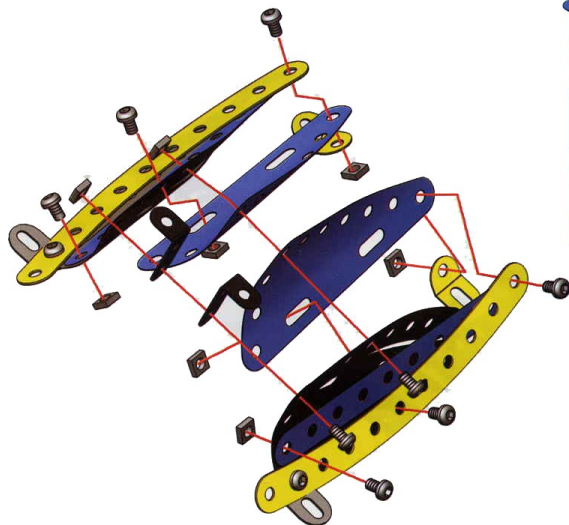
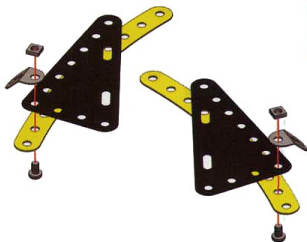

21

20+

	x2
	x2
	x2
	x2
	x2
	x8
	x8

22

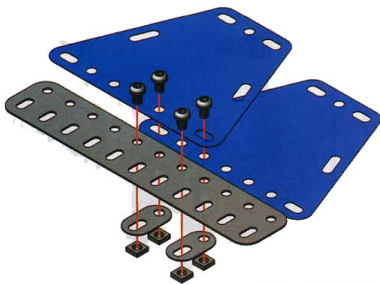
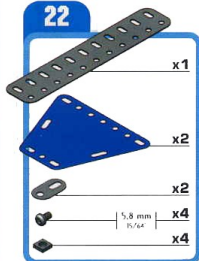

23

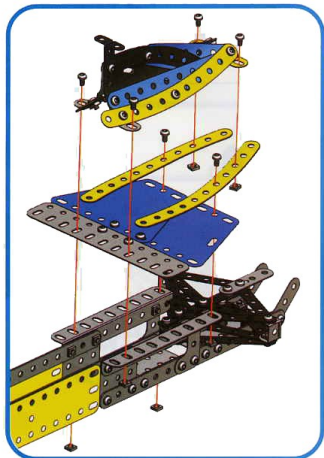
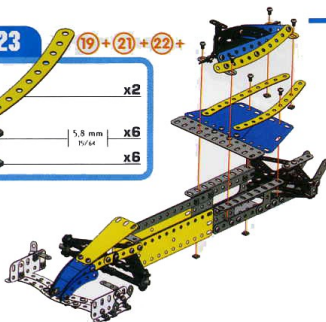
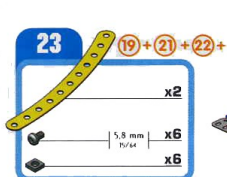

24

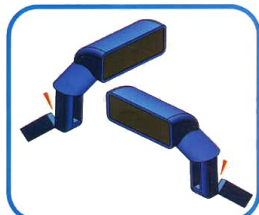
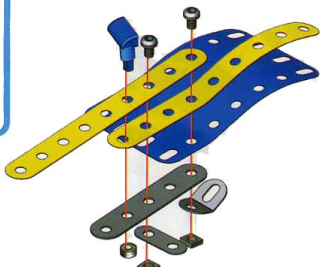
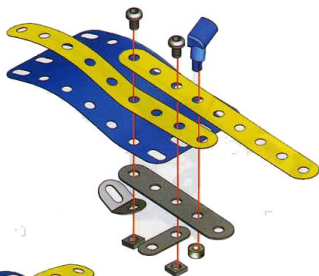
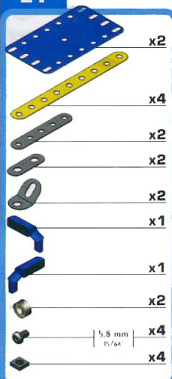

25

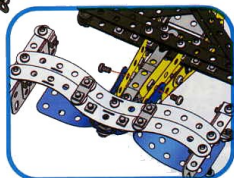
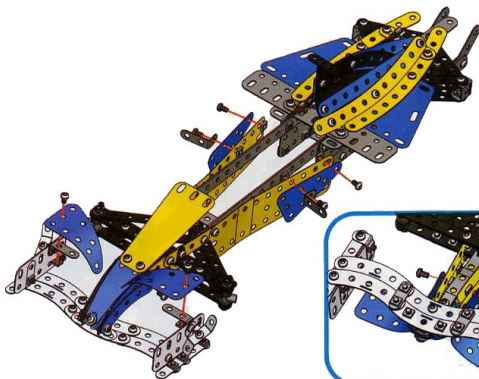
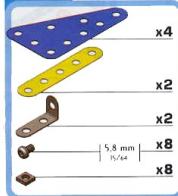

26

(24+)

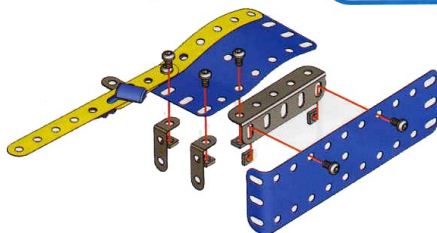
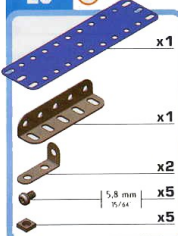

27

(24+)

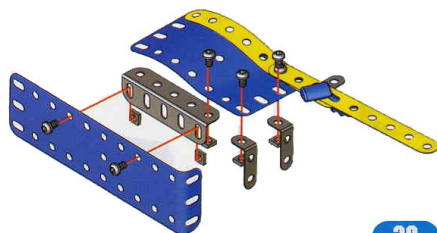
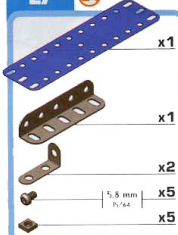

28

(26+)

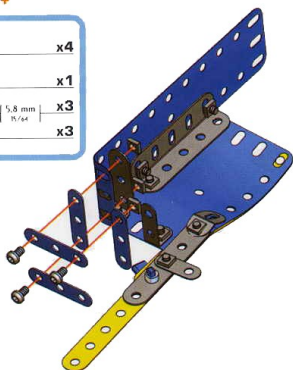
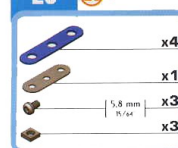

29

(27+)

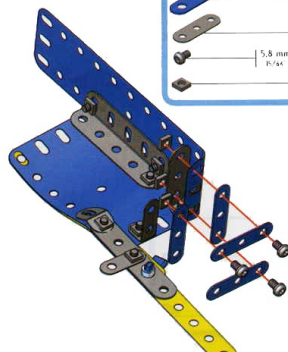
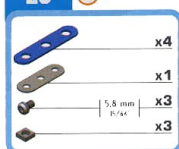

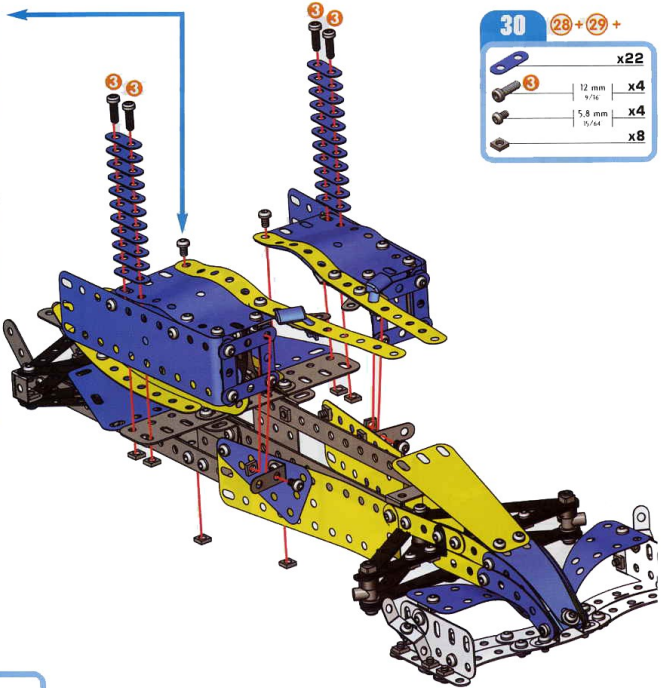
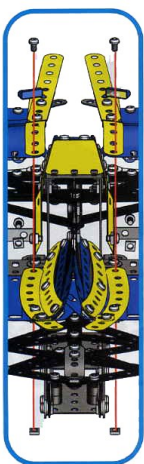

30	(28) + (29) +	
		x22
	12 mm	x4
	9/16"	x4
	5,8 mm	x4
	15/64"	x8

31	
	x1
	5,8 mm
	15/64"
	x3
	x3

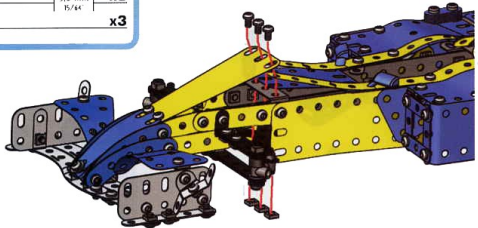

32	
	x2
	x2
	x2
	5,8 mm
	15/64"
	x6
	x6

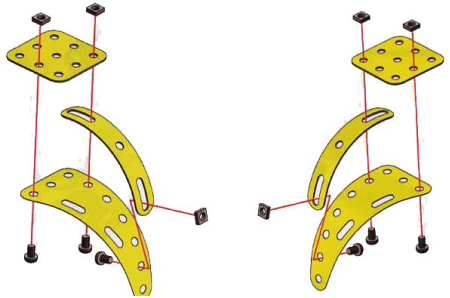

33

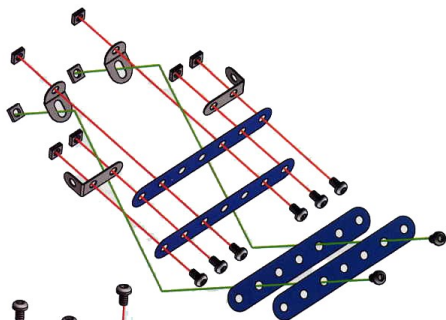
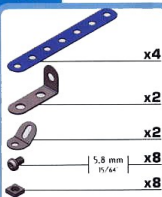

34

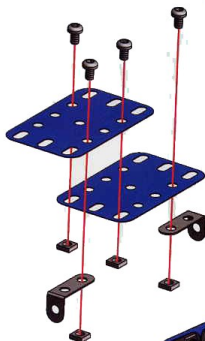
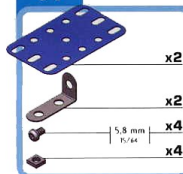

35

33 + 34 +

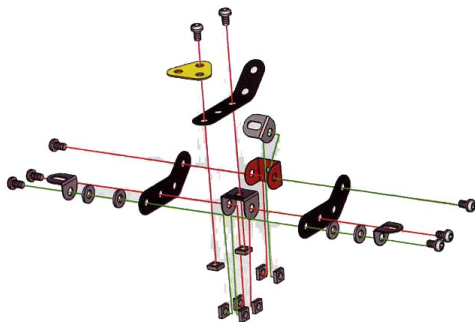
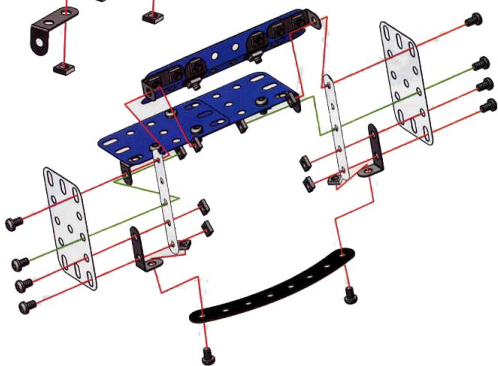
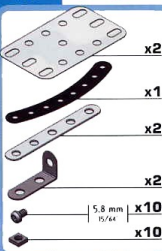

36

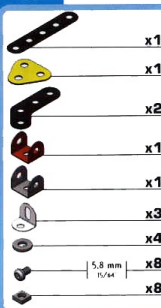

37

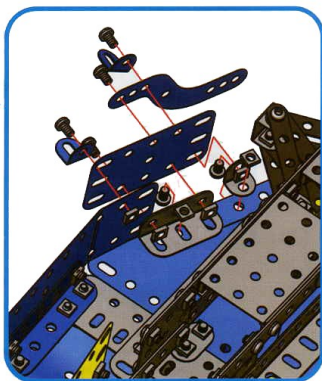
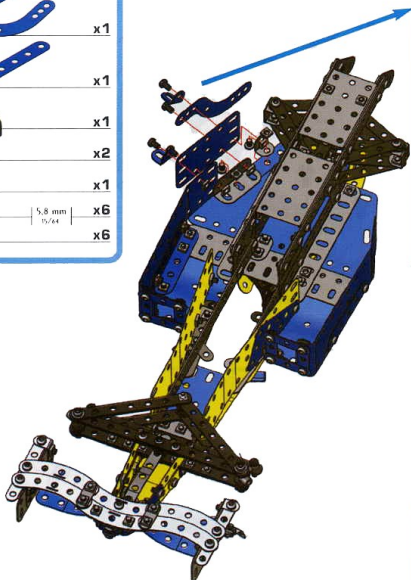
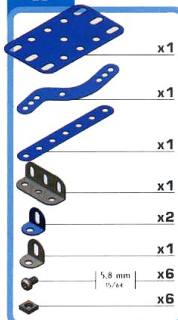



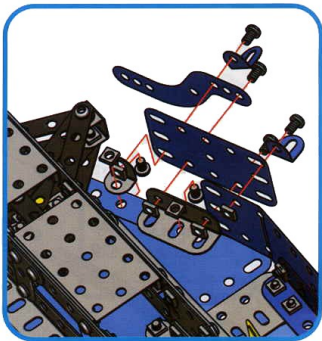
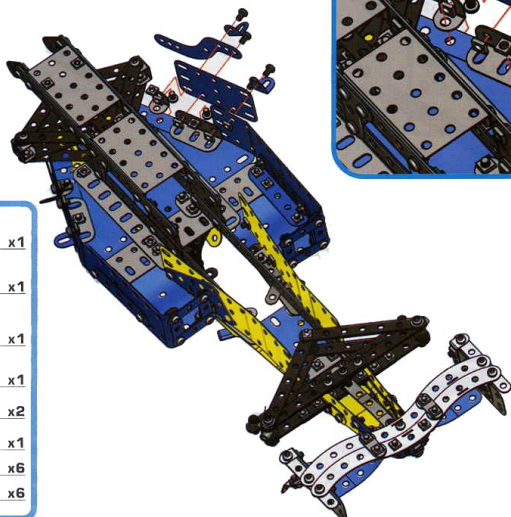
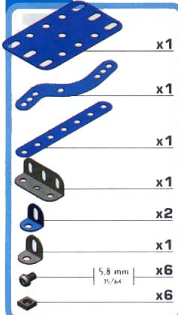

38









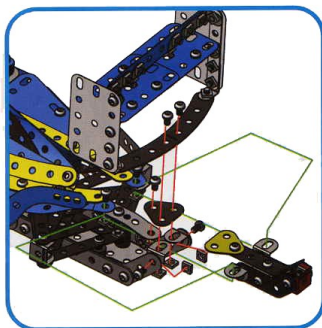



39

39 + 36 +

	x1
	x2
	x7
	x7



40

	x2
	x2
	x2
	x1
	x1
	x1
	x1
	x1
	x1
	x9
	x10

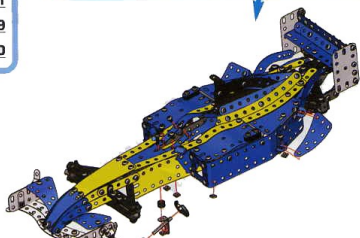
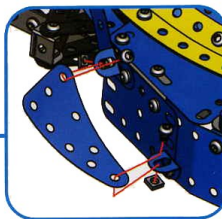
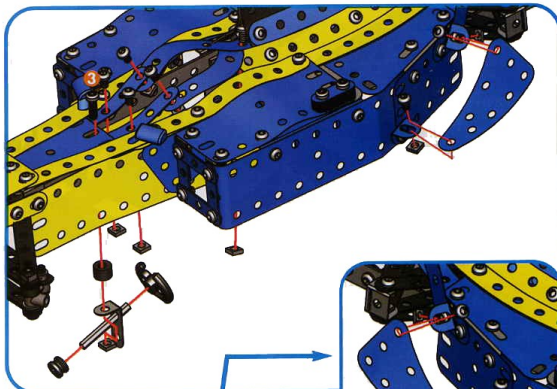

41

	x2
	x2
	x4
	x4
	x4

X2

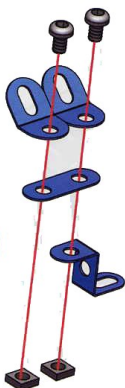

42

	x1
	x2
	x1
	x1
	x2
	x1
	x1
	x1
	x5
	x6

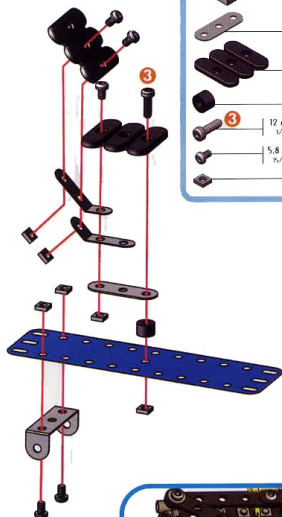

43

32 + 42 +

	x2
	x2
	x6
	x10
	x10

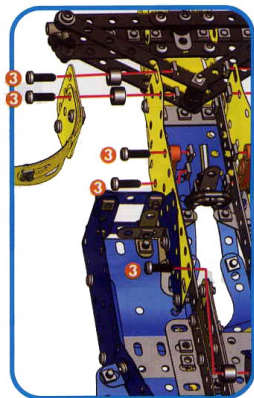
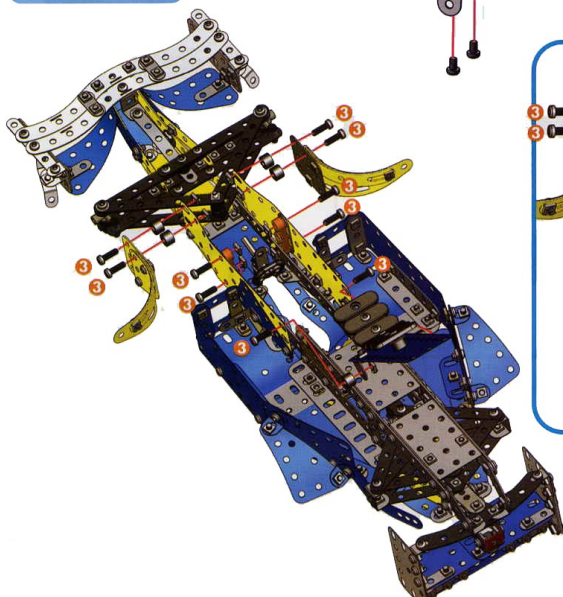

	16,5 mm	x1
		x2
		x2
		x6
		x2
		x2
		x10
	14,7 mm	x2
	29/32	x2
	5,8 mm	x2
	15/64"	x2

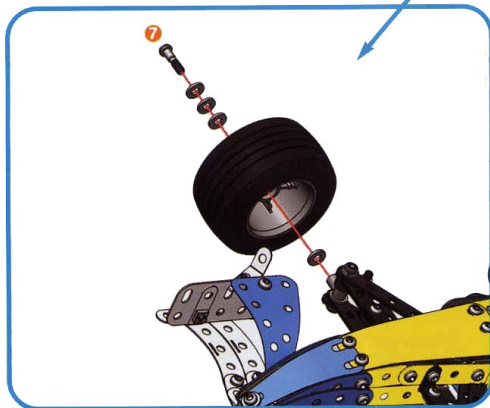
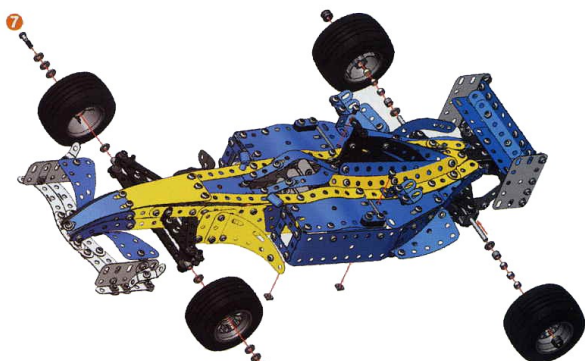

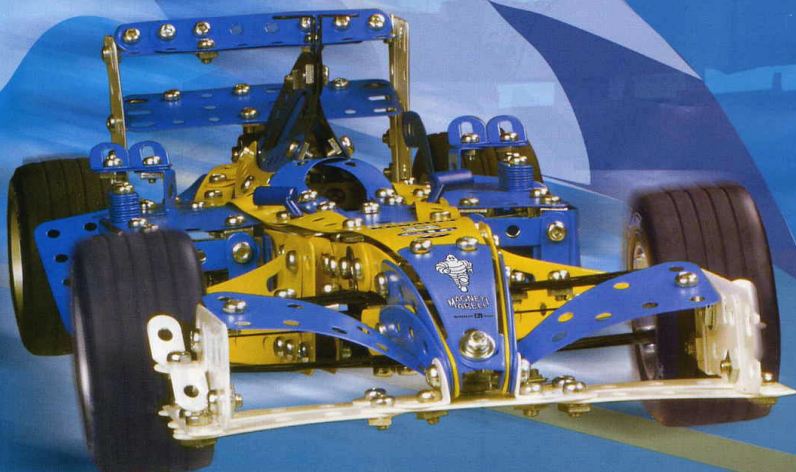
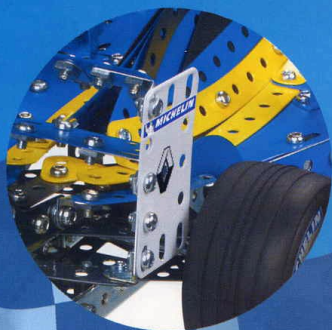

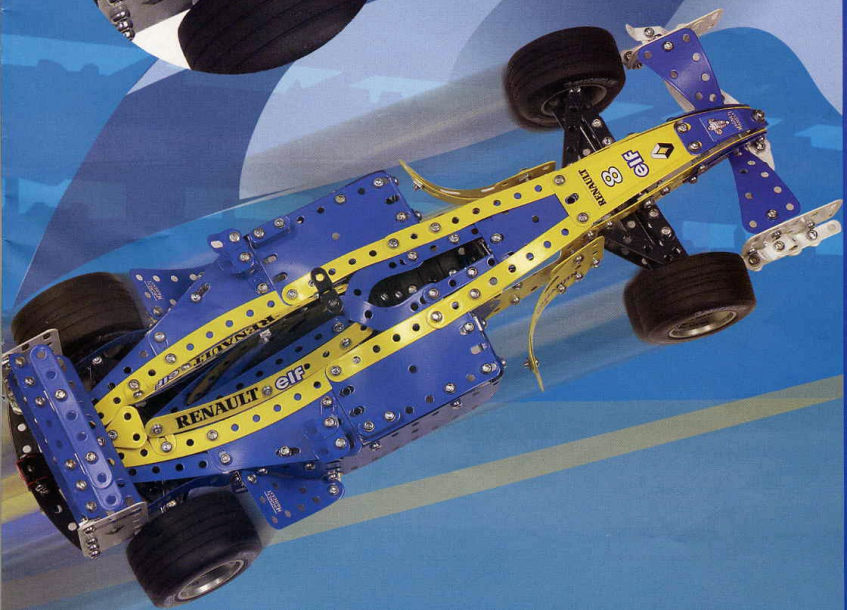

USA Many of the models and component parts are unique and original designs which are the property of MECCANO S.N. They are protected by national legislation as industrial design, trademark and/or copyrights throughout many countries. For detailed information, please contact: MECCANO S.N. Meccano S.N. shall have no responsibility for (I) failure to follow instructions, (II) use of parts for any purpose other than as specified in the instructions (III) any alteration of any parts or components. MECCANO S.N. respects children's safety. All models are tested by children.

F De nombreuses modèles et pièces sont des créations originales, propriétés de MECCANO S.N. et sont protégés par les législations nationales sur les dessins et modèles, marques et/ou droits d'auteurs. Pour toute information, merci de contacter : MECCANO S.N. La responsabilité de MECCANO S.N. ne saurait être engagée en cas d'accident survenu à la suite (I) du non respect des instructions de montage (II) d'une utilisation des pièces autre que celle prévue dans le notice (III) d'une altération ou de la modification des pièces. La société MECCANO respecte la sécurité des enfants : ses modèles sont testés par des enfants.

D Zahlreiche Modelle und Teile sind Erfindungen und Eigentum der Firma MECCANO S.N. Sie sind durch Inland-Gesetze über Zeichnungen und Modelle sowie Warenzeichen und/oder Urheberrechte geschützt. Für weitere Auskünfte wenden Sie sich bitte an: MECCANO S.N. Die Firma Meccano S.N. haftet nicht für Unfälle, die aus der (I) Nichtbeachtung der Bauanleitung, der (II) Verwendung anderer als in der Bauanleitung angegebenen Teile oder der (III) Änderung oder Modifikation der Teile resultieren. Alle Modelle der Firma Meccano wurden von Kindern getestet und entsprechen den Sicherheitsanforderungen.

I Numerosi modelli e pezzi sono creazioni originali della MECCANO S.N. e sono protetti dalle legislazioni nazionali sui disegni e modelli, marchi e/o diritti d'autore. Per qualsiasi informazione, vi invitiamo a prendere contatto con: MECCANO S.N. Meccano S.N. declina ogni responsabilità in caso d'incidenti sopravvenuti in seguito (I) al non rispetto delle istruzioni di montaggio (II) all'uso di pezzi per funzioni diverse da quelle previste nel manuale (III) all'alterazione e/o modifica dei pezzi. La società MECCANO rispetta la sicurezza dei bambini - i suoi modelli vengono testati dai bambini stessi.

E Numerosos modelos y piezas son creaciones originales, propiedades de MECCANO S.N. y están protegidos por las legislaciones nacionales en lo que concierne a los dibujos y modelos, marcas y/o derechos de autor. Para cualquier información, sírvase ponerse en contacto con: MECCANO S.N. MECCANO S.N. carece de responsabilidad en caso de accidente debido a: (I) el incumplimiento de las instrucciones de montaje (II) una utilización de las piezas diferente a la que se indica en las instrucciones (III) una alteración o modificación de las piezas. La sociedad MECCANO respeta la seguridad de los niños - sus modelos están probados por niños.

P Vários modelos e peças são criações originais, propriedades da MECCANO S.N. e são protegidos pelas legislações nacionais relativas aos desenhos e modelos, às marcas e/ou aos direitos de autor. Para qualquer informação, é favor contactar : MECCANO S.N. A Sociedade MECCANO S.N. não poderá ser responsabilizada pelos acidentes provocados: (I) pela falta de cumprimento das instruções de montagem (II) pela sua utilização das peças ou (III) pela modificação ou alteração dos peças. A Sociedade MECCANO respeita a segurança das crianças - os seus modelos foram testados por crianças.

S Många modeller och delar bildar en unik och originell formgivning vilken är MECCANO S.N. egendom. Dessa modeller och delar är skyddade genom lagstiftning såsom industriell formgivning, varumärke och/eller

upphovs rättigheter i ett eller flera länder. För mer detaljerad information, var vänlig och kontakta MECCANO S.N. MECCANO S.N. fraktar sig all ansvar i händelse av olycka till följd av (I) att monteringsinstruktionerna inte har respekterats, (II) en annan användning av delarna än den som står i ovanstående (III) en försvackning eller förändring av delarna. Företaget MECCANO respekterar barnsäkerheten - modellerna har testats av barn.

FIN Useet mallit ja osat ovat MECCANO S.N. -n omisuojella olevia omaperäisiä suunnitelmia. Ne ovat kansallisia lailla suojeittuja teollisia tuotantolaitteita, tavaramerkkejä jne.äi kopiointiloukkia. Pyynnämme ottamassa yhteyden MECCANO S.N.; hän kaikissa osuissa liittyvissä kysymyksissä. MECCANO S.N. ei vastaa eikä katso vastuuvastuuta syistä sattuneista onnettomuuksista: (I) ohjeiden vastainen kokoonpano, (II) muuten kuin ohjeissa määrättyjen osien käyttö, (III) osien muuttaminen tai eri tarkoituksiin käyttö. MECCANO-yhtiön huolehtii lasten turvallisuudesta: lapset ovat testanneet mallimme.

DK Væge mange modeller og dele er originale fremstillinger og ejes af MECCANO S.N. Tegninger, modeller, fabrikationsmærker og oplysninger er lovbeskyttet i hvert land. Yderligere oplysninger kan fås hos: MECCANO S.N. MECCANO S.N. frægter sig ethvert ansvar, såfremt der er sket ulovlig forbrug af (I) et monteringsinstruktionsark eller et blevet overholdt, (II) et delene er blevet brugt til andre formål, end dem der er beskrevet i betjeningsvejledningen, (III) eller et delene er blevet beskadiget eller ændret. MECCANO overholder sikkerhedsreglerne for børn: Alle modeller testes af børn.

NL Veel modellen en onderdelen zijn origineel ontworpen en eigendom van MECCANO S.N. en worden beschermd door de nationale wetgeving op tekensamen, modellen, merken en/of auteursrechten. Voor informatie gelieve contact op te nemen met MECCANO S.N. De verantwoordelijkheid van MECCANO S.N. is uitgesloten in geval van ongelukken voortvloeiend uit het niet naleven van de montage-instructies (I), uit het gebruik van andere onderdelen dan die zoals vermeld in de handleiding (II) of uit het veranderen of modificeren van de onderdelen (III). De firma MECCANO neemt de veiligheid van de kinderen in acht - de modellen zijn door kinderen getest.

GR Πολλά μοντέλα και συστατικά είναι αυθεντικά, ιδιοκτησία της MECCANO S.N. και προστατεύονται από τις ελληνικές νομοθεσίες. Για τα μοντέλα της εταιρείας ή τα διακριτικά εμπορικών της και/ή πληροφοριακά παρακαλώ απευθυνθείτε στη MECCANO S.N. Η εταιρεία της MECCANO S.N. δεν δεχεται κανένα είδος ευθύνης για ατυχήματα που είναι συνέπεια (I) μη εφαρμογής των οδηγιών συναρμολόγησης (II) χρήσης των τεμαχίων διαφορετικά από αυτόν που προτείνεται στις οδηγίες (III) καταστολής ή αλλαγής των τεμαχίων. Η εταιρεία MECCANO σεβάζεται την ασφάλεια των παιδιών: τα μοντέλα της δοκιμάζονται από παιδιά.

JPN モデルならびに部品は、その多くがMECCANO社所有のオリジナル・デザインで、設計・発想および製造は専ら中国に属する国内法によって保護されています。詳細については、弊社 (MECCANO S.N.) メカノ社は品質改善を専ら行なうた場合、例 使用説明書に記載されたもの以外の部品を使用した場合、例 部品を改造・改造した場合は必ず記載された事項については責任を負うことはできません。メカノ社の安全手冊は事前に子供たちよりテストされています。その安全性を厳格確認されています。

Made in France by / Fabriqué en France par / Fabricado en Francia por :



363, avenue de Saint Expéry
62100 Calais - France
<http://www.meccano.com>

© 09/2003 MECCANO S.N.

® MECCANO and ERECTOR are exclusive trademarks of MECCANO S.N.
All rights reserved