

MASTER CONNECTION

0:49.2

0:32.0

0:36.4

0:75.0

0:58.3

0:54.1

0:92.3

0:48.6

0:78.1

0:51.3

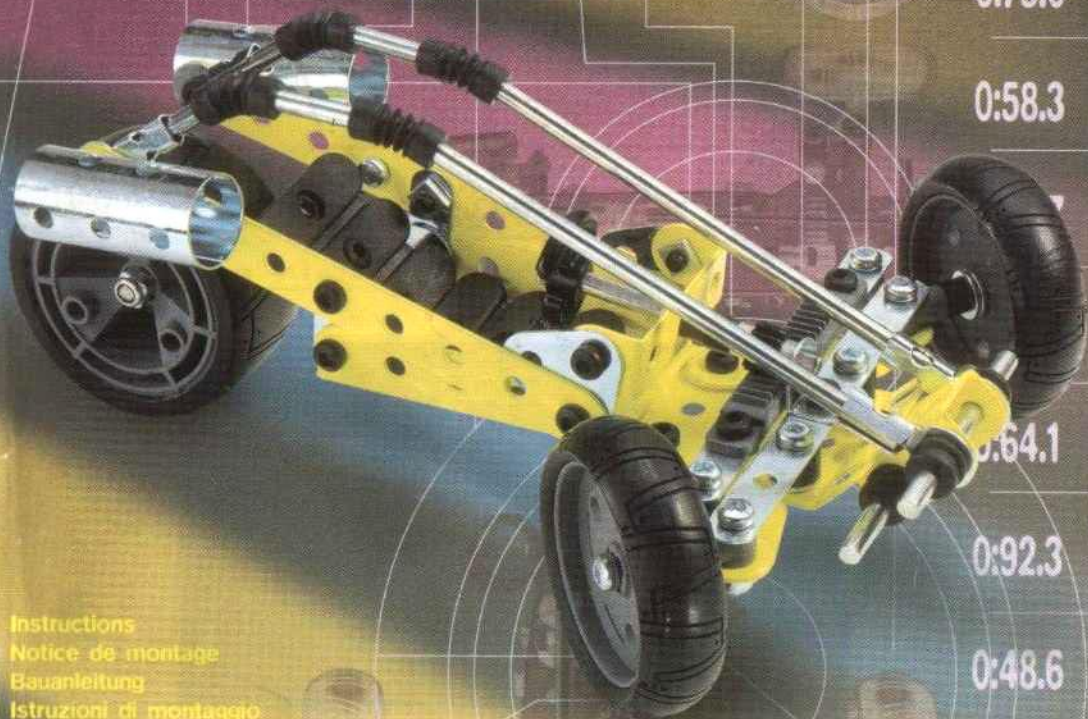

Instructions
Notice de montage
Bauanleitung
Istruzioni di montaggio
Instrucciones de montaje
Instruções de montagem
Monteringsanvisning
Kokoamisohje
Monteringsinstruktioner
Montagehandleiding
Οδηγίες συναρμολόγησης
組立說明書

0020



8-14

0:49.2

0:32.0

0:36.4

0:75.0

0:58.3

0:63.7

0:86.5

0:64.1

0:92.3

0:48.6

0:78.1

0:51.3

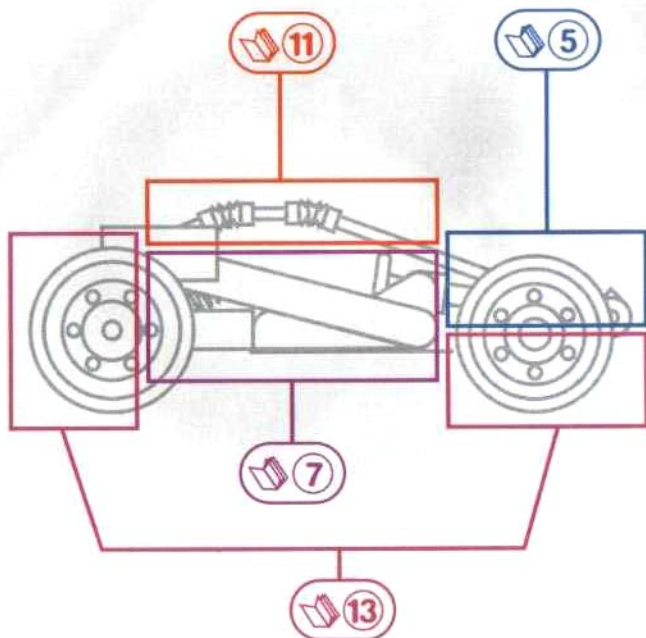

0:49.2
0:32.0
0:36.4
0:75.0
0:58.3
0:63.7
0:86.5
0:64.1
0:92.3
0:48.6
0:78.1
0:51.3



2

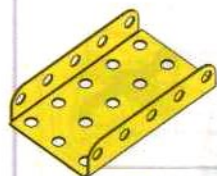

51F x1

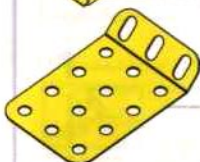

73A x1



77 x2



163 x2



133C x2



48 x1



51C x1



812D x1



12 x1



177A x2



110C x1

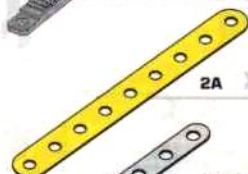

2A x2

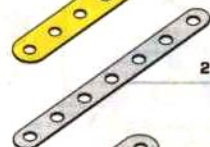

235B x2



5 x1



806B x2



15B x2



16A x1



17 x1



317 x1



18B x4



34 x1



36C x1



321A x1



187B x2



142P x2



187C x1



142R x1



111D x1



111 x2



111A x4



111C x1



147D x4



37B x21



37A x24



37H x8



38 x11



38A x3



38B x4



23C x4



59B x3



25B x1



120DF x1



120DM x1



120DR x1



212 x4



213C x4



260F x2

0:49.2

0:32.0

0:36.4

0:75.0

0:58.3

0:63.7

0:86.5

0:64.1

0:92.3

0:48.6

0:78.1

0:51.3

0:49.2

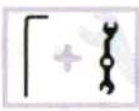

0:32.0



0:36.4

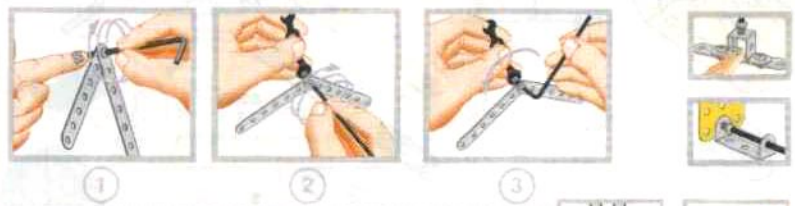

0:75.0



0:58.3

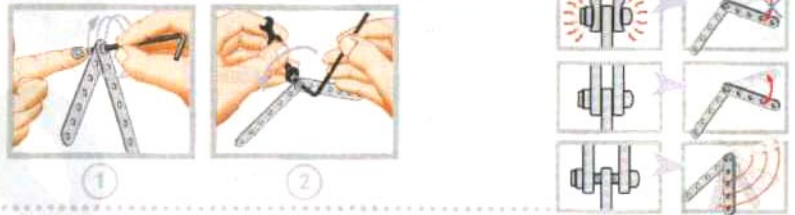

0:63.7



28 mm

1 1/8"



Scale
Échelle
Maßstab
Scala

Escala
Schaal
Escala
Skala

Mittakaava
Målestok
Κλίμακα
スケール

1:1

0:86.5

19 mm

3/4"

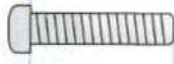

0:64.1

14,7 mm

9/16"



0:92.3

12 mm

1/2"

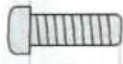

0:48.6

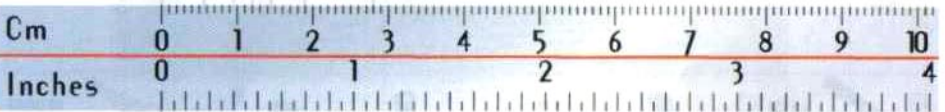

0:78.1

25 mm

1"



0:51.3

50 mm

2"

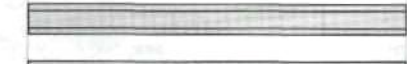

50 mm

2"

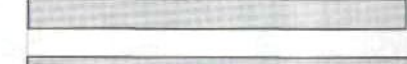

60 mm

2 1/2"

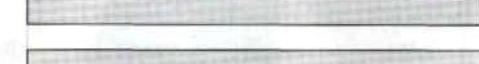

100 mm

4"

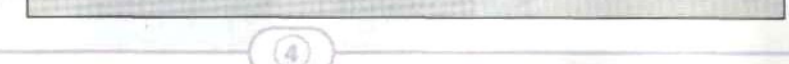

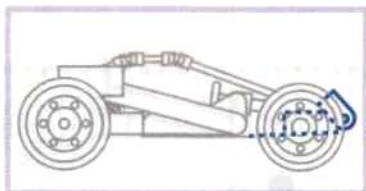

0:49.2

1

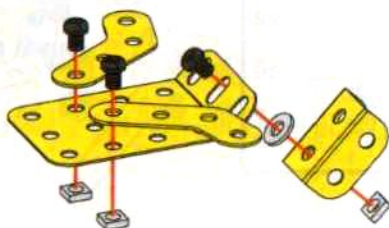
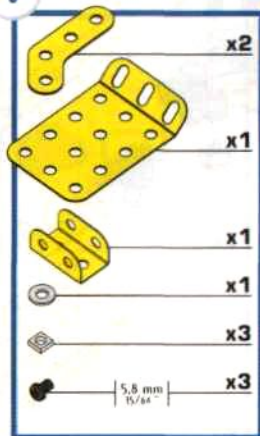

0:32.0

0:36.4

0:75.0

0:58.0

0:63.7

2

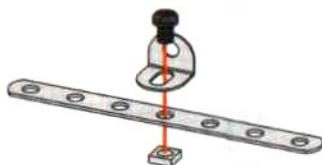
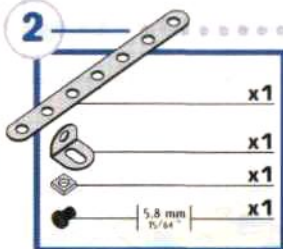

0:86.5

0:64.1

3

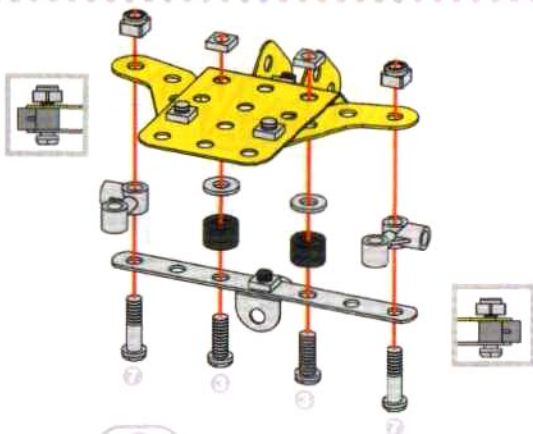
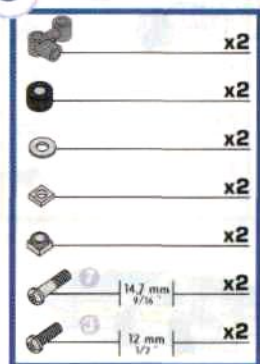

0:92.3

0:48.6

0:78.1

0:51.3

5

4

0:49.2

0:32.0

0:36.4

0:75.0

0:58.3

0:63.7

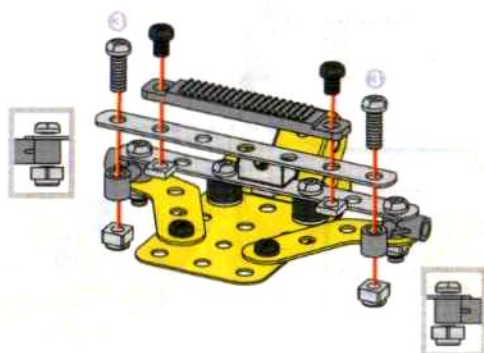
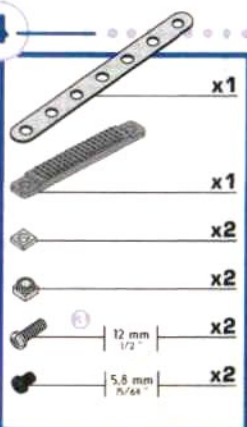

5

0:86.5

0:64.1

0:92.3

0:48.6

0:76.1

0:51.3

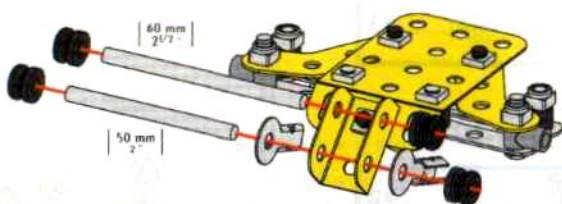
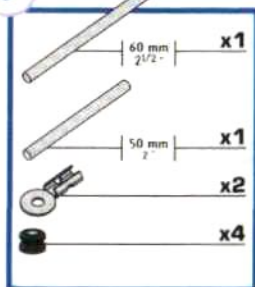

6

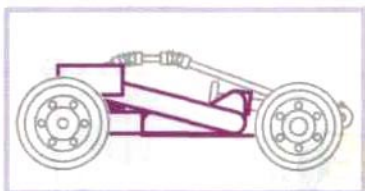

0:49.2

1

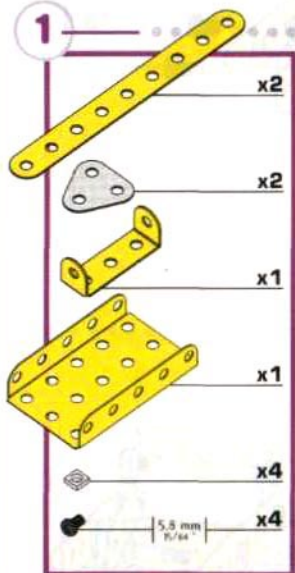

0:32.0

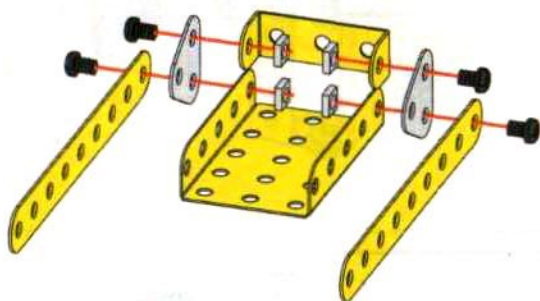

0:36.4

0:75.0

0:58.3

0:63.7

0:86.5

2

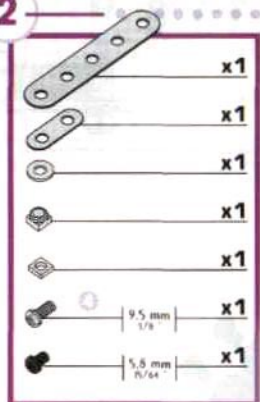

0:64.1

0:92.3

0:48.6

0:78.1

0:51.3

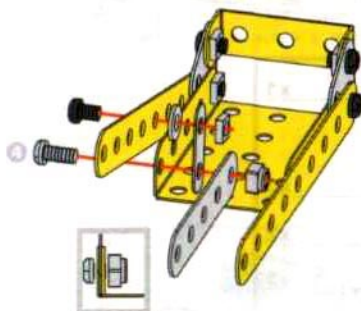

3

0:49.2

0:32.0

0:36.4

0:75.0

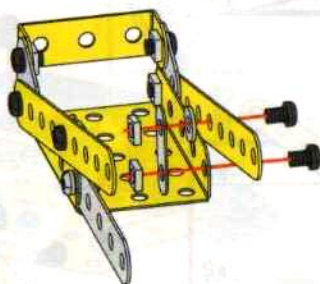
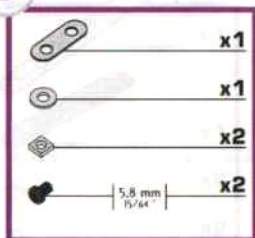

4

0:58.3

0:63.7

0:86.5

0:64.1

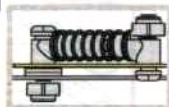
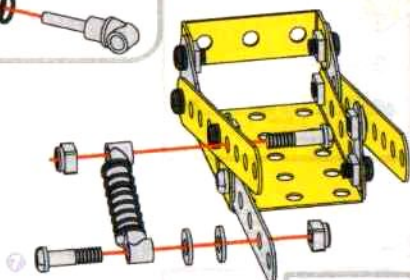
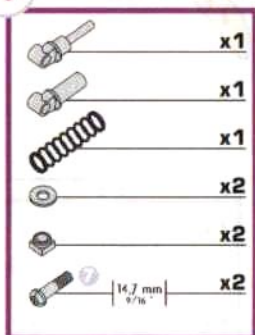

5

0:92.3

0:48.6

0:78.1

0:51.3

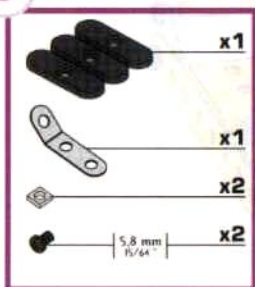

6

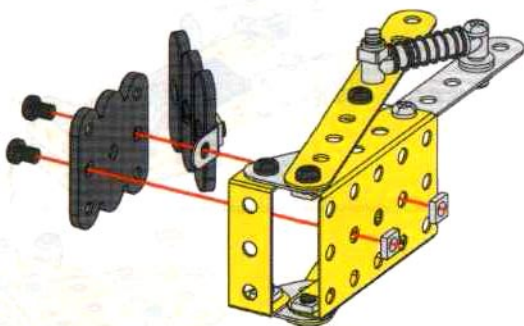

0:49.2

0:32.0

0:36.4

0:75.0

0:58.3

7

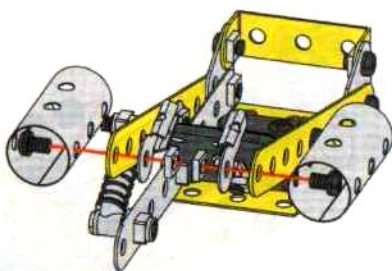
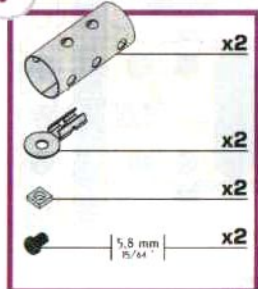

0:63.7

0:86.5

0:64.1

0:92.3

0:48.6

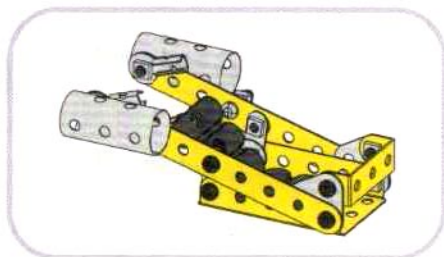



0:78.1

0:51.3

9

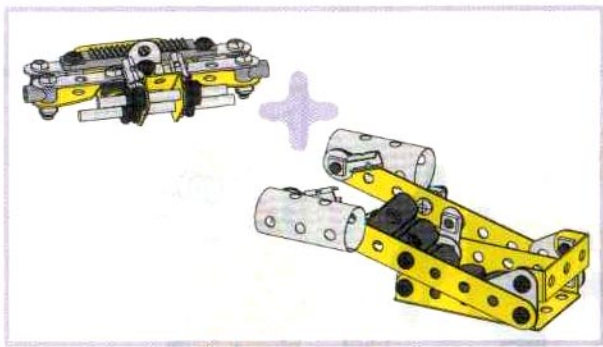
0:49.2
 0:32.0
 0:36.4
 0:75.0
 0:58.3
 0:63.7
 0:86.5
 0:64.1
 0:92.3
 0:48.6
 0:78.1
 0:51.3



-  50 mm $\frac{1}{2}$ " x1
-  x1
-  x1
-  x3
-  x2
-  x2
-  5.8 mm $\frac{9}{64}$ " x2

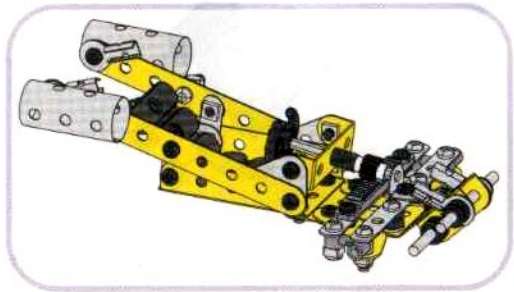
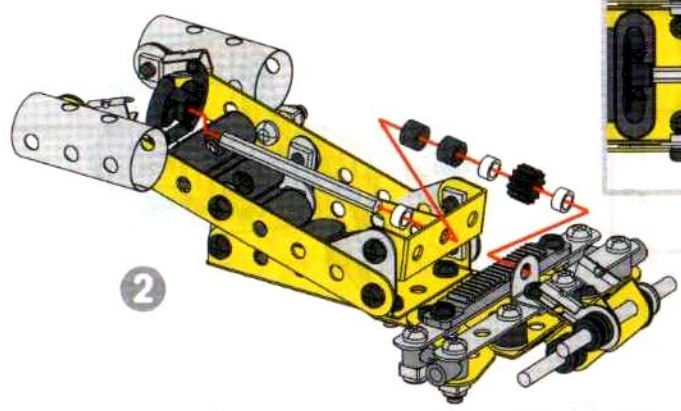
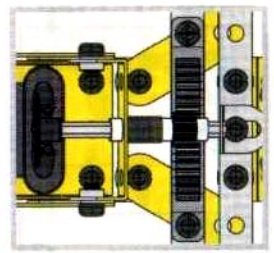
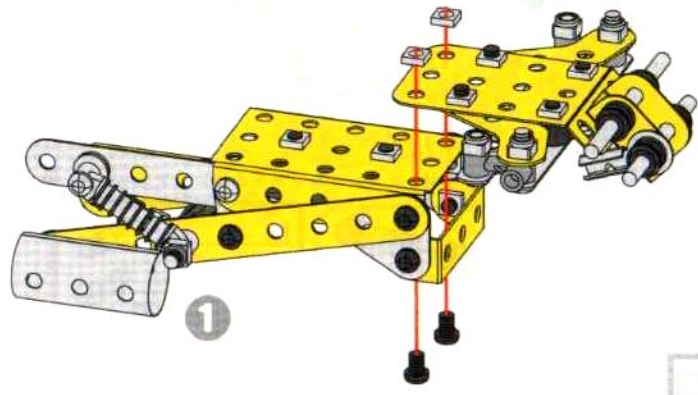

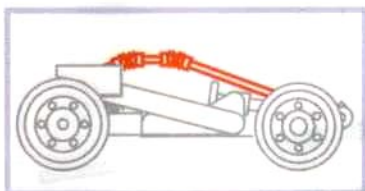

0:49.2

1

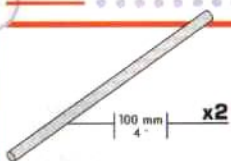

x2



x4



x4

0:32.0

0:36.4

0:75.0

0:58.3



0:63.7

0:86.5

0:64.1

0:92.3

0:48.6



X2

0:78.1

0:51.3

0:49.2

0:32.0

0:36.4

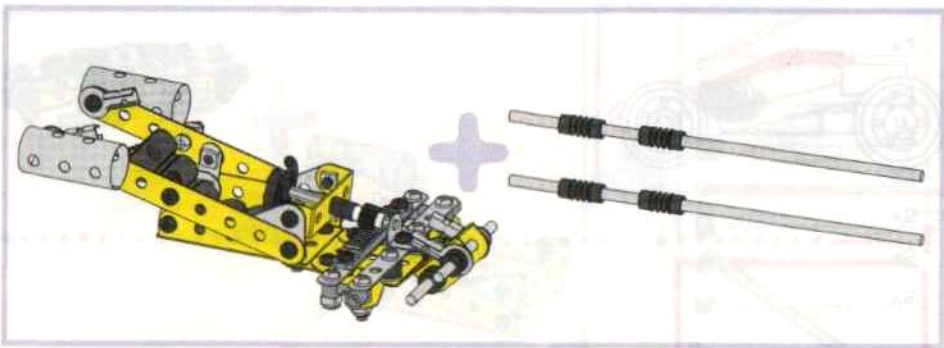

0:75.0

0:58.3

0:63.7

0:86.5

0:64.1

0:92.3

0:48.6

0:78.1

0:51.3

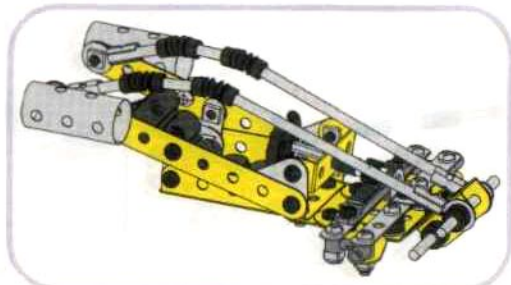
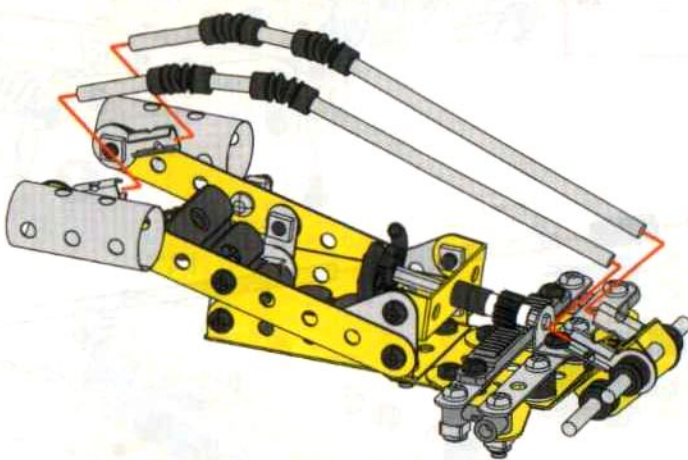

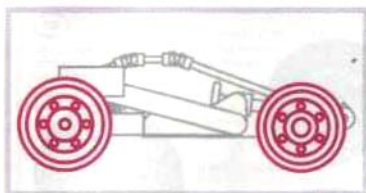

0:49.2

1

0:32.0



0:36.4



0:75.0

0:58.3



0:63.7



0:86.5

2

0:64.1

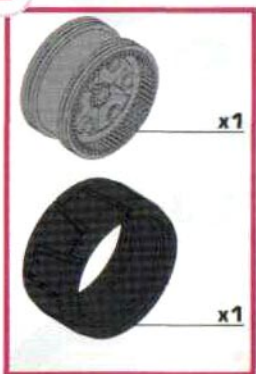

0:49.3

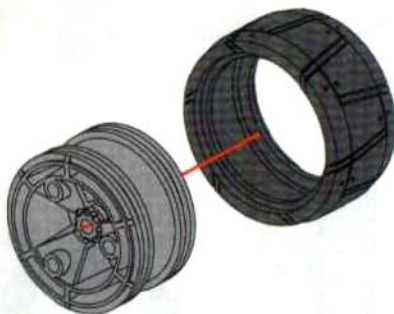

0:48.5

0:78.1



0:51.3

0:49.2

0:32.0

0:35.4

0:75.0

0:2

0:63.7

0:86.5

0:64.1

0:92.3

0:48.6

0:78.1

0:51.3

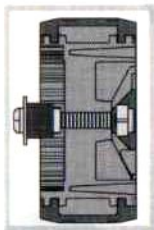
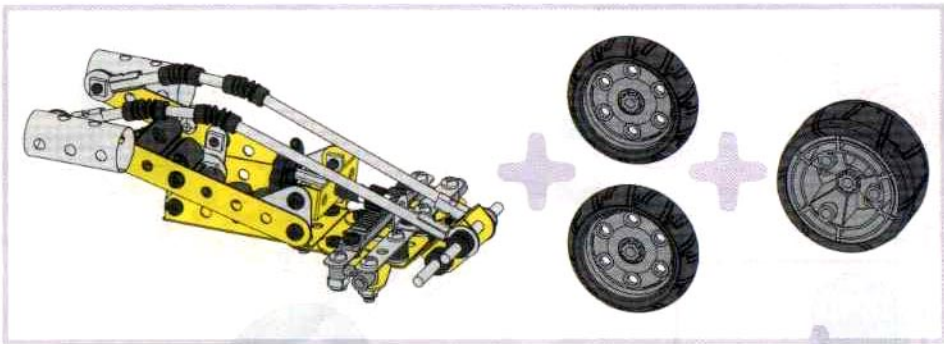

	x2
	x1
	x4
	x1
	x1
	28 mm 1 1/8" x1
	19 mm 3/4" x2

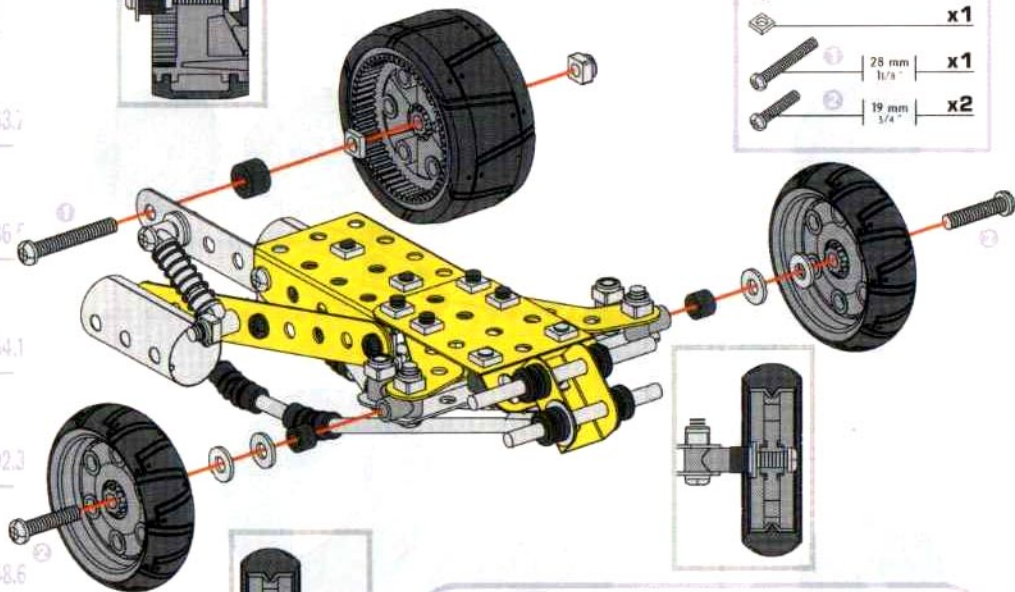

GB Many of the models and component parts are unique and original designs which are the property of MECCANO S.A. They are protected by national legislation as industrial designs, trademarks and/or copyrights throughout many countries. For detailed information, please contact MECCANO S.A.

MECCANO S.A. accepts no responsibility for (I) failure to follow instructions, (II) use for any purpose other than as specified in the instructions (III) any alteration of any parts or components.
MECCANO S.A. respects children's safety: all models are tested by children.

F De nombreux modèles et pièces sont des créations originales, propriétés de MECCANO S.A. et sont protégés par les législations nationales sur les dessins et modèles, marques et/ou droits d'auteurs. Pour toute information, merci de contacter : MECCANO S.A.
La responsabilité de MECCANO S.A. ne saurait être engagée en cas d'accident survenu à la suite (I) du non respect des instructions de montage (II) d'une utilisation des pièces autre que celle proposée dans la notice (III) d'une altération ou de la modification des pièces.
La société MECCANO respecte la sécurité des enfants : ses modèles sont testés par des enfants.

D Zahlreiche Modelle und Teile sind Erfindungen und Eigentum der Firma MECCANO S.A. Sie sind durch Inland-Gesetze über Zeichnungen und Modelle sowie Warenzeichen und/oder Urheberrechte geschützt. Für zusätzliche Auskünfte wenden Sie sich bitte an : MECCANO S.A.
Die Firma Meccano S.A. haftet nicht für Unfälle, die aus der (I) Nichtbeachtung der Bauanleitung, der (II) Verwendung anderer als in der Bauanleitung angegebenen Teile oder der (III) Änderung oder Modifikation der Teile resultieren.
Alle Modelle der Firma Meccano S.A. wurden von Kindern getestet und entsprechen den Sicherheitsnormen.

I Numerosi modelli e pezzi sono creazioni originali della MECCANO S.A. e sono protetti dalle legislazioni nazionali sui disegni e modelli, marche e/o diritti d'autore. Per qualsiasi informazione, vogliate prendere contatto con: MECCANO S.A.
Meccano s.a. declina ogni responsabilità in caso d'incidenti sopravvenuti in seguito (I) al non rispetto delle istruzioni di montaggio, (II) utilizzo dei pezzi per funzioni diverse da quelle previste nel manuale (III); alterazione e/o modifica dei pezzi.
La società MECCANO rispetta la sicurezza dei bambini: i suoi modelli vengono testati dai bambini stessi.

E Numerosos modelos y piezas son creaciones originales, propiedades de MECCANO S.A. y están protegidos por las legislaciones nacionales en lo que concierne a los dibujos y modelos, marcas y/o derechos de autor. Para cualquier información, envíase por favor en contacto con: MECCANO S.A.

MECCANO S.A. carece de responsabilidad en caso de accidente debido a: (I) el incumplimiento de las instrucciones de montaje; (II) una utilización de las piezas diferente a la que se indica en las instrucciones; (III) una alteración o modificación de las piezas.
La sociedad MECCANO respeta la seguridad de los niños: sus modelos están probados por niños.

P Vários modelos e peças são criações originais, propriedades da MECCANO S.A. e são protegidos pelas legislações nacionais relativas aos desenhos e modelos, às marcas e/ou aos direitos de autor. Para qualquer informação, é favor contactar: MECCANO S.A.
A Sociedade MECCANO S.A. não poderá ser responsabilizada pelos acidentes provocados: (I) pela falta de cumprimento das instruções de montagem; (II) pelo uso indevido das peças ou (III) pela modificação ou alteração das peças.
A Sociedade MECCANO respeita e segurança das crianças: os seus modelos foram testados por crianças.

S Många modeller och delar bilar en unik och originell formgivning vilken är MECCANO S.A. egendom. Dessa modeller och delar är skyddade genom lagstiftning såsom industriell formgivning, varumärke och/eller upphovsmanrätt i ett flertal länder. För mer detaljerad information, var vänlig och kontakta MECCANO S.A.
MECCANO S.A. fraktar sig allt ansvar i händelse av olycka till följd av (I) att monteringsinstruktionerna inte har respekterats (II) i anrikan användning av delarna än den som står i anvisningen (III) en försvanskning eller förändring av delarna.
Företaget MECCANO respekterar barnsäkerheten: modellerna har testats av barn.

FIN Vore mange modeller og dele er originale fremstillinger og ejes af MECCANO S.A. Tegninger, modeller, fabrikmærker og ophavsret er lovbeskyttede i hvert land. Yderligere oplysninger kan fås hos: MECCANO S.A.
MECCANO S.A. ej vastaaux ei katta seuraavista syistä sattuneita onnettomuuksia: (1) ohjeiden vastainen kokoaminen, (2) muiden kuin ohjeissa ehdotettujen osien käyttö, (3) osien väpö tai muurttelu.
MECCANO-yhtiö huolehtii lasten turvallisuudesta: lapset ovat testanneet mallimme.

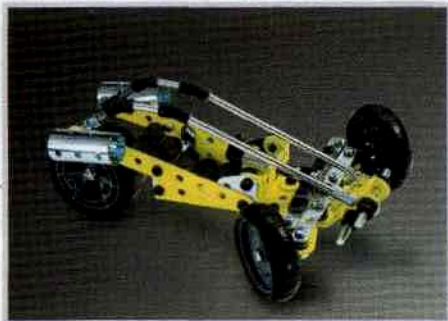

DK Useet mallit ja osat ovat MECCANO S.A.:n omaisuutta olevaa suunnittelua. Useat mallit ja niiden osat ovat lailla suojattua teollista tuotantoa, tavaramerkkejä ja/tai kopiointiloukkuisia useissa maissa.
Tuotekehittäjä MECCANO S.A. vastaa siitä, että (I) monteringsinstruktionerne ikke er blevet overholdt, (II) at delene er blevet brugt til andre formål, end dem der er beskrevet i betjeningsvejledningen, (III) eller at delene er blevet beskadiget eller ændret, frasier MECCANO S.A. sig ethvert ansvar for dette.
MECCANO overtønder sikkerhedsreglerne for børn: alle modeller testes af børn.

NL Veel modellen en onderdelen zijn originele ontwerpen en eigendom van MECCANO S.A. en worden beschermd door de nationale wetgevingen op tekeningen en modellen, merken en/of auteursrechten.
Voor informatie gelieve contact op te nemen met MECCANO S.A.
De verantwoordelijkheid van MECCANO S.A. is uitgesloten in geval van ongevallen voortvloeiend uit het niet naleven van de montage-instructies (I), uit het gebruik van andere onderdelen dan die zoals vermeld in de handleiding (II) of uit het veranderen of modificeren van de onderdelen (III).
De firma MECCANO neemt de veiligheid van de kinderen in acht: de modellen zijn door kinderen getest.

GR Πολλά μοντέλα και ανταλλακτικά είναι αυθεντικά, ιδιοκτησία της MECCANO S.A. και προστατεύονται από τις εθνικές νομοθεσίες για τα μοντελαπτε μάρκες ή τα δικαιώματα ευρεσιτεχνίας. Για κάθε πληροφορία παρακαλώ απευθυνθείτε στη MECCANO S.A.
Η ευθύνη της MECCANO S.A. δεν δεσμεύεται σε περίπτωση ατυχήματος που έγινε συνεχώς (I) μη σεβασμού των οδηγιών συναρμολόγησης (II) χρήσης των τμημάτων διαφορετική από αυτή που προτείνεται στις οδηγίες (III) καταστροφή ή αλλαγή των τμημάτων.
Η εταιρεία MECCANO σέβεται την ασφάλεια των παιδιών: τα μοντέλα της δοκιμάζονται από παιδιά.

JPN モデルならびに部品は、その多くがMECCANO社所有のオリジナル・デザインで、登録・商標および/または著作権に関する国内法によって保護されています。詳細については、当社 (MECCANO S.A.) メカノ社は、(I) 前立の注意事項を守らなかった場合、(II) 使用説明書に記されたもの以外の部品を使用した場合、(III) 部品を変更・改造した場合などに起きた事故については責任を負うことはできません。
メカノ社の全モデルは事前に子供たちによりテストを行い、その安全性を確認しております。

USA Many models and component parts incorporate original designs which are the property of MECCANO S.A. and are protected as design and/or utility patent and/or copyrights. For detailed information, please contact MECCANO S.A. Instruction booklets are solely to assist in construction of sets. MECCANO S.A. shall have no responsibility for:
1. Failure to follow instructions
2. Use of parts for any purpose other than as specified in the instruction booklets.
3. Any alteration of any parts or components.
Meccano S.A. values children's safety: all models are tested accordingly.
All models are tested by and developed in conjunction with children.

Made in France by / Fabriqué en France par / Hecho en Francia :

Meccano S.A. 363, avenue de Saint-Exupéry - F - 62100 CALAIS

0:49.2

0:32.0

0:36.4

0:75.0

0:58.3

0:63.7

0:86.5

0:64.1

0:92.3

0:48.6

0:78.1

0:51.3

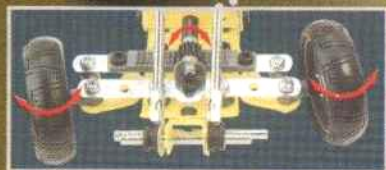

MECCANO

363, avenue de Saint-Exupéry
F - 62100 CALAIS



MECCANO® and ERECTOR® are exclusive trademarks of MECCANO S.A.

© March, 1998 MECCANO S.A.