

INSTRUCTION LOG BOOK

LIVRO DE BORDO PARA MONTAGEM

CARNET DE BORD DE MONTAGE

MONTIERINGS-PROTOKOLL

BAUANLEITUNG

ASENNUKSEN LOKIKIRJA

LIBRETTO DI BORDO PER IL MONTAGGIO

MONTAGE HÆFTE

DIARIO DE A BORDO DE MONTAJE

ΣΗΜΕΙΩΜΑΤΑΡΙΟ ΣΥΝΑΡΜΟΛΟΓΗΣΗΣ

MONTAGEDAGBOEK

組み立て説明書

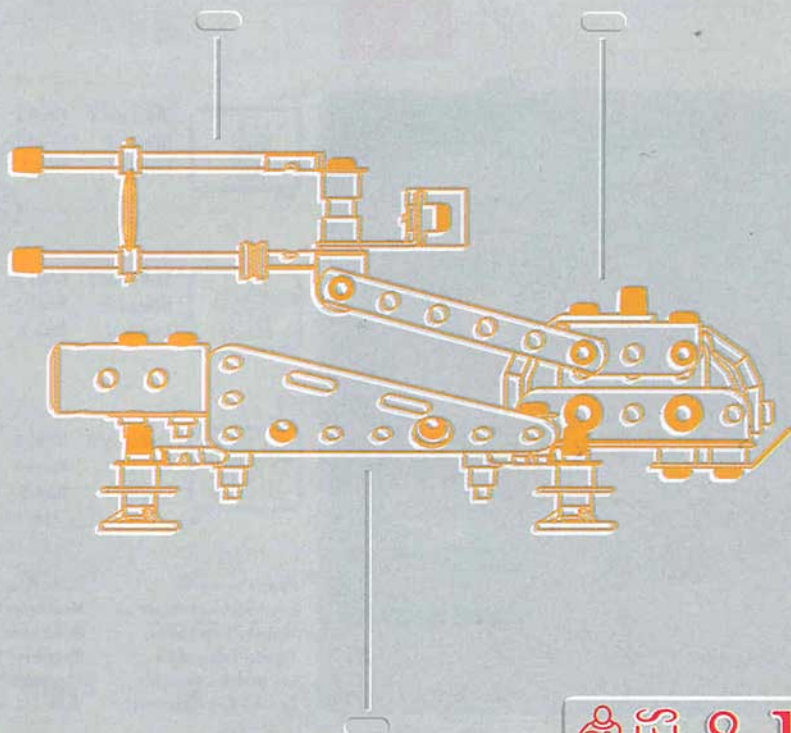

4806

 AGES 8-12

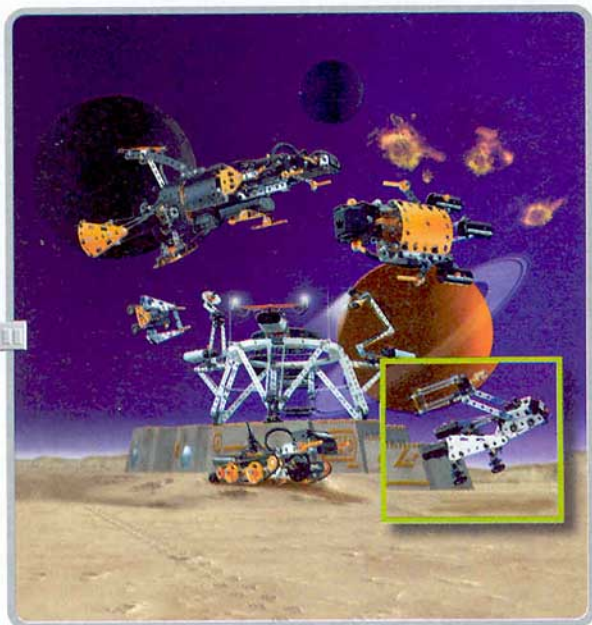
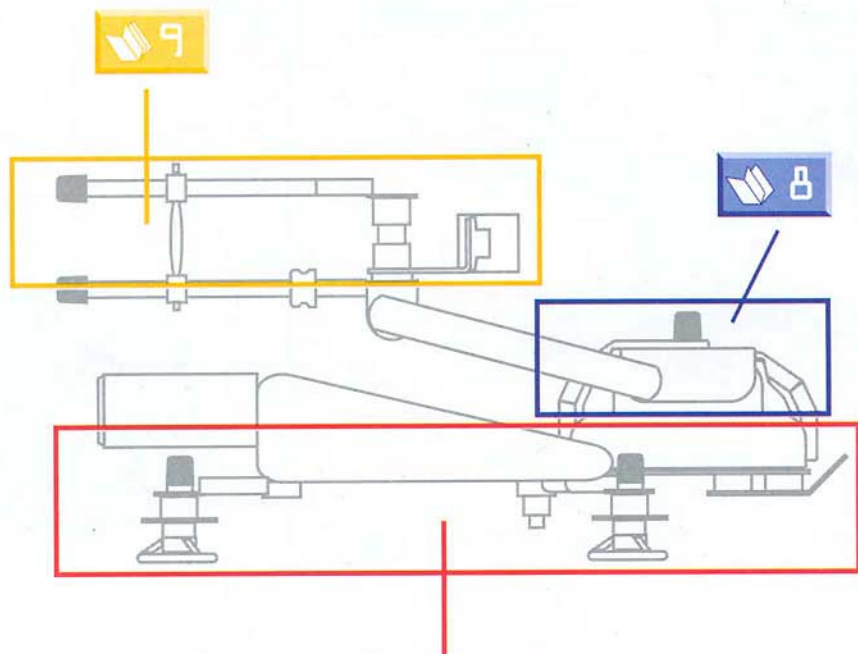

Skill Level 1	Nível 1	Taso 1
Niveau 1	Nível 1	Στάδιο 1
Livello 1	Nivå 1	レベル 1



Skill Level 2	Nível 2	Taso 2
Niveau 2	Nível 2	Στάδιο 2
Livello 2	Nivå 2	レベル 2



Skill Level 3	Nível 3	Taso 3
Niveau 3	Nível 3	Στάδιο 3
Livello 3	Nivå 3	レベル 3

Models do not fly.
 Les modèles ne volent pas.
 Modelle fliegen nicht.
 I modelli non volano.
 Los modelos no vuelan.
 De modellen vliegen niet.

Os modelos não voam.
 Modellerna flyger ej.
 Mallit eivät lennä.
 Modellerne kan ikke flyve.
 Τα μοντέλα δεν πετούν.
 実際には飛びません。

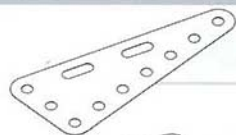

224 x2

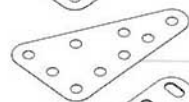

221 x2

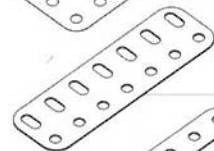

103D x1

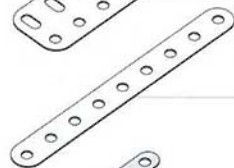

2A x2



235A x2



103H x2

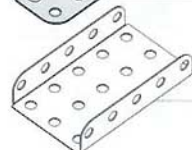

51F x1

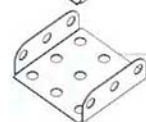

51B x1



48 x1



12C x4



812D x1



34 x1



36C x1



16B x4



17 x2



324A x2



163 x2



812B x2



142M x2



340 x1



340A x1



120E x4



111 x4



111A x5



111C x6



147G x8



111E x2



37B x2



37B x16



37A x33



37H x8



212 x8



38 x22



59A x9



38B x2



38D x4



321 x4



23C x8



184G x1



59B x1



38A x16



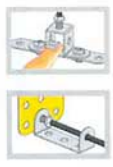

1

2

3

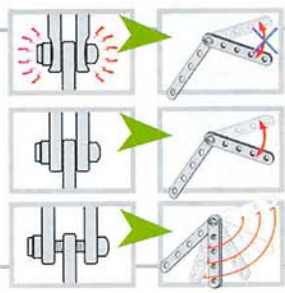

1

2

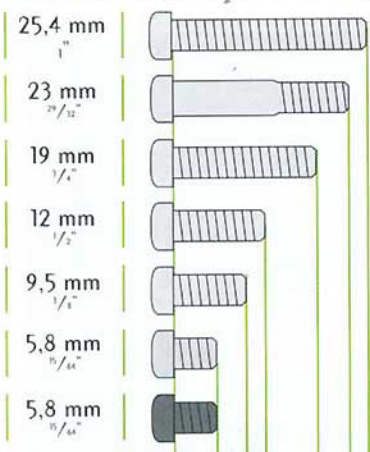

Scale
Echelle
Maßstab
Scala

Escala
Schaal
Escala
Skala

Mittakaava
Mälestok
Κλίμακα
スケール

1:1

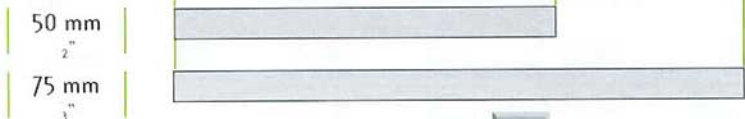
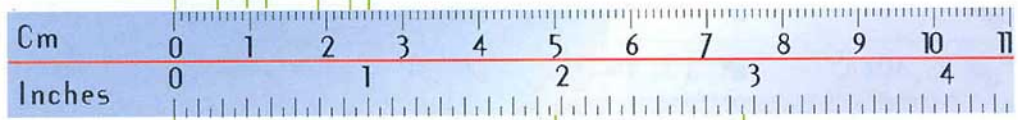

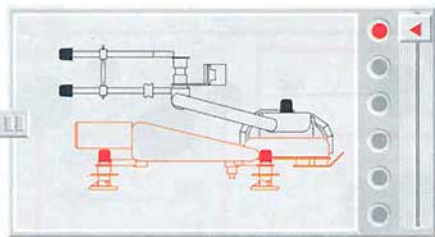

1

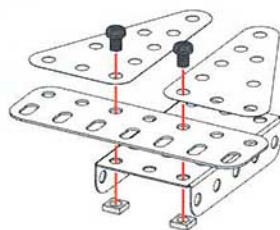
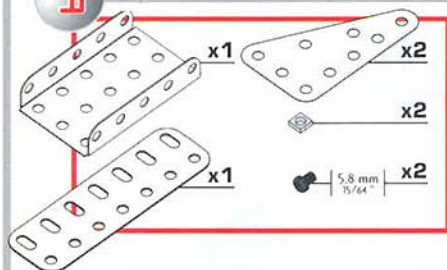

2

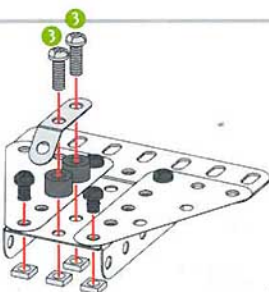
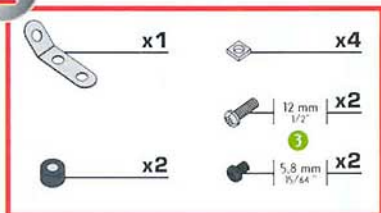

3

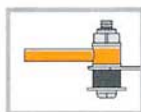
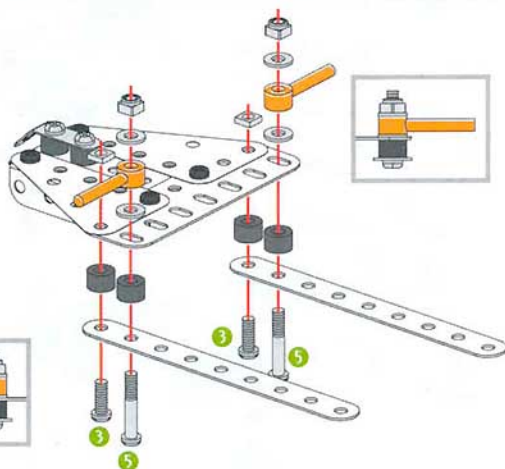
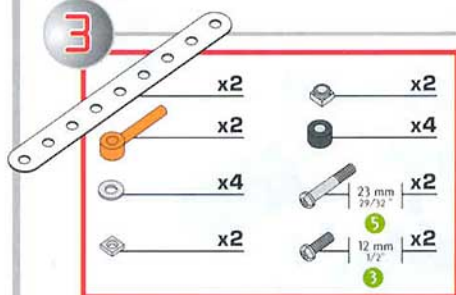

5

4

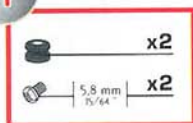

5

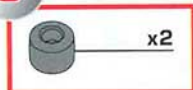

6

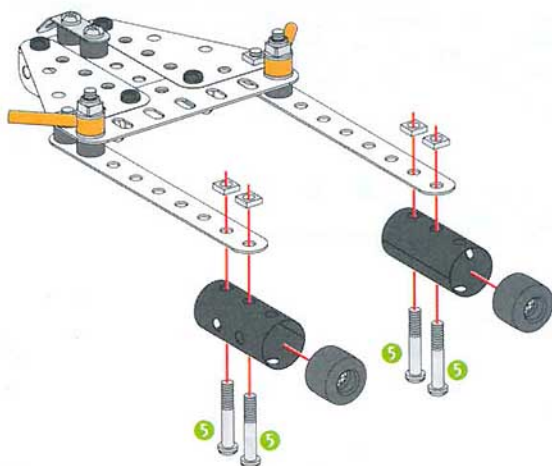

7

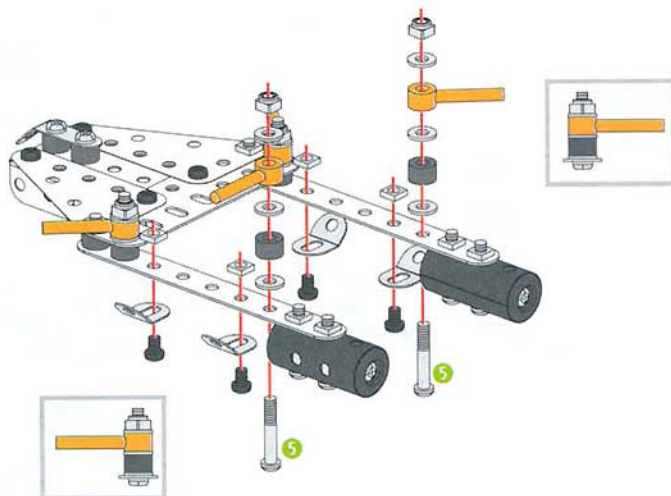
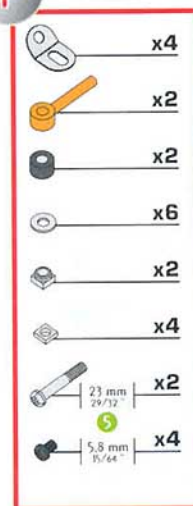

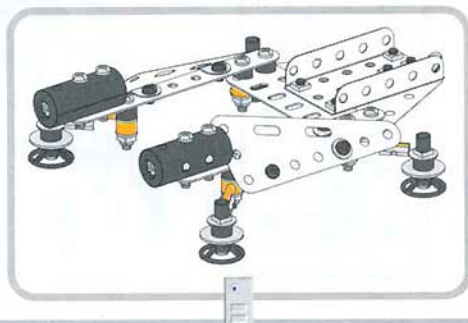
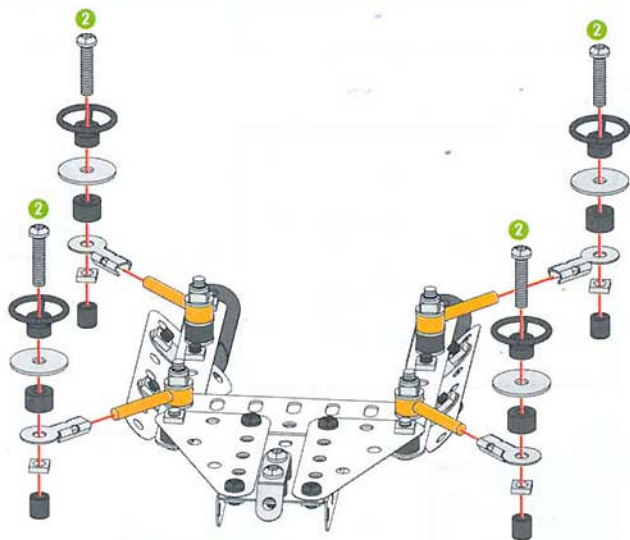
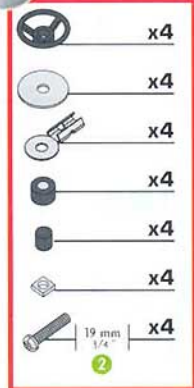
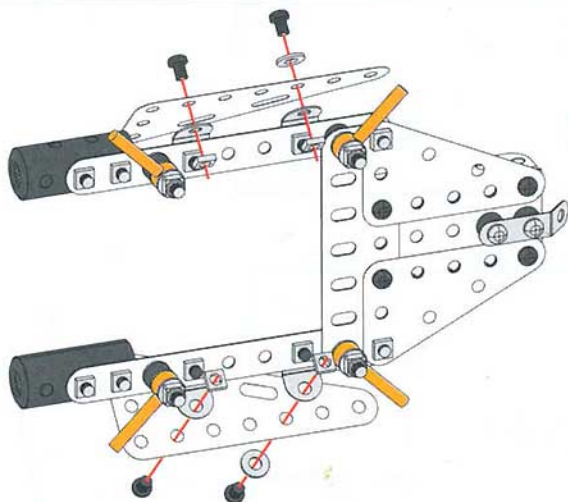
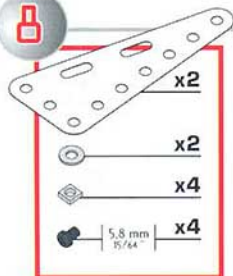

7

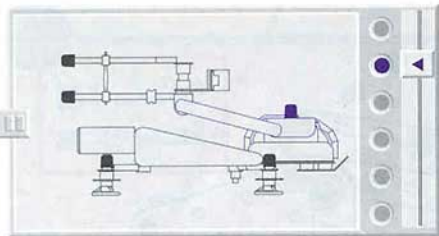
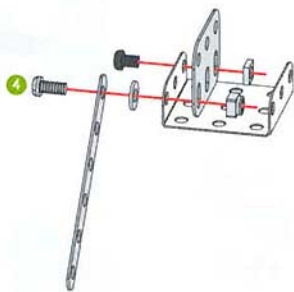
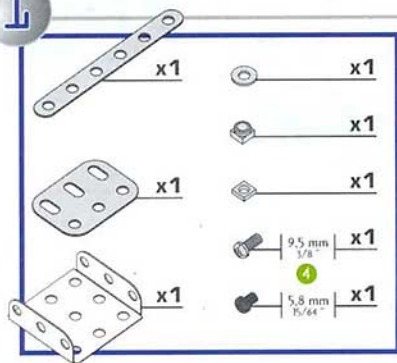
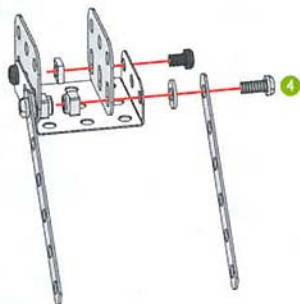
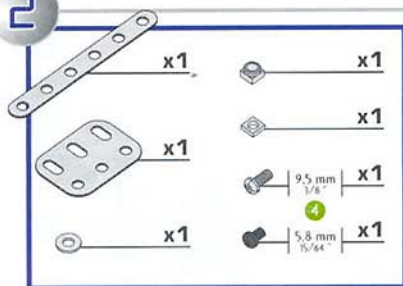
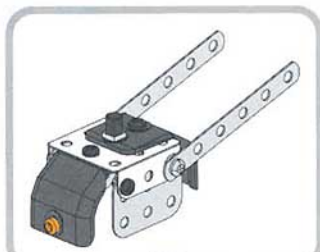
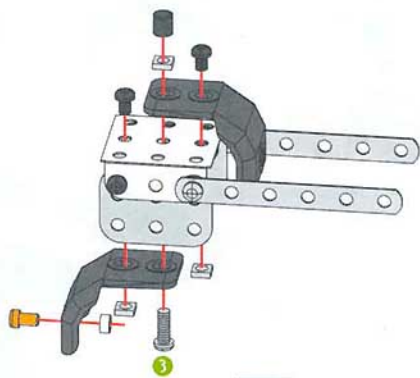
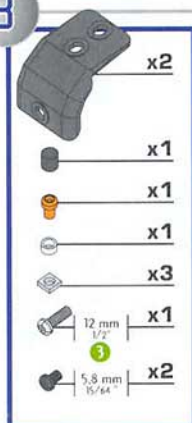
**1****2****3**

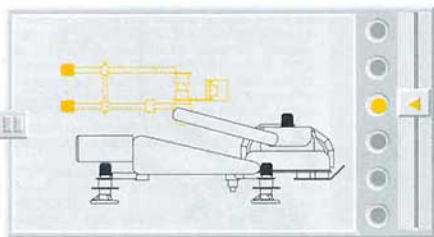

1

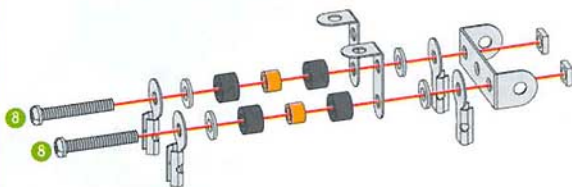
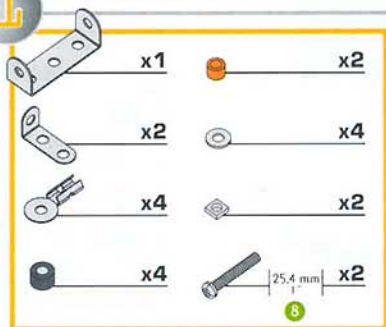

2

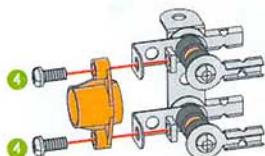
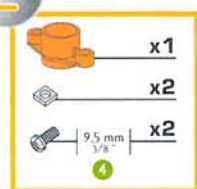



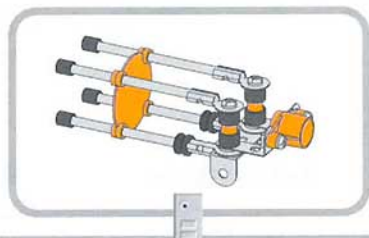
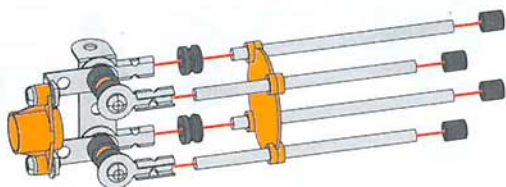
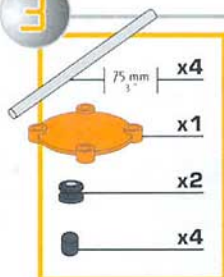

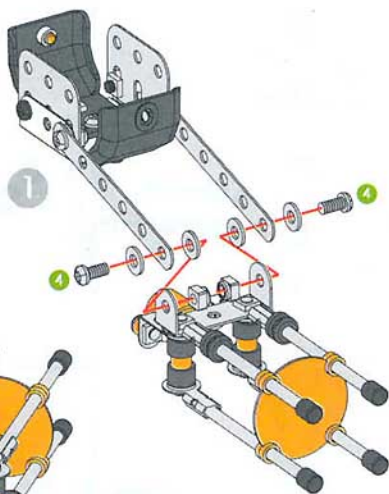
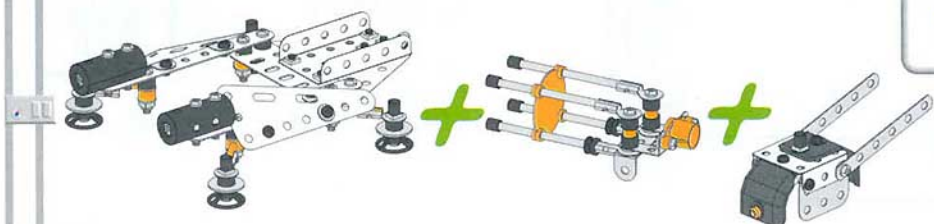

3



9





	x2
	x4
	x4
	x2
	x2



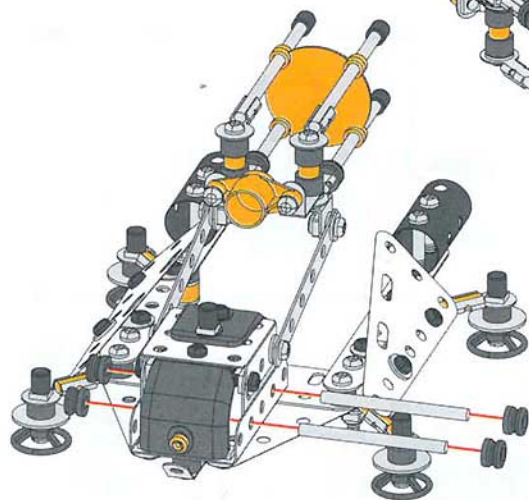
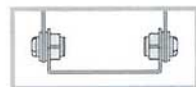

2

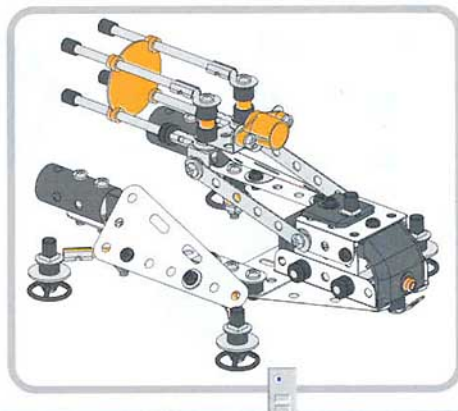

GB Many of the models and component parts are unique and original designs which are the property of MECCANO S.A. They are protected by national legislation as industrial designs, trademarks and/or copyrights throughout many countries. For detailed information, please contact MECCANO S.A. MECCANO takes no responsibility where instructions have not been followed, where pieces have been put to uses other than those in the instructions, or have been modified for another use.

F De nombreux modèles et pièces sont des créations originales, propriétés de MECCANO S.A. et sont protégés par les législations nationales sur les dessins et modèles, marques et/ou droits d'auteurs. Pour toute information, merci de contacter : MECCANO S.A. MECCANO se dégage de toutes responsabilités en cas de non-respect des indications de montage, utilisation des pièces pour un autre usage que celui indiqué dans les notices et/ou modification des pièces.

D Zahlreiche Modelle und Teile sind Erfindungen und Eigentum der Firma MECCANO S.A. Sie sind durch Inland-Gesetze über Zeichnungen und Modelle sowie Warenzeichen und/oder Urheberrechte geschützt. Für zusätzliche Auskünfte wenden Sie sich bitte an : MECCANO S.A. MECCANO kann keine Haftung übernehmen, wenn die Anleitungen nicht befolgt oder wenn Teile anders als in den Anleitungen vorgesehen eingesetzt oder abgeändert werden.

I Numerosi modelli e pezzi sono creazioni originali della MECCANO S.A. e sono protetti dalle legislazioni nazionali sui disegni e modelli, marchi e/o diritti d'autore. Per qualsiasi informazione, vogliate prendere contatto con: MECCANO S.A. MECCANO non si assume alcuna responsabilità qualora le istruzioni non vengano seguite, le parti componenti vengano impiegate in modo diverso da quanto illustrato o siano state modificate per usi differenti dal montaggio dei modelli MECCANO.

E Numerosos modelos y piezas son creaciones originales, propiedades de MECCANO S.A. y están protegidos por las legislaciones nacionales en lo que concerne a los dibujos y modelos, marcas y/o derechos de autor. Para cualquier información, sírvase ponerse en contacto con: MECCANO S.A. MECCANO no se responsabilizará en aquellos casos en que no se hayan seguido las instrucciones, las piezas se hayan usado con distinto fin al indicado en las instrucciones o bien se hayan modificado para otros usos.

NL Veel modellen en onderdelen zijn originele ontwerpen en eigendom van MECCANO S.A. en worden beschermd door de nationale wetgevingen op tekeningen en modellen, merken en/of auteursrechten. Voor informatie gelieve contact op te nemen met MECCANO S.A. MECCANO sluit elke aansprakelijkheid uit ingeval van het niet opvolgen van de montage-instructies, het gebruik van onderdelen voor andere doeleinden dan omschreven in de instructies en/of het modificeren van geleverde onderdelen.

P Vários modelos e peças são criações originais, propriedades da MECCANO S.A. e são protegidos pelas legislações nacionais relativas aos desenhos e modelos, às marcas e/ou aos direitos de autor. Para qualquer informação, é favor contactar : MECCANO S.A. A MECCANO não tem sido respeitadas, das peças serem utilizadas para outros fins que não os indicados nas instruções e/ou que tenham sido alteradas para outras utilizações.

S Många modeller och delar bildar en unik och originell formgivning vilken är MECCANO S.A. egendom. Dessa modeller och delar är skyddade genom lagstiftning såsom industriell formgivning, varumärke och/eller upphovsmannarätt i ett flertal länder. För mer detaljerad information, var vänlig och kontakta MECCANO S.A. MECCANO kan ej ta ansvar för något då instruktionerna ej har följts, då delar har använts till annat än vad instruktionerna anvisat eller att delarna har blivit modifierade till annan användning.

FIN Useat mallit ja osat ovat MECCANO S.A.:n omaisuutta olevaa suunnittelua. Useat mallit ja niiden osat ovat lailla suojattua teollista tuotantoa, tavaramerkkejä ja/tai kopiointioikeuksia useissa maissa. Tuotemerkit MECCANO on MECCANO S.A.:n omaisuutta oleva rekisteröity tavaramerkki, jonka käyttö ilman lupaa on kielletty. Lisätietoja varten, ottakaa yhteyttä MECCANO S.A. MECCANO ei ota vastuuta, jos osia on käytetty muuhun kuin ohjeiden suosittelemaan käyttötarkoitukseen tai jos osia on itse muutettu.

DK Vore mange modeller og dele er originale fremstillinger og ejes af MECCANO S.A. Tegninger, modeller, fabrikationsmærker og ophavsret er lovbeskyttede i hvert land. Yderligere oplysninger kan fås hos: MECCANO S.A. MECCANO frasiger sig ethvert ansvar såfremt montage instruktionerne ikke overholdes, hvis materialet bliver brugt til andre formål end det der står anført i instruktionerne, eller hvis der foretages ændringer af losdelene.



GR Πολλά μοντέλα και ανταλλακτικά είναι αυθεντικά, ιδιοκτησία της MECCANO A.E. και προστατεύονται από τις εθνικές νομοθεσίες για τα μοντέλα, τις μάρκες ή τα διπλώματα ευρεσιτεχνίας. Για κάθε πληροφορία παρακαλώ απευθυνθείτε στη MECCANO A.E. Η MECCANO δε φέρει καμία ευθύνη σε περίπτωση που δεν τηρηθούν οι οδηγίες συναρμολόγησης σε περίπτωση που τα συναρμολογημένα κομμάτια χρησιμοποιούνται για άλλη χρήση από εκείνη που αναφέρεται στις οδηγίες χρήσης και/ή σε περίπτωση που τροποποιηθούν.

JPN モデルならびに部品は、その多くが MECCANO 社 所有のオリジナル・デザインで、意匠・商標および/または著作権に関する国内法によって保護されています。詳細については、当社 (MECCANO S.A.) までお問い合わせ願います。指定の組立方法に従わない場合や説明書にない用途に部品を用いた場合、また部品を改造した場合、MECCANO 社はその責任を一切負いません。

USA Many models and component parts incorporate original designs which are the property of MECCANO S.A. and are protected as design and/or utility patent and/or copyrights. For detailed information, please contact MECCANO S.A. Instruction booklets are solely to assist in construction of sets. MECCANO, Inc. shall have no responsibility for:

1. Failure to follow instructions.
2. Use of parts for any purpose other than as specified in the instruction booklets.
3. Any alteration of any parts or components.

Made in France by:
Fabriqué en France par : Meccano S.A. 363, avenue de Saint-Exupéry - F - 62100 CALAIS
Hecho en Francia :

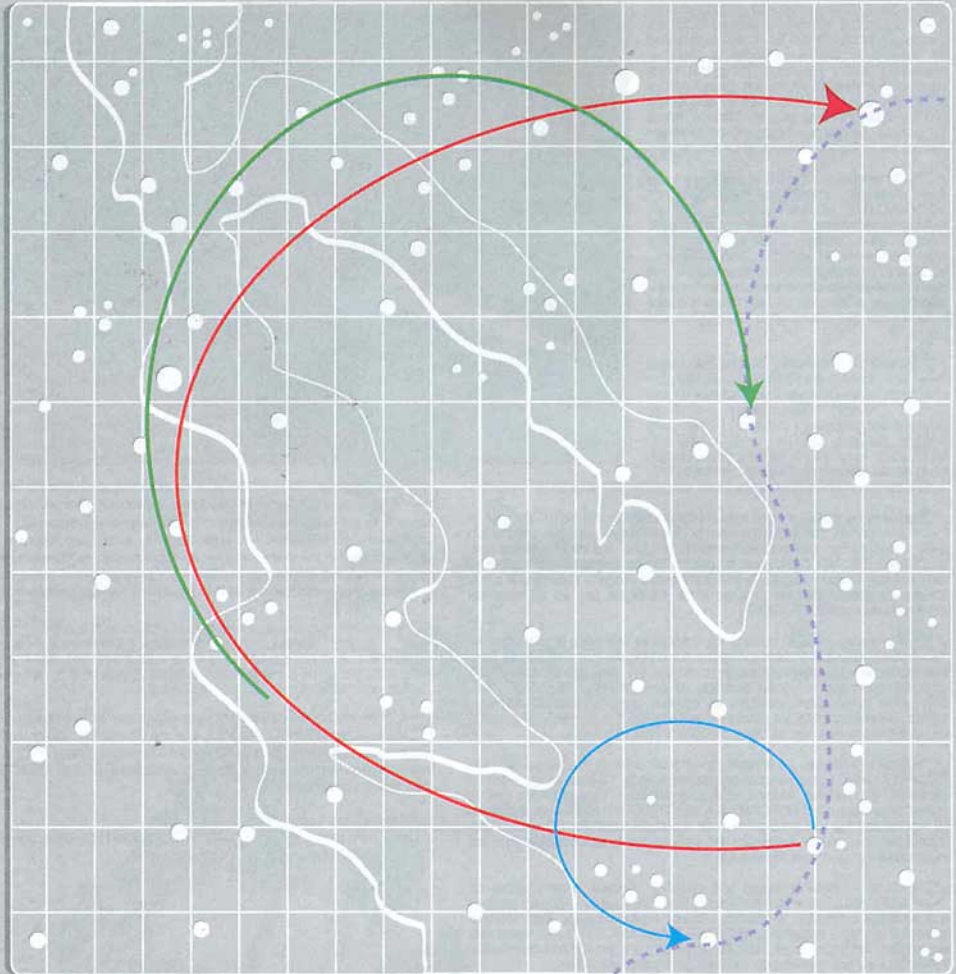

MECCANO