

INSTRUCTION LOG BOOK

LIVRO DE BORDO PARA MONTAGEM

CARNET DE BORD DE MONTAGE

MONTERINGS PROTOKOLL

BAUANLEITUNG

ASENNUKSEN LOKIKIRJA

LIBRETTO DI BORDO PER IL MONTAGGIO

MONTAGE HÆFTE

DIARIO DE A BORDO DE MONTAJE

ΣΗΜΕΙΩΜΑΤΑΡΙΟ ΣΥΝΑΡΜΟΛΟΓΗΣΗΣ

MONTAGEDAGBOEK

組み立て説明書

1 2

3 4

5 6

7 8

9 0

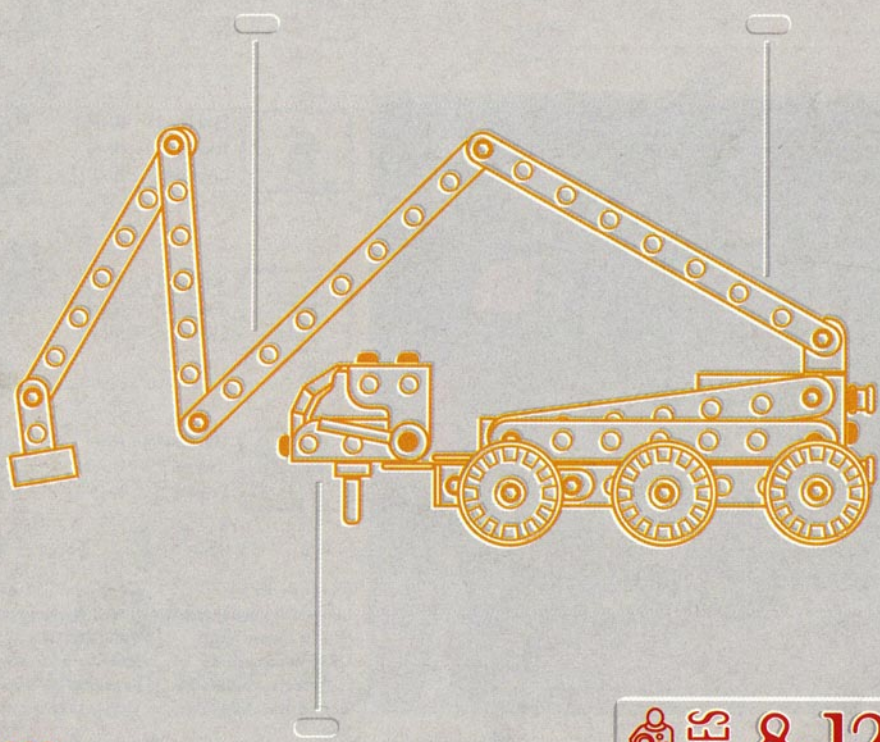

4820

 AGES 8-12



5

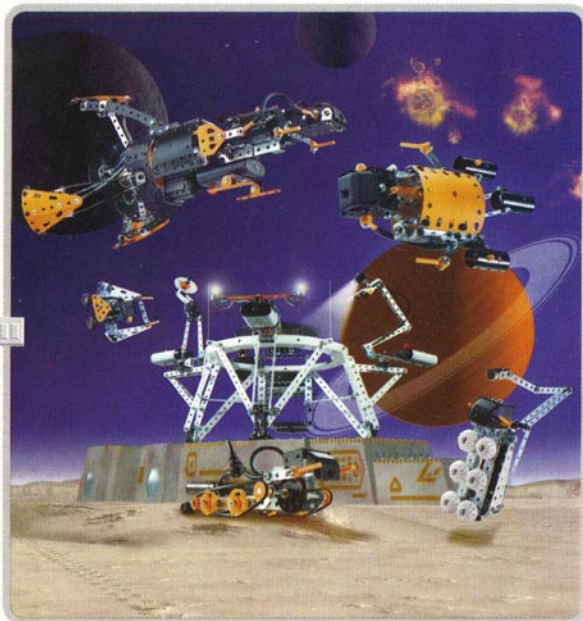
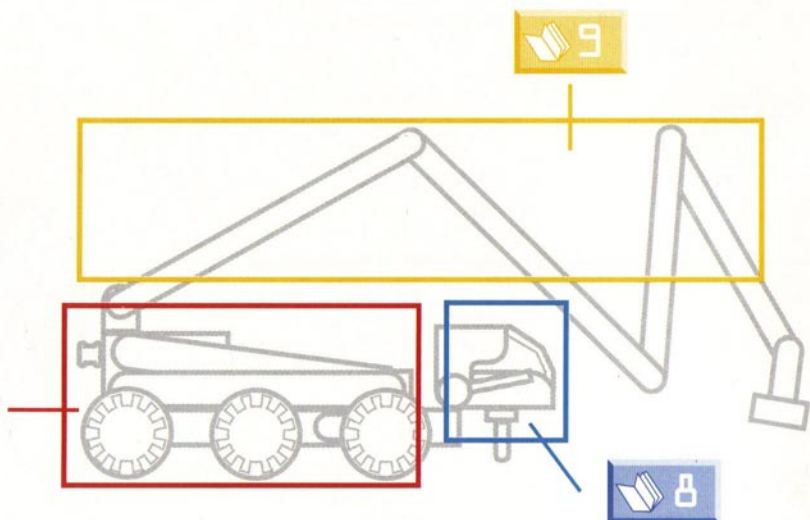

Skill Level 1 Nivel 1
Niveau 1 Nível 1
Livello 1 Nivà 1

Taso 1
Στάδιο 1
レベル



Skill Level 2 Nivel 2
Niveau 2 Nível 2
Livello 2 Nivà 2

Taso 2
Στάδιο 2
レベル 2



Skill Level 3 Nivel 3
Niveau 3 Nível 3
Livello 3 Nivà 3

Taso 3
Στάδιο 3
レベル 3

Models do not fly.
Les modèles ne volent pas.
Modelle fliegen nicht.
I modelli non volano.
Los modelos no vuelan.
De modellen vliegen niet.

Os modelos não voam.
Modellerna flyger ej.
Mallit eivät lennä.
Modellerne kan ikke flyve.
Τα μοντέλα δεν πετούν.
実際には飛びません。

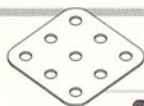

74 x1

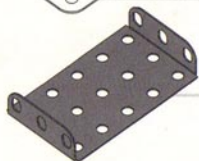

51 x1



51B x2



51D x1

324A x1



48B x2

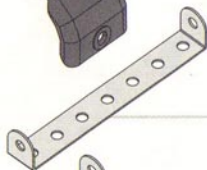

48 x1



48E x1



9F x1



811A x1



12 x2



34 x1



36C x1



114 x1



154A x1



154B x1



3 x4



5 x1



10 x4

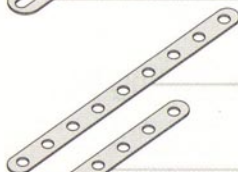

235D x4



235B x3



235G x2

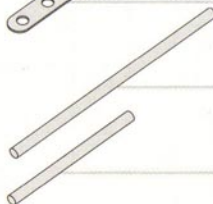

15B x2

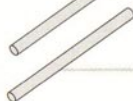

16A x1



111D x1



147F x1



37A x41

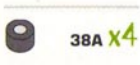

38A x4



184G x3



111A x2



147D x1



37H x8



38B x5



59B x3



111C x1

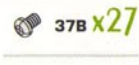

37B x27

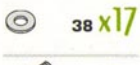

38 x17



23C x6



120E x2



147G x6

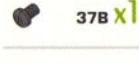

37B x1



115 x2



59A x2

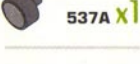

537A x1



43 x1



187F x6

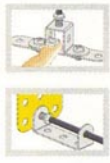
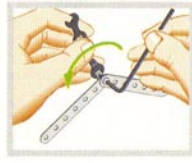
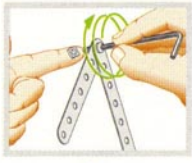
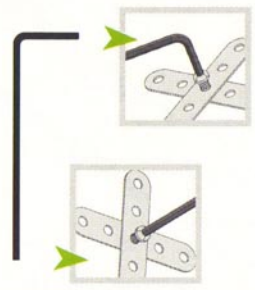

1

2

3

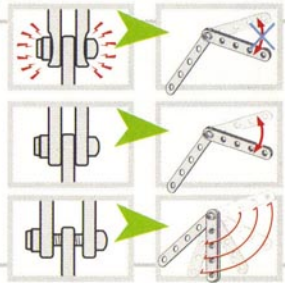
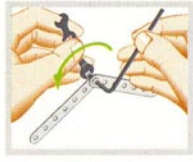
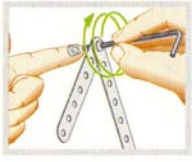

1

2

28 mm

1 1/8"

23 mm

7/8"

19 mm

3/4"

14,7 mm

1/2"

12 mm

1/2"

9,5 mm

3/8"

5,8 mm

9/16"

5,8 mm

9/16"

Scale
Echelle
Maßstab
Scala

Escala
Schaal
Escala
Skala

Mittakaava
Μέτρο
Κλίμακα
スケール

1:1



Cm

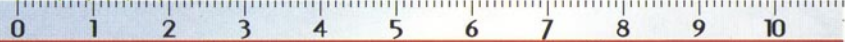

Inches

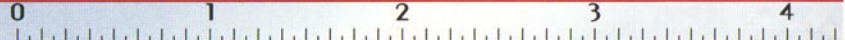

60 mm

2 1/2"

100 mm

4"



4

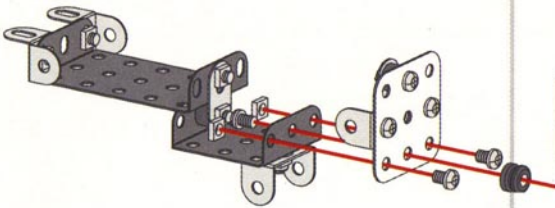

5

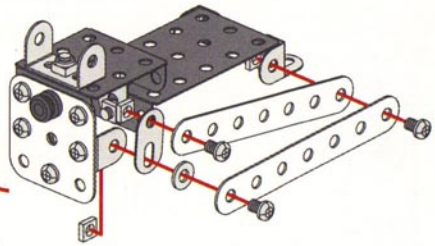
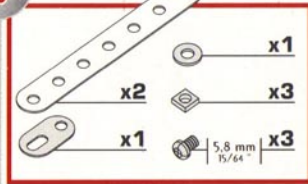

6

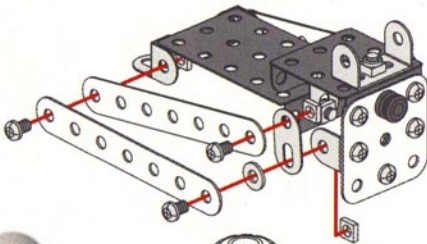
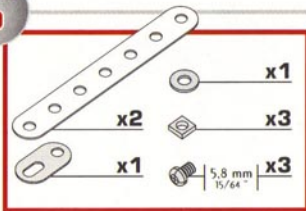

7

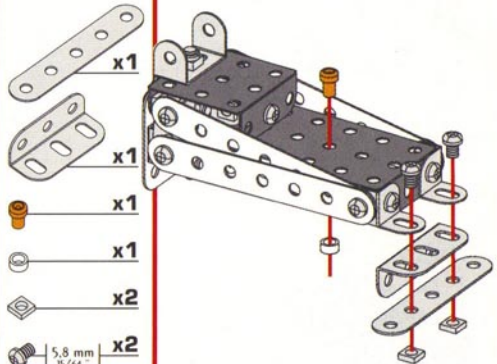
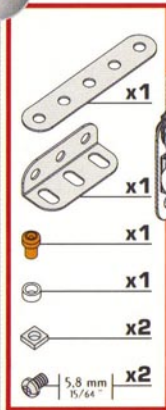

8

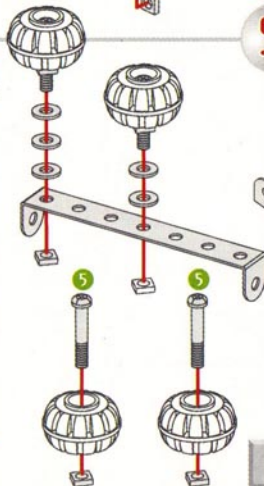
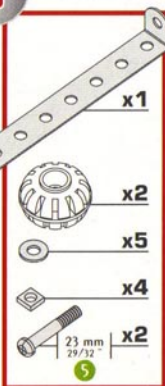

9

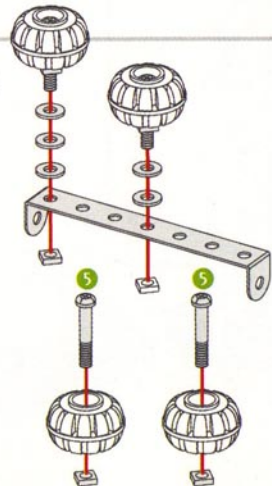
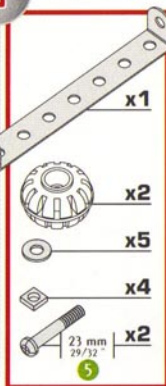

6

10

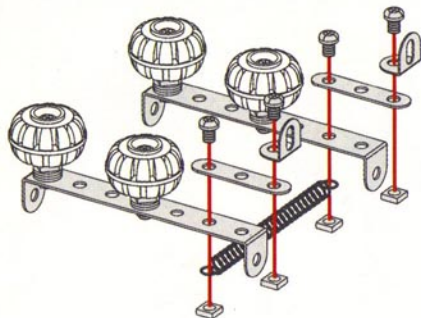
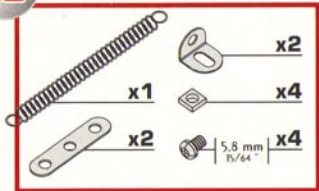

11

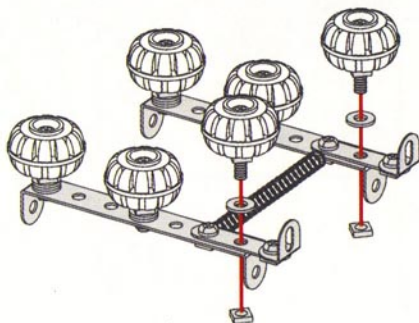
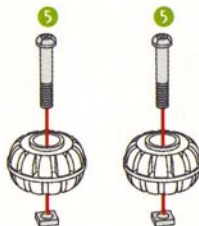

12

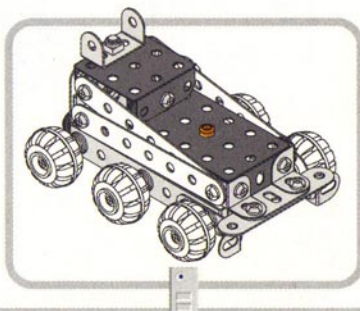
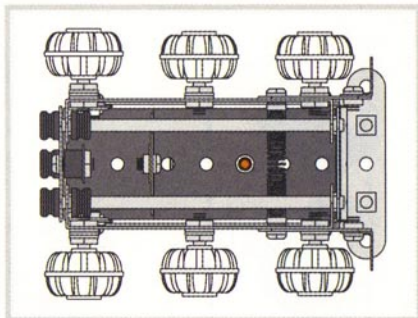
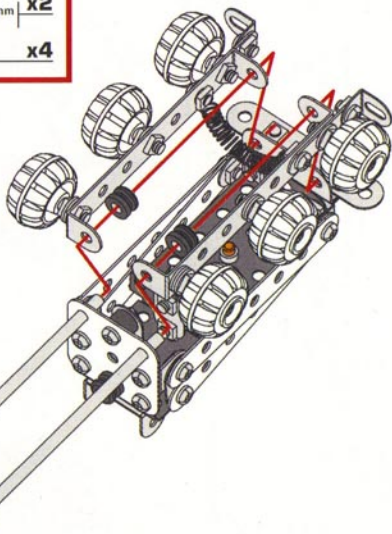

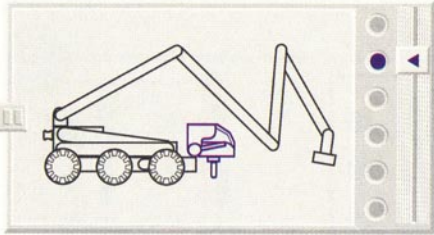

1

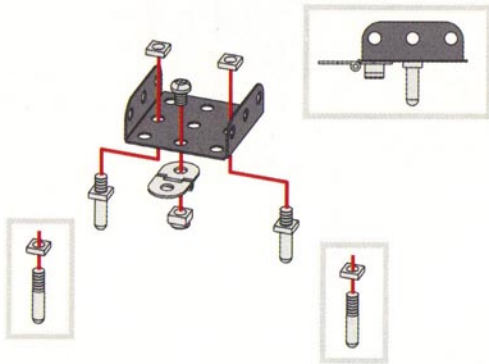
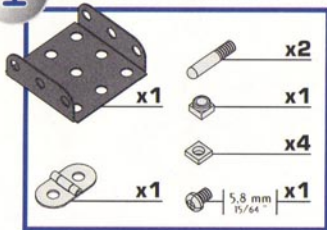

2

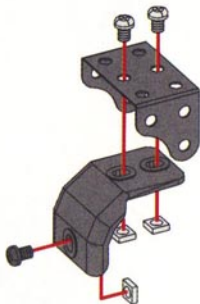
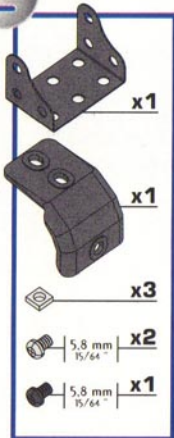



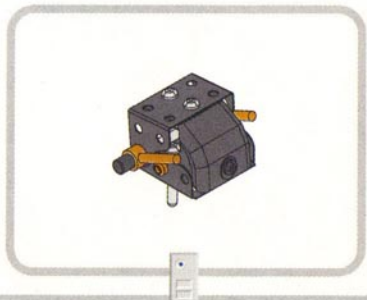
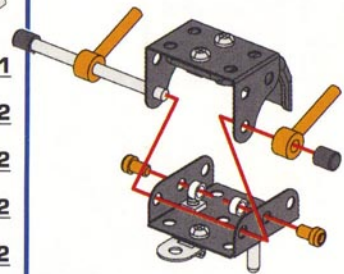
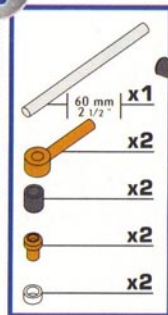

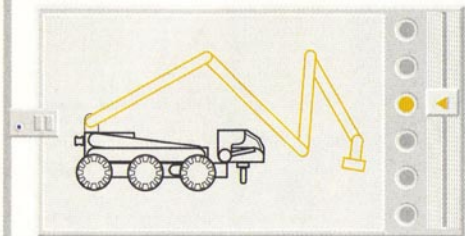

3

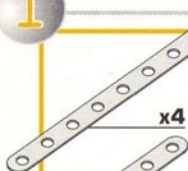
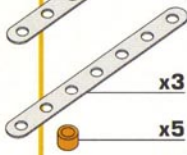







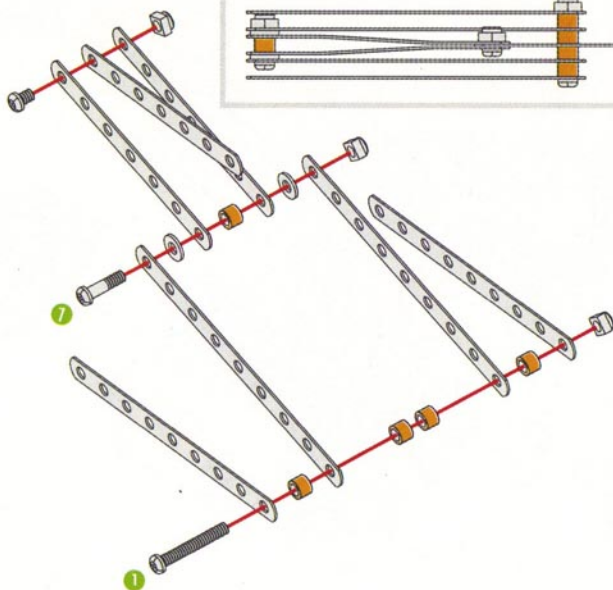

1

-  x4
-  x3
-  x5
-  x2
-  x3
-  28 mm | $\frac{1}{4}$ " x1
-  14,7 mm | $\frac{9}{16}$ " x1
-  5,8 mm | $\frac{5}{64}$ " x1



2

-  x1
-  x1
-  x1
-  x2
-  x1
-  19 mm | $\frac{3}{4}$ " x1

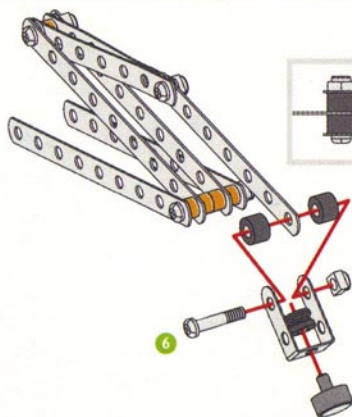

9

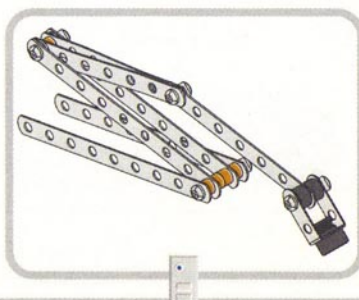

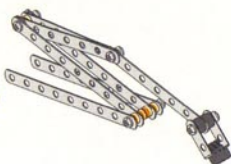
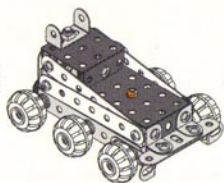

 x2

 x1

 5,8 mm | 15/64" x3

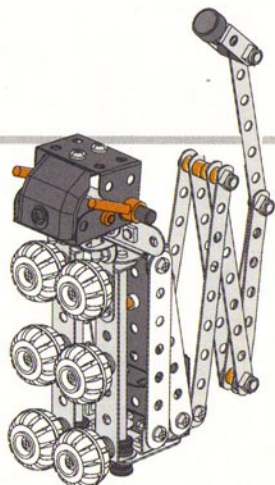
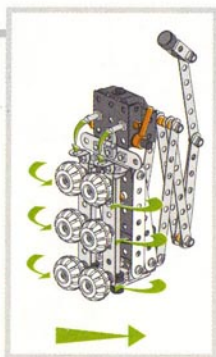
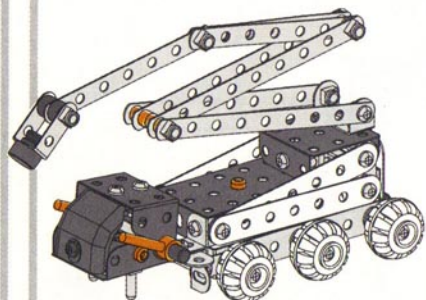
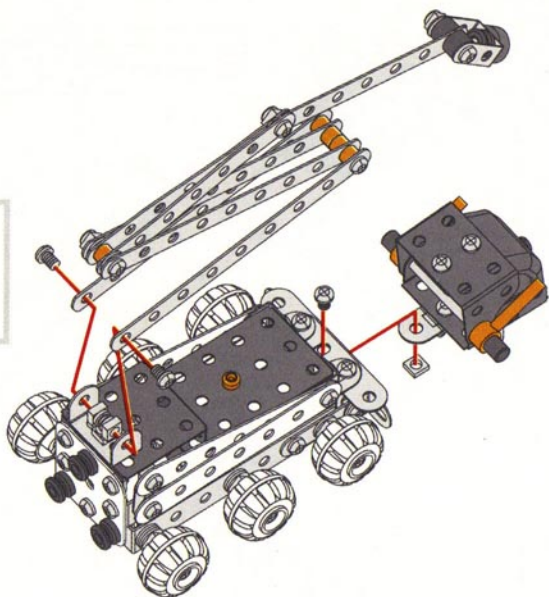
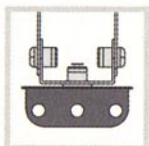

(GB) Many of the models and component parts are unique and original designs which are the property of MECCANO S.A. They are protected by national legislation as industrial designs, trademarks and/or copyrights throughout many countries. For detailed information, please contact MECCANO S.A. MECCANO takes no responsibility where instructions have not been followed, where pieces have been put to uses other than those in the instructions, or have been modified for another use.

(F) De nombreux modèles et pièces sont des créations originales, propriétés de MECCANO S.A. et sont protégés par les législations nationales sur les dessins et modèles, marques et/ou droits d'auteurs. Pour toute information, merci de contacter : MECCANO S.A. MECCANO se dégage de toutes responsabilités en cas de non-respect des indications de montage, utilisation des pièces pour un autre usage que celui indiqué dans les notices et/ou modification des pièces.

(D) Zahlreiche Modelle und Teile sind Erfindungen und Eigentum der Firma MECCANO S.A. Sie sind durch Inland-Gesetze über Zeichnungen und Modelle sowie Warenzeichen und/oder Urheberrechte geschützt. Für zusätzliche Auskünfte wenden Sie sich bitte an : MECCANO S.A. MECCANO kann keine Haftung übernehmen, wenn die Anleitungen nicht befolgt oder wenn Teile anders als in den Anleitungen vorgesehen eingesetzt oder abgeändert werden.

(I) Numerosi modelli e pezzi sono creazioni originali della MECCANO S.A. e sono protetti dalle legislazioni nazionali sui disegni e modelli, marche e diritti d'autore. Per qualsiasi informazione, vogliate prendere contatto con: MECCANO S.A. MECCANO non si assume alcuna responsabilità qualora le istruzioni non vengano seguite, le parti componenti vengano impiegate in modo diverso da quanto illustrato o siano state modificate per usi differenti dal montaggio dei modelli MECCANO.

(E) Numerosos modelos y piezas son creaciones originales, propiedades de MECCANO S.A. y están protegidos por las legislaciones nacionales en lo que concierne a los dibujos y modelos, marcas y/o derechos de autor. Para cualquier información, sírvase ponerse en contacto con: MECCANO S.A. MECCANO no se responsabilizará en aquellos casos en que no se hayan seguido las instrucciones, las piezas se hayan usado con distinto fin al indicado en las instrucciones o bien se hayan modificado para otros usos.

(NL) Veel modellen en onderdelen zijn originele ontwerpen in eigendom van MECCANO S.A. en worden beschermd door de nationale wetgevingen op tekeningen en modellen, merken en/of auteursrechten. Voor informatie gelieve contact op te nemen met MECCANO S.A. MECCANO sluit elke aansprakelijkheid uit ingeval van het niet opvolgen van de montage-instructies, het gebruik van onderdelen voor andere doeleinden dan omschreven in de instructies en/of het modificeren van geleverde onderdelen.

(P) Vários modelos e peças são criações originais, propriedades da MECCANO S.A. e são protegidos pelas legislações nacionais relativas aos desenhos e modelos, às marcas e/ou aos direitos de autor. Para qualquer informação, é favor contactar : MECCANO S.A. A MECCANO não tem sido respeitada, das peças serem utilizadas para outros fins que não os indicados nas instruções e/ou que tenham sido alteradas para outras utilizações.

(S) Många modeller och delar bildar en unik och originell formgivning vilken är MECCANO S.A. egendom. Dessa modeller och delar är skyddade genom lagstiftning såsom industriell formgivning, varumärke och/eller upphovsmannarätt i ett flertal länder. För mer detaljerad information, var vänlig och kontakta MECCANO S.A. MECCANO kan ej ta ansvar för något då instruktionerna ej har följts, då delar har använts till annat än vad instruktionerna anvisat eller att delarna har blivit modifierade till annan användning.

(FIN) Useat mallit ja osat ovat MECCANO S.A.:n omaisuutta olevaa suunnittelua. Useat mallit ja niiden osat ovat lailla suojattua teollista tuotantoa, tavaramerkkejä ja/tai kopiointioikeuksia useissa maissa. Tuotemerkki MECCANO on MECCANO S.A.:n omaisuutta oleva rekisteröity tavaramerkki, jonka käyttö ilman lupaa on kielletty. Lisätietoja varten, ottakaa yhteyttä MECCANO S.A. MECCANO ei ota vastuuta, jos osia on käytetty muuhun kuin ohjeiden suosittelemaan käyttöä/tarkoitukseen tai jos osia on itse muutettu.

(DK) Vore mange modeller og dele er originale fremstillinger og ejes af MECCANO S.A. Tegninger, modeller, fabrikationsmærker og ophavsret er lovbeskyttede i hvert land. Yderligere oplysninger kan fås hos: MECCANO S.A. MECCANO fræsiger sig ethvert ansvar såfremt montage instruktionerne ikke overholdes, hvis materialet bliver brugt til andre formål end det der står anført i instruktionerne, eller hvis der foretages ændringer af lasedelen.

(GR) Πολλά μοντέλα και ανταλλακτικά είναι αυθεντικά, ιδιοκτησία της MECCANO A.E. και προστατεύονται από τις εθνικές νομοθεσίες για τα μοντέλα, τις μάρκες ή τα διπλώματα ευρεσιτεχνίας. Για κάθε πληροφορία παρακαλώ απευθυνθείτε στη MECCANO A.E.. Η MECCANO δε φέρει καμία ευθύνη σε περίπτωση που δεν τηρηθούν οι οδηγίες συναρμολόγησης, σε περίπτωση που τα συναρμολογούμενα κομμάτια χρησιμοποιούνται για άλλη χρήση από εκείνη που αναφέρεται στις οδηγίες χρήσης και/σε περίπτωση που τροποποιηθούν.

(JPN) モデルならびに部品は、その多くが MECCANO 社 所有のオリジナル・デザインで、意匠・商標および/または著作権に関する国内法によって保護されています。詳細については、当社 (MECCANO S.A.) までお問い合わせ願います。指定の組立方法に従わない場合や説明書にない用途に部品を用いた場合、また部品を改造した場合、MECCANO 社はその責任を一切負いません。

(USA) Many models and component parts incorporate original designs which are the property of MECCANO S.A. and are protected as design and/or utility patent and/or copyrights. For detailed information, please contact MECCANO S.A. Instruction booklets are solely to assist in construction of sets. MECCANO, Inc. shall have no responsibility for:
1. Failure to follow instructions.
2. Use of parts for any purpose other than as specified in the instruction booklets.
3. Any alteration of any parts or components.

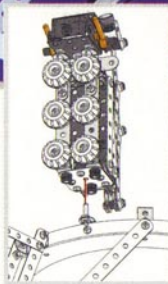
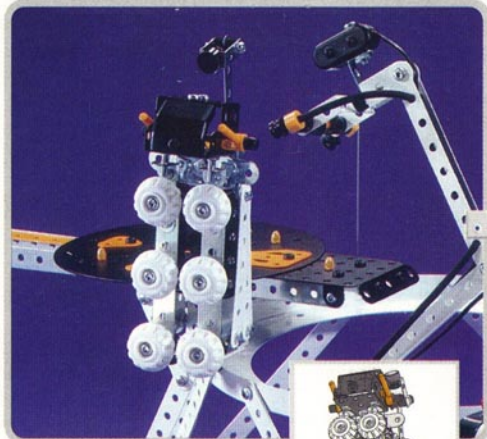
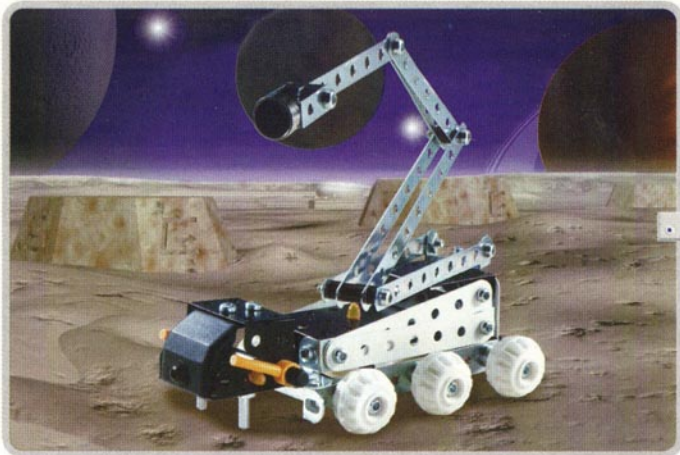

Distributed in the U.S.A.
by Meccano, Inc.
15 East 26th Street,
Suite 1617
New York, NY 10010

**QUESTIONS ABOUT YOUR
ERECTOR® SET?
CALL CUSTOMER SERVICE TOLL-FREE
AT 1-888-4-ERECTOR, EXT. 105
MONDAY THRU FRIDAY
9 A.M. - 6 P.M. E.S.T.
WE'RE HERE TO HELP!**

Made in France by: / Fabriqué en France par: / Hecho en Francia:
Meccano S.A. 363, avenue de Saint-Exupéry - 62100 CALAIS - France

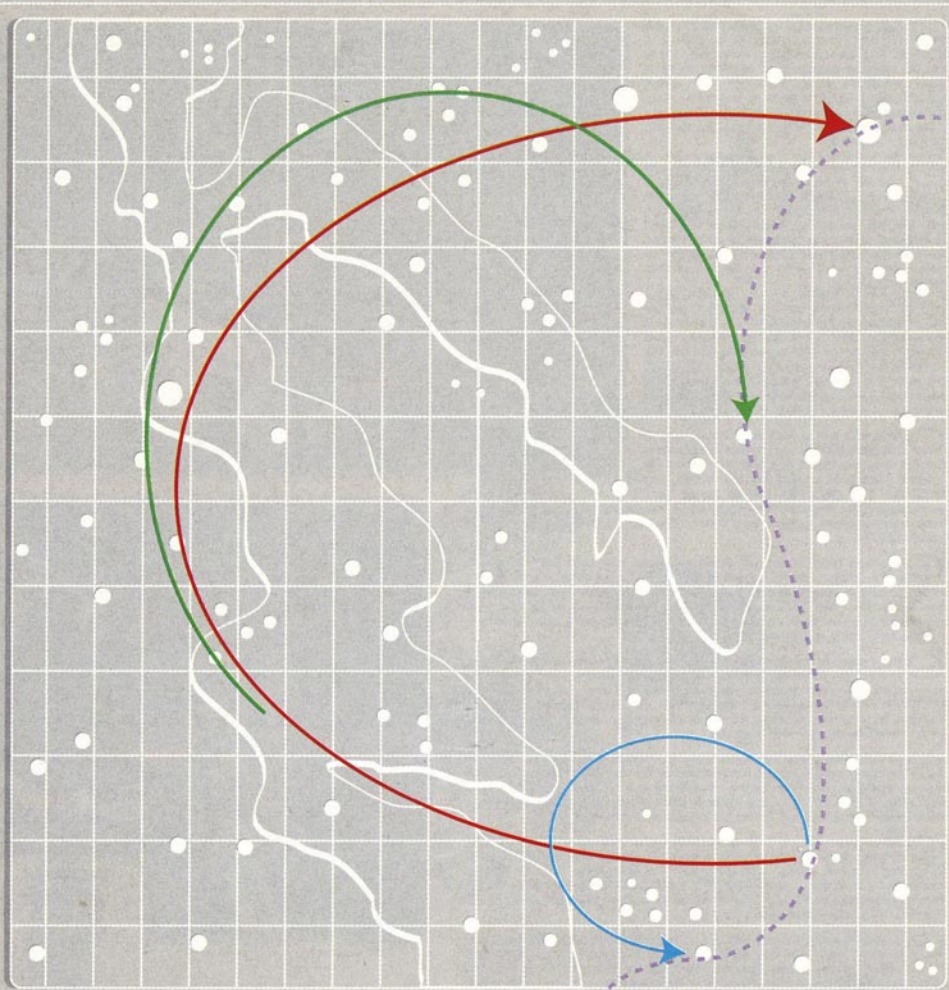

MECCANO