

# Pocket

## MIECCANO®

Instruction leaflet

Manuel d'instructions

Anleitungsbroschüre

Handleiding

Volantino con istruzioni

Instruksjonshefte





## **A pocketful of fun anytime, anywhere**

This fantastic little set contains enough parts to make lots of exciting models. This folder shows how to make 25—but you can, of course, invent many more as well! Pocket Meccano fits snugly into your pocket—so it's fun to have around all the time!

## **Votre jeu de poche Meccano**

Ce jeu remarquablement petit contient suffisamment de pièces pour accomplir de multiples constructions. Ce dépliant vous en indique 25—mais vous pouvez bien sûr en inventer bien davantage! Le jeu de poche Meccano se glisse facilement dans votre poche—et quelle joie de l'avoir sur soi tout le temps!

## **Eine tasche voller spass jederzeit, überall**

Diese fantastische kleine Anlage

enthält genug Teile, um viele aufregende Modelle herzustellen. Diese Broschüre zeigt Ihnen, wie man 25 zusammenstellen kann—aber Sie können natürlich außerdem noch viele andere erfinden! Taschen-Meccano paßt bequem in Ihre Tasche—und es macht daher Spaß, es jederzeit bei sich zu haben!

## **Een doos vol genoeg in zakformaat**

Deze fantastische set bevat voldoende onderdelen om vele prachtige modellen te kunnen bouwen. In deze brochure zijn 25 voorbeelden afgebeeld, maar natuurlijk kun je zelf nog meer modellen bedenken. 'Pocket Meccano' (Meccano in zakformaat) kun je gemakkelijk in je zak steken, zodat je het overal mee heen kunt nemen.

## **Un divertimento illimitato, ovunque**

Questa fantastica piccola scatola annovera un numero sufficiente di componenti per costruire innumerevoli eccitanti modelli. Il presente manuale fornisce suggerimenti per costruire 25 modelli, ovviamente, potrete inventarne parecchi altri voi stessi. Con la scatola Meccano tascabile, potrete divertirvi in qualsiasi momento.

## **En lommefull av moro når som helst, hvor som helst**

Dette utrolige, vesle settet inneholder nok deler til å lage mangfoldige spennende modeller. Dette heftet beskriver hvorledes du kan lage 25—men du kanselvsagt finne på mange andre i tillegg! Lomme-Meccano passer lett ned i lommen—lett og morsomt å ha det for hånden hele tiden!



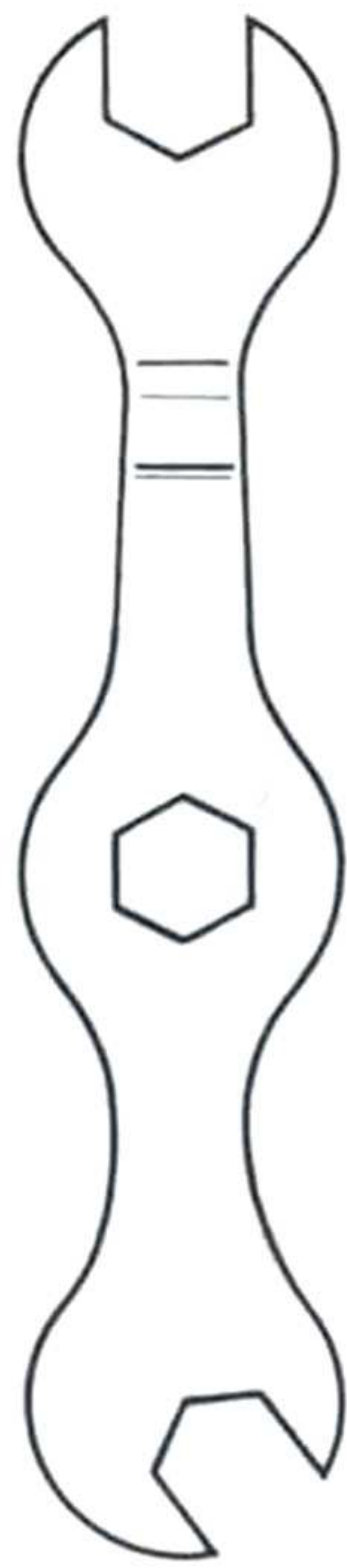

34c-SPANNER

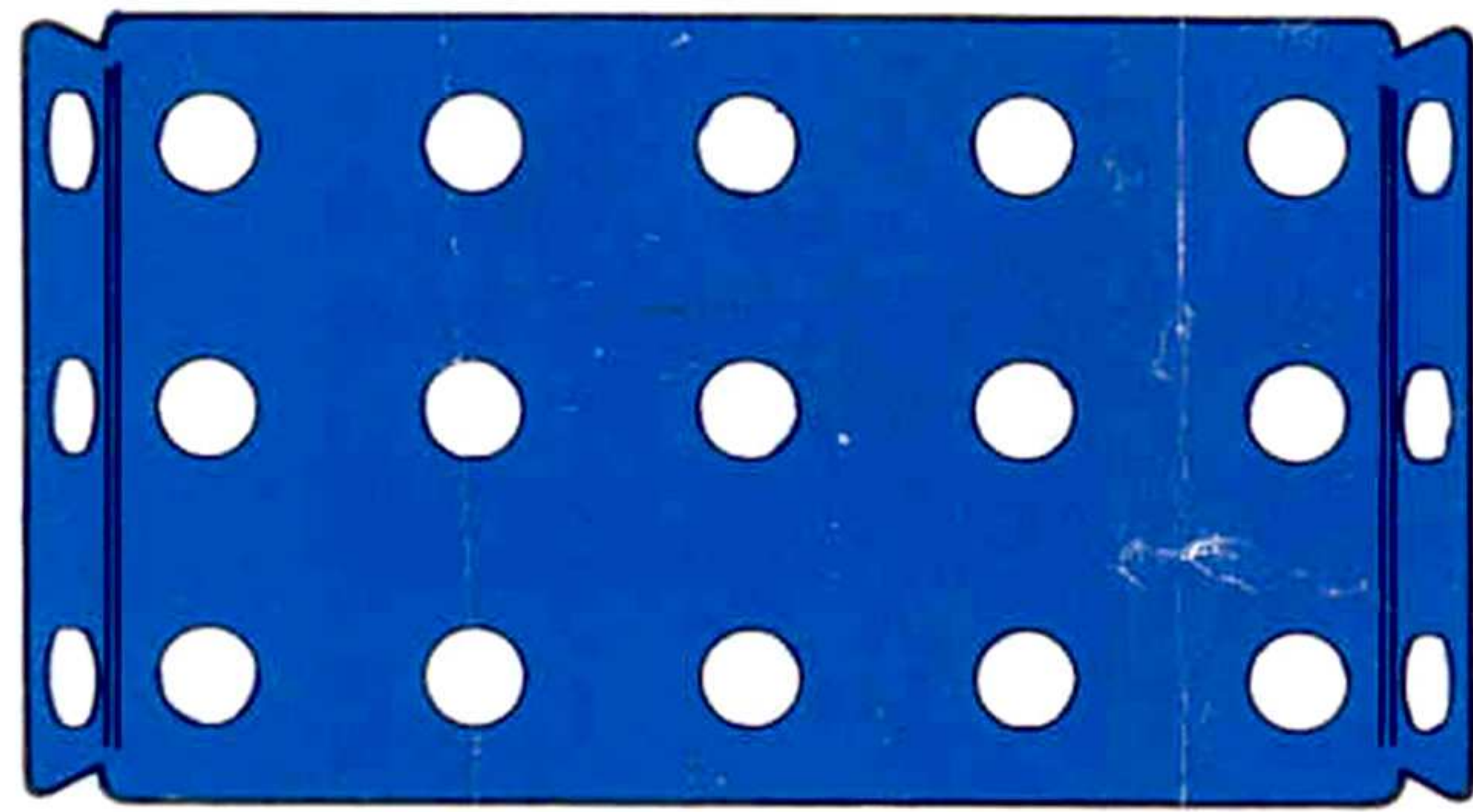

51-FLANGED PLATE 60 × 38 mm. (2½" × 1½")

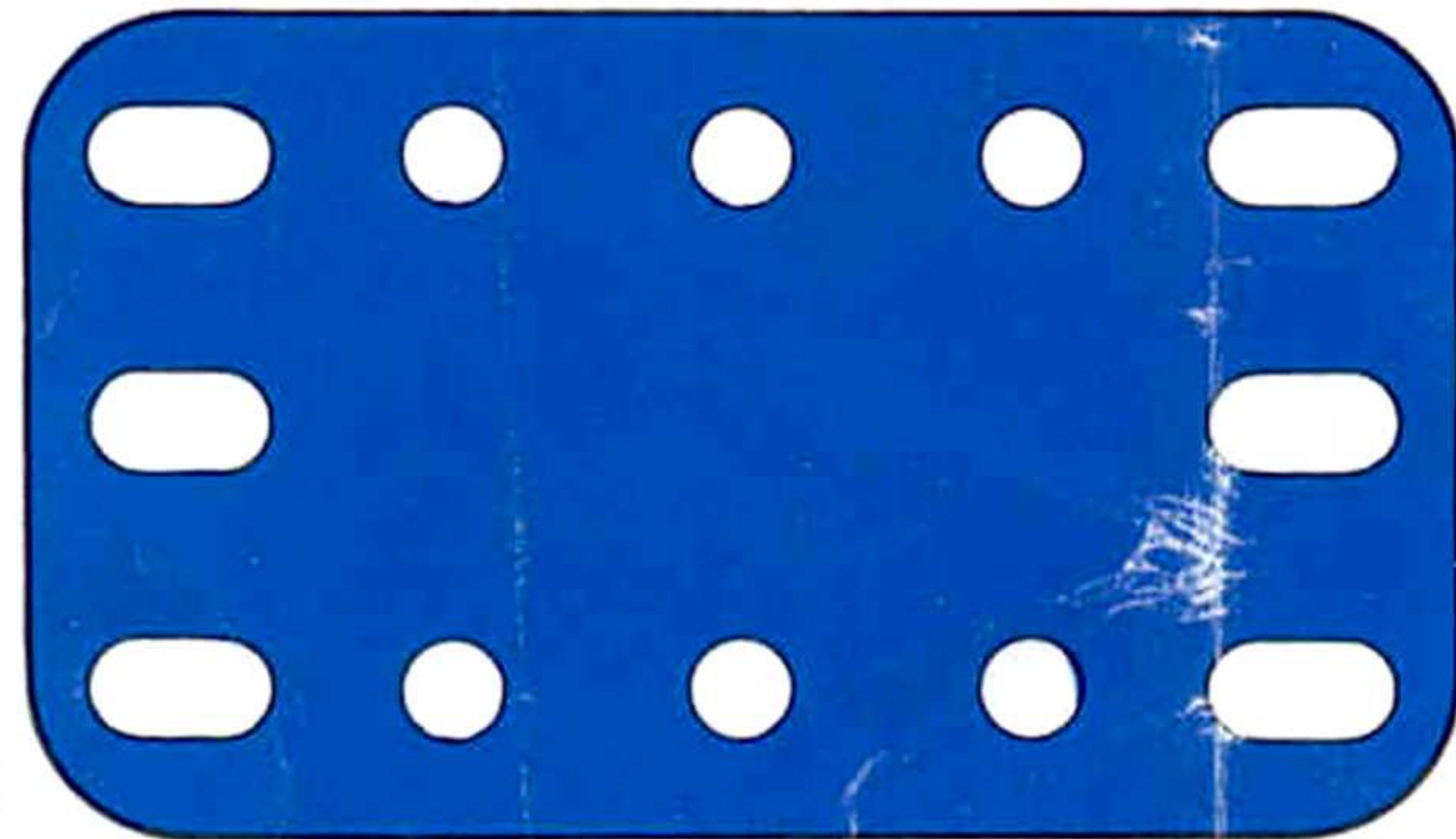

194-PLASTIC PLATE 60 × 38 mm. (2½" × 1½")

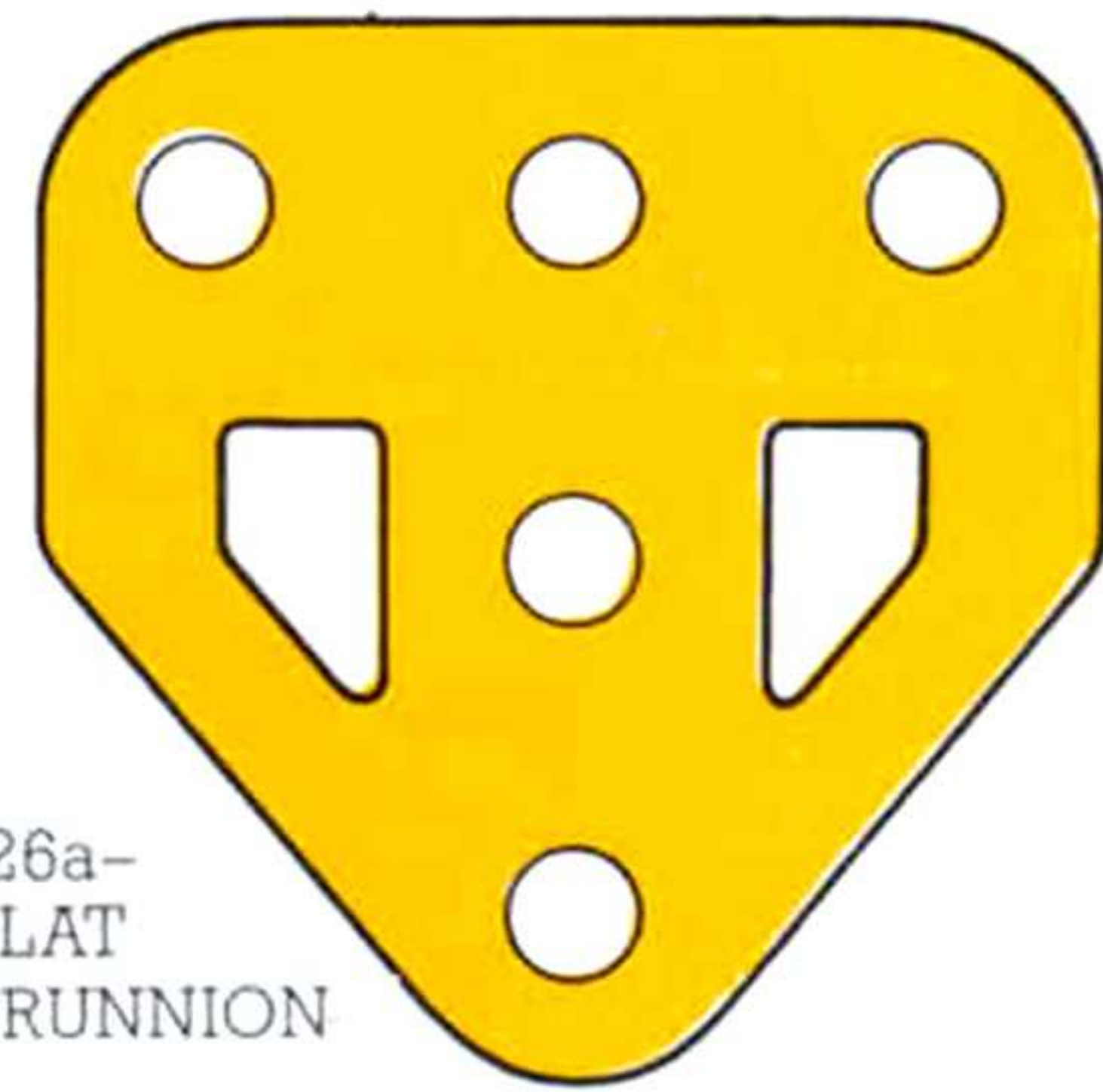

126a-  
FLAT  
TRUNNION



34a-SPANNER/  
SCREWDRIVER



12-  
ANGLE BRACKET  
12 × 12 mm. (½" × ½")



125-REVERSED  
ANGLE BRACKET  
12 mm. (½")



23-PLASTIC  
PULLEY 12 mm. (½")

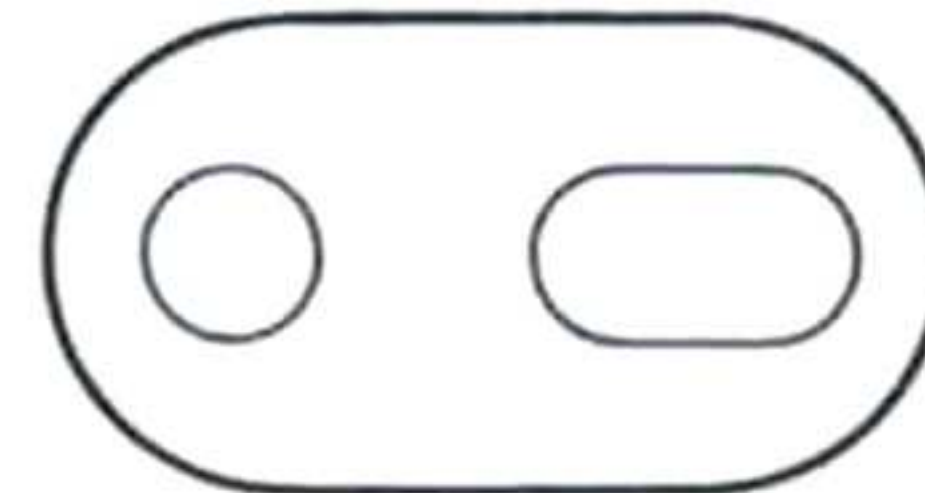

10-FISHPLATE



37a-  
NUT

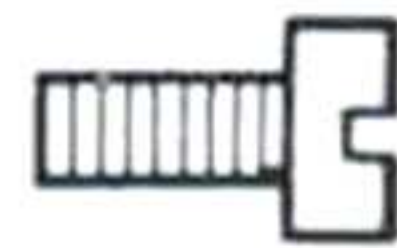

37 b+BOLT  
5 mm. (7/32")

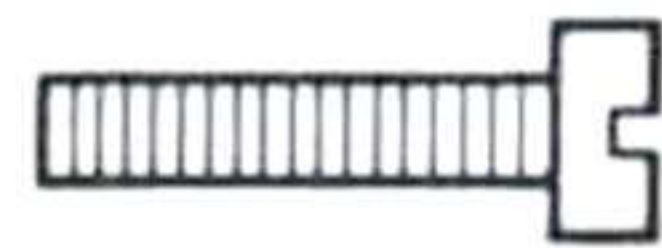

111a-BOLT  
12 mm. (½")

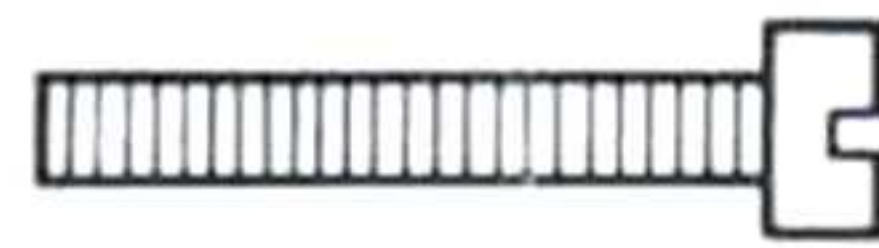

111-BOLT  
19 mm. (¾")



LENGTH OF  
CORD  
914 mm. (36")



235d-NARROW STRIP, 115 × 9 mm. (4½" × 11/32")





Pocket Meccano's the start of something big.

Now that you see what Meccano can do, try one of the basic Sets. There are ten of these Sets, and extra Conversion Sets enable you to progress easily from a basic Set to the next larger one. Also available are Motors as well as Gears, Mechanisms, Electrical and Electronic Sets for even more engineering fun.

Le jeu de Poche Meccano—une grande idée qui fera son chemin.

Maintenant que vous savez ce que peut faire Meccano, essayez l'un des jeux de base. Il y en a 10 avec jeux de conversion en supplément qui vous permettent de progresser facilement d'un jeu de construction de base à un autre plus complexe. Meccano met aussi à votre disposition des moteurs, engrenages, mécanismes, jeux électriques et électroniques pour un plaisir encore plus grand.

Taschen-Meccano ist der Beginn von etwas Grossem.

Da Sie jetzt sehen können, wozu Meccano fähig ist, probieren Sie einen der Grundkästen aus. Es gibt zehn dieser Anlagen. Extra Ergänzungskästen ermöglichen Ihnen einen leichten Übergang von einem Grundkasten zu dem nächst größeren. Außerdem gibt es Motoren sowie Getriebe, Apparaturen, elektrische und elektronische Anlagen für noch größeren technischen Spaß.

Pocket Meccano is het begin van iets groots.

Nu je gezien hebt wat je met Meccano kunt doen, kun je één van de grotere sets proberen. Er zijn 10 basis constructiesets, en met de extra uitbreidingssets is het mogelijk nog grotere Meccano-modellen te bouwen. Ook zijn elektromotors verkrijgbaar, evenals tandwielen, drijfwerk-uitrustingen, elektrische-en elektronische sets.

Il Meccano tascabile segna l'inizio di grandi lavori futuri.

Ora che avete constatato la versatilità del Meccano, provate con una scatola base. Le scatole basi sono dieci oltre alle scatole di conversione che servono a trasformare una scatola base in quella successiva di misura più grande. Sono anche reperibili motori, scatole ingranaggi, scatole meccanismi, scatole elettriche ed elettroniche per costruzioni più avanzate.

Lomme-Meccano er begynnelsen til noe stort.

Nå når du har oppdaget hvor morsomt Meccano kan være bør du forsøke et av grunnsettene. Det finnes ti slike sett, og ekstra omdannelsesett gjør at du kan gå skrittvis frem fra ett grunnsett til det neste og større. Du kan også skaffe deg gir og mekanismer, og elektriske og elektroniske sett slik at det blir enda morsommere.



## 2 Basic Constructions

BC1 is a method of joining two strips together so that they move in relation to each other ('lock-nutting').

Tighten two Nuts together on the Bolt.

**The Nuts must not grip the Strips tightly.**

BC2 is another method of 'lock-nutting'.

Two Nuts, one above and one below Strip 'a' are tightened against the Strip by turning them as indicated.

## 2 Constructions de base

BC1 est une méthode d'assemblage de deux bandes de manière à ce qu'elles bougent l'une par rapport à l'autre (principe "écrous indesserrables").

Serrez ensemble les deux écrous sur le boulon. **Les écrous ne doivent pas trop serrer les bandes.**

BC2 est une autre méthode d'assemblage par "écrous indesserrables." Deux écrous, l'un au-dessus et l'autre au-dessous de la bande "a" sont serrés contre la bande en les tournant comme indiqué.

## 2 Grundkonstruktionen

BC1 ist eine Methode, wobei zwei Bänder zusammengefügt werden, sodaß sie sich im Verhältnis zueinander bewegen ('Gegenmutter').

Schrauben Sie zwei Muttern zusammen am Bolzen fest. **Die Muttern dürfen die Bänder nicht festklemmen.**

BC2 ist eine andere 'Gegenmutter' Methode. Zwei Muttern, eine über und eine unter Band 'a', werden gegen die Band festgeschraubt, indem sie wie abgebildet gedreht werden.

## 2 basic bouwmethoden

BC1 is een methode waarbij twee stroken zodanig aan elkaar worden vastgezet dat ze ten opzichte van elkaar kunnen draaien (met borgmoeren).

Draai twee moeren op een bout. **De moeren mogen de stroken niet stevig vasthouden.**

BC2 is een andere methode om stroken draaibaar vast te zetten. Twee moeren, nl. één boven en één onder strook 'a' worden tegen de strook vastgezet door

ze te draaien zoals in de afbeelding is aangegeven.

## 2 sistemi fondamentali di costruzione

BC1 è il metodo per unire due strisce in modo che questi possano muovere l'uno rispetto l'altro (**bloccaggio con controdado**).

Fissare i due dadi reciprocamente sulla vite. I dadi devono esercitare soltanto un leggero bloccaggio sulla striscia.

BC2 un secondo metodo di "bloccaggio con controdado." I due dadi, uno al disopra e l'altro al disotto della striscia 'a', vengono fissati contro la striscia girandoli nel senso indicato,

## 2 grunnkonstruksjoner

BC1 er en måte å sette to deler sammen på slik at de kan bevege seg i forhold til hverandre ("låsemoerter"). Trekk til to muttere på boltene. **Mutterne må ikke slutte stramt til delen.**

BC2 er en annen måte å utføre dette på. To muttere, en over og en under delen "a," trekkes til ved å dreie dem som angitt på illustrasjonen.

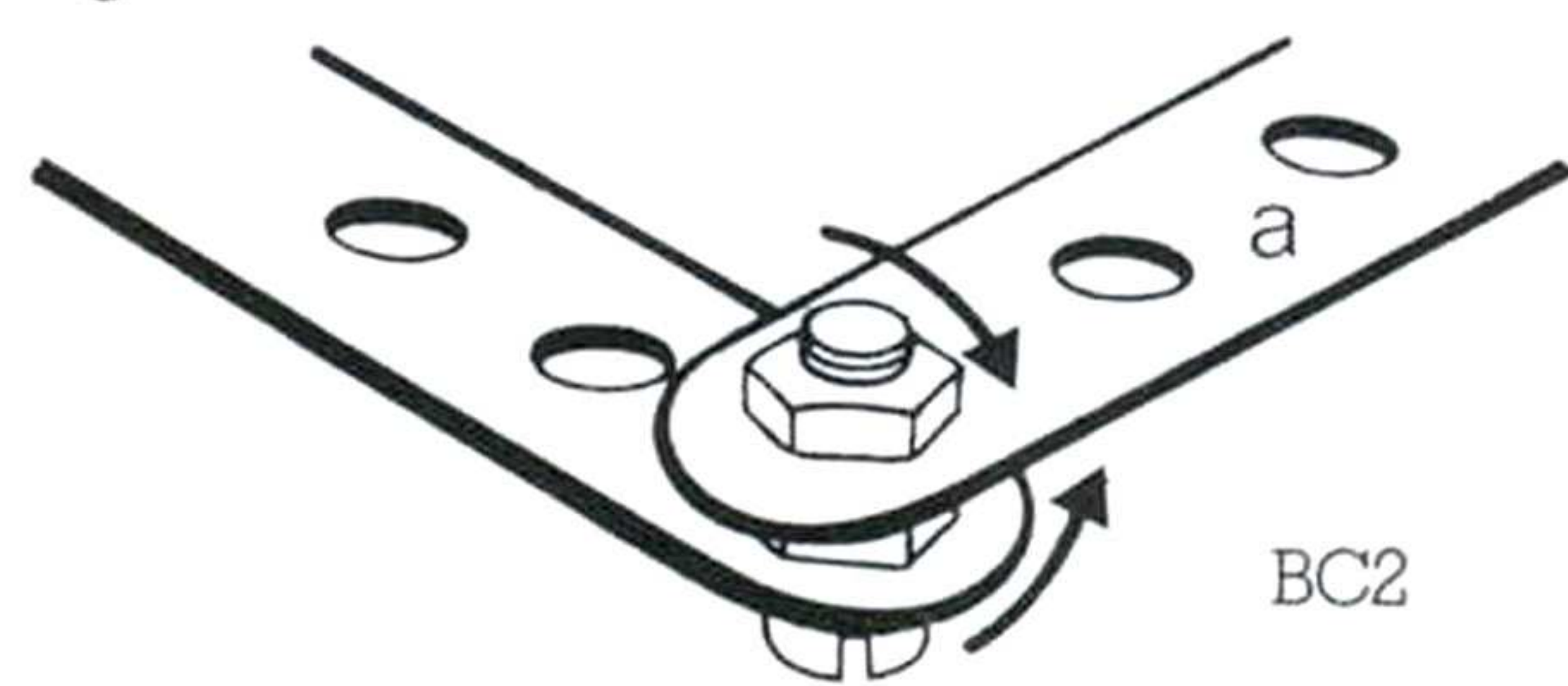
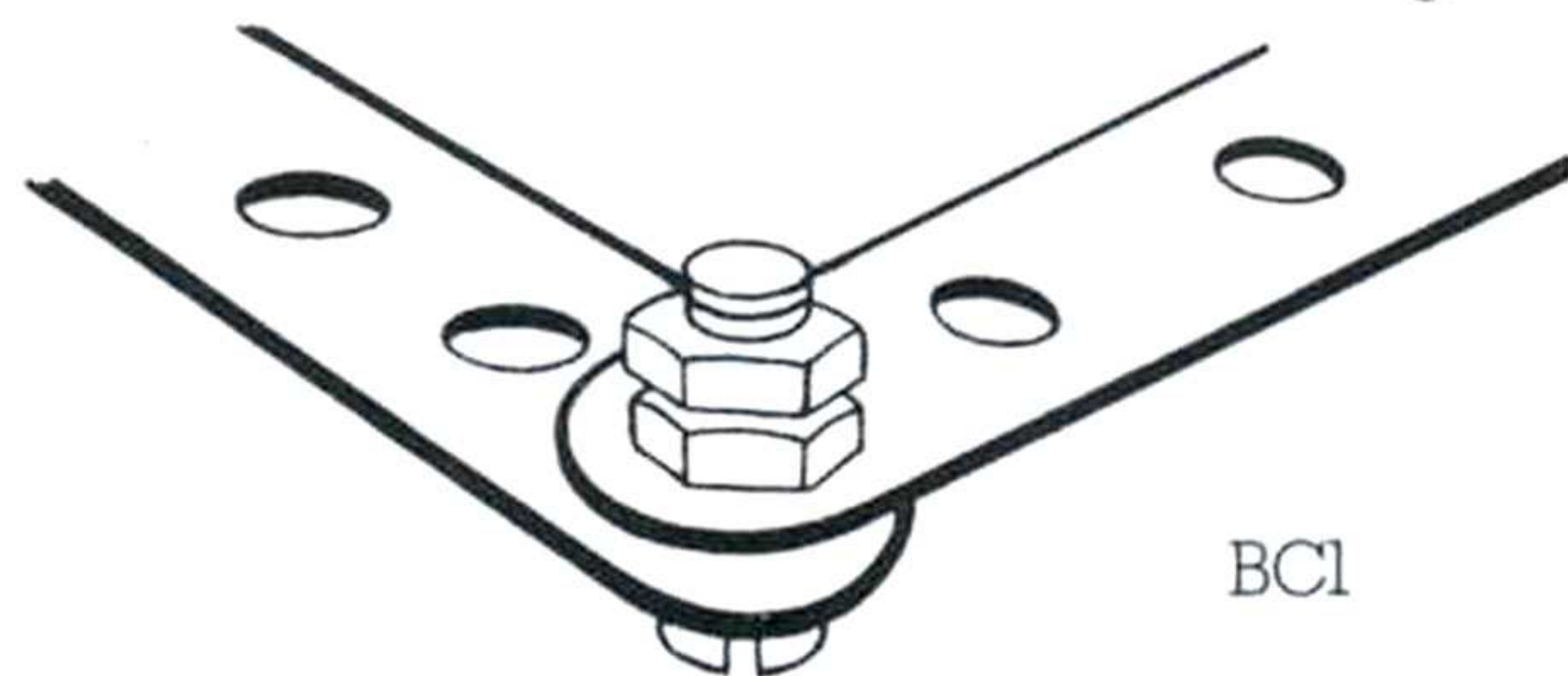



You can design more yourself!  
Vous pouvez en créer d'autres vous-mêmes!  
Sie können selbst noch mehr entwerfen!  
Je kunt zelf nog meer ontwerpen maken!  
Progettare altri modelli voi stessi!  
Du kan finne på flere selv!

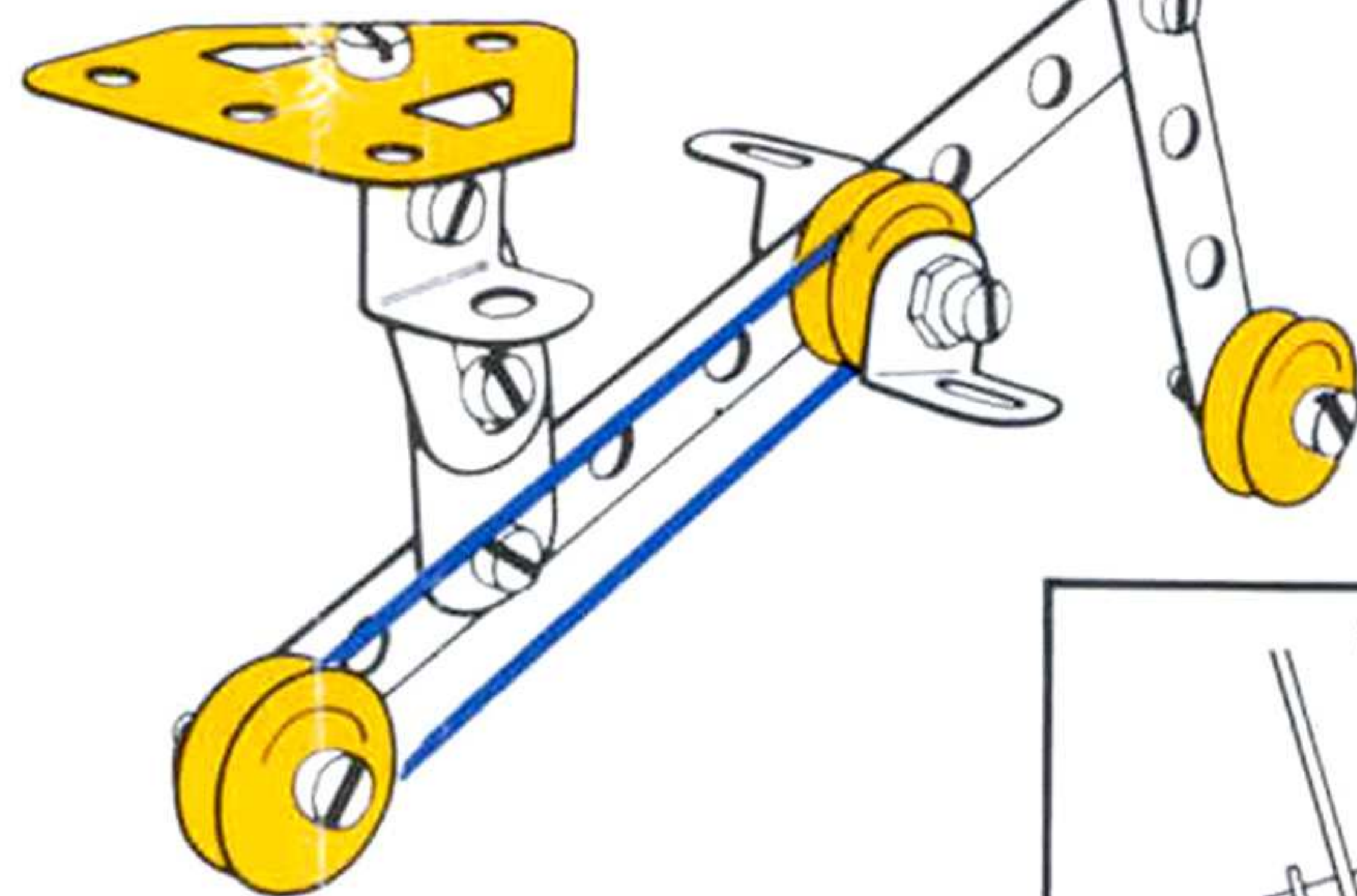
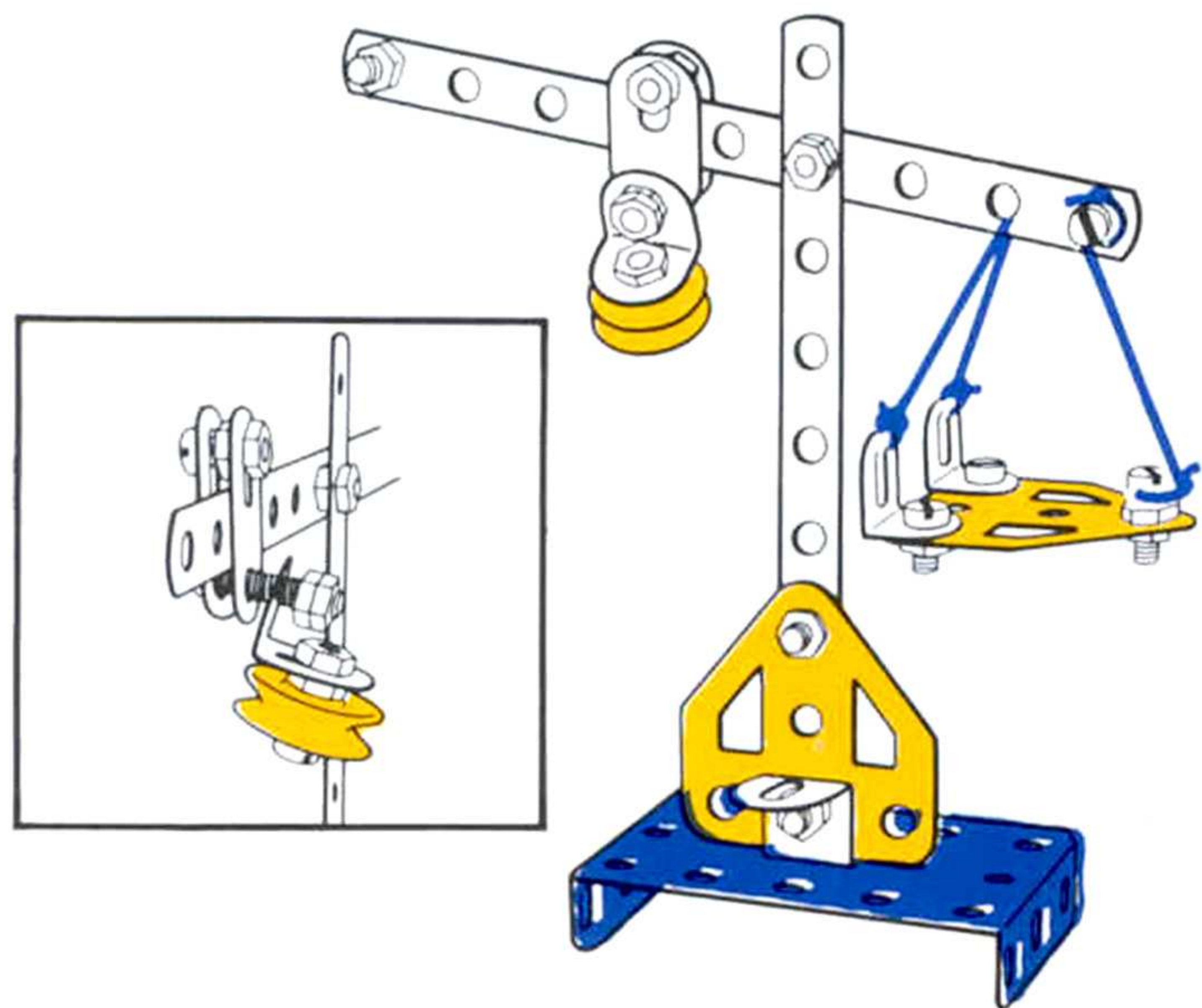

BICYCLE

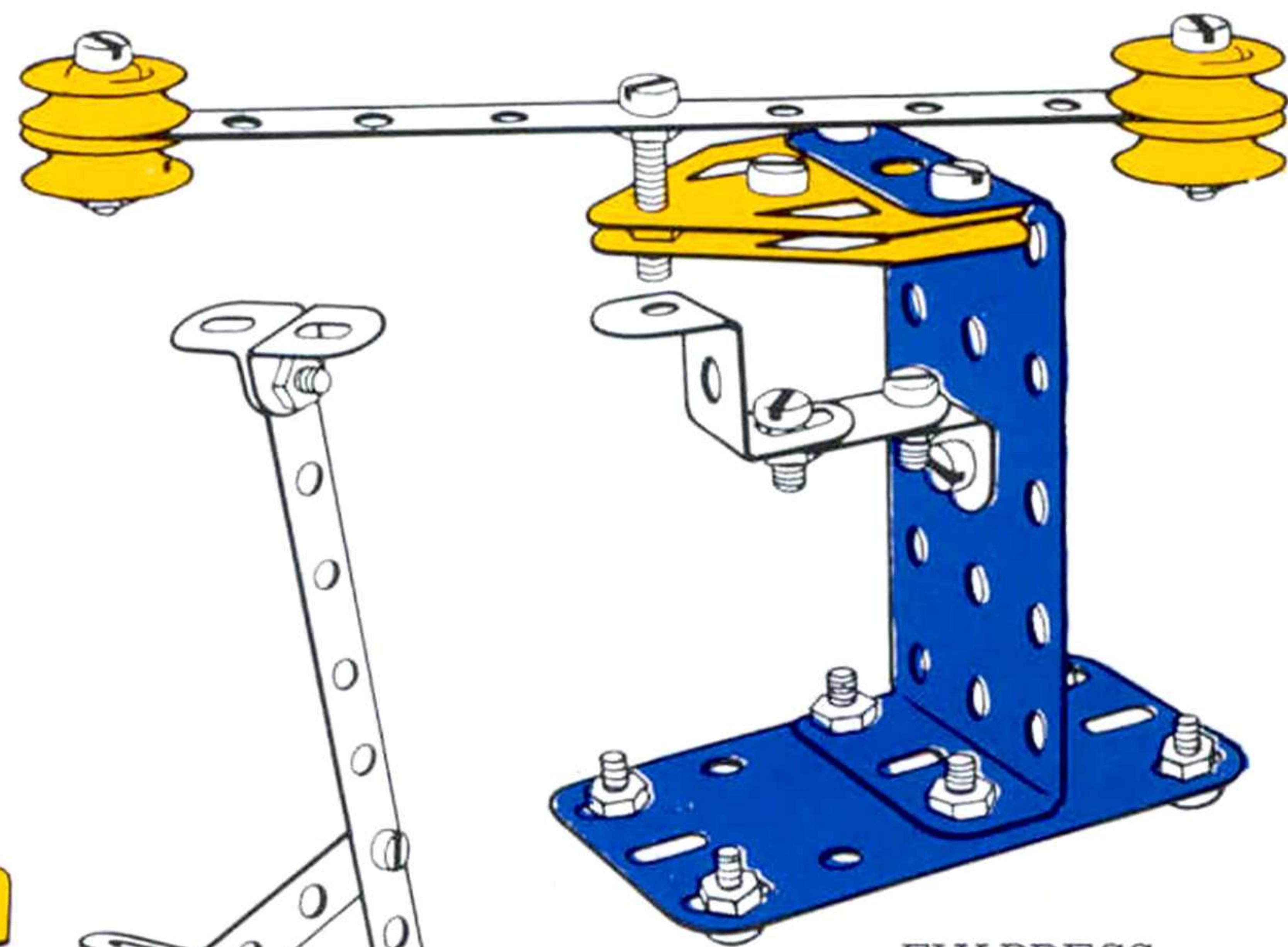

FLY PRESS

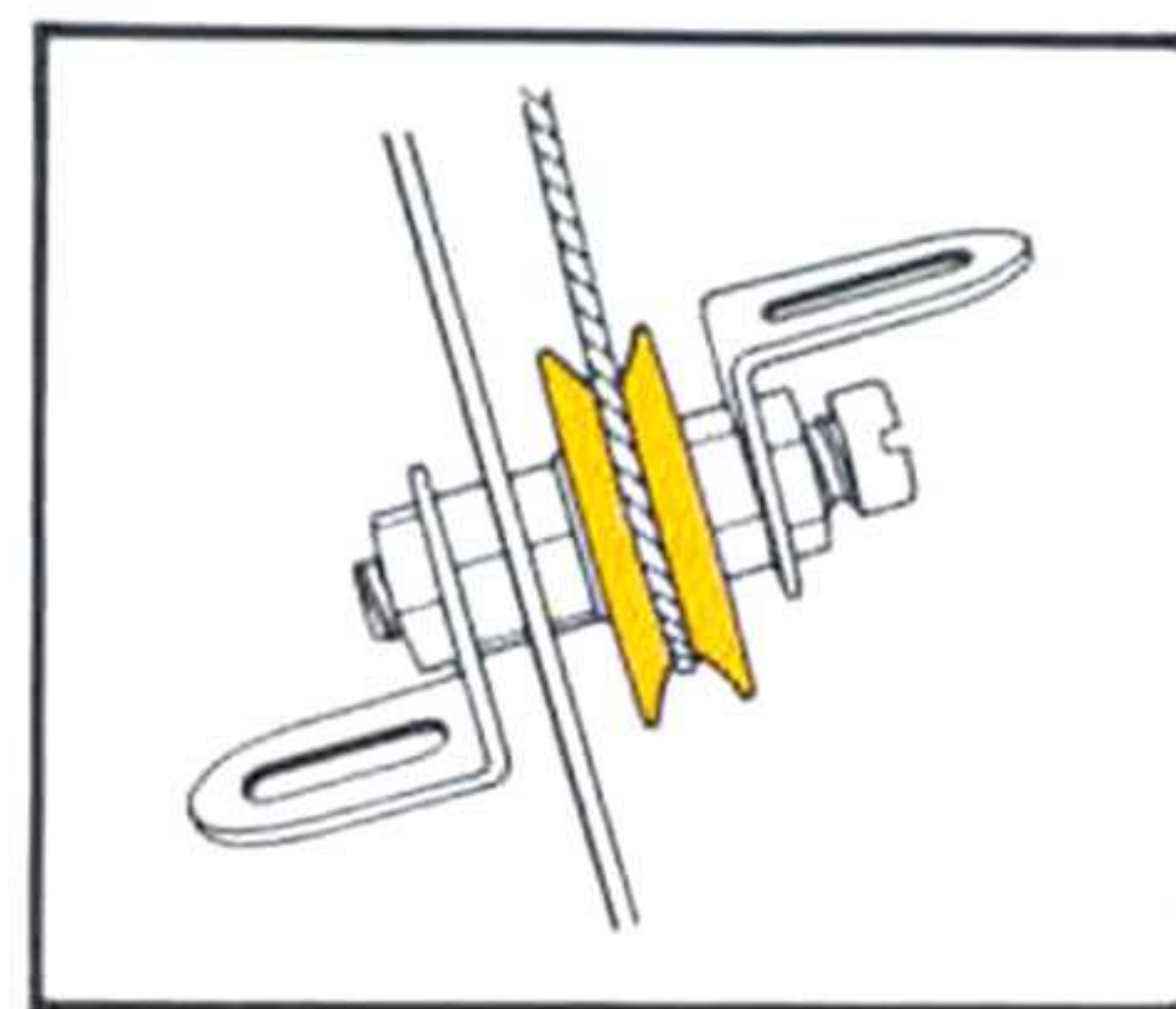



Here are the first 25 fun-packed models!  
Voici les 25 premières constructions à faire!

MONOPLANE

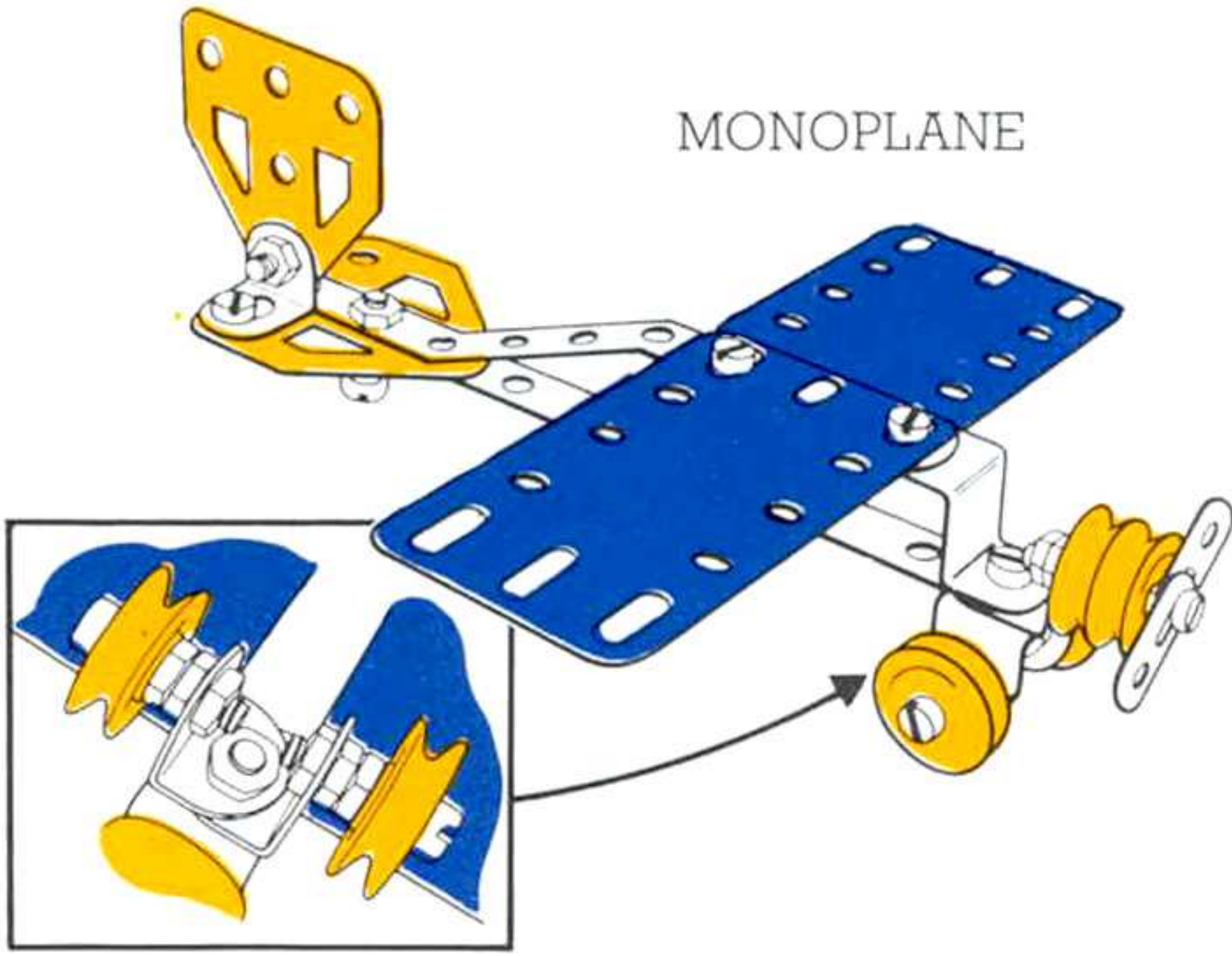

ROTARY MOWER

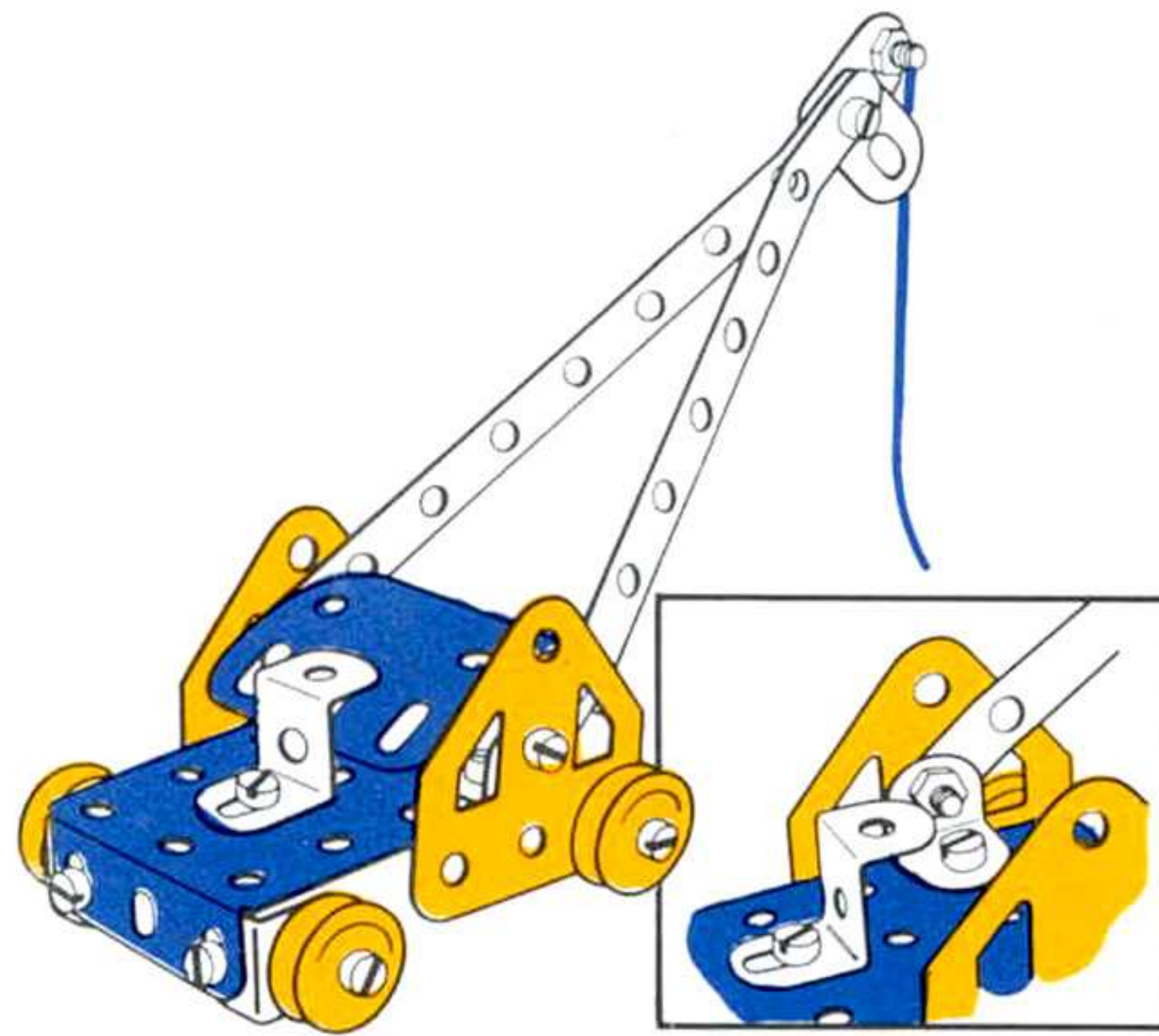

MOTOR SCOOTER

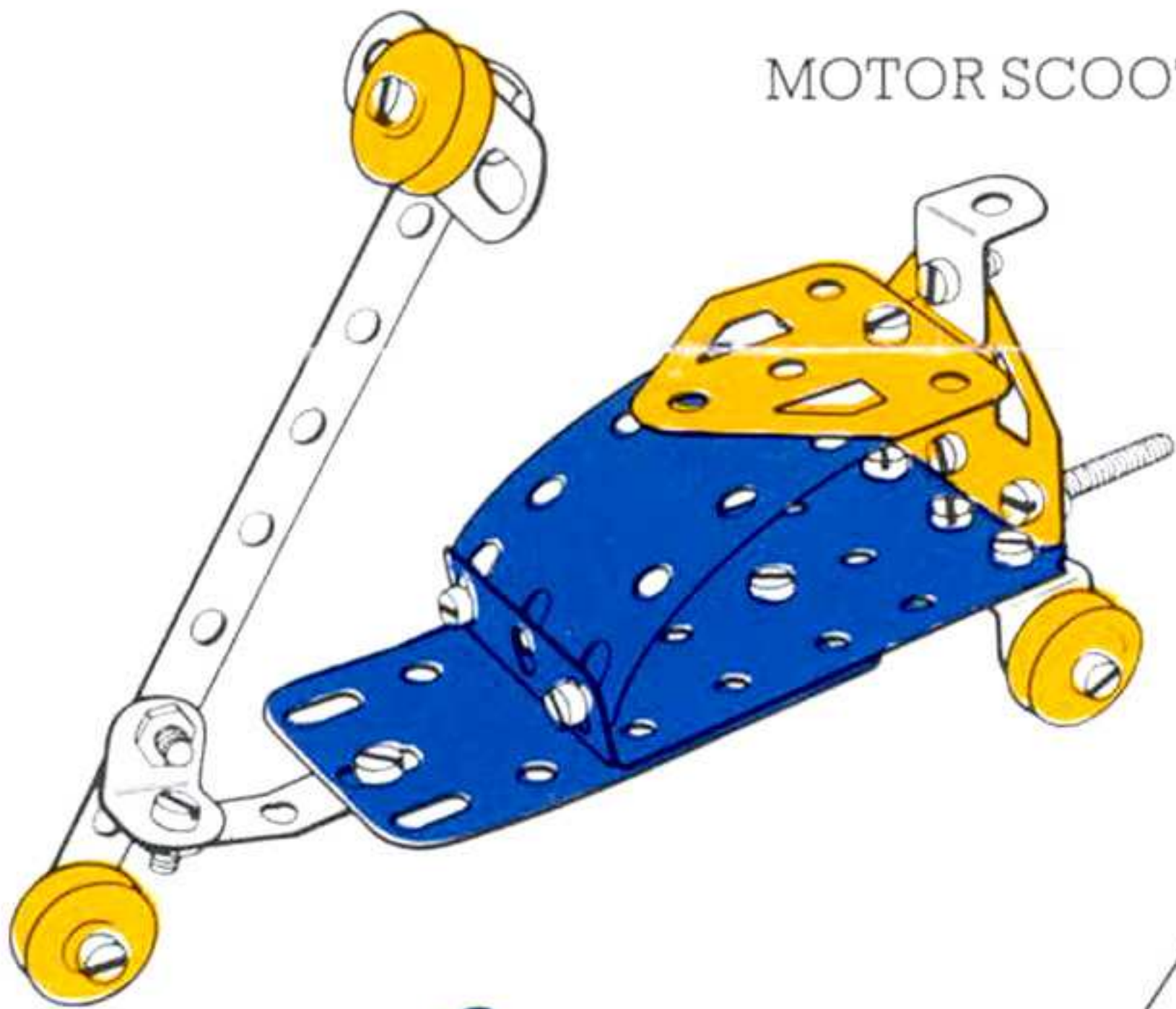

VETERAN CAR

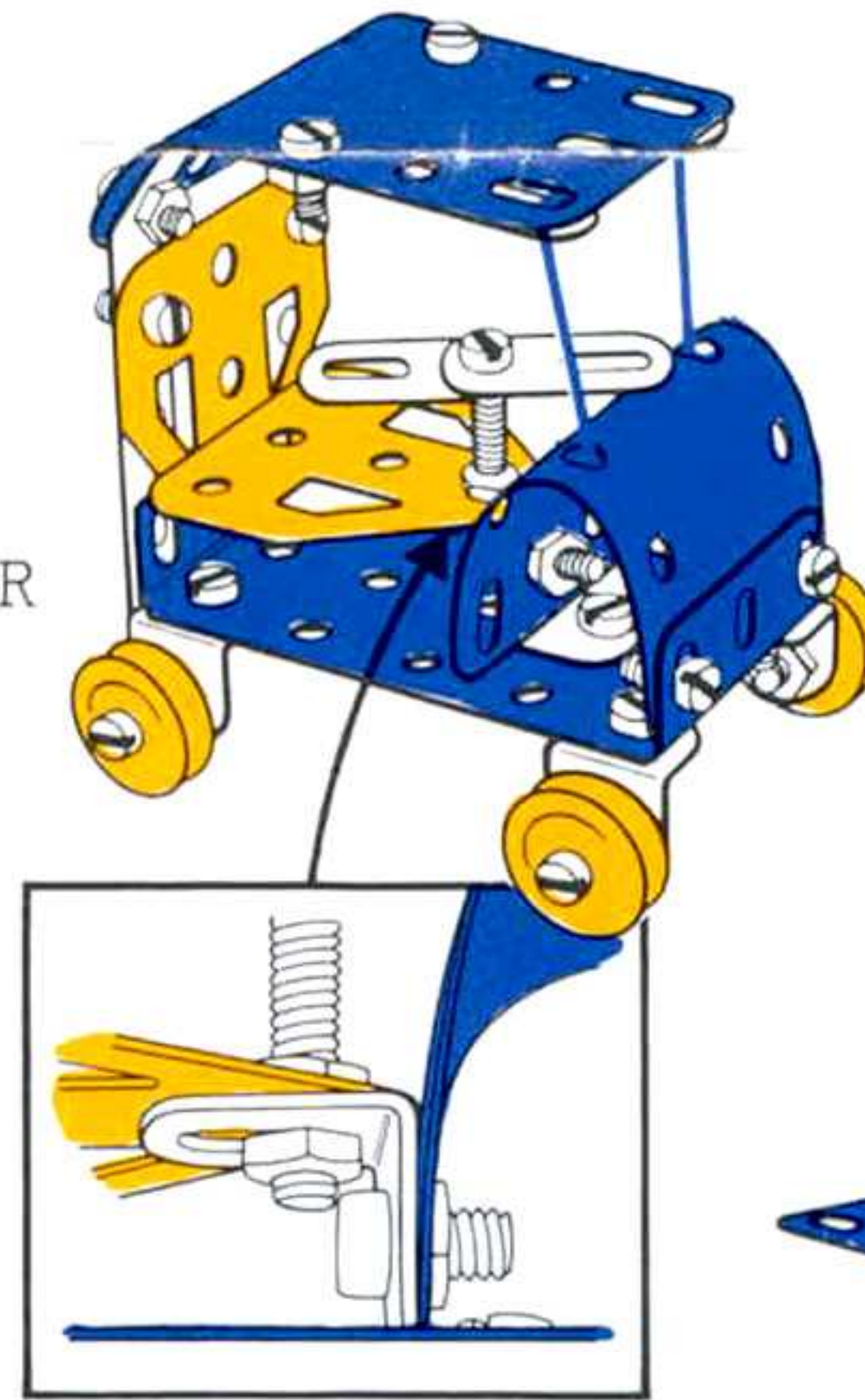

LAWN MOW



BIRD WITH WORM

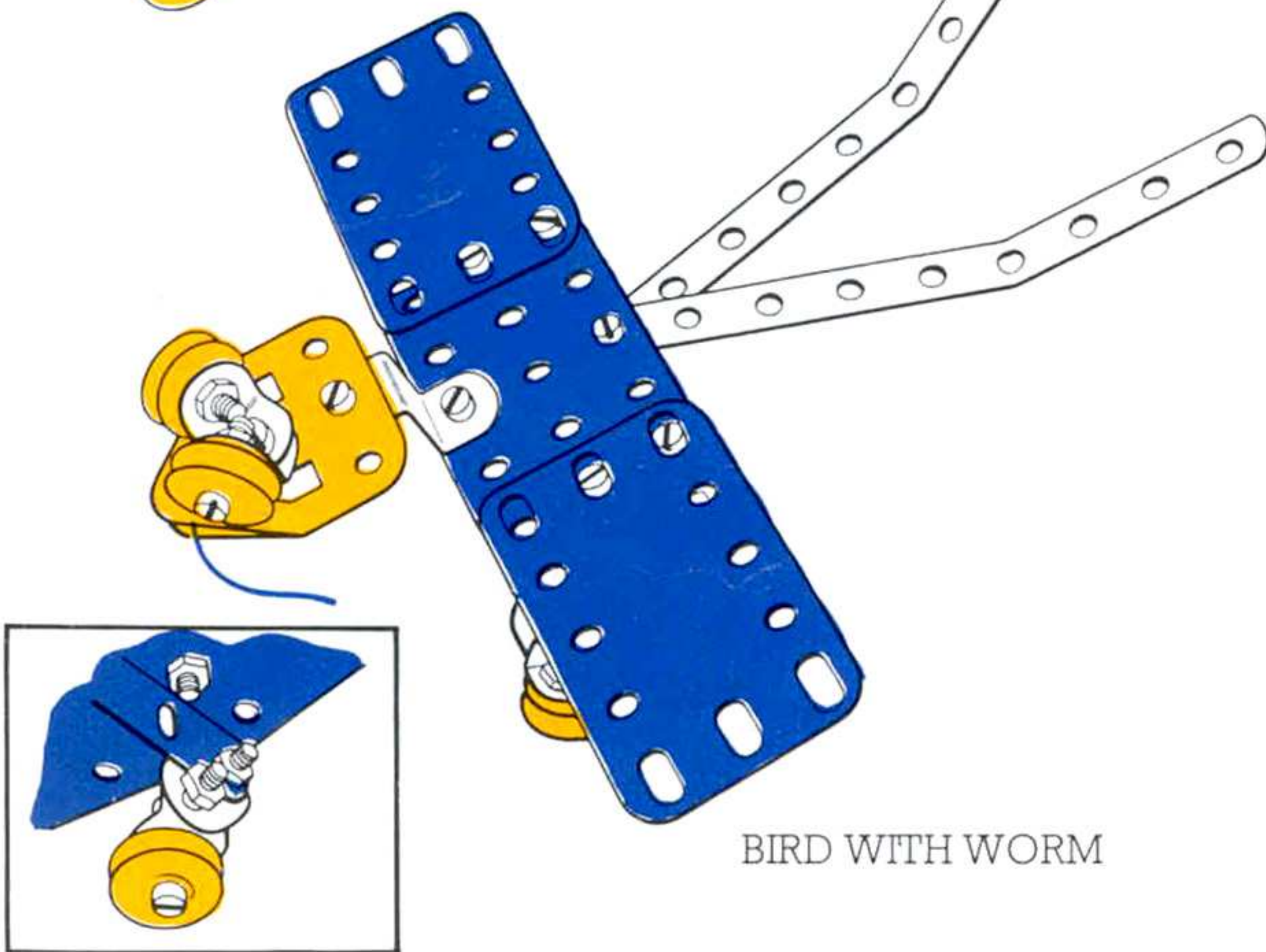

LETTER BALANCE

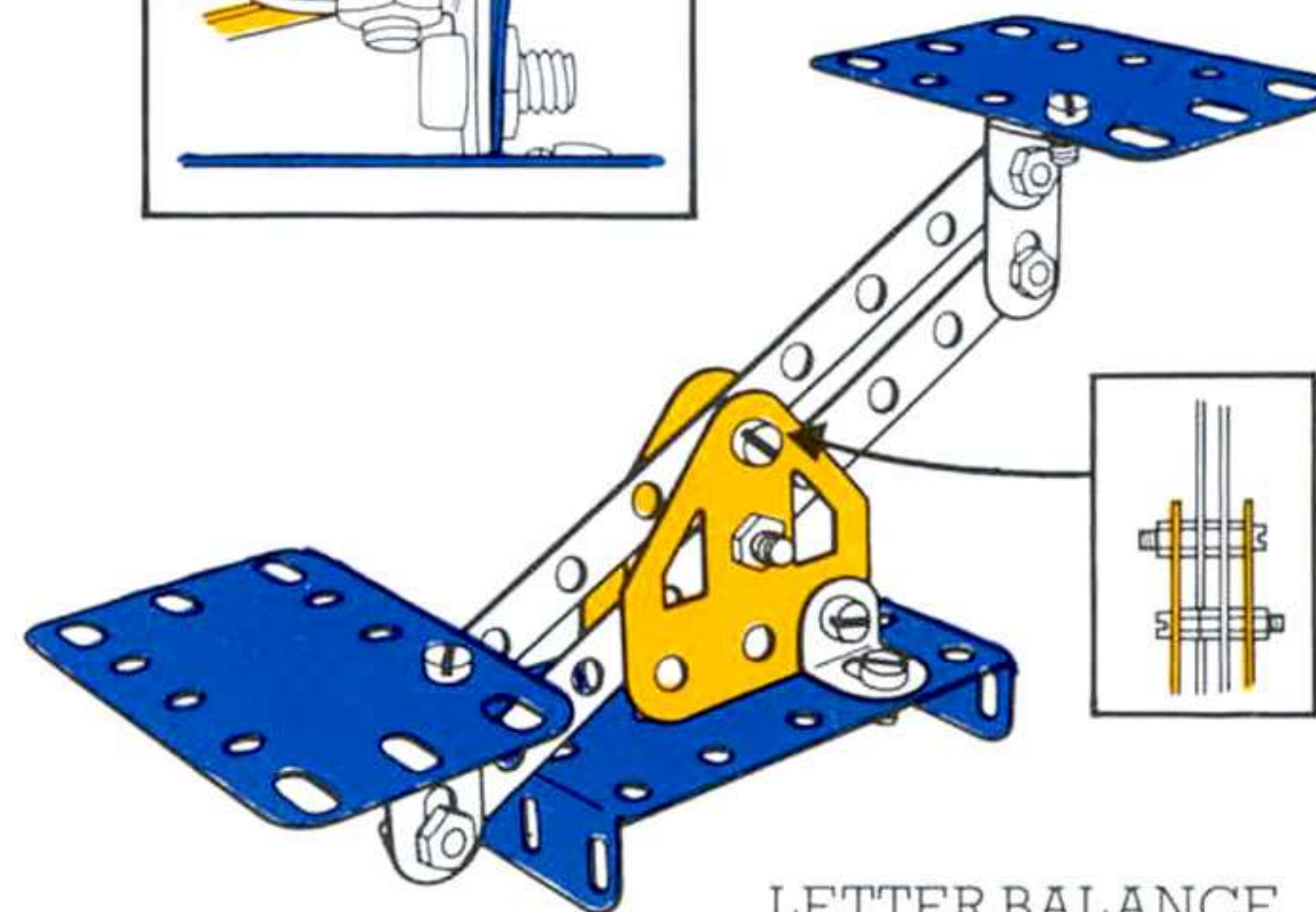



Hier sind die ersten 25 spass-verpackten modelle!  
Hier zijn de eerste 25 modellen waaraan je veel  
genoegen zult beleven!

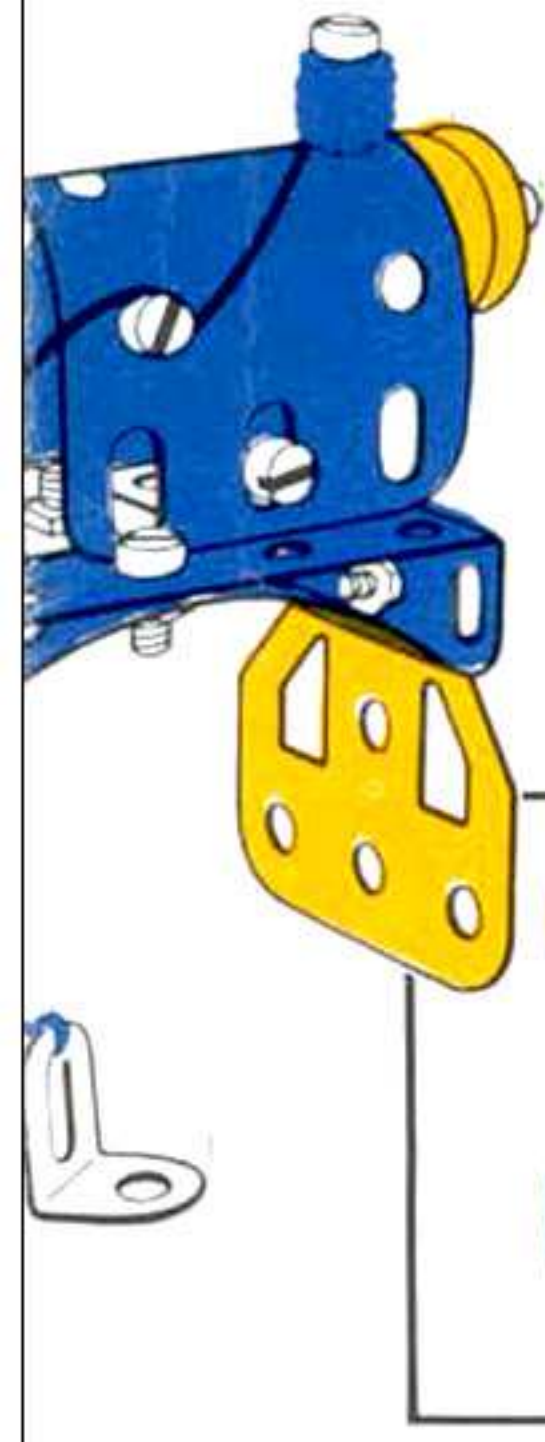

SEWING MACHINE

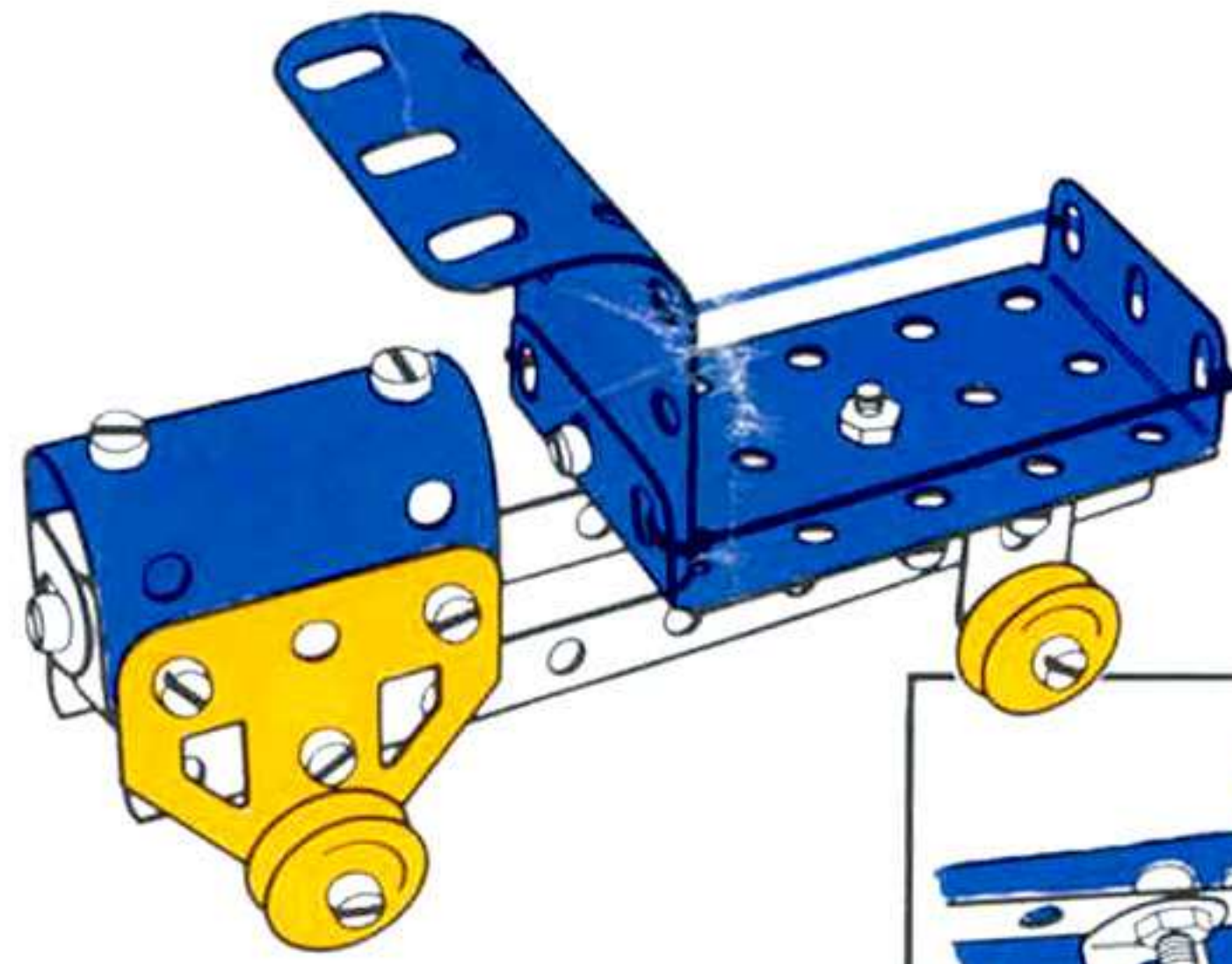
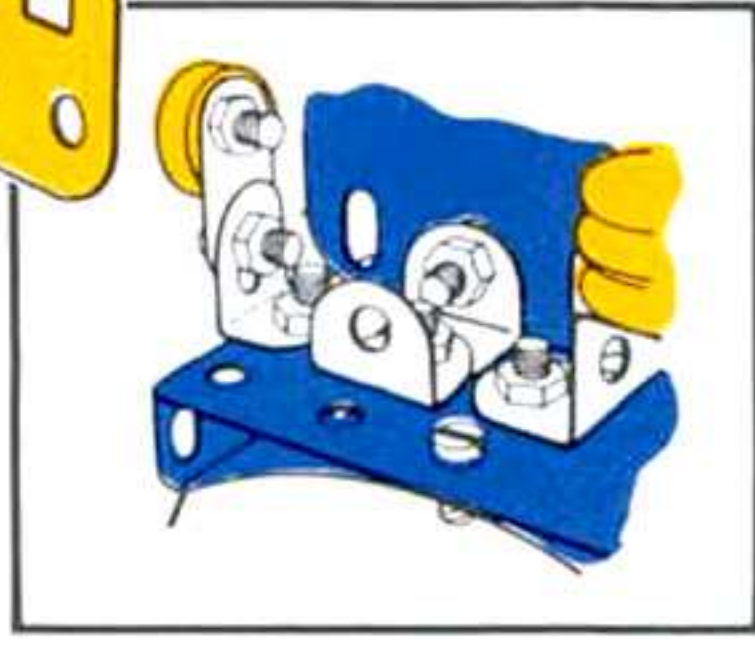

VINTAGE TRUCK

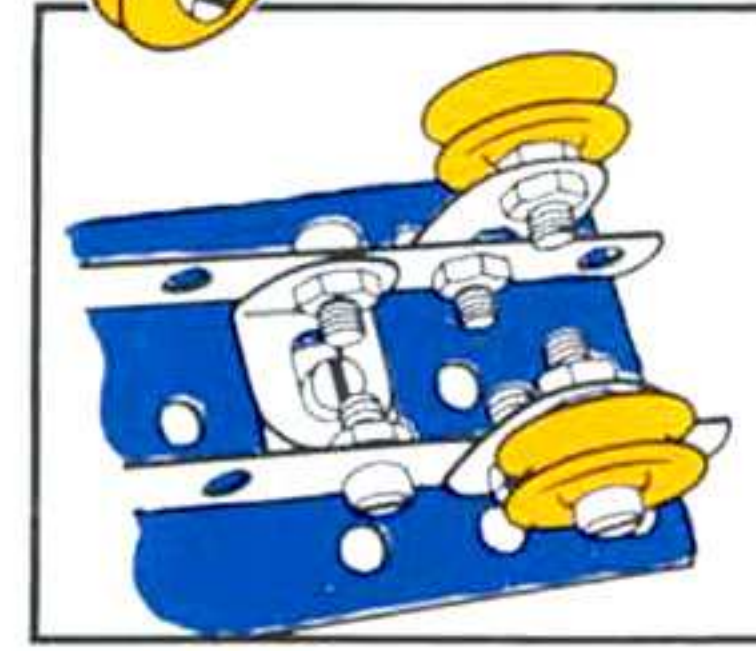

GARDEN SWING

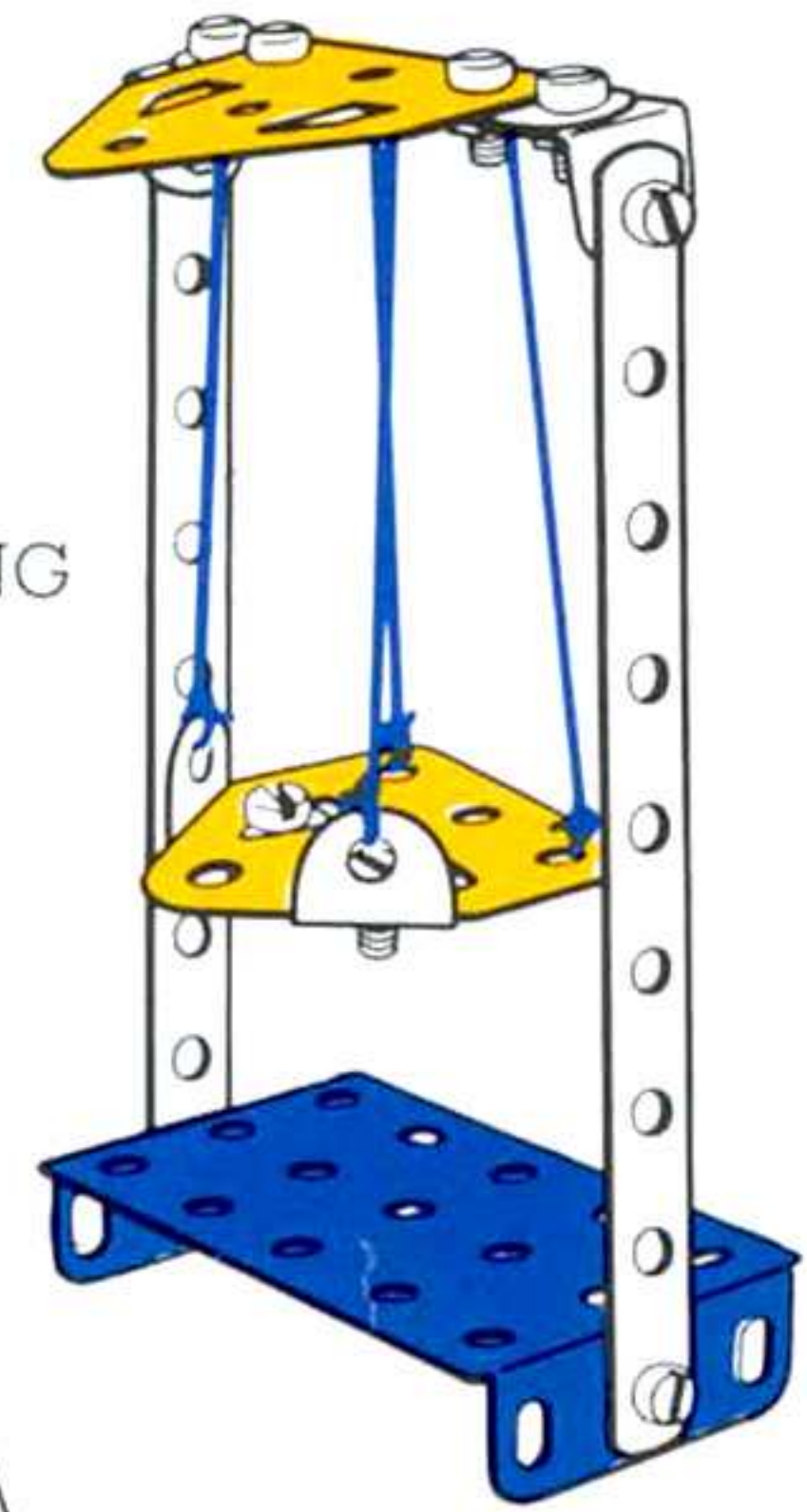

TV. CAM

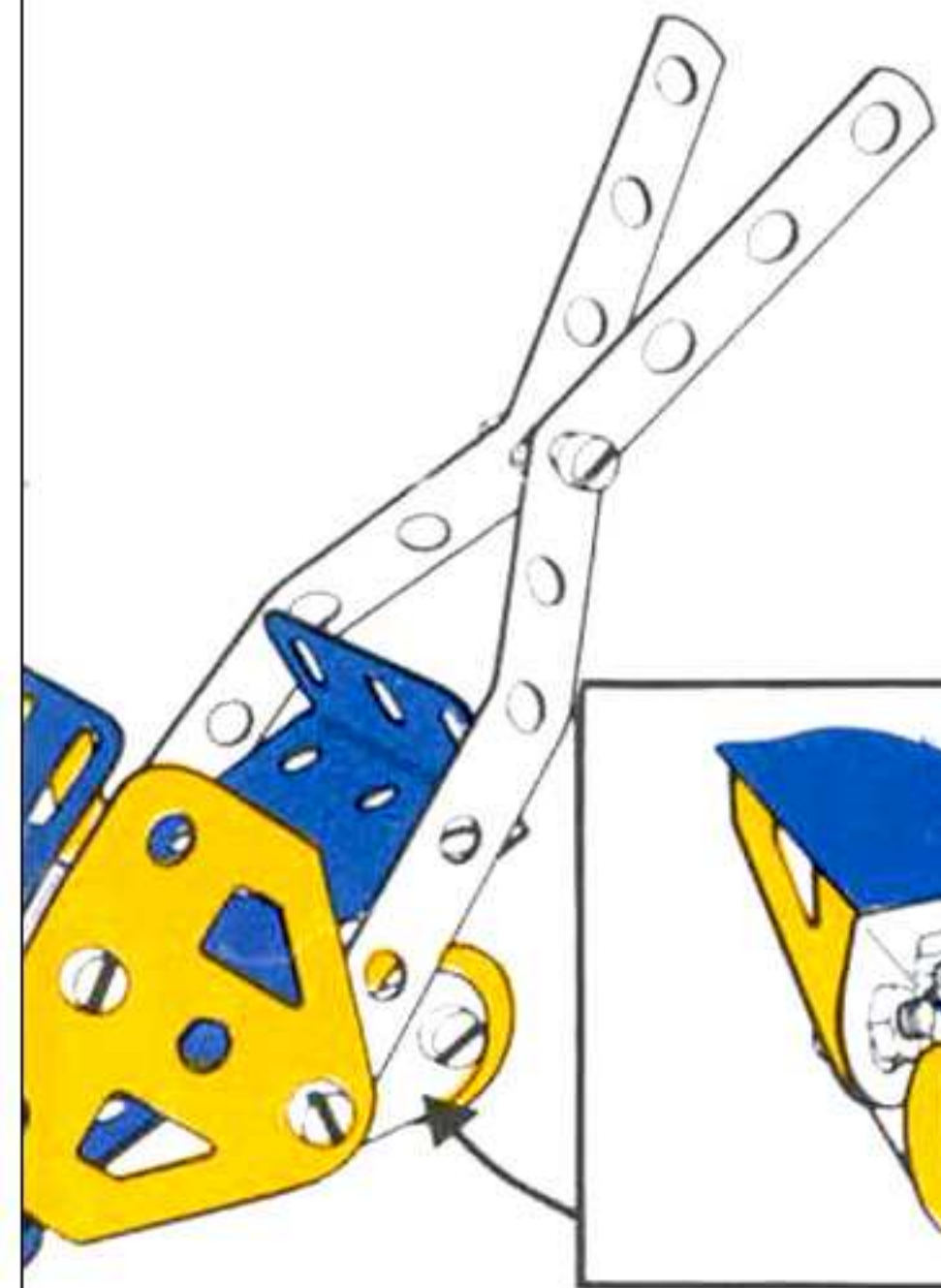

LAWN MOWER

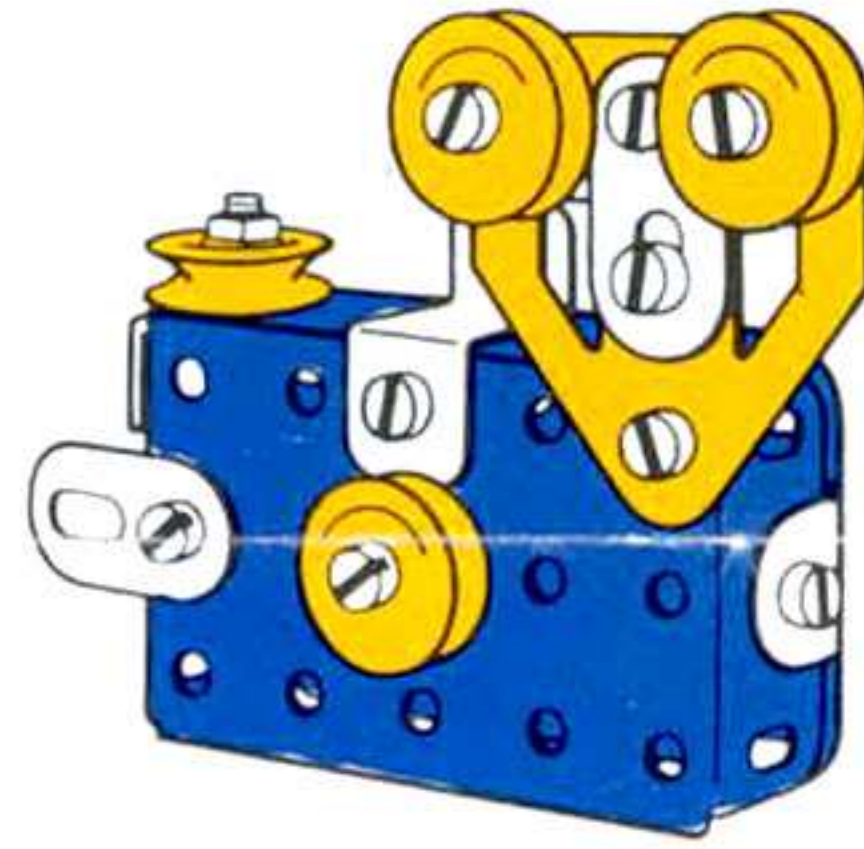
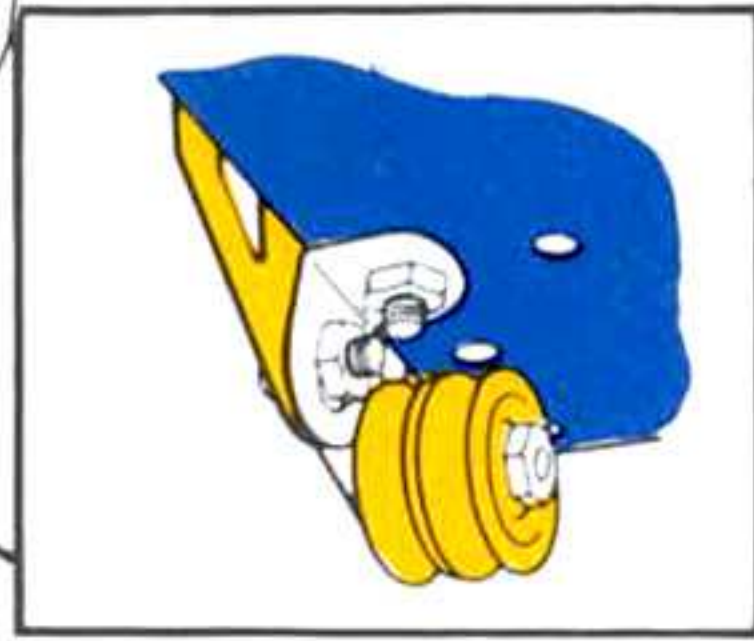

FLASH CAMERA

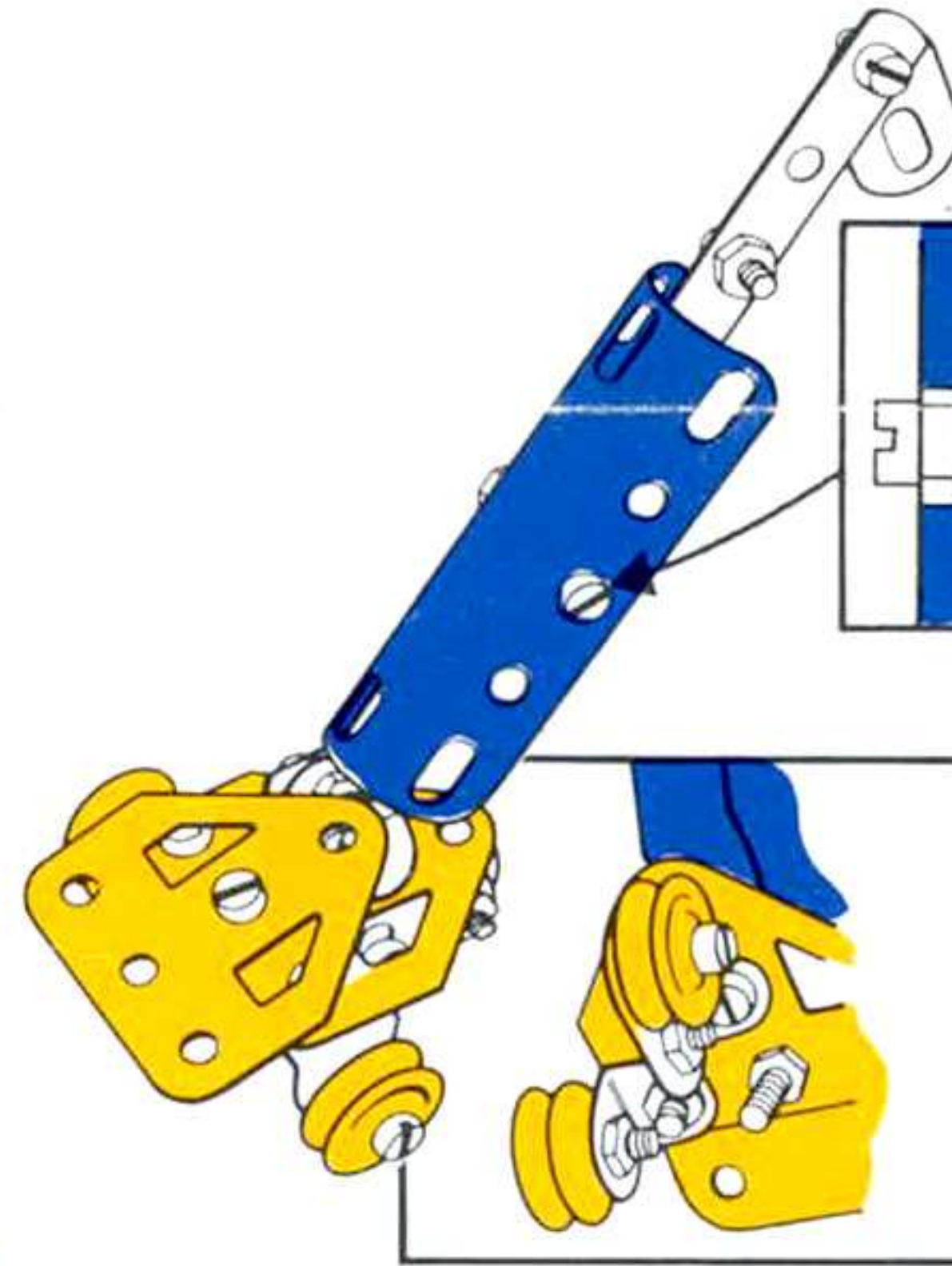

VACUUM CLEANER

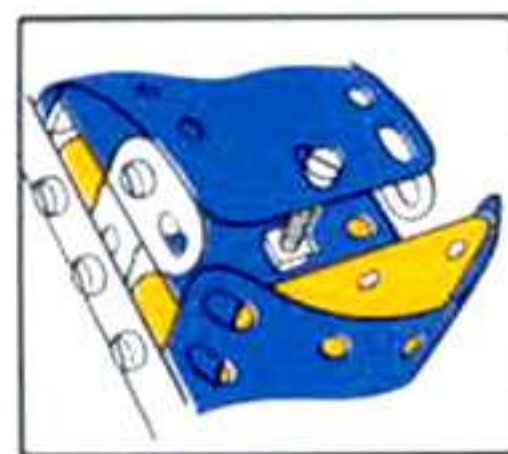
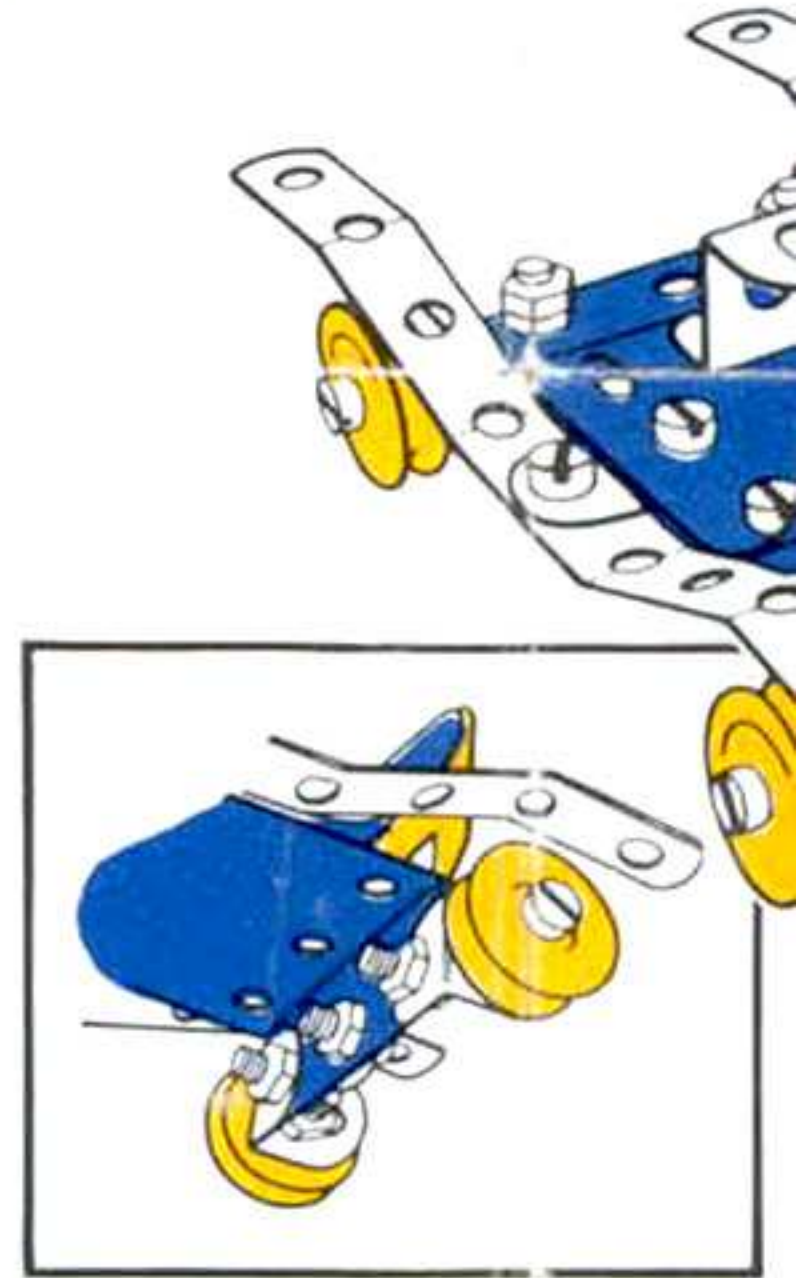
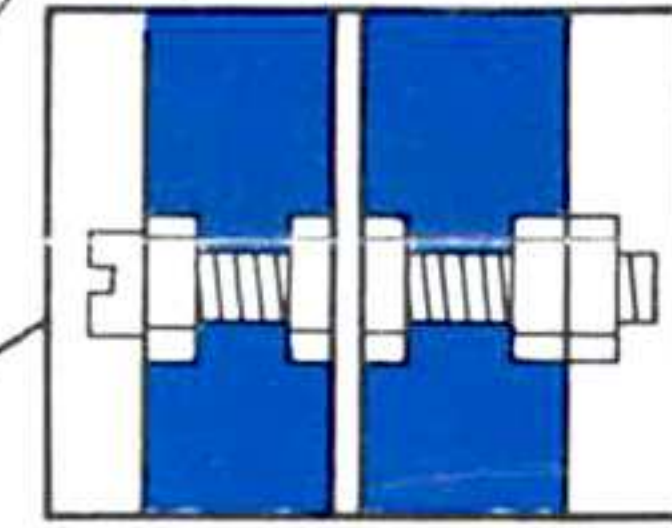

BOBSLEIGH

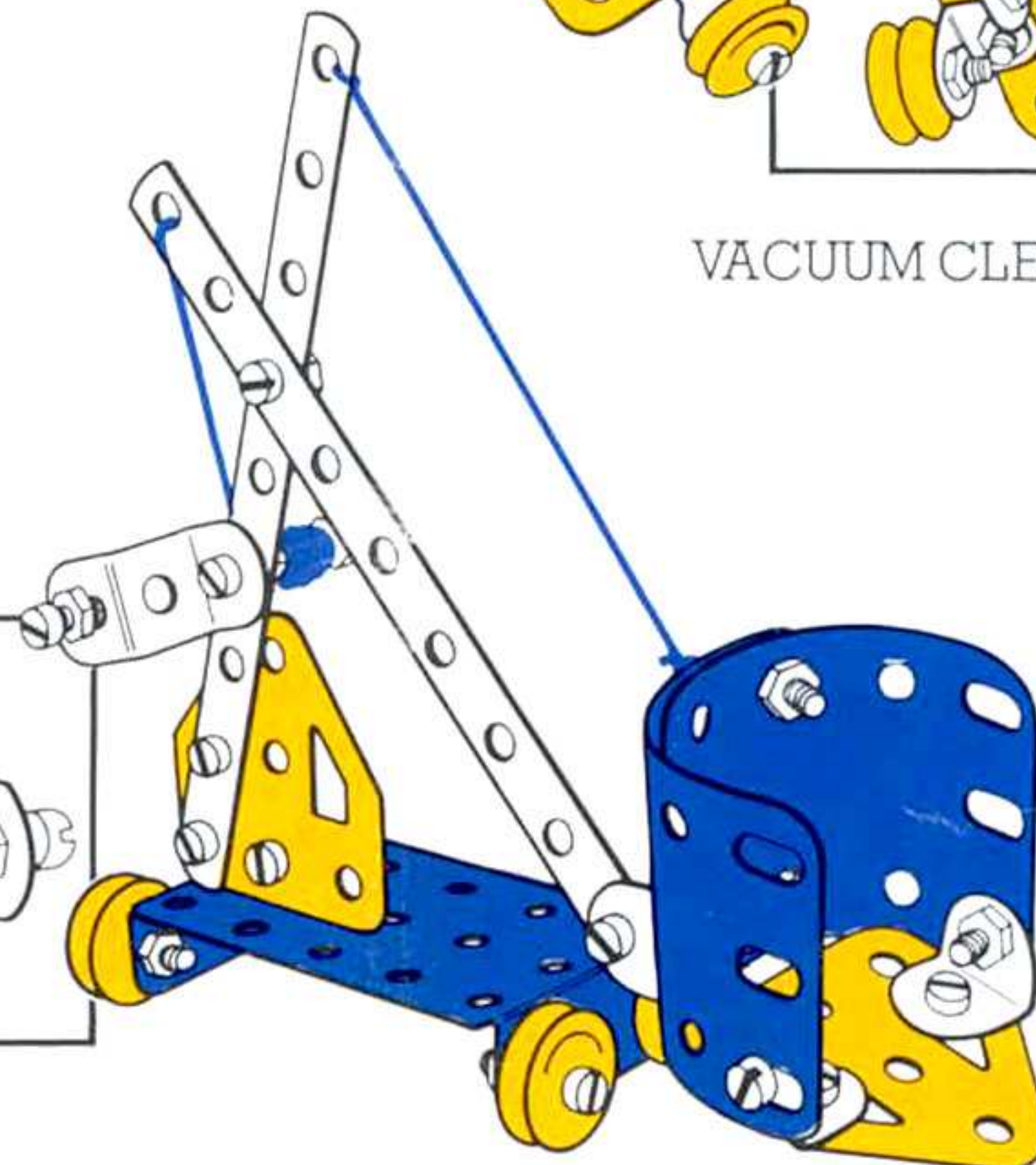
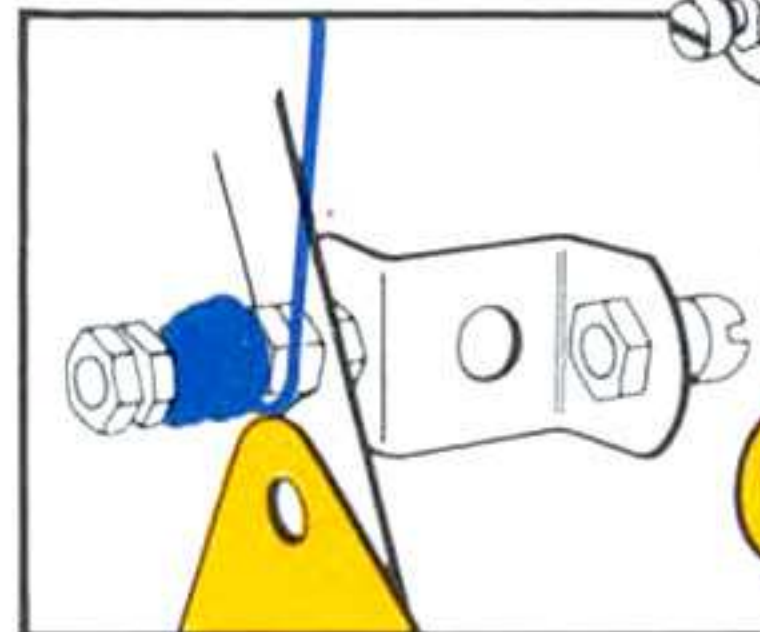
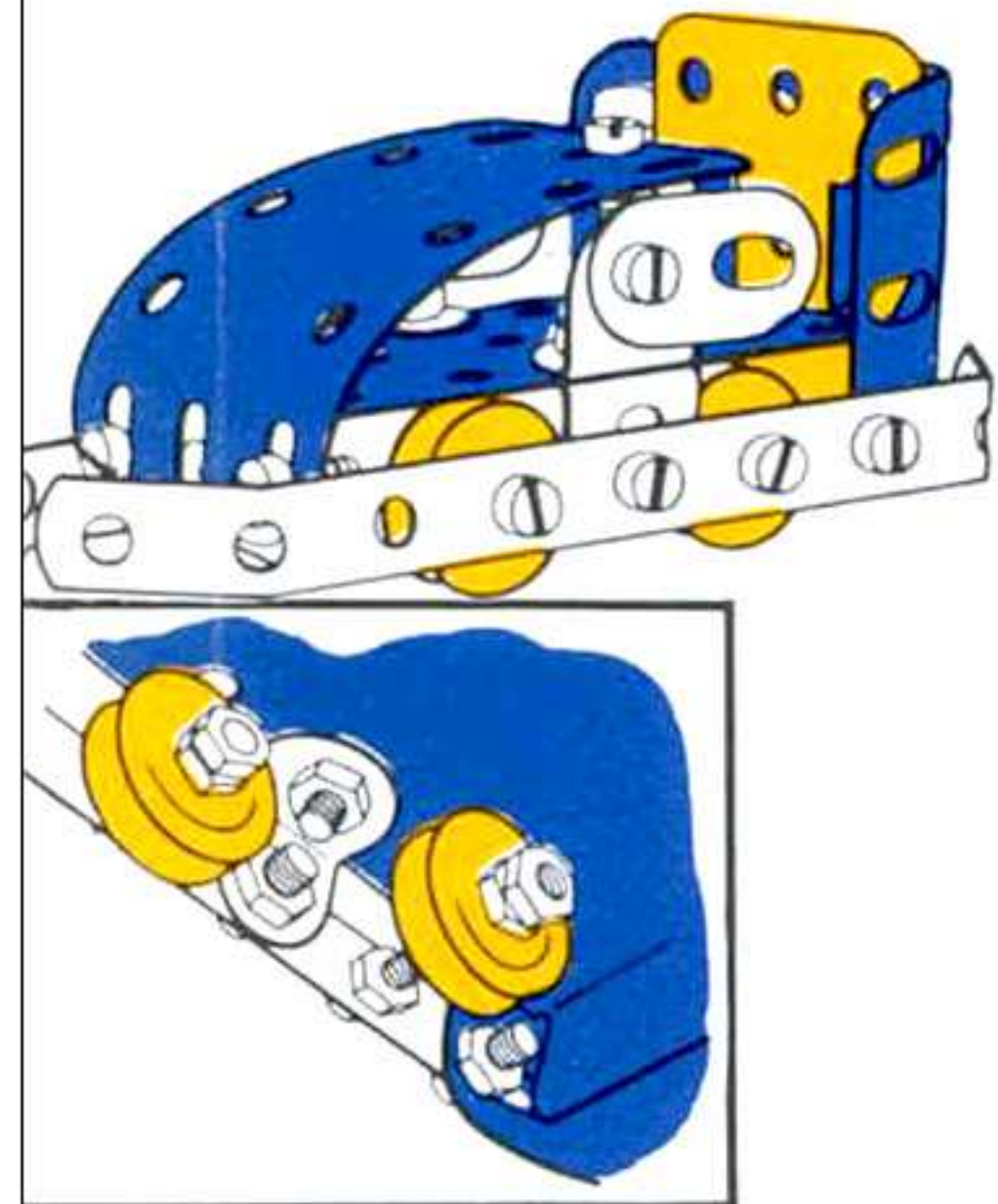

ELEVATING PLATFORM TROLLEY

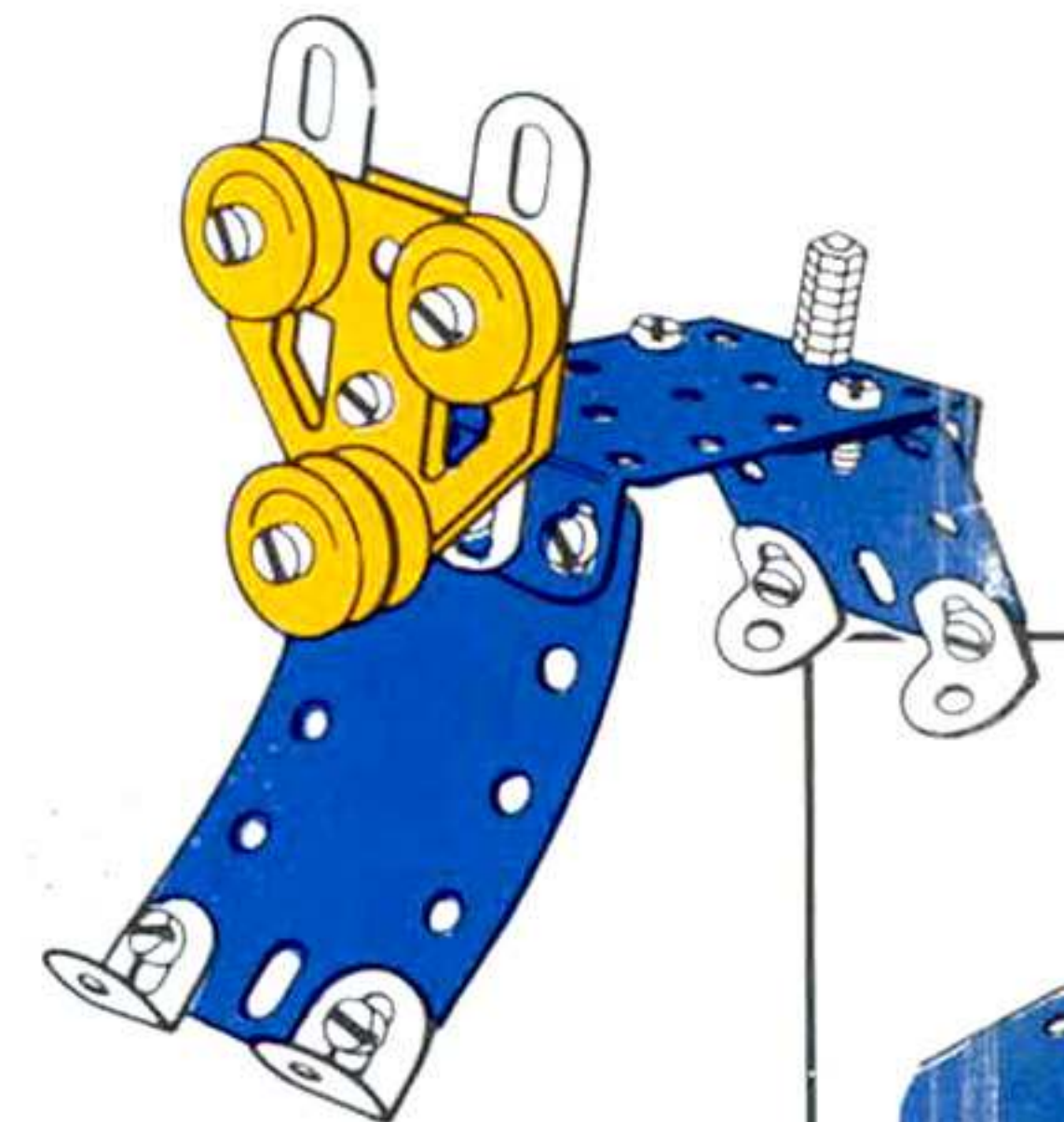

JUMPING DOG





Ecco i primi 25 eccitanti modelli!

Her er de første 25 modellene fulle av moro!

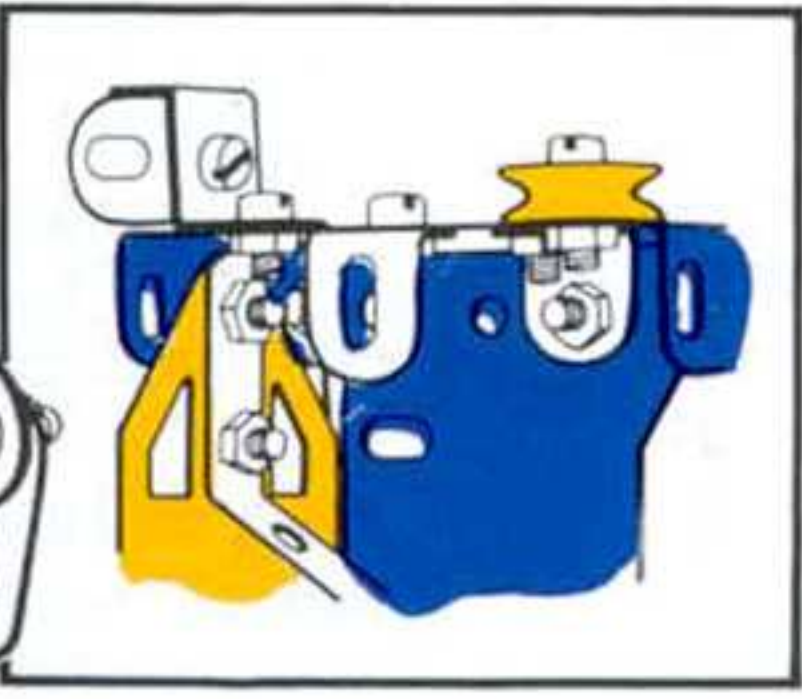
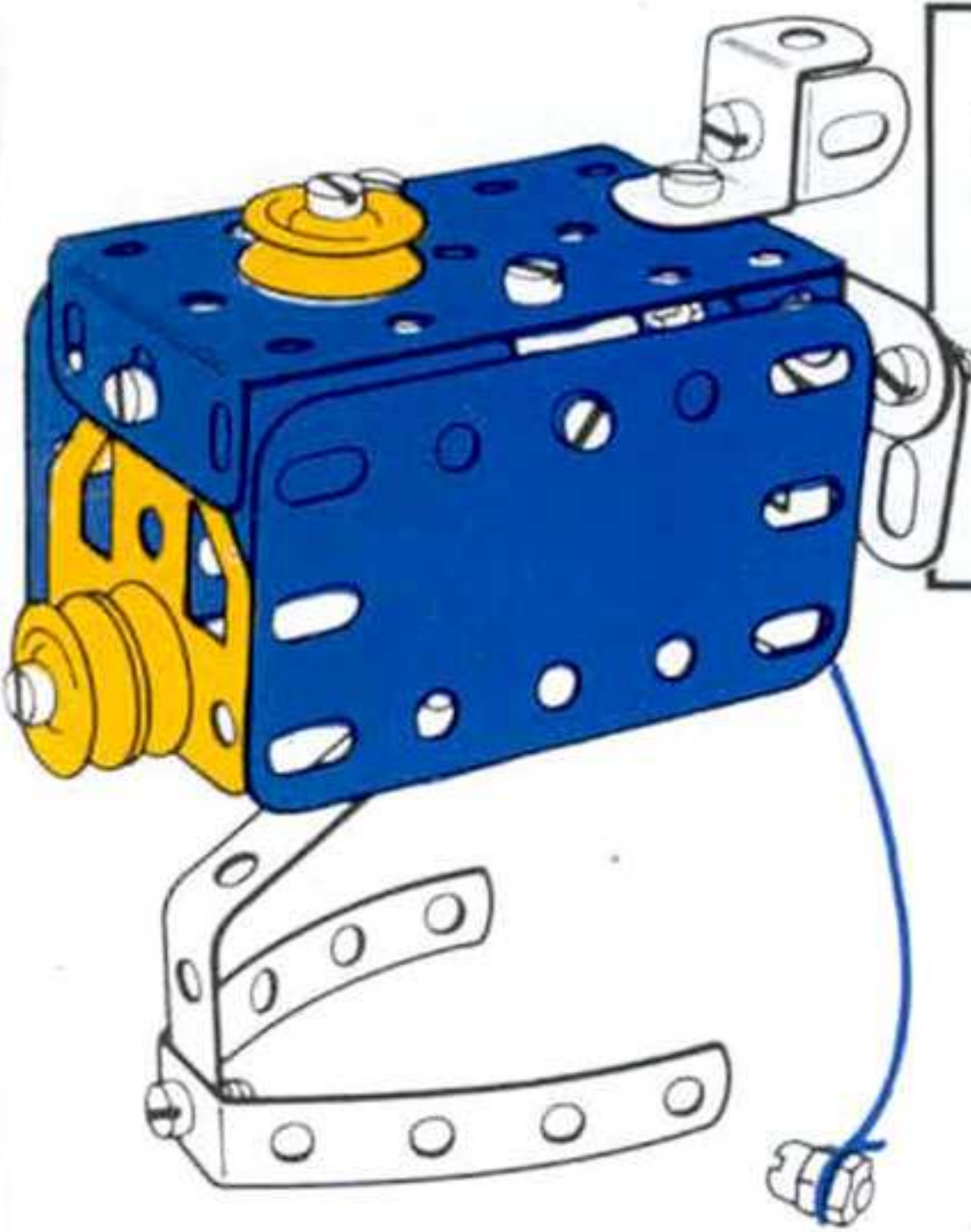

CRANE

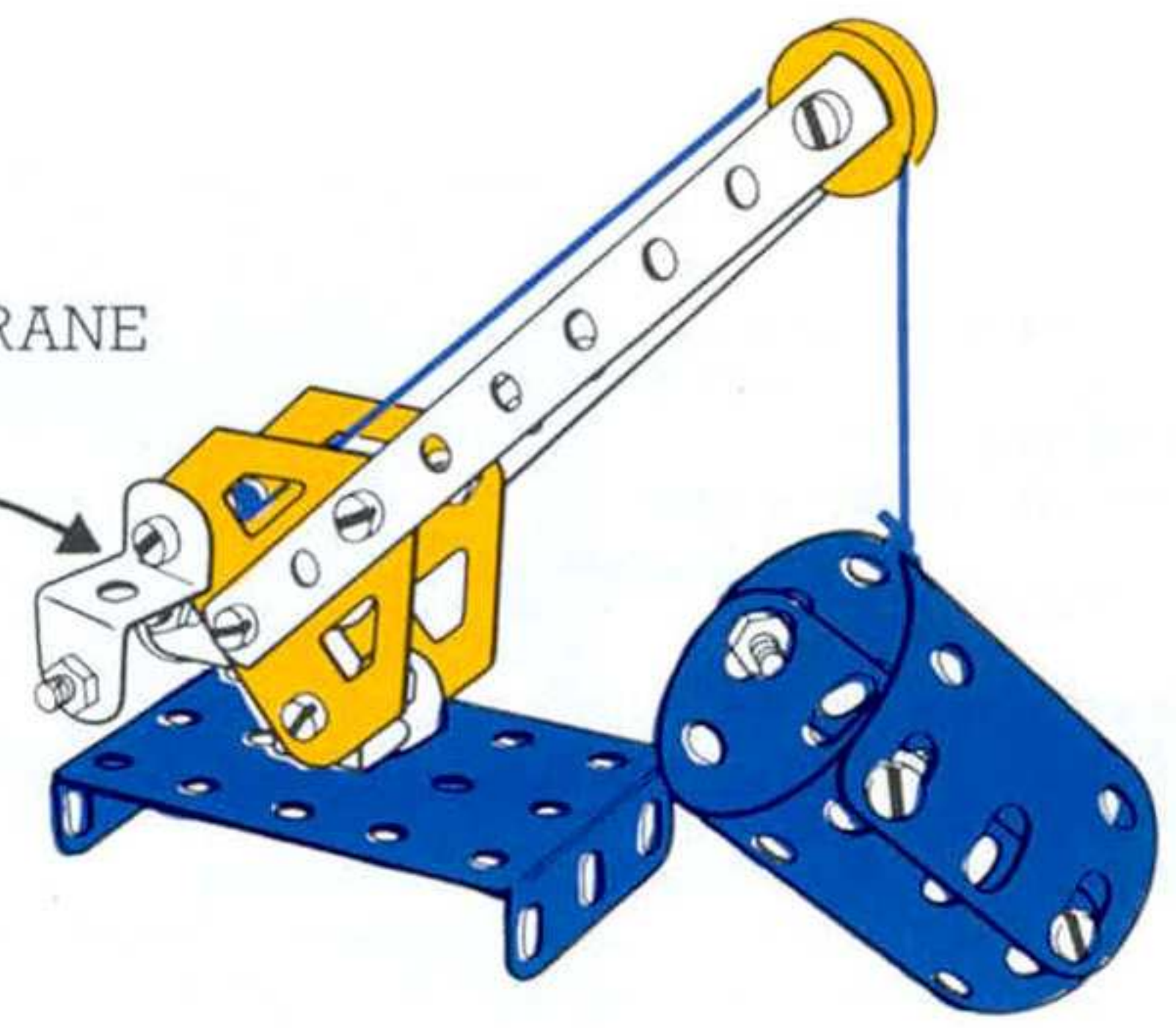
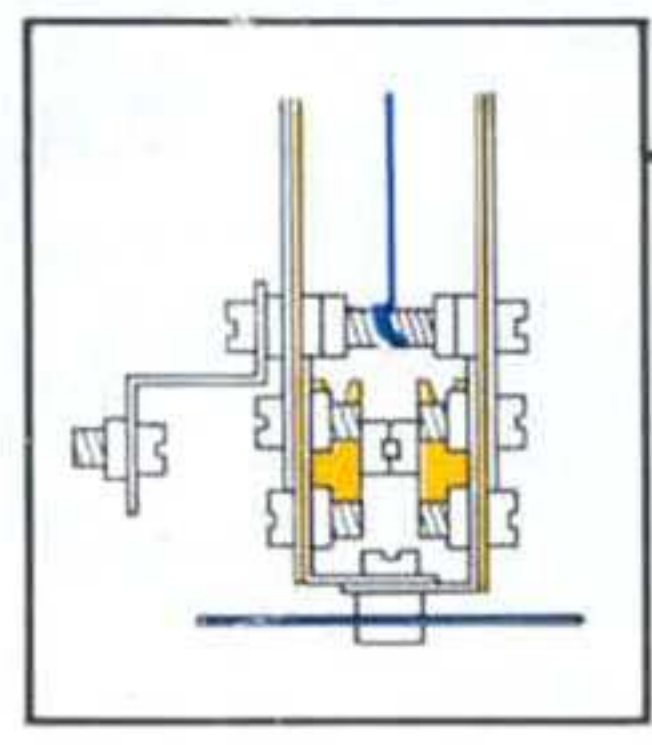

GUILLOTINE

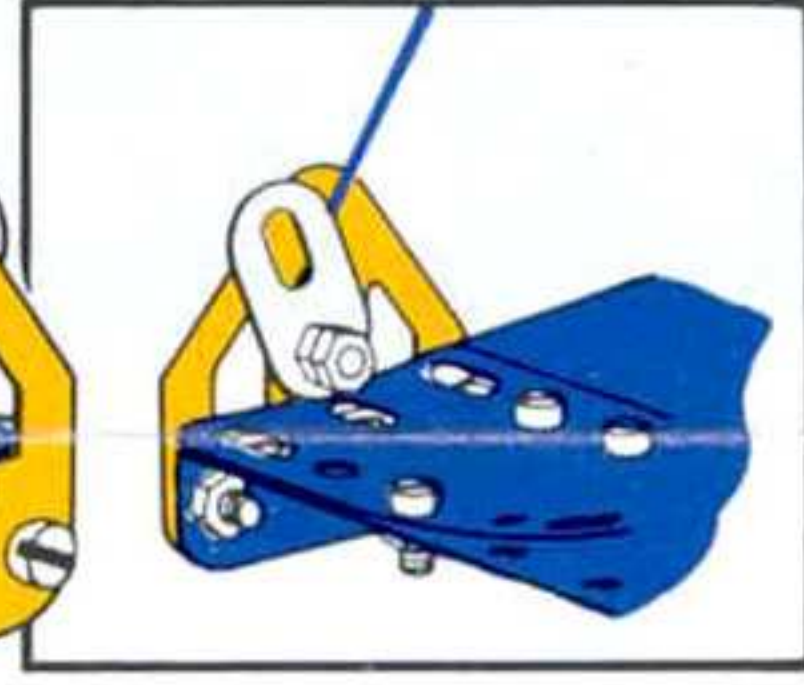
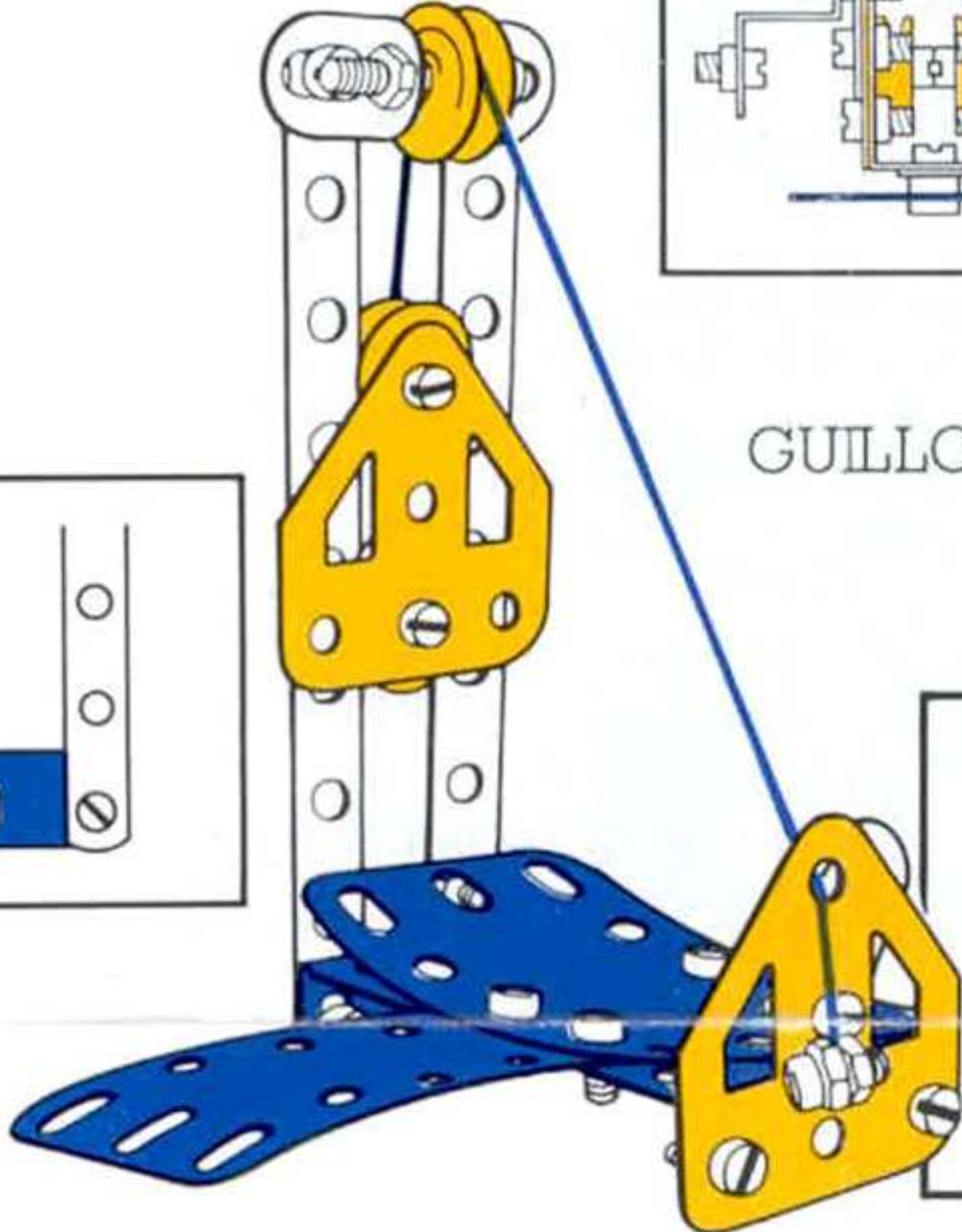
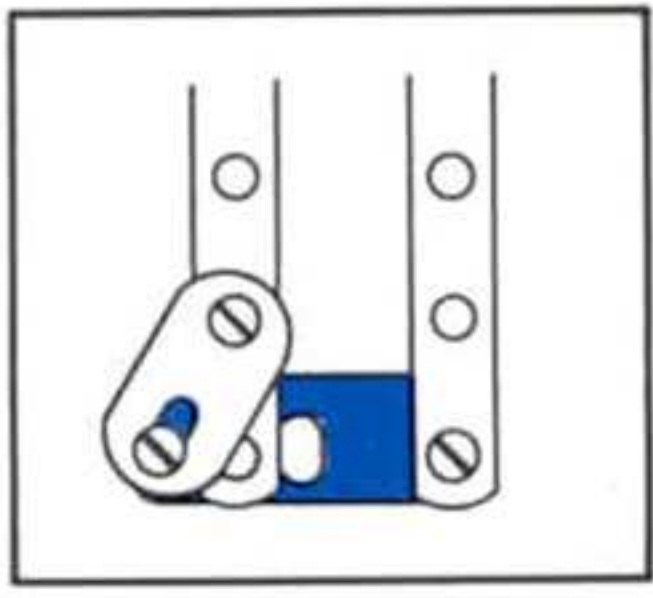

"TEST-YOUR-STRENGTH" MACHINE

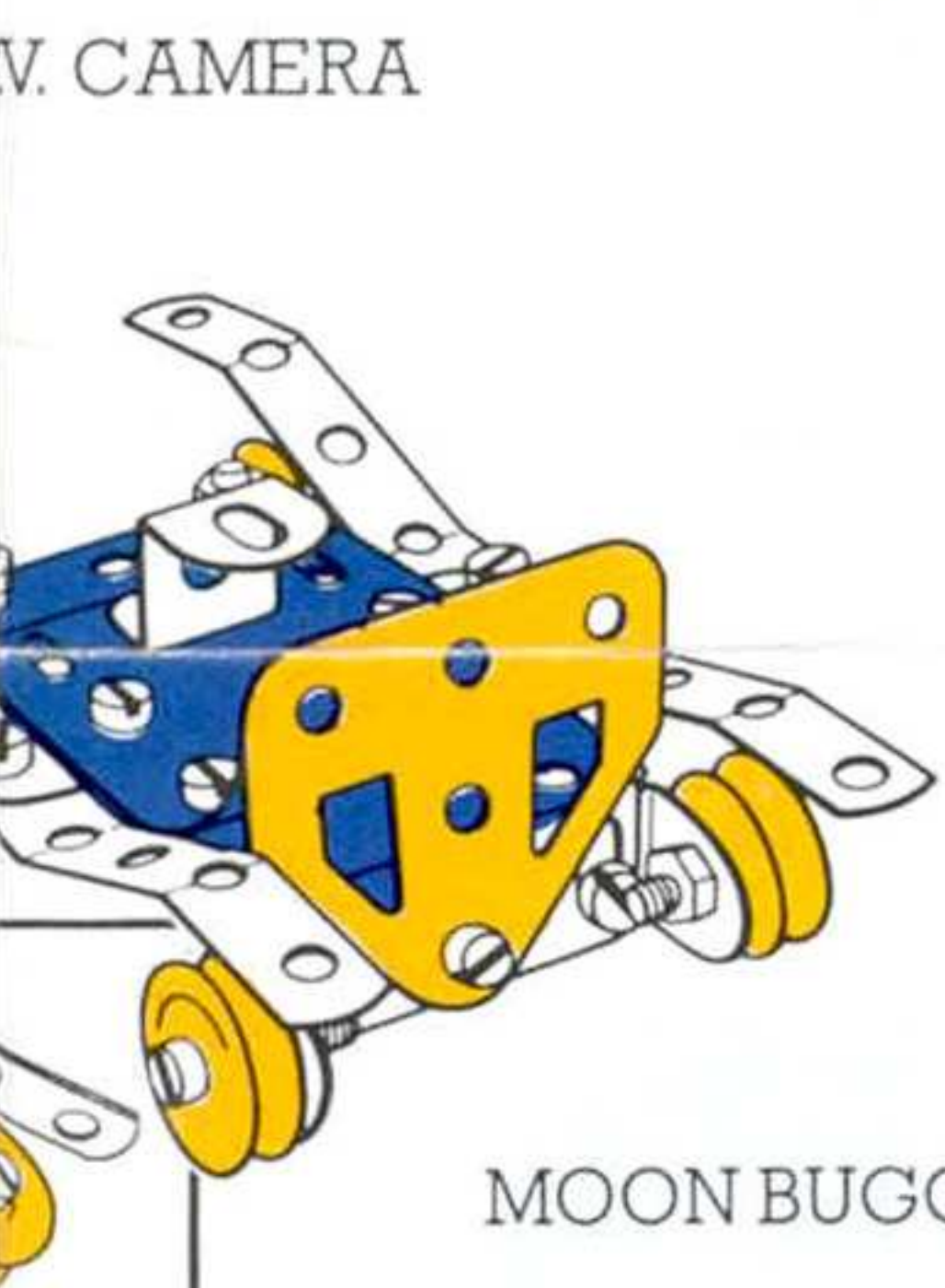
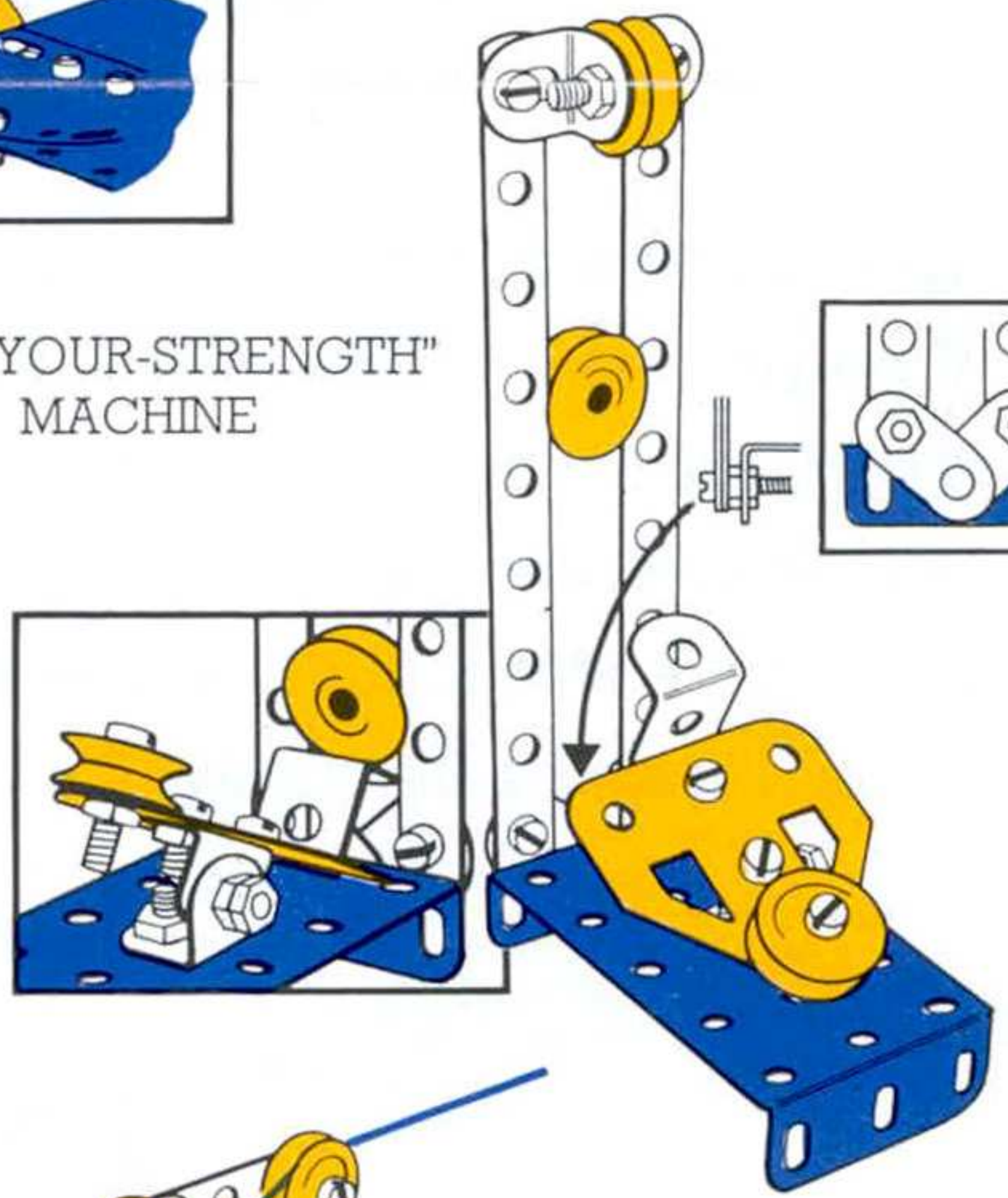

MOON BUGGY

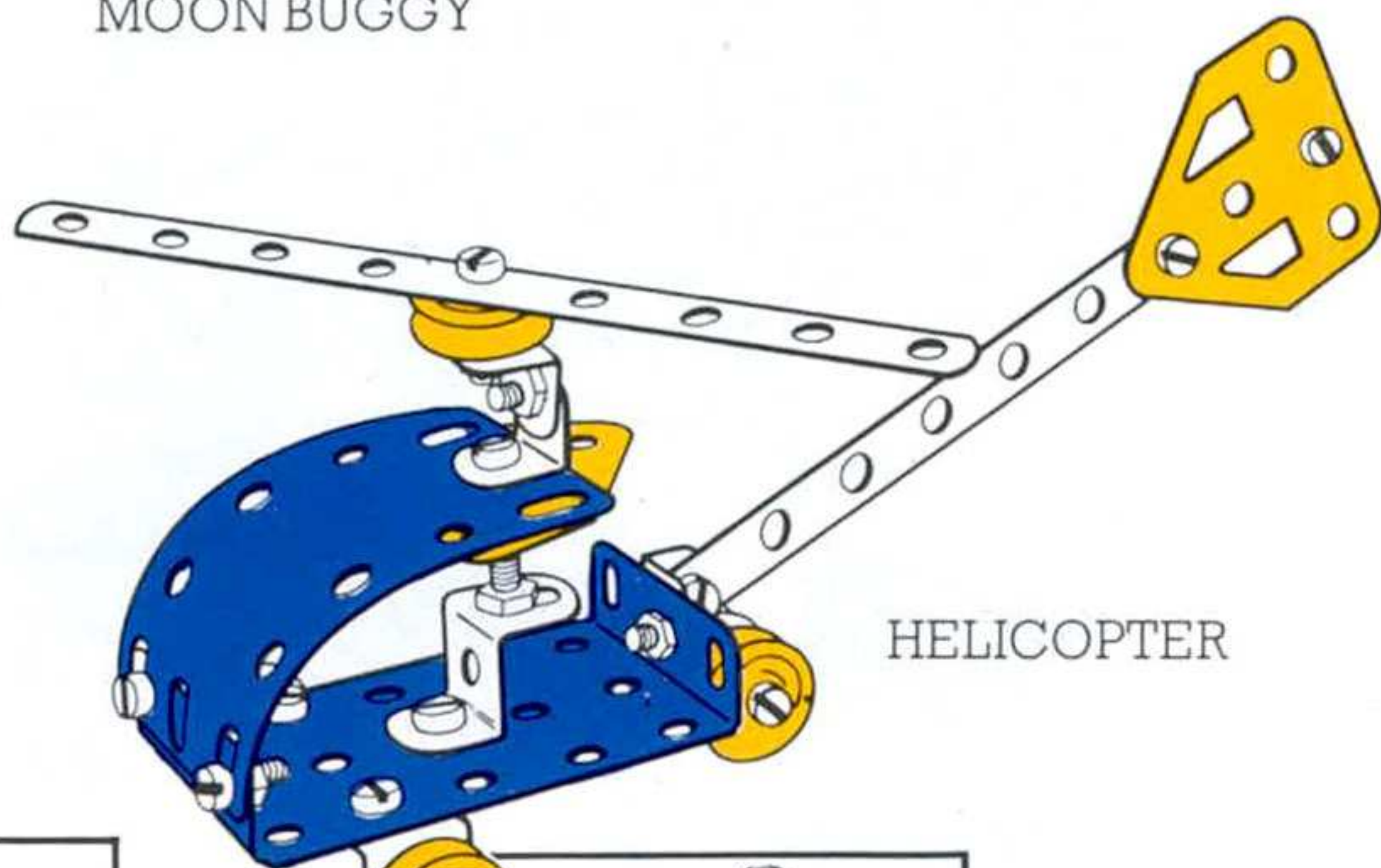

HELICOPTER

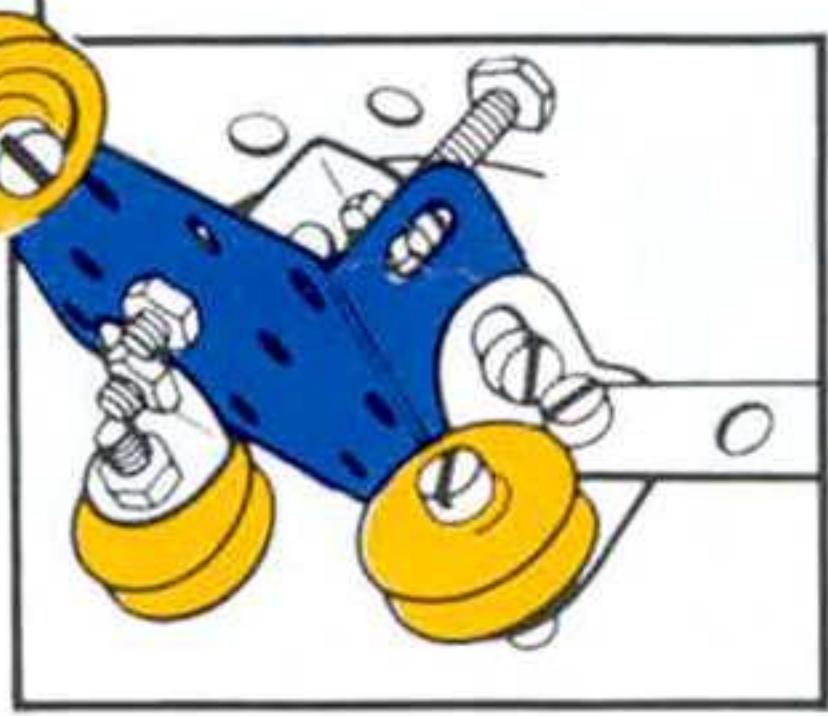
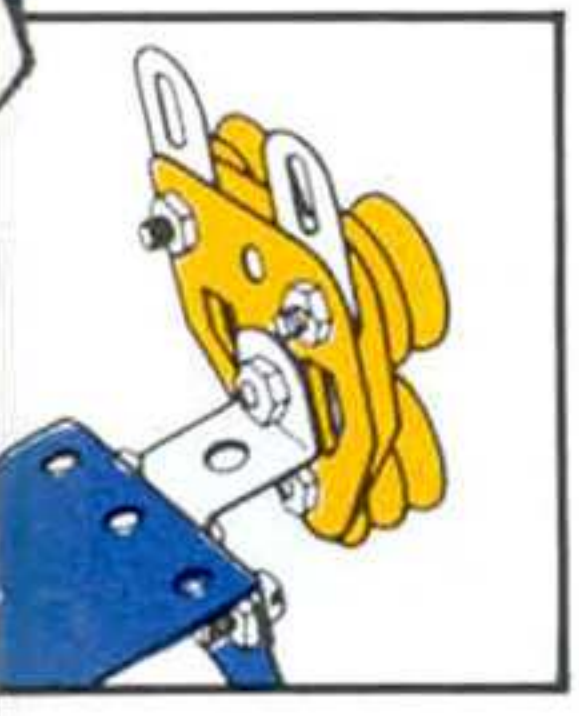

CABLE CAR

