

MECCANO 1929 BOOK OF NEW MODELS

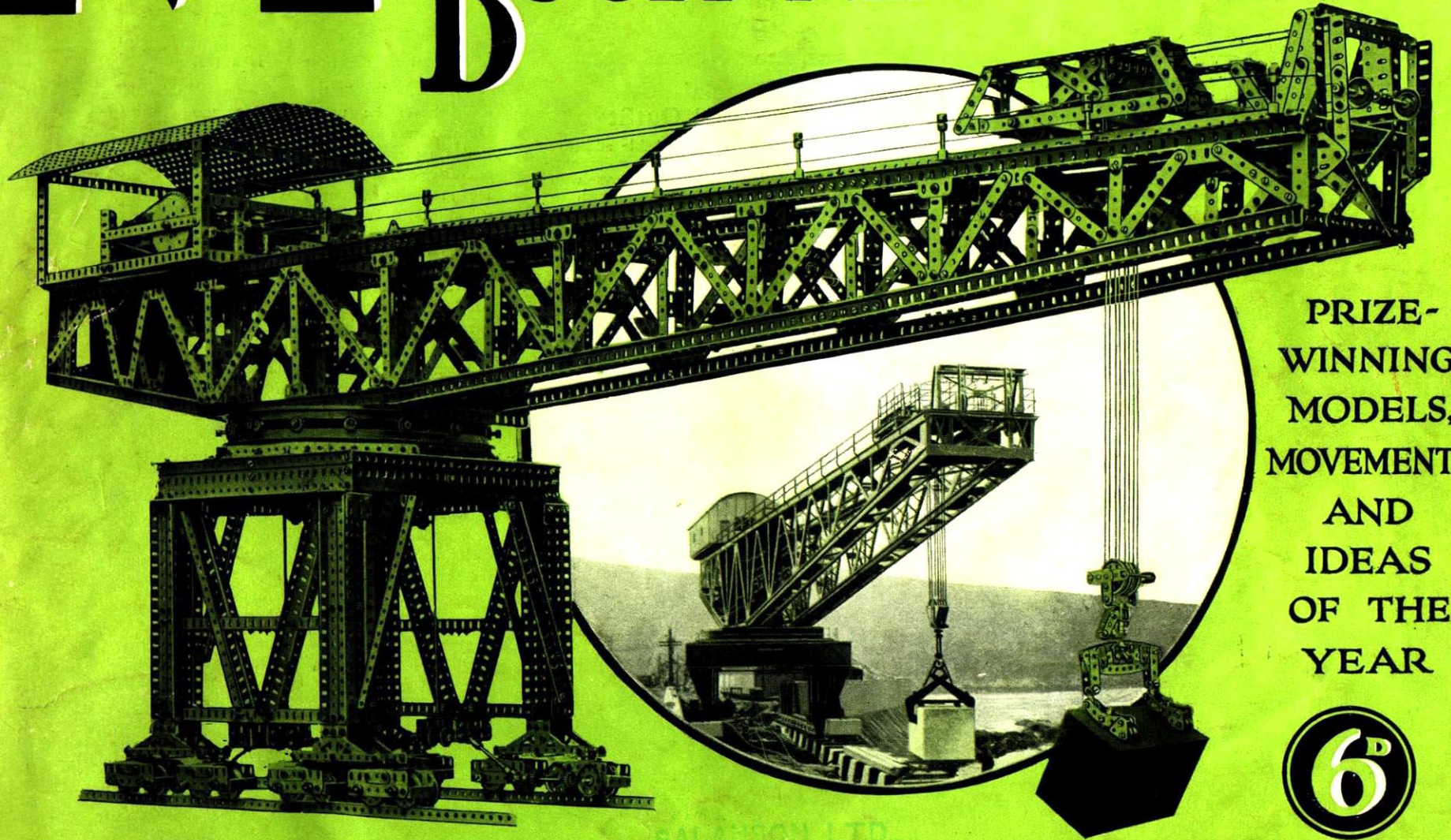

PRIZE-
WINNING
MODELS,
MOVEMENTS
AND
IDEAS
OF THE
YEAR

6^d

SALMON LTD.
20, JOHN ST.
BRISBANE

GIANT
TURNING, BORING
AND
BOSSING LATHE

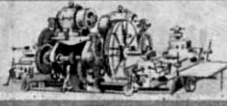

ELECTRIC TRAIN



SUBMARINE



HIGH PRESSURE
TURBINE



The Joy of Inventing!

THE FIRST-PASSENGER LOCOMOTIVE



THE FLYING SCOTSMAN.



CUGNOT'S ROAD VEHICLE



MODERN RACING CAR



ENGINE OF EARLY STEAMBOAT



INVENTING new models and movements in Meccano is a most fascinating pastime, as every Meccano boy knows. There is nothing in the world comparable with the joy and satisfaction of creating something new.

Never before has there been such a great opportunity for inventors. Every trade, no matter how humble or how elevated it may be, has need of the best machines to enable it to meet competition among the nations of the world. Every little improvement or new method of construction that will allow of lower manufacturing costs is eagerly welcomed.

Before the invention of Meccano, the boy who desired to learn something of the wonders of engineering had to gain his knowledge from text books, and perhaps spend hours of study with very little profit to himself as far as learning was concerned. But Meccano has changed all this, and the boy of to-day can immediately commence to build models of practically every known engineering device. Moreover, he can make working models from his own

Special Inventors' Outfit

This outfit makes a valuable addition to any keen model-builder's equipment. It is intended specially for boys who already have Meccano and who wish to satisfy their inventive inclinations by building models from their own designs. The parts contained include four large Pulley Wheels with Dunlop Tyres, Ball Race, Ship's Funnel, Pulley Blocks, Channel Bearing, Crane Grab and many others.

Price 17/6



ideas, and all the time he is a real engineer in miniature.

Whenever he uses his Meccano Outfit new ideas come to him. He builds a piece of intricate mechanism and discovers the secrets of its working. He gradually accumulates so much valuable knowledge of mechanics and engineering that he is able to develop new ideas and put them into practice.

Every Meccano boy should try his hand at inventing, and as soon as he succeeds in producing a new model he should enter it in one of the Meccano Model-building Competitions announced from time to time in the "Meccano Magazine." Large numbers of new models, suggestions, and bright ideas reach us each day in connection with these competitions, and in order to show Meccano boys what has been done already and to provide ideas for future use, we have included in this book a selection of the most outstanding prize-winning efforts that have been received recently. Several of the models shown are published for the first time.

WRIGHT'S GLIDER

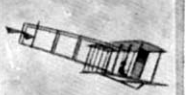

SUPERMARINE NAPIER 'SEAPLANE



AN EARLY 'AEROSTAT



DIRIGIBLE AIRSHIP



EARLY STEAMBOAT



GIANT MARINE ENGINE



EARLY TRIP HAMMER



1200-TON PRESS

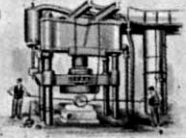

HAND LOOM OF 1825



MODERN
LOOM



H.M.S. NELSON.



NEW MECCANO MODELS

Model No. 1 Bicycle Carrier

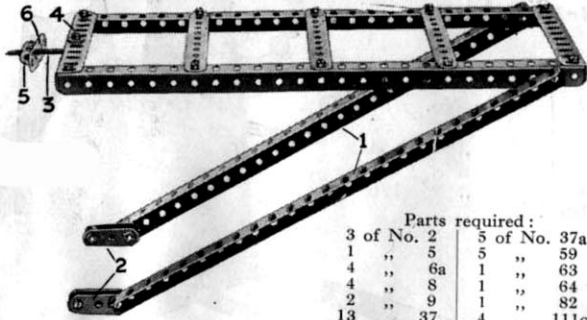

Parts required:

3 of No. 2	5 of No. 37a
1 " 5	5 " 59
4 " 6a	1 " 63
4 " 8	1 " 64
2 " 9	1 " 82
13 " 37	4 " 111c

Two 12½" Girders 1 are fitted at their lower ends with 1½" Strips 2 and 4" Bolts with which they are clamped to the rear forks of the bicycle frame. The other connection to the cycle is effected by means of a 2" Threaded Rod 3, which is inserted in a Threaded Boss secured to the 5½" Angle Girder by means of the bolt 4. The latter enters the transverse bore of the Threaded Boss and grips the Rod 3. A Coupling 5 is used as a wing nut and clamps the framework of the cycle between the 2½" Strip 6 and the end of the carrier.

Model No. 4 Fire Escape

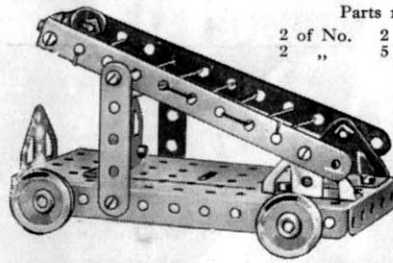

Parts required:

2 of No. 2	2 of No. 10
2 " 5	4 " 12
	2 " 16
	4 " 22
	16 " 37
	6 " 37a
	1 " 48a
	1 " 52
	4 " 111c
	2 " 126
	2 " 126a

Model No. 8 Breakdown Crane

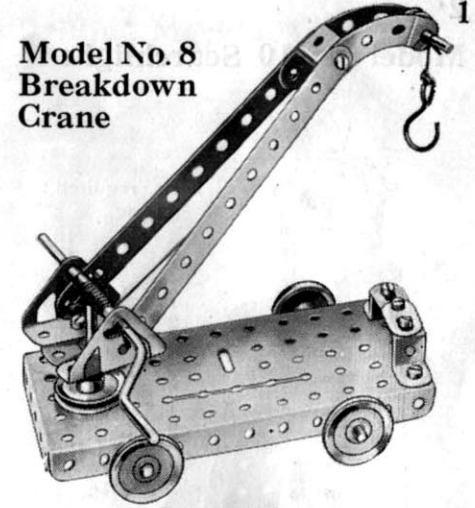

Parts required:

2 of No. 2	1 of No. 19s	1 of No. 48a
2 " 10	4 " 22	1 " 52
1 " 11	1 " 23	1 " 57
2 " 16	1 " 24	2 " 90a
1 " 17	3 " 35	2 " 125
1 " 18a	11 " 37	2 " 126

Model No. 2 Catapult

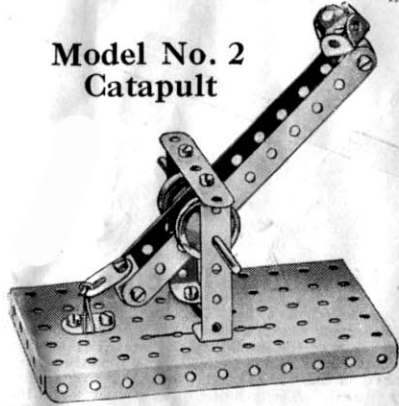

Parts required:

2 of No. 2	2
1 " 5	5
2 " 10	10
2 " 11	11
5 " 12	12
1 " 16	16
2 " 22	22
12 " 37	37
2 " 48a	48a
1 " 52	52
Small Piece	
Elastic	

Model No. 5 Coal Cutting Machine

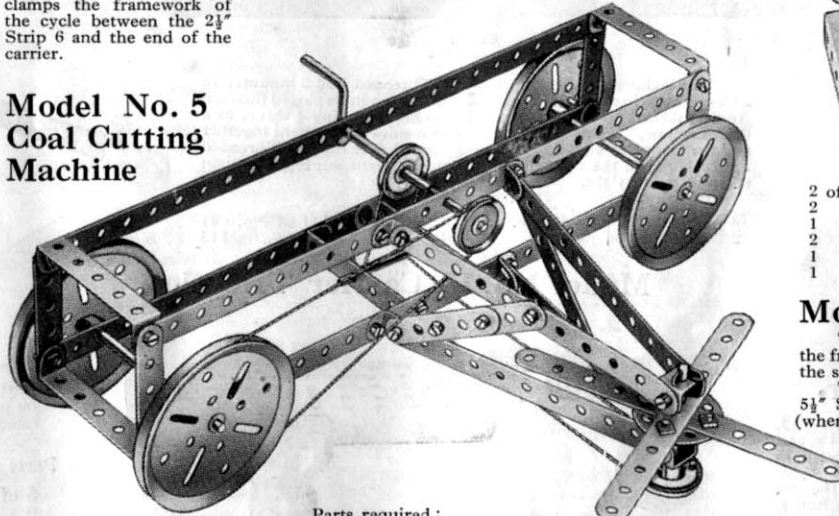

Parts required:

4 of No. 1	6 of No. 5	2 of No. 16	4 of No. 19b	5 of No. 35
6 " 2	2 " 11	1 " 17	1 " 19s	34 " 37
1 " 3	4 " 12	1 " 18a	3 " 22	6 " 48a

Model No. 9 Meccano Puzzle

The problem, which is to remove the Strip 2 from the frame, is by no means an easy one to solve. Cutting the string or undoing the knot is not allowed! The loop of string 1 attached to the end of the 5½" Strip 2 should reach half way along the Strip 2 (when removed from the frame). To assemble the puzzle first pass the loop over the points 3, 4 and 5 and then slip it down to the T runnion 6. Next pass the 5½" Strip 2 through the space 7 and again take the loop over 3, 4 and 5. The loop 1 and Strip 2 are now attached to the frame as shown in the illustration.

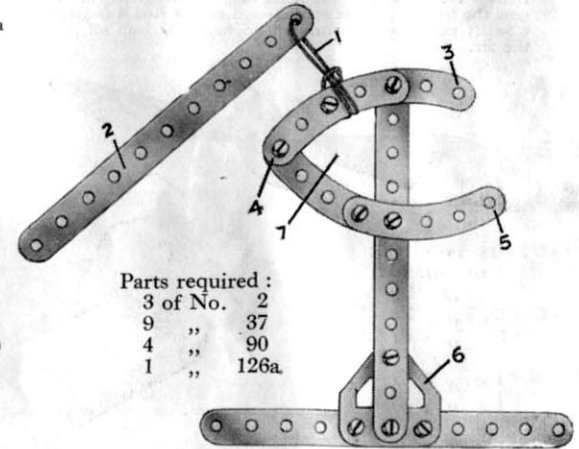

Parts required:

3 of No. 2	2
9 " 37	37
4 " 90	90
1 " 126a	126a

Model No. 3 Accumulator Carrier

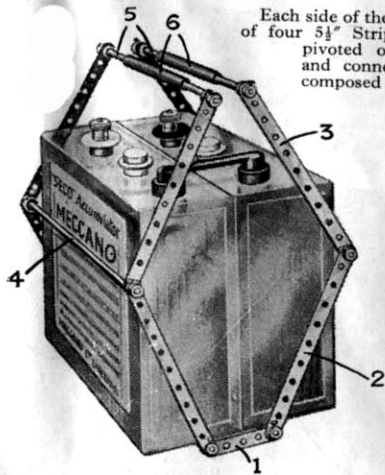

Each side of the carrier is formed of four 5½" Strips 2, 3 that are pivoted on Axle Rods 4 and connected to a base composed of two Axle Rods connected together at their lower ends by means of 2½" Strips 1. The handles are formed by Axle Rods 5, and may be covered with rubber tubing 6 if desired. All the Rods are held in position by Collars.

Parts required:

8 of No. 2	2
2 " 5	5
6 " 14	14
24 " 59	59
8 " 63	63

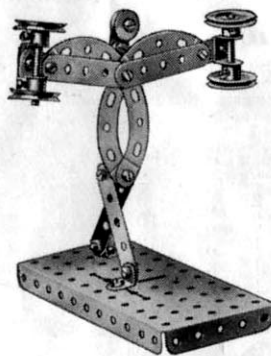

Model No. 6 Strong Man

Parts required:

4 of No. 5	5
4 " 10	10
2 " 11	11
4 " 12	12
2 " 18a	18a
4 " 22	22
1 " 23	23
13 " 37	37
1 " 37a	37a
4 " 90a	90a
1 " 111c	111c

Model No. 7 The Execution

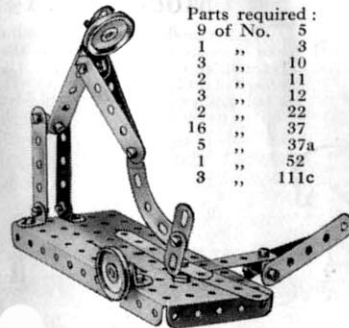

Parts required:

9 of No. 5	5
1 " 3	3
3 " 10	10
2 " 11	11
3 " 12	12
2 " 22	22
16 " 37	37
5 " 37a	37a
1 " 52	52
3 " 111c	111c

Model No. 10 Searchlight

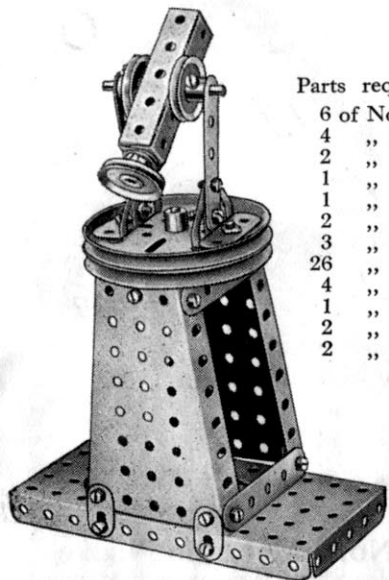

Parts required :

6 of No.	5
4 "	10
2 "	12
1 "	17
1 "	18a
2 "	19b
3 "	22
26 "	37
4 "	48a
1 "	52
2 "	54
2 "	126

Model No. 12 Tie Press

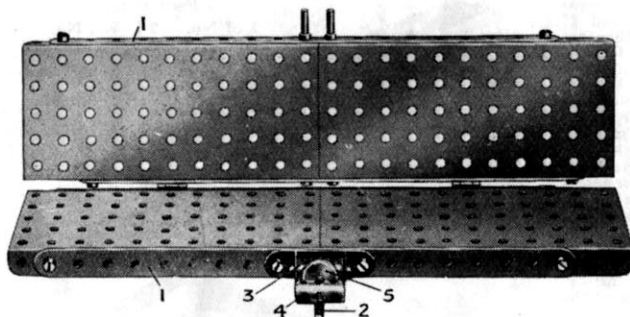

The locking device comprises a 2" Threaded Rod 2 mounted in a Coupling 3 that is secured to the shanks of two Bolts passed through Angle Brackets to form pivots. The other Coupling 4 serves as a thumb-screw. To use the press, the two sides are brought together and the Coupling 4 and the Pulley 5 slipped over the two Threaded Pins secured in the upper pair of Plates. The Coupling 4 is then screwed down tight.

Parts required :

4 of No.	1a	22 of No.	37	1 of No.	59	1 of No.	81
2 "	12	4 "	52	1 "	63	2 "	115

**Model No. 15
Coco-nut Shy**

Parts required :

2 of No.	1	32 of No.	37
1 "	2	1 "	52
3 "	5	2 "	54
2 "	11	2 "	125
8 "	12	2 "	126
	8 Steel Balls		

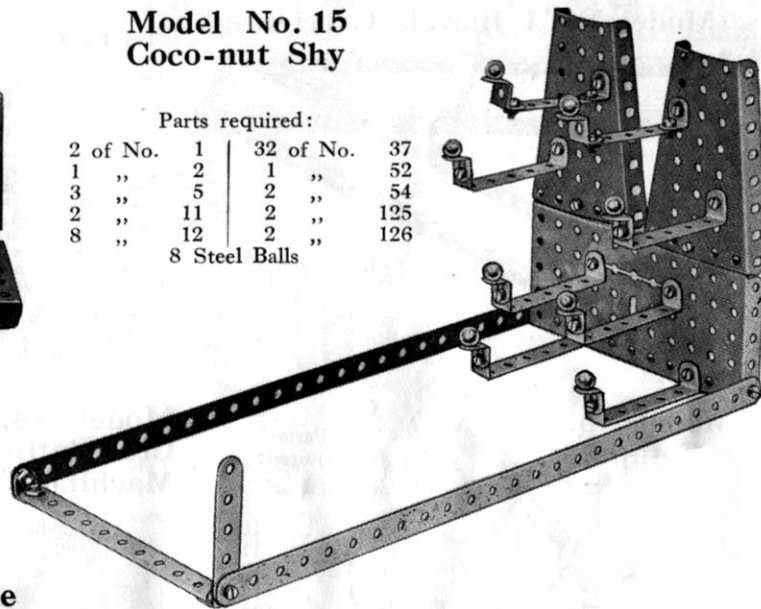

Model No. 11 Helicopter,

The Bush Wheel 3 and the two Flanged Wheels 5, which act as a flywheel, are all secured to the 4 1/2" Rod 4, and the latter is journaled in a 2 1/2" x 1 1/4" Double Angle Strip, in which it is retained by a Collar 6. The Double Angle Strip forms a convenient handle with which to hold the toy.

A piece of cord about 24" long is wound on the Rod 4. The propeller 1 should be placed so that the shanks of the Bolts 2 lodge freely in the holes of the Bush Wheel 3. If now the free end of the cord wound on the Rod 4 is given a smart pull, the propeller will immediately leap off into the air.

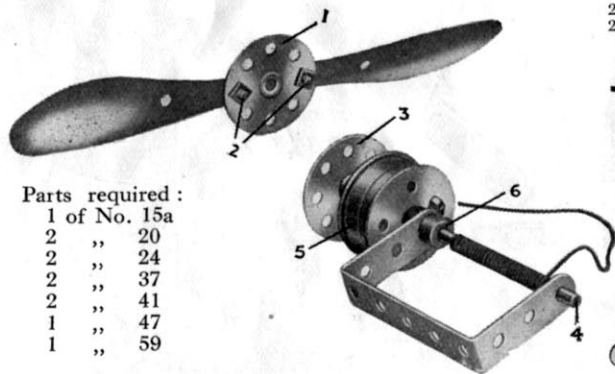

Parts required :

1 of No.	15a
2 "	20
2 "	24
2 "	37
2 "	41
1 "	47
1 "	59

Model No. 13 Carrier Tricycle

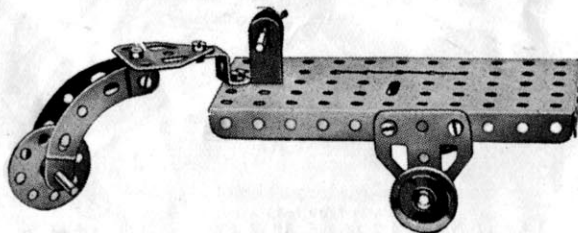

Parts required :

1 of No.	11	1 of No.	24	1 of No.	37a	2 of No.	90a
1 "	16	2 "	35	1 "	44	1 "	126
2 "	18a	10 "	37	1 "	52	2 "	126a
2 "	22						

Model No. 14 Pecking Hen

Alternately pushing and pulling on the lower 5 1/2" Strip causes the hen to make vigorous pecks at the "bowl." One leg only is attached pivotally to the two 5 1/2" Strips, which are kept parallel to each other by means of a Flat Bracket that also is connected pivotally to each Strip by a bolt and two nuts (Standard Mechanism No. 262).

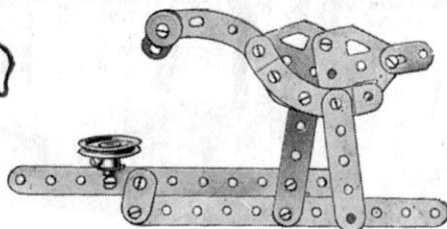

Parts required :

2 of No.	2
2 "	5
3 "	10
1 "	12
1 "	22
1 "	23
11 "	37
5 "	37a
2 "	90a
2 "	126a

Model No. 16 Motor Tractor

The front wheel axle is journaled in a 2 1/2" x 1 1/4" Double Angle Strip, to the centre of which two Reversed Angle Brackets are bolted and these are connected pivotally to the end hole of the lower Sector Plate. The steering column is journaled in a hole in the base Flanged Plate and in a Reversed Angle Bracket bolted to the Plate. Its lower end carries a 1" Fast Pulley Wheel. A length of cord is passed round this Pulley and its ends are attached to each end of the Double Angle Strip that carries the front wheels.

Parts required :

5 of No.	5
2 "	12
3 "	16
1 "	17
2 "	19b
4 "	22
1 "	24

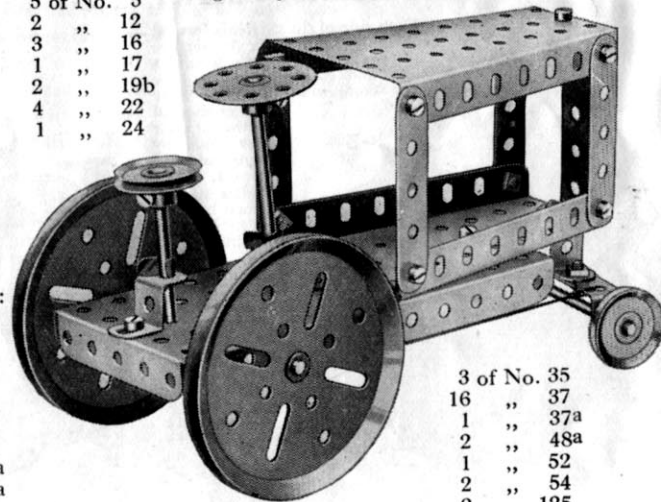

3 of No.	35
16 "	37
1 "	37a
2 "	48a
1 "	52
2 "	54
2 "	125

Model No. 17 Recording Caliper Gauge

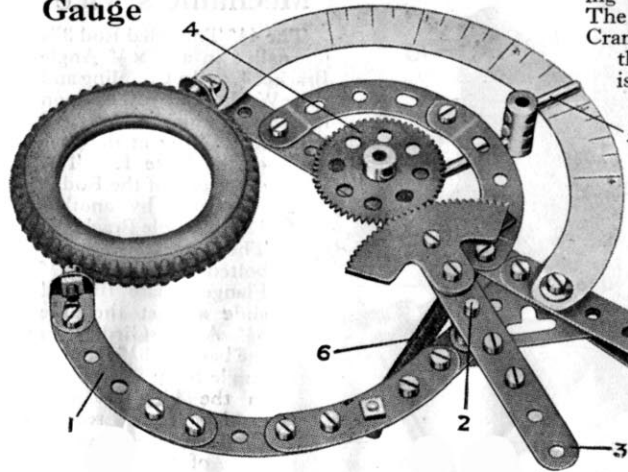

This model is designed for measuring the outside diameter of objects. The moving arm 1 is secured to a Crank that is fixed by its set-screw to the 1" Rod 2. Secured to the Rod 2 is another Crank that is bolted to a 3 1/2" Strip 3. Two Rack Segments placed one upon the other and bolted to the end of the Strip 3 mesh with the 57-teeth Gear 4. The latter is fastened on a 1" Rod journalled in a Double Arm Crank that is bolted to the 5 1/2" Strip.

On the lower end of this Rod a Coupling is secured and in its longitudinal bore is gripped a 2 1/2" Rod. This Rod forms the longer portion of the pointer 5. The latter is returned to normal by means of a

Spring 6, that is attached at one end to the arm 1 and at its other end to a bolt on the handle portion of the instrument.

Parts required :

1 of No. 2	3 of No. 18b	1 of No. 38	2 of No. 63	3 of No. 111c
3 " 3	1 " 27a	1 " 43	3 " 90	2 " 129
2 " 12	22 " 37	2 " 62	2 " 90a	1 " 133
1 " 17	4 " 37a	1 " 62b		

Model No. 18 Square Hole Drilling Machine

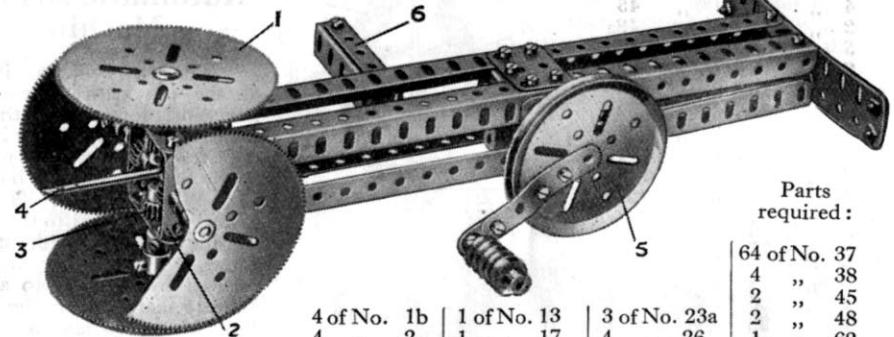

Parts required :

4 of No. 1b	1 of No. 13	3 of No. 23a	64 of No. 37
4 " 2	1 " 17	4 " 26	4 " 38
1 " 5	4 " 18a	4 " 27b	2 " 45
2 " 9f	1 " 19b	1 " 28	2 " 48
1 " 11	3 " 2	2 " 30	4 " 62
			4 " 62b
			2 " 103
			8 " 103h

This model represents a tool specially designed for drilling square holes. Four 1 1/2" Strips are bolted in the form of a square between the bottom ends of the 7 1/2" Angle Girders, each Strip having a Double Arm Crank bolted to it. These latter form bearings for 1 1/2" Rods to which are secured four 3 1/2" Gear Wheels 1 representing the saws. On the inner end of each of these Rods a 1/2" Pinion is secured and all the Pinions engage with a 1 1/2" Contrate Wheel on the Rod 4, which is journalled in the centre of the model in 1 1/2" x 1/2" Double Angle Strips. A 1" Bevel secured at the top end of the Rod 4 engages a second Bevel on the Rod of the Pulley 5.

Model No. 19 Testing Machine

Machines used to determine the strength of materials are known as testing machines, and with their aid metals or timbers, etc., may be subjected to compressive, tensile, or bending stresses.

In this model, the jaws of the machine, which grip the specimen to be tested, are formed by a Threaded Coupling 1 and an ordinary Coupling 2 secured to 3 1/2" Rods. These Rods carry at each end a 1/2" loose Pulley mounted between Collars, and the Pulleys are guided between the edges of two parallel 12 1/2" Angle Girders. The Coupling 1 is fastened to the end of a 3 1/2" Threaded Rod 3, and this is gripped by two nuts in the centre holes of two Threaded Cranks 4. The Cranks are mounted on two parallel 3 1/2" Threaded Rods 5, which are inserted at each end in Threaded Couplings 6. Two pairs of 1" Rods inserted in the other ends of the Couplings 6 form the journals on which the Threaded Rods 5 turn.

The Threaded Rods 5 are rotated simultaneously by means of two Worm Wheels secured to a 3 1/2" Rod 7. The latter Rod is journalled in a 3 1/2" x 1/2" Double Angle Strip bolted to the rear upright 3 1/2" Angle Girders of the frame, and it is rotated by means of Sprocket Chain

drive 8 from a shaft 9 that is driven from a 6-volt Electric Motor through a gear train consisting of two 1/2" Pinions and two 57-teeth Gear Wheels.

The jaw 2 of the machine is secured to a 1 1/2" Axle Rod sliding in the centre hole of a 2 1/2" x 1/2" Double Angle Strip that is secured transversely in the framework of the model, and an End Bearing secured to this Rod is attached pivotally to the second hole of a Boss Bell Crank 10. This Crank pivots on the Rod 11 and its other arm is extended by a 4 1/2" Strip 12 that is connected pivotally to a 2 1/2" Strip 13, the other end of which is pivotally attached to the end of a Crank 14 secured to the 3 1/2" Rod 15.

The Rod 15 carries a Coupling, and a 3 1/2" Rod 16 secured in this forms a pointer to record the force exerted by the machine. The movement of the pointer is controlled by two short lengths of Spring Cord, secured at one end to the pointer between the Coupling and the Collar 22 and at the other end to a 1/2" Bolt inserted in Angle Brackets 2.

Preliminary adjustment of the jaws is effected by a hand wheel 17, which engages with a 3/4" Pinion on the Rod 7.

Parts required :

1 of No. 2a	6 of No. 16
2 " 3	1 " 17
1 " 5	1 " 18a
1 " 6	4 " 18b
6 " 6a	5 " 23a
2 " 7a	1 " 25
4 " 8	2 " 26
4 " 9b	5 " 27a
1 " 9d	2 " 32
2 " 12	71 " 37a
2 " 15a	60 " 37b

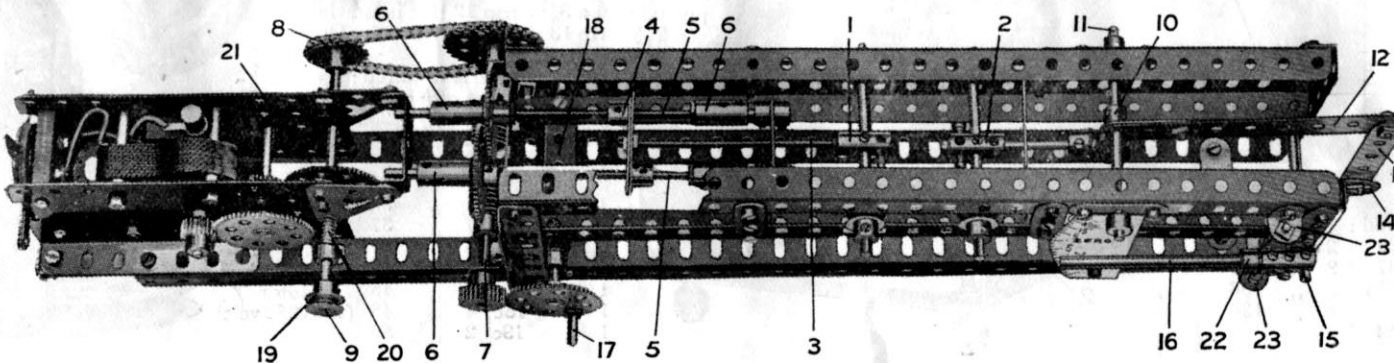

Parts required (con.):

8 of No. 38	3 of No. 80a
1 " 48	9 " 94
3 " 48a	1 " 95a
1 " 48b	1 " 96
2 " 58	2 " 111a
19 " 59	1 " 115
1 " 62	1 " 120b
2 " 62a	1 " 128
2 " 63	2 " 133
5 " 63c	1 " 166
1 6-volt Electric Motor	

Parts required:

2 of No. 4	1b	1 of No. 43
4 "	2	1 "
4 "	4	6 "
5 "	5	2 "
2 "	8	1 "
2 "	10	2 "
6 "	12	4 "
1 "	13a	2 "
3 "	18b	1 "
1 "	19b	2 "
1 "	21	
2 "	22	
2 "	22a	
3 "	24	
2 "	26	
1 "	28	
62 "	37	

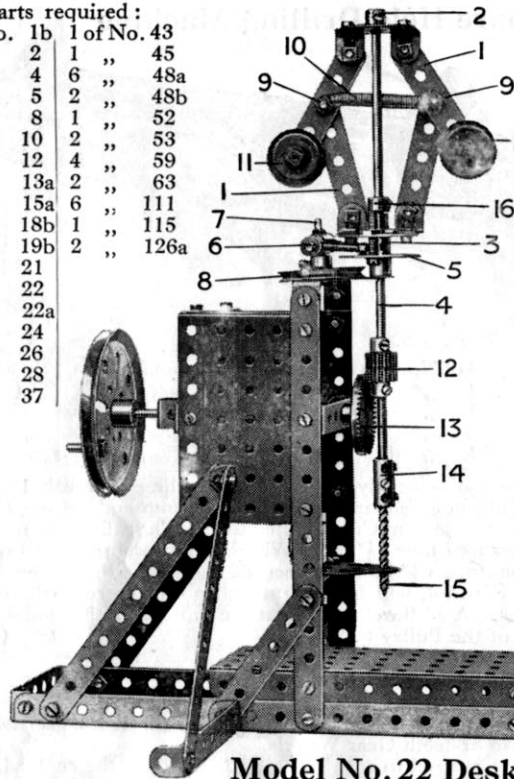

Model No. 20 Automatic Drilling Machine

The Drill Spindle 4 is fitted at the top with a centrifugal governor, formed by the two pairs of 2 1/2" Strips 1 pivotally attached by bolts and nuts to Angle Brackets that are bolted to Bush Wheels 2 and 3. The Bush Wheel 2 is secured to the Rod 4 but the Wheel 3 is without a set-screw. The latter wheel is secured by 3/4" Bolts to a Bush Wheel 5 that is free on the Rod 4. Both Wheels 3 and 5 are prevented from moving vertically by 3/8" Bolts inserted in place of the set-screws in two Collars 6, which are held fast on 1" Rods inserted in opposite ends of a Coupling that is secured to a Rod 7. The latter is gripped in the boss of a 1 1/2" Pulley 8, which is rigidly bolted to a 2 1/2" x 1/2" Double Angle Strip at the top of the framework. The two pairs of 2 1/2" Strips 1 are attached pivotally to each other by bolts 9. A Spring 10 tends to draw inward the weights 11, which consist of 1" fixed and 1" loose Pulleys bolted together.

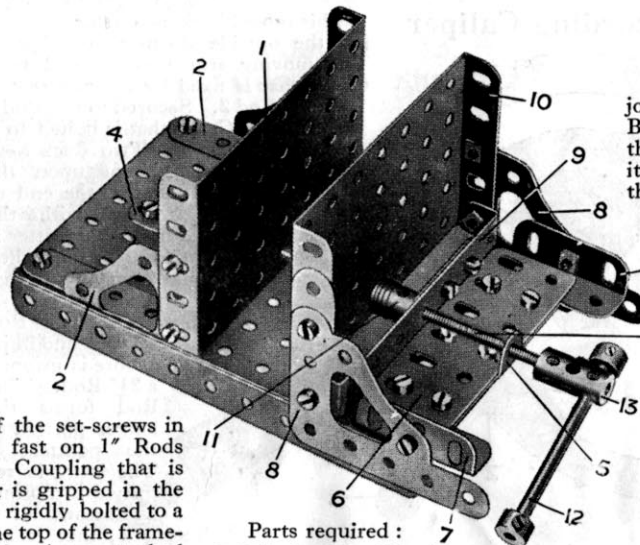

Model No. 21 Mechanic's Vice

The 4 1/2" Threaded Rod 3 is journalled in a 1" x 1/2" Angle Bracket 4, and a Coupling and three Washers are placed upon it between this bracket and the Angle Girder at the base of the Plate 1. The other end of the Rod is supported by another 1" x 1/2" Angle Bracket 5. The Architraves 8 are bolted to a 3 1/2" x 2 1/2" Flanged Plate 10, and slide against the side 5 1/2" Angle Girders in the base. A 3 1/2" Double Angle Strip 9 is bolted to the Plate 10 and carries a Threaded Crank 11, the threaded bore of which is engaged by the Rod 3.

Parts required:

2 of No. 9	24 of No. 37	2 of No. 53	1 of No. 63	2 of No. 108
2 "	9f	4 "	1 "	1 "
1 "	12b	1 "	48b	1 "
1 "	16a	1 "	52a	133
		1 "	62a	2 "
				103d
				133a

Model No. 23 Oscillating Electric Fan

The fan unit is mounted on bearings consisting of fourteen Steel Balls arranged round the circumference of a Bush Wheel bolted to the interior of a Wheel Flange 1, which in turn is bolted to a Double Bent Strip 3 carried on a 3/4" Bolt in the top of the 5 1/2" vertical Girders. The unit turns on a Pivot Bolt passed through the centre hole of the 5 1/2" x 2 1/2" Flat Plate 4 and secured in the boss 2 of the Bush Wheel.

A Pulley 5 on the Motor armature transmits motion to a 2" Pulley 6 by means of Meccano Spring Cord, and a Worm engages with a 1/2" Pinion on the Rod 7 that carries a 1/2" Pinion 8. A 57-teeth Gear 9 is secured to a Pivot Bolt passed through the Plate 4. The bolt also carries a Crank 10, which is secured to the Wheel 9 by the 1/2" Bolt 11, and connected pivotally to a 3 1/2" Strip 12 that is attached to a 2 1/2" Strip 13 rigidly bolted to the Double Bent Strip 3.

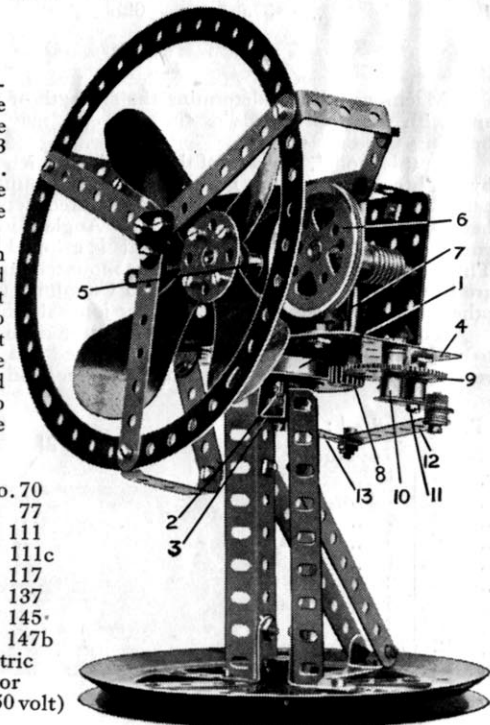

Parts required:

2 of No. 2a	1 of No. 20a	1 of No. 70
6 "	3 "	1 "
2 "	5 "	2 "
1 "	6 "	2 "
2 "	9a	1 "
1 "	10	1 "
1 "	11	37
2 "	12	5 "
2 "	12a	4 "
1 "	16	1 "
1 "	16d	4 "
1 "	19c	2 "
		23a
		24
		26
		27a
		32
		37
		37a
		41
		45
		48
		59
		77
		111
		111c
		117
		137
		145
		147b
		1 Electric Motor (100-250 volt)

Model No. 22 Desk Agenda

Two Meccano Wood Rollers 1 and 2 are mounted on 4 1/2" Axle Rods. The strip of paper passes over a sheet of cardboard bolted to two 5 1/2" x 3 1/2" Flat Plates, which, in turn, are placed on two 7 1/2" Angle Girders that are secured to the upper sides of the Sector Plates. When the exposed Strip of paper becomes filled with notes, it is only necessary to turn the rollers to bring another length of paper into position.

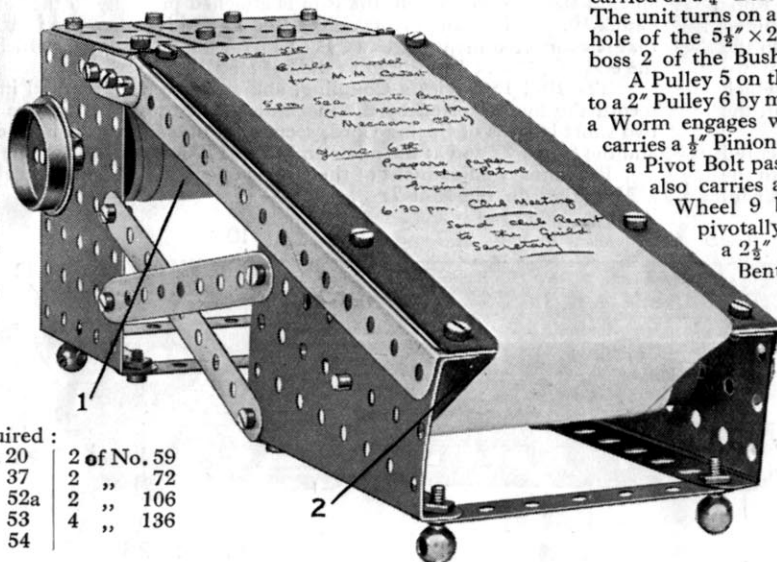

Parts required:

4 of No. 2a	2 of No. 20	2 of No. 59
4 "	3 "	2 "
2 "	6a	2 "
2 "	8b	2 "
2 "	15a	2 "
		32
		37
		52a
		53
		54

NEW MECCANO MODELS

Model No. 24 Rotary Truck Tipper

Parts required :

9 of No. 2a	4 of No. 11	4 of No. 26	2 of No. 63
6 " 3	8 " 12	4 " 27a	18" " 94
2 " 7a	4 " 12a	98 " 37	1 " 96
5 " 8a	2 " 12b	4 " 37a	3 " 96a
8 " 8b	4 " 15a	8 " 38	4 " 111a
4 " 9	5 " 16a	4 " 48d	4 " 120b
4 " 9d	4 " 18a	7 " 59	4 " 133
2 " 9f	4 " 23a	4 " 62	2 " 145

1 6-volt Electric Motor

The base is built up from five 9 1/2" Angle Girders 8 bolted to 18 1/2" Angle Girders 9. The "cage" is formed by two 5 1/2" Angle Girders 18 that, in turn, support four 7 1/2" Angle Girders 11. Two further 7 1/2" Angle Girders 14 bolted to the lower pair of transverse Angle Girders 18 form the rail track.

To the Girders 11 are bolted four 3 1/2" Strips 16 which support two more 7 1/2" Angle Girders 19, one on each side of the cage. These Girders support spring "pads" which grip the truck while the tipping operations are in progress. Two 5 1/2" x 1/2" Double Angle Strips 12 are connected together by bolts passed through their turned-up ends. These bolts also carry Angle Brackets 20 that are bent slightly so as to form guides for the entrance and egress of the truck. Two Cranks 13 bolted to the outer Double Angle Strip 12 carry 1 1/2" Rods. These Rods are journalled in Double Brackets bolted to the Angle Girder 19 and each carries a Compression Spring placed between the Double Brackets and the inner Double Angle Strip 12.

After passing the Rods through the Double Brackets a 3 1/2" Strip 12a is placed over their ends. A Bolt 15 passed through the Girder 19 is held loosely in position by a nut

and carries an Angle Bracket locked on the bolt by a second nut. A Collar is then secured to the bolt and carries a 1/2" Bolt 15a as shown. This completes the "gripping" device, and it will now be found that the Double Angle Strips 12 are forced by the Springs against the side of the truck. Using the Bolt 15a as a lever to turn the Bolt 15 the corner of the Angle Bracket may be brought into contact with the Strip 12a, thus drawing the "pad" 12 inwards and releasing the truck. The gripping device is duplicated on the other side of the cage.

The cage rests on four Pulleys that are mounted on Rods 5 (two 4 1/2" Rods coupled together) and journalled in 1" x 1" Angle Brackets bolted to the Angle Girders 8.

The Electric Motor is mounted on the base of the model, and a 1/2" Pinion 3 on the armature spindle engages a 57-teeth Gear, the spindle of which carries on the other side of the Motor a 3/4" Pinion engaging a further 57-teeth Gear. The Rod of this latter Gear carries a 1/2" Pinion meshing with another 57-teeth Gear 6, on the Rod of which is a further 1/2" Pinion 7 engaging a third 57-teeth Gear carried on a Rod journalled in the Motor framework. On this Rod is a 3/4" Sprocket connected by Sprocket Chain to a 1" Sprocket Wheel 4 on one of the Rods 5. The latter carries also a 3/4" Sprocket Wheel 4 connected by

Sprocket Chain to a 3/4" Sprocket Wheel on the other Rod 5. Rotation of the Motor therefore causes the Rods 5 with their Pulleys to revolve, and the Pulleys to impart rotary movement to the cage.

Model No. 25

Railway Island Platform

Parts required :

1 of No. 5
4 " 7a
2 " 9d
4 " 9f
2 " 16
54 " 37
4 " 52a
2 " 62b
4 " 70
2 " 103d
4 " 103h

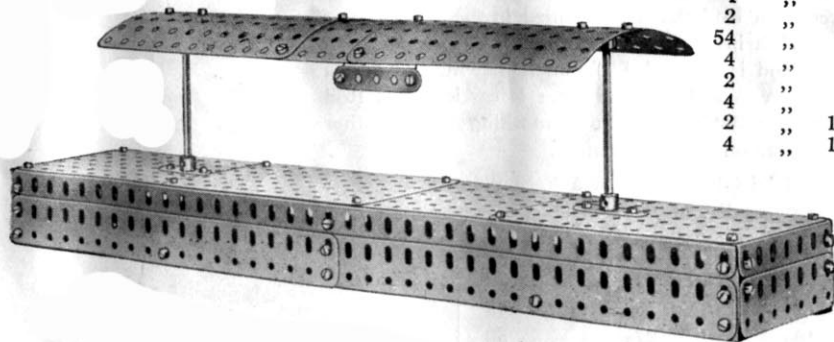

Model No. 26 Cattle Dock

Parts required :

2 of No. 8	2 of No. 48b
2 " 9b	4 " 52a
65 " 37	2 " 103b
1 " 37a	4 " 114

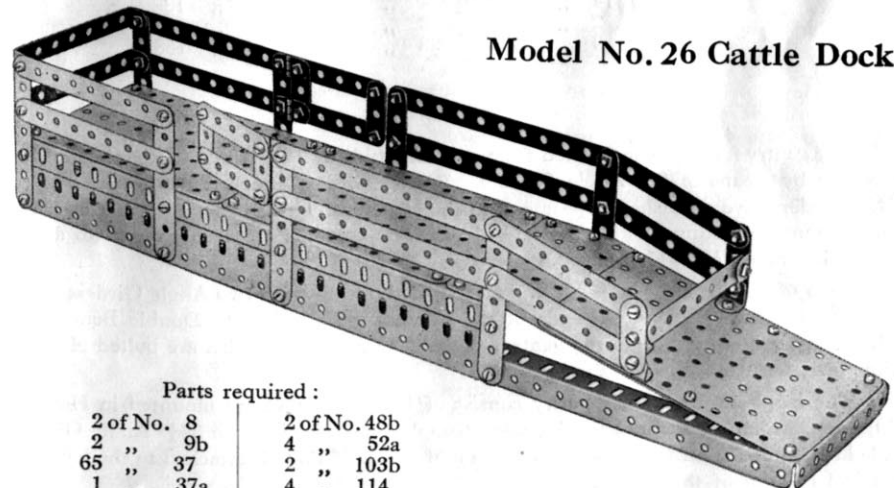

NEW MECCANO MODELS

Model No. 27 Railway Signal Gantry

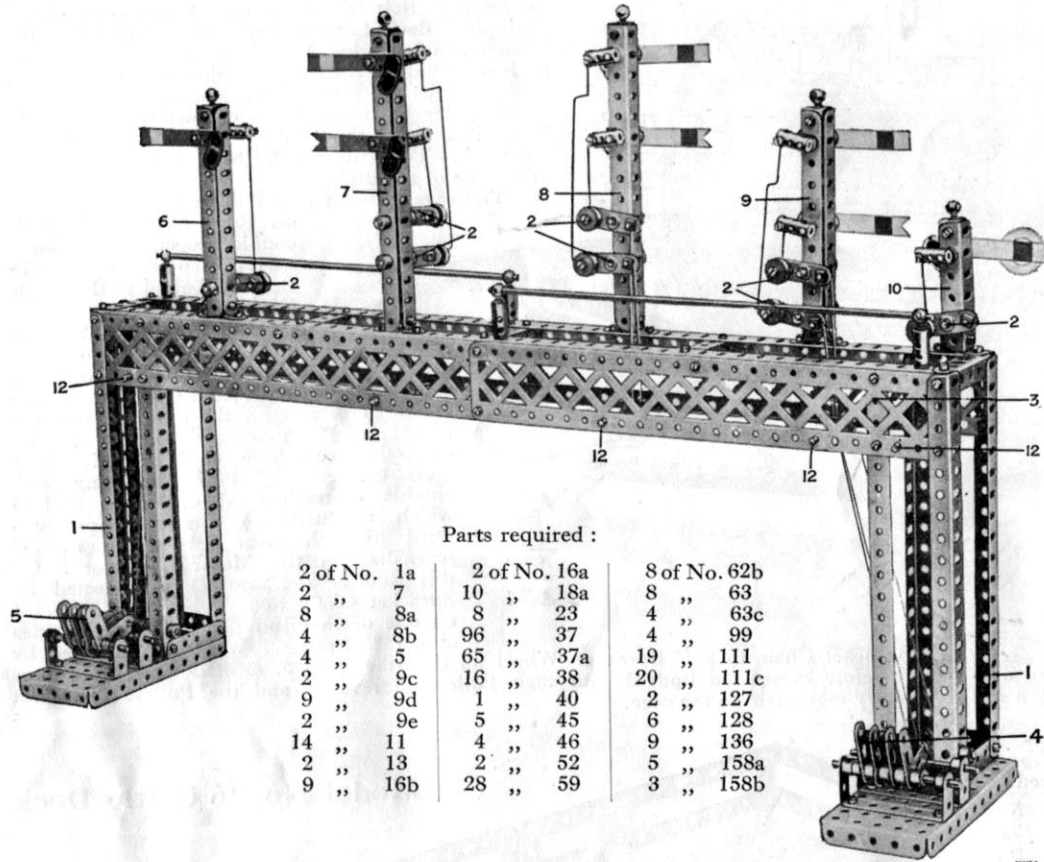

Parts required :

2 of No. 1a	2 of No. 16a	8 of No. 62b
2 " 7	10 " 18a	8 " 63
8 " 8a	8 " 23	4 " 63c
4 " 8b	96 " 37	4 " 99
4 " 5	65 " 37a	19 " 111
2 " 9c	16 " 38	20 " 111c
9 " 9d	1 " 40	2 " 127
2 " 9e	5 " 45	6 " 128
14 " 11	4 " 46	9 " 136
2 " 13	2 " 52	5 " 158a
9 " 16b	28 " 59	3 " 158b

The gantry frame is constructed from two longitudinal $2\frac{1}{2}$ " Angle Girders, connected together by means of $2\frac{1}{2}$ " Angle Girders. Braced Girders attached to the sides of the $2\frac{1}{2}$ " Girders give a finished appearance to the structure, which is supported at each end on columns consisting of $9\frac{1}{2}$ " Angle Girders. The columns are each secured to a base consisting of a $5\frac{1}{2}$ " x $2\frac{1}{2}$ " Flanged Plate.

Each of the signal posts (6, 7, 8, 9 and 10) is built up from two Angle Girders of the required length. The bottom ends of the Girders are attached to Double Bent Strips which, in turn, are bolted to the gantry. Double Brackets, to which are bolted Handrail Supports, form the tops of the posts.

The handrails round the gantry consist of $11\frac{1}{2}$ " Rods that are mounted in Handrail Supports, which are secured to Threaded Couplings attached to the $2\frac{1}{2}$ " Angle Girders. A ladder formed from two $9\frac{1}{2}$ " Strips and a number of $\frac{3}{4}$ " Bolts is attached to the left hand vertical column of the model.

Each of the signal arms is secured on a 1" Rod that is journalled in holes in its respective post. On the opposite ends to the arms these Rods carry Couplings to form cranks that are connected by wire to one arm of the Double Arm Cranks 2. (The Control wire contained in the Hornby Control Outfit is excellent for purposes of connection). The Double Arm Cranks are pivoted on 1" Rods that also are journalled in holes in the signal posts, and they carry in their end holes $\frac{1}{2}$ " loose Pulleys that are secured by $\frac{1}{2}$ " Bolts. These Pulleys represent the balance weights of an actual signal, which are used to return the signal to the danger position. The other arms of the Cranks are connected by wire with the control levers in the lever frames 4 and 5, one lever being connected to each signal. The cords are led over 3" Rods 12 to the points required.

The signal control levers are formed by Boss Bell Cranks, which are mounted on 3" Rods journalled in $2\frac{1}{2}$ " x 1" Double Angle Strips that are bolted to the base plates of the model. The method of arranging the control wires to the various signals is quite clear in the illustration. A 3" Rod mounted horizontally behind the control levers keeps the latter in uniform position when the signals are at danger.

Model No. 28 Map Measuring Instrument

Many of our cyclist readers must have felt the want of a simple means whereby they may ascertain distance correctly on a map. In this model, it is only necessary to roll a wheel along the route desired in the map to obtain a very close approximation of the actual distance.

The instrument dial is divided into forty equal parts representing inches, which when compared with the scale of the map will give the mileage. Thus, if the dial gives a reading of 10, and the scale of the map is $\frac{1}{2}$ " to the mile, the actual distance will be 20 miles.

The instrument consists essentially of a Bush Wheel 1 secured to a Rod that is journalled in the end holes of the two $5\frac{1}{2}$ " Strips forming the frame of the model. On the same Rod is secured a $\frac{1}{2}$ " Pinion that meshes with a 57-teeth Gear Wheel 2. The latter is carried on a Rod on which is a further $\frac{1}{2}$ " Pinion meshing with another 57-teeth Gear on the dial shaft 3.

The dial itself consists of a Face Plate on which is stuck a circular disc of white cardboard.

Parts required :

2 of No. 2	2 No. of 24	5 of No. 37	1 No. of 62b
3 " 17	2 " 26	1 " 48	1 " 109
1 " 18a	2 " 27a	4 " 59	1 " 125

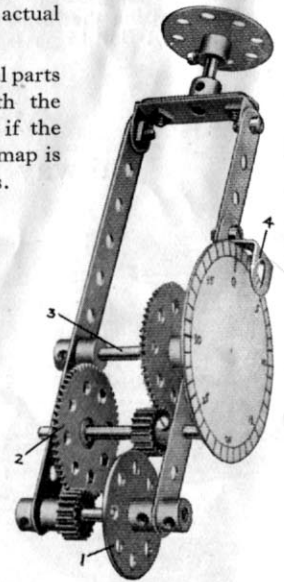

Model No. 29 Naval 6" Gun

This Meccano model represents a small but formidable type of weapon to be found on most ships of war. It is of realistic appearance, and one of its most attractive features is the fact that it will actually fire "shells"—in the form of Washers—quite a respectable distance.

The "barrel" of the gun is composed of a 12½" Angle Girder 1 and a 9½" Angle Girder 2 arranged to form a "square tube." A 4½" Flat Girder is bolted to one end of the 12½" Girder and a 1½" Flat Girder is secured to the corresponding end of the 9½" Angle Girder. Two 4½" Angle Girders—bolted together to form a channel-section girder—are next secured to the top edges of the 4½" and 1½" Flat Girders, and on the same side of the barrel as the 1½" Flat Girder a 2" Flat Girder is attached to the 4½" Angle Girder.

The gun is "trained" by means of the 1" fast Pulley 6a mounted at the top end of a Rod carrying the 1" Pulley 6, which is shod with a small Rubber Ring (part No. 155). The Rubber Ring is arranged to press on the periphery of the Circular Plate, so that by turning the Pulley 6 the entire gun is moved about the central pivot 5. Two 3½" Rods—representing the telescopic sights—are mounted in new style Collars that are secured to Angle Brackets bolted to the top ends of the Cranks 3. The barrel of the gun is elevated or depressed by means of the simple mechanism that is controlled from the Pulley 4.

The firing mechanism is arranged as follows. An 11½" Rod 8 is placed inside the barrel and attached to the rear end by means of a Coupling. This Coupling is secured to the 2" and 4½" Flat Girders by bolts that are passed through the holes of the Flat Girders and inserted in the tapped holes of the Coupling, and the latter is spaced from the Flat Girders by two Washers on each retaining bolt. The loading mechanism consists of a Bolt 10 locked by a nut in the tapped hole of a Collar, which is secured to a Rod that is free to turn and slide in its bearings (formed by two Handrail Supports). The Rod is fitted with a handle 11.

The trigger mechanism is assembled as follows. A Hinge secured by the Bolt 15 to the front hole of the 2" Flat Girder has a Flat Bracket secured to it by the slotted hole, two Washers

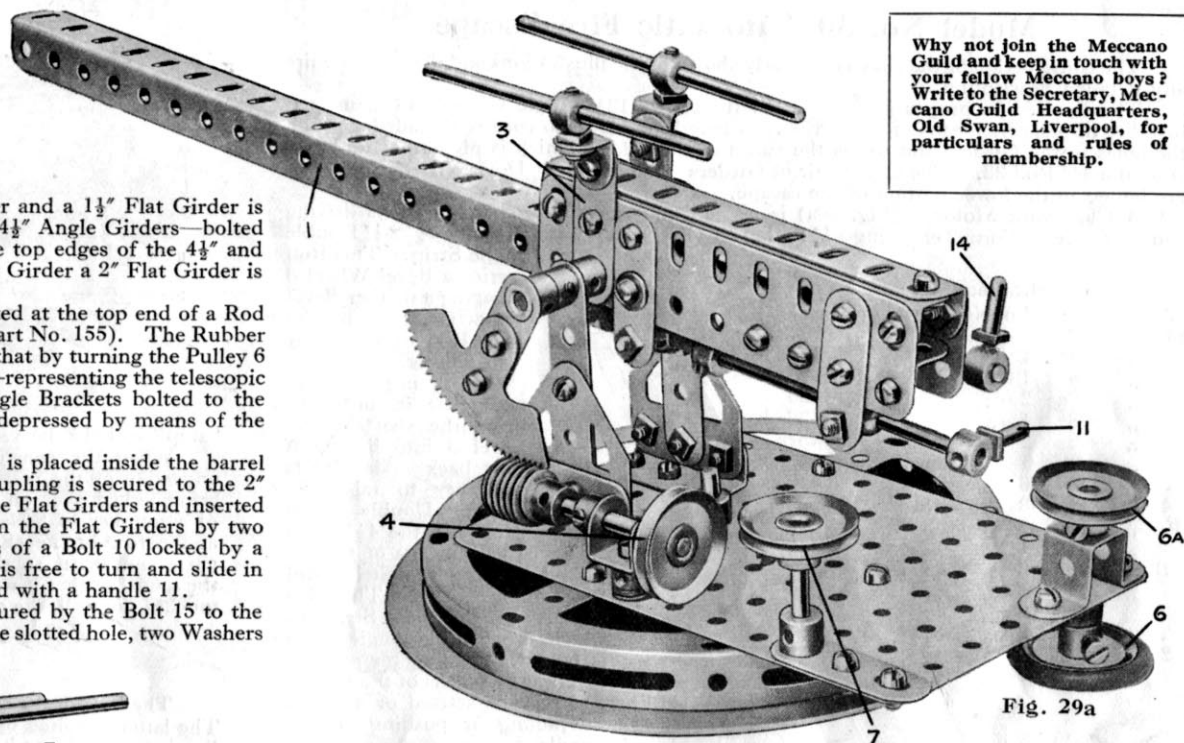

Why not join the Meccano Guild and keep in touch with your fellow Meccano boys? Write to the Secretary, Meccano Guild Headquarters, Old Swan, Liverpool, for particulars and rules of membership.

Fig. 29a

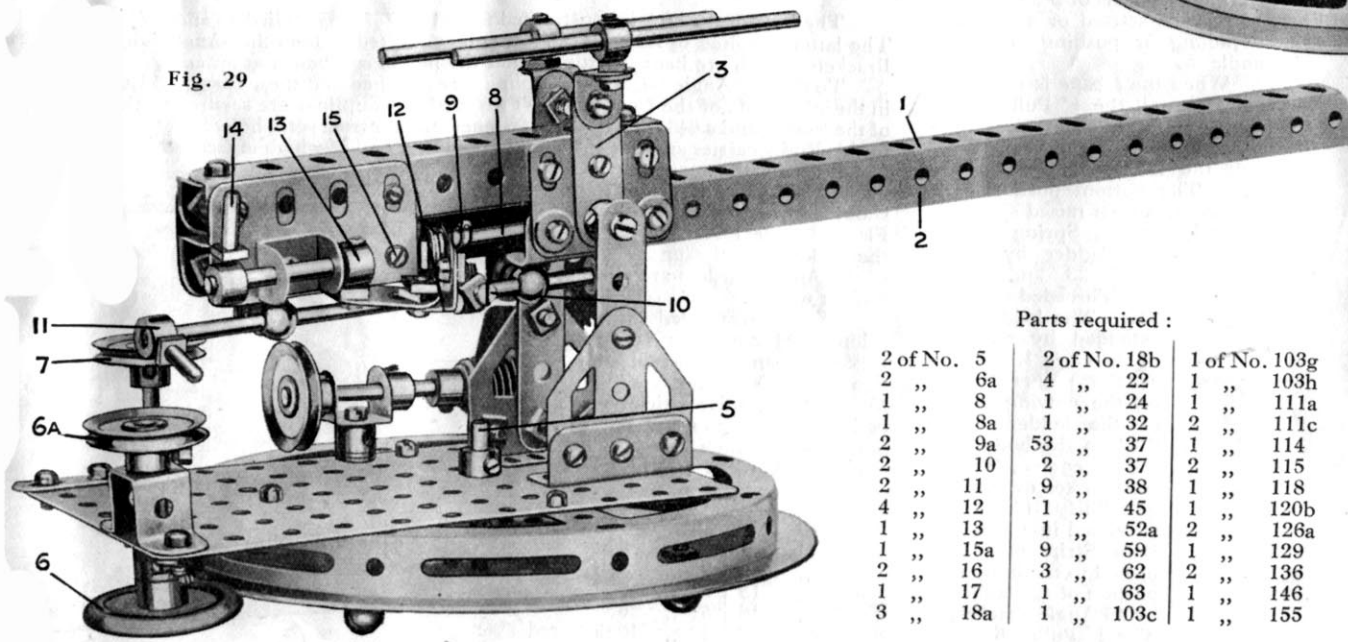

Fig. 29

being placed on the retaining bolt between the Flat Bracket and the Hinge. A ½" x ½" Angle Bracket 12 is secured in the round hole of the Flat Bracket, and is connected pivotally by means of a second Flat Bracket to the Collar 13. This Collar is secured to a short Rod carrying the handle 14, by means of which the Rod may be moved to and fro in the Double Bracket forming its bearings.

To load the gun, the Washer forming the projectile is placed on the front end of the 11½" Rod 8 and the barrel of the gun tilted up to allow it to slide down the Rod to the Compression Springs 9. Next the handle 11 is pushed away from the operator, turned so that the head of the bolt 10 engages with the Washer, and then pulled back—or toward the operator—so that the Washer compresses the Spring 9. Previous to this, however, the handle 14 controlling the trigger should be pulled toward the operator. The handle may now be pushed outward so that the Flat Bracket engages with the Washer. The gun is now ready for firing.

Parts required :

2 of No. 5	2 of No. 18b	1 of No. 103g
2 " 6a	4 " 22	1 " 103h
1 " 8	1 " 24	1 " 111a
1 " 8a	1 " 32	2 " 111c
2 " 9a	53 " 37	1 " 114
2 " 10	2 " 37	2 " 115
2 " 11	9 " 38	1 " 118
4 " 12	1 " 45	1 " 120b
1 " 13	1 " 52a	2 " 126a
1 " 15a	9 " 59	1 " 129
2 " 16	3 " 62	2 " 136
1 " 17	1 " 63	1 " 146
3 " 18a	1 " 103c	1 " 155

Model No. 30 Automatic Fire Escape

The construction of the chassis is clearly shown in the illustrations and does not require any detailed description.

The fire escape proper is constructed from four $12\frac{1}{2}$ " Angle Girders 13 connected together in pairs by means of $2\frac{1}{2}$ " Strips. A length of Meccano cord is threaded through the holes in the Girders and forms the rungs of the ladder, which is pivoted at its lower end on a $4\frac{1}{2}$ " Rod 22. The upper pair of Girders 13 slide in four Double Brackets 16 that are bolted to the lower portion of the escape.

A Clockwork Motor 1 (Fig. 30a) is carried underneath the chassis and its driving spindle carries a Worm 2 engaging a $\frac{1}{2}$ " Pinion on a Rod that is journalled in a $2\frac{1}{2}$ " \times $\frac{1}{2}$ " Double

Parts required :		
2 of No. 2	1 of No. 18b	1 of No. 81
4 " 2a	4 " 19a	1 " 102
4 " 3	1 " 22	5 " 111c
7 " 5	1 " 23a	1 " 116
10 " 6a	2 " 23	2 " 126
6 " 8	1 " 26	4 " 126a
2 " 9	2 " 30	1 Clockwork
2 " 9b	1 " 32	Motor
2 " 10	86 " 37	
4 " 11	8 " 37a	
10 " 12	2 " 38	
4 " 12a	1 " 40	
1 " 13	2 " 43	
1 " 14	1 " 48a	
3 " 15	2 " 48b	
2 " 16	2 " 52a	
2 " 16a	20 " 59	
1 " 18a	1 " 62	

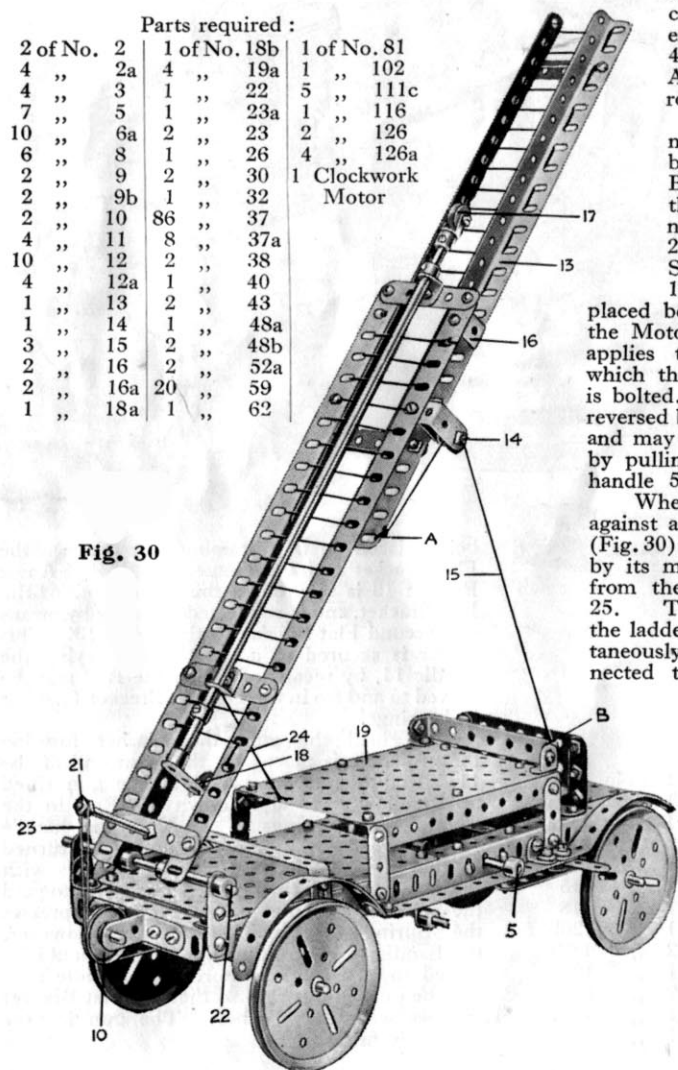

Fig. 30

Angle Strip. This Rod carries a Bevel Wheel 3 engaging a further Bevel 4 that is carried on the Axle Rod of the front road wheels.

It is important to note that in order to bring the shaft of the Bevel 3 into line with the back axle it is necessary to raise the $2\frac{1}{2}$ " \times $\frac{1}{2}$ " Double Angle Strip and the $4\frac{1}{2}$ " Strip 12 by means of Collars

placed between the Strips and the Motor casing. This also applies to the $3\frac{1}{2}$ " Strip to which the Double Angle Strip is bolted. The Motor may be reversed by means of the lever 7 and may be started or stopped by pulling or pushing on the handle 5.

When the escape is run up against a wall the $\frac{1}{2}$ " Pulley 17 (Fig. 30) is forced back, releasing by its movement the catch 18 from the Double Angle Strip 25. The bottom portion of the ladder is then raised simultaneously by the Spring connected to the ladder by the Cord 23 and the 2" Threaded Rod 21. The ladder is extended by means of the Cord 15 fixed at the points "A" on the moving part of the ladder and "B" on the body of the fire engine. This cord passes over the $\frac{1}{2}$ " Pulley 14 that is carried in a Single Bent Strip and attached to the bottom portion of the ladder by an Angle Bracket. The $\frac{1}{2}$ " Pulley 6 is a

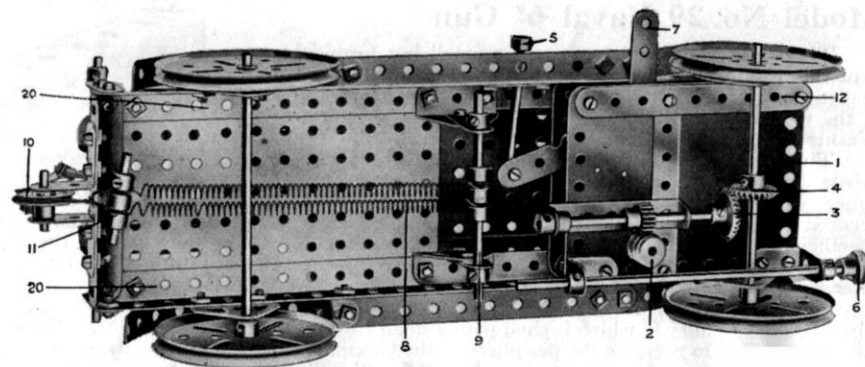

Fig. 30a

"stop" to hold the vehicle from the wall while the ladder is rising.

When the construction is completed it is a good plan to attach a weight to the underside of the rear portion of the model. The idea of this is to prevent the model being jerked over on the sudden release of the escape. The weight may be composed of a number of Strips bolted face to face, the whole being secured to a suitable point at the rear of the chassis. Before setting the model in motion apply a little oil to the gears and shafts so that everything will run smoothly. Then wind the Motor and place the model so that it will run up to the wall of the room, where, as soon as the Pulley, 17 touches the wall, the escape will be released.

Model No. 31 Pen Rack

The base of the rack is constructed from two $7\frac{1}{2}$ " Angle Girders and a $7\frac{1}{2}$ " Flat Girder. The latter is bolted to Angle Girder 1, and connected to the other Angle Girder 2 by Flat Brackets, which are bent slightly so that the model can be set at an angle.

To the $7\frac{1}{2}$ " Angle Girder 2 Couplings are attached and these carry $4\frac{1}{2}$ " Rods 3 inserted in the other ends of the Couplings. Two further Couplings are secured to the upper ends of the Rods 3 and a $6\frac{1}{2}$ " Axle Rod 4 is fastened in their transverse holes. A Coupling secured to this Rod 4 carries another $4\frac{1}{2}$ " Rod, to the lower end of which is secured a Flanged Wheel, which forms the rear support.

The angle of the latter Rod should be adjusted until the Flanged Wheel rests firmly on the table when the under sides of the Angle Girders are also in contact with it.

When constructed in the coloured Meccano parts the pen rack forms an ornamental addition for the Meccano boy's den. Many other similar articles may be built in Meccano and put to practical use—such as magazine stands, book racks and blotters, etc.

Parts required :		
2 of No. 8b	6 of No. 37	
2 " 12	2 " 37b	
1 " 15	8 " 62	
3 " 16	5 " 63	
1 " 20	1 " 103k	

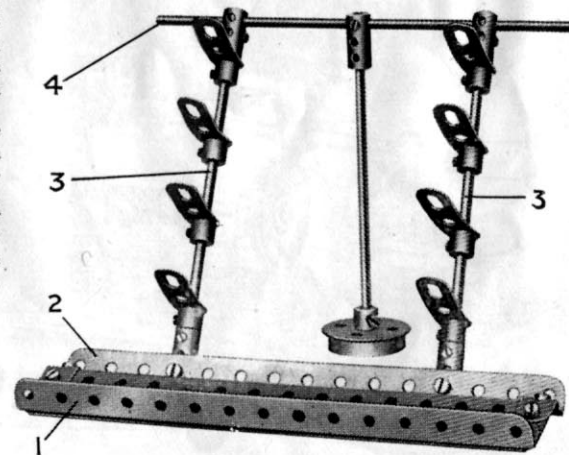

The weighing mechanism is arranged as follows:—The platform carries rails 19 (Fig. 32) on which the truck to be weighed is placed. On the underside of the platform is bolted a 2½" × 1" Double Angle Strip 16 (Fig. 32a), which carries a 3½" Rod 15, and two 1" × 1" Angle Brackets, carrying Threaded Pins 18. When the platform is placed in position the Rod 15 (Fig. 32a) bears against two 5½" Strips 2 (Fig. 32b) that are supported pivotally at the front end by Flat Brackets mounted between Collars on the Rod 1. At the rear the Strips 2 are spaced apart by two ½" Reversed Angle Brackets 7 which are bolted to a Flat Bracket 7a.

A length of Meccano Sprocket Chain 8 connects the Flat Bracket 7a with the horizontal 3½" Threaded Rod 9, this latter being passed through the centre transverse hole of a Coupling 11. Rod 9 carries at one end a Coupling in the lower transverse hole of which a 4½" Rod is secured. A weight 12 (a worm wheel) is free to slide on this Rod and another weight 10, formed by

two Flanged Wheels, is secured to a Coupling that may be fixed at any suitable point on the other end of the balance arm. The entire arm of the balance is suspended from the Coupling 13 by means of a piece of strong silk 14.

Two 2½" Strips 6a are held loosely between Collars on the Rod 6 and their other ends serve to hold a Rod 5 that passes under the Strips 2. A Double Bracket 4 is passed over the Rods 3 and 5 and held in place by a ¾" Bolt 4a. The platform merely rests on the levers in the base, the Rod 15 and Threaded Pins 18 (Fig. 32a) making contact with the Strips 2 and 6a respectively. The Angle Brackets 17 are merely guides and rest against the inner sides of the Braced Girders in the base.

The position of the weight 10 should be adjusted so that the balance arm is horizontal when no load is applied to the platform. A truck placed on the rails 19 causes the arm 9 to be pulled downwards by the Chain 8, and the extent of the load may be calculated by noting the distance through which it is necessary to move weight 12 in order to return the arm to the horizontal.

Weighing operations will, of course, be facilitated if a graduated scale is attached to the horizontal arm 20. The graduations can be ascertained in the first place by placing objects of known weight on the platform and noting the

Model No. 32 Truck Weighing Machine

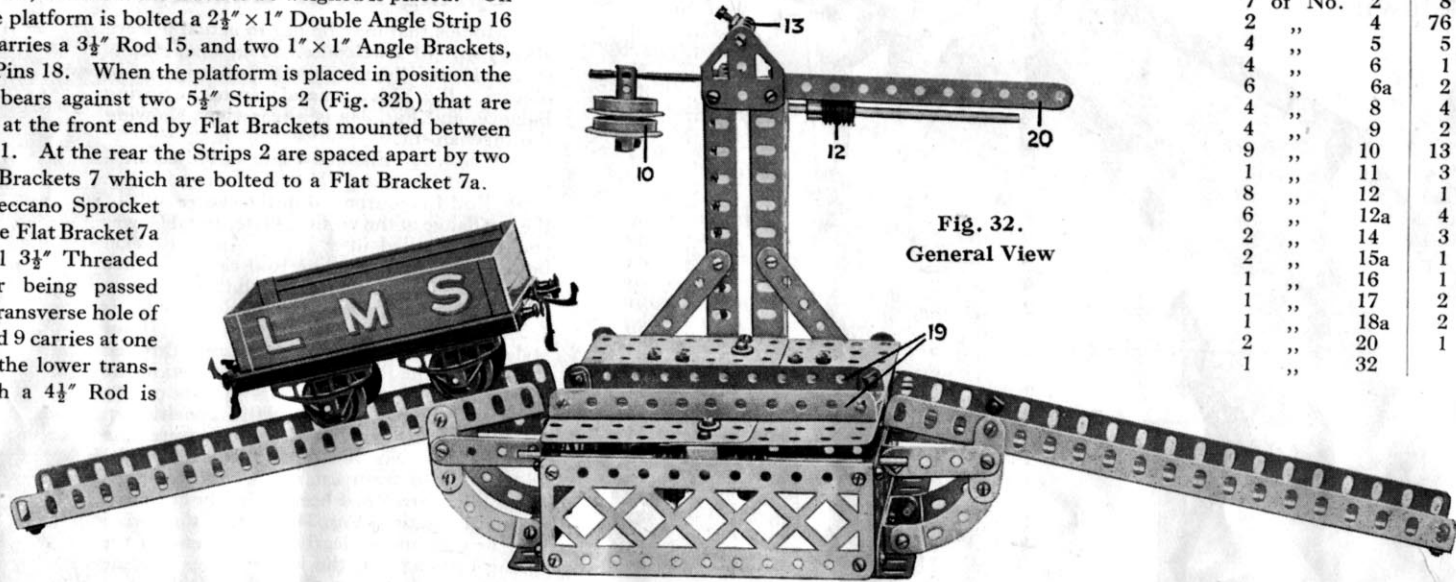

Fig. 32. General View

Parts required :

7	of	No. 2	8	of	No. 35
2	"	4	76	"	37
4	"	5	5	"	37a
4	"	6	1	"	46
6	"	6a	2	"	48
4	"	8	4	"	48d
4	"	9	2	"	52a
9	"	10	13	"	59
1	"	11	3	"	63
8	"	12	1	"	80a
6	"	12a	4	"	90a
2	"	14	3	"	100
2	"	15a	1	"	111
1	"	16	1	"	111c
1	"	17	2	"	115
2	"	18a	2	"	125
1	"	20	1	"	126a
1	"	32			

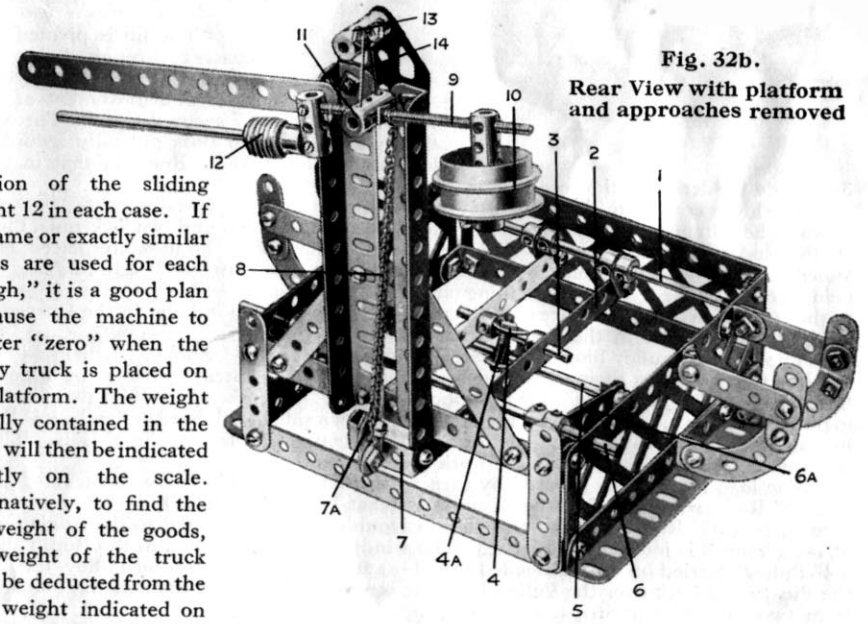

Fig. 32b. Rear View with platform and approaches removed

position of the sliding weight 12 in each case. If the same or exactly similar trucks are used for each "weigh," it is a good plan to cause the machine to register "zero" when the empty truck is placed on the platform. The weight actually contained in the truck will then be indicated directly on the scale. Alternatively, to find the net weight of the goods, the weight of the truck must be deducted from the total weight indicated on the scale.

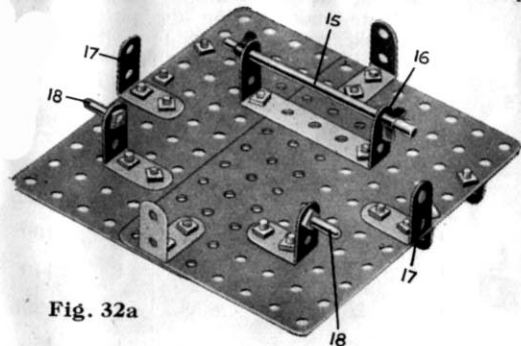
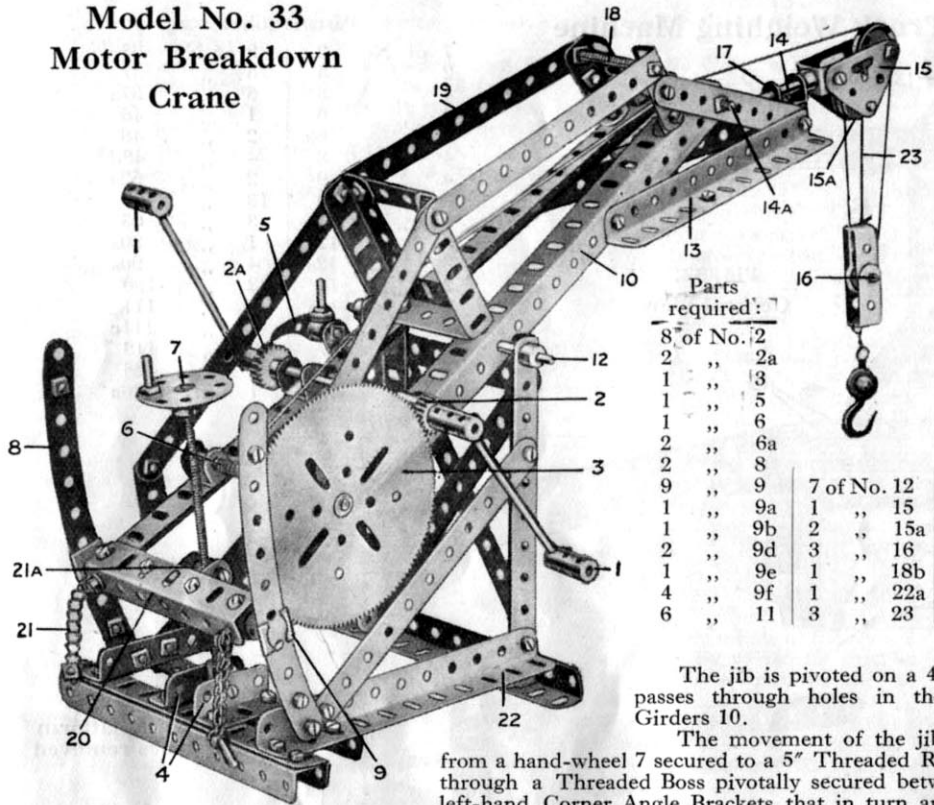

Fig. 32a

Model No. 33
Motor Breakdown
Crane



Parts required:

8 of No. 12	7 of No. 12
2 " 2a	1 " 15
1 " 3	2 " 15a
1 " 5	3 " 16
1 " 6	1 " 18b
2 " 6a	1 " 22a
2 " 8	3 " 23
9 " 9	
1 " 9a	
1 " 9b	
2 " 9d	
1 " 9e	
4 " 9f	
6 " 11	

1 of No. 24	1 " 26
1 " 27b	60 " 37
11 " 37a	5 " 38
1 " 40	1 " 44
1 " 44	2 " 50a
1 " 57b	13 " 59
4 " 63	1 " 64
1 " 80b	2 " 81
2 " 89	4 " 94
2 " 102	1 " 111
2 " 111a	2 " 111c
4 " 115	1 " 116
1 " 116	2 " 133
1 " 147a	1 " 147b
1 " 148	

The jib is pivoted on a $4\frac{1}{2}$ " Rod 12 that passes through holes in the $12\frac{1}{2}$ " Angle Girders 10.

The movement of the jib is controlled from a hand-wheel 7 secured to a 5" Threaded Rod that passes through a Threaded Boss pivotally secured between right and left-hand Corner Angle Brackets that in turn are bolted to a

$3\frac{1}{2}$ " Angle Girder 20 at the rear end of the jib.

The lower end of the Threaded Rod passes through a Collar pivotally secured between $1\frac{1}{2}$ " Angle Girders 4, and is held in position in the Collar by means of another Collar and two lock-nuts, the former being placed on the Rod against the upper face of the pivoted Collar while the nuts are placed against the lower face. When the hand-wheel 7 is turned the Threaded Boss is caused to rise or fall, carrying the jib with it, the jib being guided by the Eye Pieces 9 sliding on the Curved Strips 8. Short lengths of Sprocket Chain 21 secured to the rear of the jib carry Threaded Pins which may be placed in holes in the Curved Strips 8 and used to hold the jib securely in the required position.

The hoisting pulley block 15 is carried on the end of a $5\frac{1}{2}$ " Rod 14 journalled in a Double Bracket 17 and in a Cranked Bent Strip, the latter being secured to a $2\frac{1}{2}$ " Strip bolted to the underside of the $5\frac{1}{2}$ " Angle Girders 13. The jib head Pulley is supported on a $\frac{3}{4}$ " Bolt passed through two Corner Brackets and held in position by a nut. Collars are placed on the bolt each side the jib head pulley. A $\frac{1}{2}$ " Pulley 15a is journalled in a similar manner to the 1" Pulley, but a 1" Rod is used in place of the $\frac{3}{4}$ " Bolt. The whole pulley block is attached to the Rod 14 by a large Fork Piece.

The load is raised or lowered by turning the handles 1, which are constructed as shown and secured to a $5\frac{1}{2}$ " Rod carrying a $\frac{1}{2}$ " Pinion 2 and a Ratchet Wheel 2a. The Pinion 2 engages a $3\frac{1}{2}$ " Gear Wheel 3 secured to a $3\frac{1}{2}$ " Rod 6 that is journalled in Double Brackets secured to the Angle Girders 10. The Rod of the Pinion 2 is journalled likewise. The winding cord is attached to the Rod 6 and passes thence over a $\frac{1}{2}$ " Pulley (carried on a 2" Threaded Rod 14a) and over the 1" jib head Pulley, then round a $\frac{1}{2}$ " Pulley on the Pin 16 and back over the Pulley 15a. It is attached finally to the hoisting block, which is constructed from two Single Bent Strips.

A Pawl is pivoted in a Double Bracket bolted to one of the Girders 10 and serves to hold the load suspended by preventing the winding Rod revolving when the handles 1 are released.

Model No. 34
Spring Letter Balance

Models that may be put to actual use are always sure of a welcome. This one, if constructed carefully, may be used to weigh small objects. Fig. 34 is a general view of the Spring Balance, and Fig. 34a is a rear view, showing the mechanism.

A $5\frac{1}{2} \times 2\frac{1}{2}$ " Flanged Plate is bolted in a vertical position to a $3\frac{1}{2} \times 2\frac{1}{2}$ " Flanged Plate. A $6\frac{1}{2}$ " Rod 1 is journalled in the centre hole of the top flange of the vertical Plate, and its lower end is journalled in a $\frac{1}{2} \times \frac{1}{2}$ " Angle Bracket bolted to the Plate. The Rod carries a Face Plate on its upper end, on which the objects to be weighed are placed, and a Rack Strip is secured to it by means of two Collars (new style), ordinary bolts being passed through the holes in the Rack Strip and inserted in the set-screw holes of the Collars. Nuts on the bolts hold the Rack Strip rigidly in position.

The spring consists of three Compression Springs (Part No. 120b) placed on the Rod 1 and separated from each other by Washers. (The Rack Strip has been partially cut away in the illustration, Fig. 34a, so that the spring may be seen more clearly). The end of the spring rests against the lower Collar holding the Rack Strip to the Rod 1.

A $2\frac{1}{2} \times \frac{1}{4}$ " Double Angle Strip is bolted between the flanges of the upright $5\frac{1}{2} \times 2\frac{1}{2}$ " Flanged Plate in such a position that it prevents the Rack Strip twisting round and so becoming disengaged with the $\frac{1}{2}$ " Pinion on the Rod 2. The latter Rod is journalled in a reinforced bearing consisting of a Double-arm Crank bolted to the Flanged Plate. It carries a Pointer (Fig. 34) at its outer end.

The scale is cut from a piece of cardboard. It may be calibrated by placing weights of different known values on the Face Plate and marking the position the Pointer takes up on the scale for each weight. Care should be taken to see that the Pointer is exactly at zero when no weight is on the Face Plate.

Parts required:

1 of No. 14	3 of No. 38	1 of No. 62b
1 " 18a	1 " 48a	1 " 109
1 " 12	1 " 52	1 " 110
1 " 26	1 " 53	3 " 120b
8 " 37	3 " 59	1 " 156

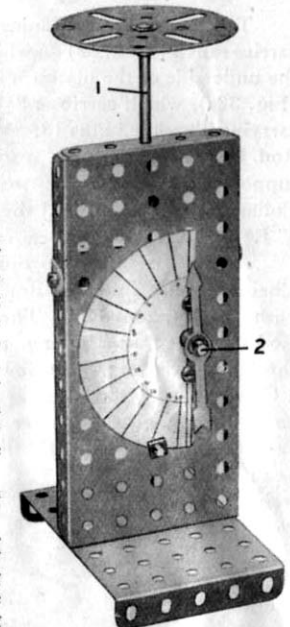

Fig. 34

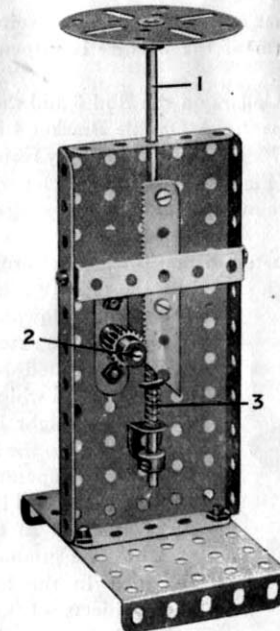
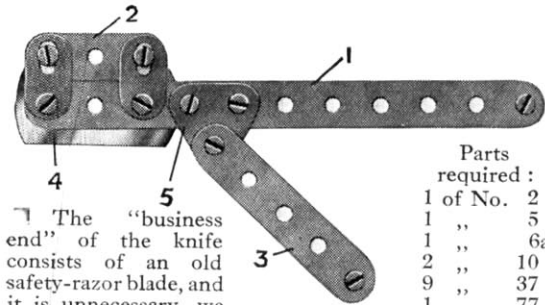

Fig. 34a

Model No. 35 Meccano Penknife



The "business end" of the knife consists of an old safety-razor blade, and it is unnecessary, we hope, to warn our readers that this should be handled carefully during construction! The blade is bolted between two 5 1/2" Strips 1 and two 1 1/2" Strips 2 connected at either side by two Flat Brackets. A safety cover 3 constructed from two 2 1/2" Strips spaced apart by a Washer, pivots about a bolt mounted in 1" Triangular Plates 5, and fitting over the protruding portion of the blade 4, safeguards one against accidental cuts.

Photographers will find this knife very useful in trimming their prints, etc. Indeed, there must be many purposes for which it will be found specially suitable, although Meccano boys should not attempt to shave with it!

Parts required :	
1 of No.	2
1 "	5
1 "	6a
2 "	10
9 "	37
1 "	77

Model No. 36 Match Box Holder

The match-box holder is designed to take the standard size match-box and consists of two 2 1/2" x 2 1/2" Flat Plates joined by Double Brackets and a Fork Piece 1.

The stand is built up from a 3 1/2" Axle Rod secured to a 3" Pulley Wheel forming the base. Couplings and a Worm Wheel are fastened to the 3 1/2" Rod to increase the weight of the stand and a Bush Wheel 2 mounted in the position shown carries the Wheel Flange 3, which forms the ash-tray.

If desired a strip of sand paper or the roughened portion of a match-box cover may be pasted on each of the Flat Plates to facilitate the striking of the matches.

Parts required :	
2 of No. 11	2 of No. 63
1 " 19b	2 " 72
1 " 24	1 " 116
1 " 32	1 " 137
10 "	37

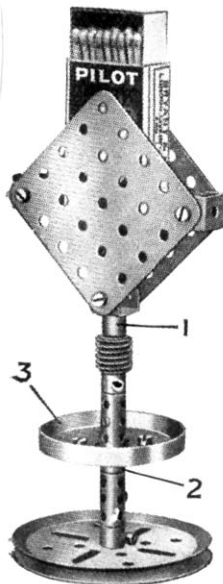

Model No. 37 Eccentric Driver

The Eccentric Driver is a very amusing mechanical toy that will afford much laughter to the builder and his friends. It will be readily seen from the illustration that the model is of quite simple character and will not offer any great difficulty in construction.

When the Clockwork Motor is wound and the model placed on the floor, it dashes first in one direction and then, without any warning, turns off at a tangent and runs in a totally different direction. It will continue these wild capers until the motor requires rewinding.

It is possible to make the figures of the driver and his passenger exceedingly life-like, and if the arms of the passenger are arranged so that he appears to be holding on to his seat very tightly, the effect will be still more amusing.

The Strips forming the body and legs of the "driver" are bolted to a Fork Piece that is secured to a short Rod which, in turn, is secured in the boss of a Bush Wheel. This Bush Wheel is connected to the Motor by means of two 3 1/2" Angle Girders bolted together as shown.

The Motor actuates the rear wheels through a Bevel Wheel 6 secured to the driving spindle of the Motor and engaging the Bevel 7 on the Rod 8 (Fig. 37a). This Rod also carries a 3/8" Pinion engaging a 50-teeth Gear Wheel 9 secured to the axle of the rear wheels.

The steering column 4 carries at its lower end a Bush Wheel 10 to which is secured a 1 1/2" x 1/2" Double Angle Strip that forms a support for the 2 1/2" front axle. The steering is controlled as follows:—Two 1 1/2" Strips 11 are bolted together by three bolts, and two Washers are placed on each bolt between the Strips for spacing purposes.

The link thus formed fits over the Motor key shaft, and when the Motor is set in motion the link will be rotated slowly with the keyshaft. One end of the link carries a Collar 13 which is held on one of the end securing bolts of the link in place of a nut. A 3" Strip 12 is pivoted on a bolt that is secured in one of the tapped holes in the Collar 13 and its other end is attached pivotally to the end of a Crank 14 that is secured to the steering column.

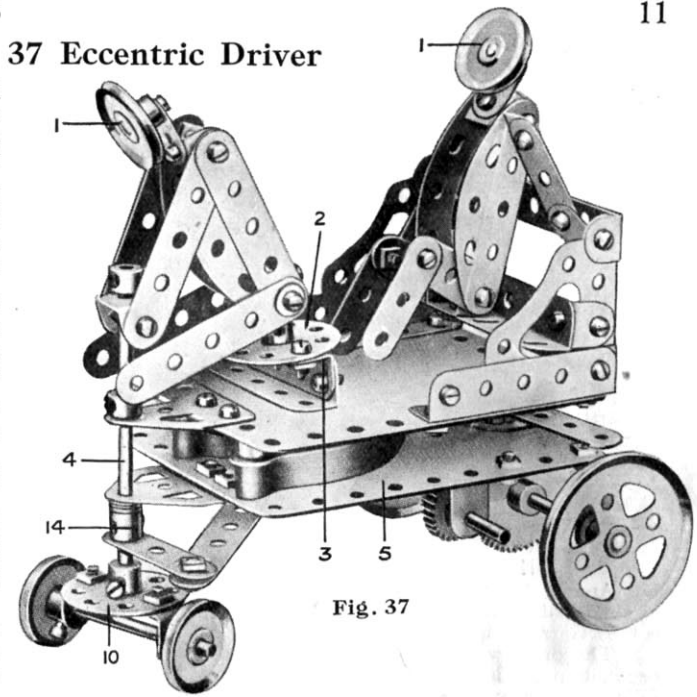

Fig. 37

Hence, when the Motor is started, the link 11 rotates slowly and imparts motion to the Strip 12 which, in turn, influences the steering column, resulting in the front wheels being turned first to the right and then to the left alternately, so causing the model to perform some very amusing antics.

Parts required :			
1 of No. 4	4 of No. 12a	3 of No. 24	1 of No. 48
8 " 5	1 " 15a	1 " 25	3 " 48b
7 " 6a	2 " 16	1 " 27	3 " 59
1 " 9b	1 " 16a	2 " 30	1 " 62
4 " 9d	1 " 18b	44 " 37	4 " 90a
3 " 10	2 " 20a	4 " 37a	2 " 108
4 " 11	4 " 22	13 " 38	6 " 111c
1 " 12			2 " 126a

1 Clockwork Motor.

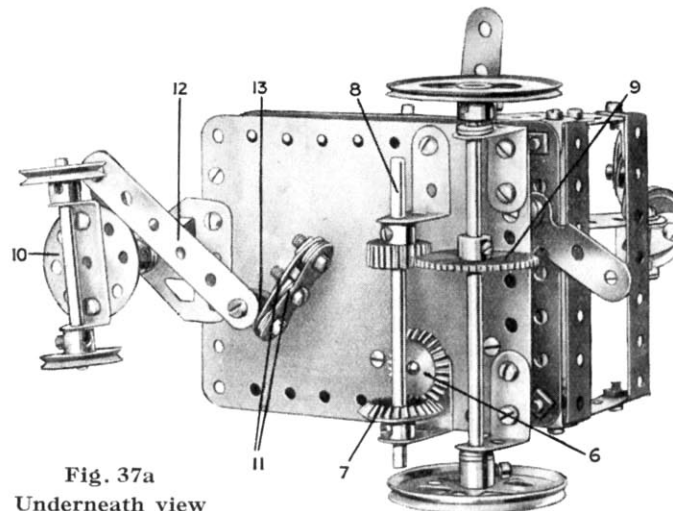
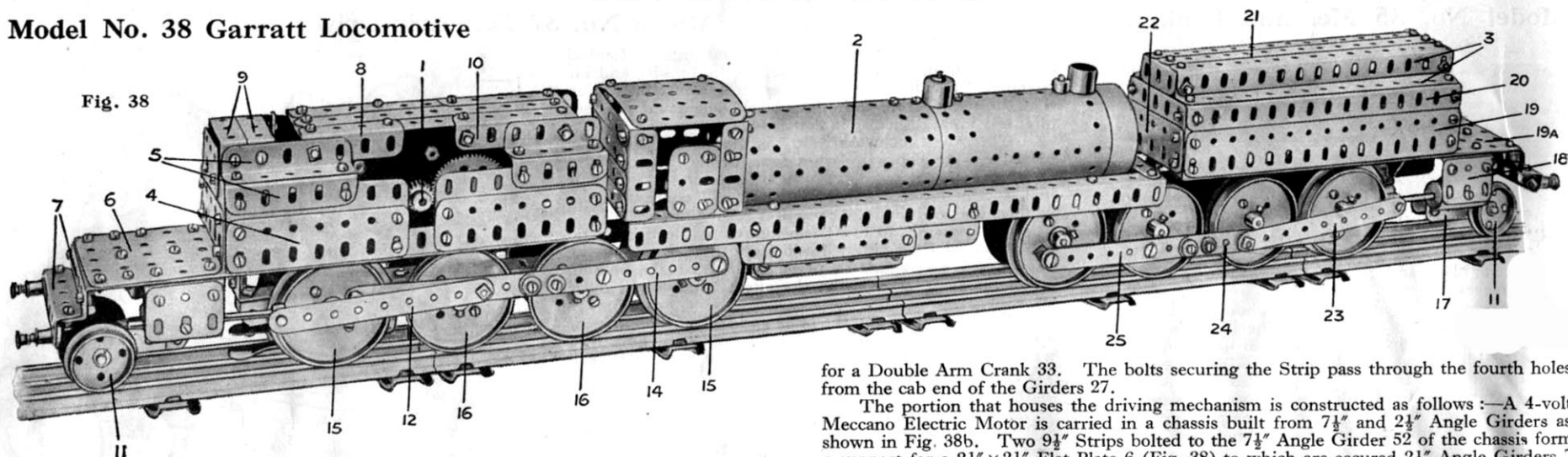

Fig. 37a
Underneath view

The "Meccano Magazine" contains all-important news for Meccano boys, such as particulars of new parts, descriptions of new models, and criticisms of entries in the Model-building Competitions, as well as announcements of new contests. The "M.M." appears on the first of every month (see page 4 of cover of this Book).

Model No. 38 Garratt Locomotive



Among the many special types of locomotives developed in recent years to meet unusual or abnormal requirements, one of the most important and at the same time most interesting is the "Garratt" articulated type.

The primary purpose of articulated locos in general is to provide for safe and easy negotiation of difficult curves. The "Garratt" loco possesses this valuable feature to the full, and moreover, it provides a range of power that cannot be attained with locos of the conventional type running under similar conditions. Another point of importance is that "Garratt" locos are "double-enders" in reality as well as in appearance, for they run equally well in either direction and thus make turntables unnecessary.

The "Garratt" consists of two separate engine units connected by a frame carrying the boiler. The result of this arrangement is that the size of the boiler is limited only by the loading gauge, as the fuel and water are carried on the engine frames. There are no axles beneath the fire box, so that this can be made of any depth and volume within reason, with correspondingly good steaming qualities and fuel economy.

The model is constructed on the unit principle and comprises three sections as follows: the boiler and cab unit 2, the water tanks 21 and engine No. 1, and the coal bunkers 8 and engine No. 2. In the model the coal bunkers serve to house the Electric Motor 1 and operating mechanism.

The boiler unit (Fig. 38a) should be constructed first. The main chassis frame is composed of two $1\frac{1}{2}$ " Angle Girders 27 to which the boiler 2 is Bolted by means of Flat Brackets. The boiler is formed by two Meccano Boilers placed end to end. The fire box is represented by $5\frac{1}{2}$ " Flat Girders 28 bolted to the Angle Girders 27, while $3\frac{1}{2}$ " Angle Girders 29 bolted together and secured to the Flat Girders 28 carry two $3\frac{1}{2}$ " Flat Girders 31 overlapped and bolted together as shown. A Flat Plate 32 should be secured between the flanges of the Girders 27. The back of the cab is constructed from $2\frac{1}{2}$ " Strips 26 bolted to 2 " Angle Girders 34. Two $1\frac{1}{2}$ " Flat Girders 35 bolted by $1\frac{1}{2}$ " Strips to further 2 " Angle Girders 34 form the sides of the cab, while the space between the top of the Boiler and the front of the cab roof is filled in by a $2\frac{1}{2}$ " Curved Strip. The cab is now covered by a $2\frac{1}{2}$ " Flat Plate bent slightly to shape and bolted by Angle Brackets to the Girders 34.

A $2\frac{1}{2}$ " Strip should be bolted on the under side of the Girders 27, to form a support

for a Double Arm Crank 33. The bolts securing the Strip pass through the fourth holes from the cab end of the Girders 27.

The portion that houses the driving mechanism is constructed as follows:—A 4-volt Meccano Electric Motor is carried in a chassis built from $7\frac{1}{2}$ " and $2\frac{1}{2}$ " Angle Girders as shown in Fig. 38b. Two $9\frac{1}{2}$ " Strips bolted to the $7\frac{1}{2}$ " Angle Girder 52 of the chassis form a support for a $2\frac{1}{2}$ " x $2\frac{1}{2}$ " Flat Plate 6 (Fig. 38) to which are secured $2\frac{1}{2}$ " Angle Girders 7 to form the buffer beams.

The armature spindle of the Motor carries a $\frac{1}{2}$ " Pinion 1 (Fig. 38b) that engages a 57-teeth Gear 38, on the spindle of which is a further $\frac{1}{2}$ " Pinion engaging a 57-teeth Gear 39, and the Rod of Gear 39 carries a $\frac{1}{2}$ " Pinion engaging a 57-teeth Gear 40, on the Rod of which is a $\frac{3}{4}$ " Sprocket Wheel 41. This Sprocket is connected by Sprocket Chain with a second $\frac{3}{4}$ " Sprocket Wheel 42 carried on the Axle Rod of one pair of the wheels 16. The electric Collecting Shoe 46 (part No. 149) has a $\frac{3}{4}$ " Bolt secured to each end. The bolts are secured to the Angle Girder 44 by double nuts.

From the illustration it will be seen that as the result of the above arrangement the Shoe is spaced away from the Angle Girders 44. The construction of the engine cylinders 49 will be quite clear.

The Plate 6 (Fig. 38) carries a Double Arm Crank in the boss of which is secured a $1\frac{1}{2}$ " Rod 50 (Fig. 38b). On this Rod the pony-truck is mounted pivotally. The

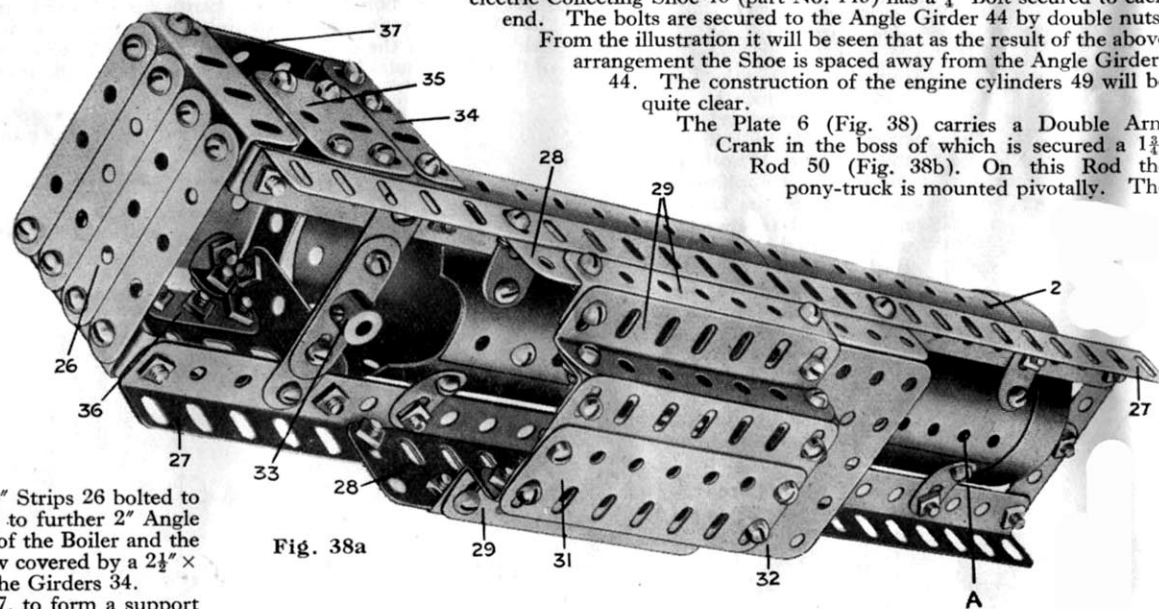

Fig. 38a

Model No. 38 Garratt Locomotive

(continued)

construction of the rear truck being the same as the front one, a description of one of them will suffice for both.

The Wheels 11 (Fig. 38) are carried on $1\frac{1}{2}$ " Rods that are journalled in supports 17 formed from $2\frac{1}{2}$ " Strips joined by Double Brackets. The Double Brackets carry a Double Arm Crank, in the boss of which the Rod 50 (Fig. 38b) is loosely journalled. After placing the truck on the Rod 50 a Collar should be placed on the end of the latter to prevent the truck leaving the Rod.

From Fig. 38b it will be seen that the driving wheels are journalled in the $4\frac{1}{2}$ " and $3\frac{1}{2}$ " Angle Girders 44 that are bolted by eight bolts to connecting pieces 45 (each composed of two single $3\frac{1}{2}$ " Strips placed face to face).

The connecting rods 14 and 25 (Fig. 38) are each composed of two $4\frac{1}{2}$ " Strips overlapped two holes and bolted together. The single Strip thus formed is then placed over Pivot Bolts carried in the wheels 15 and 16 as shown. Both connecting Rods must be spaced from the wheels by Collars placed on the Pivot Bolts between the Strips and the wheels.

The construction of the water tender 21 is shown in Fig. 38. The pony-truck is mounted in a similar manner to that of the rear tender, and the driven wheels are journalled in a like manner to the wheels 15 and 16 with the exception that two $9\frac{1}{2}$ " Girders are used in place of the Girders and Strips 44 and 45 (Fig. 38b).

When the three portions of the model have been completed they may be connected together so that they appear as Fig. 38. To do this proceed as follows. Pass the boss of the Crank 33 (Fig. 38a) over the Rod 47 (Fig. 38b) and then connect up the front unit by passing the hole "A" of the boiler over the $3\frac{1}{2}$ " vertical pivot Rod of the Front unit. Although this latter Rod is not illustrated it is arranged exactly the same as Rod 47.

One terminal of the Electric Motor is connected by wire with one of the 6 B.A. Bolts of the Collecting Shoe 46, as shown in Fig. 38b and the other terminal joined by wire with any suitable point of the chassis, such as one of the Girders 52. Great care must be taken to prevent any metal part of the Collecting Shoe from coming into metallic contact with any portion of

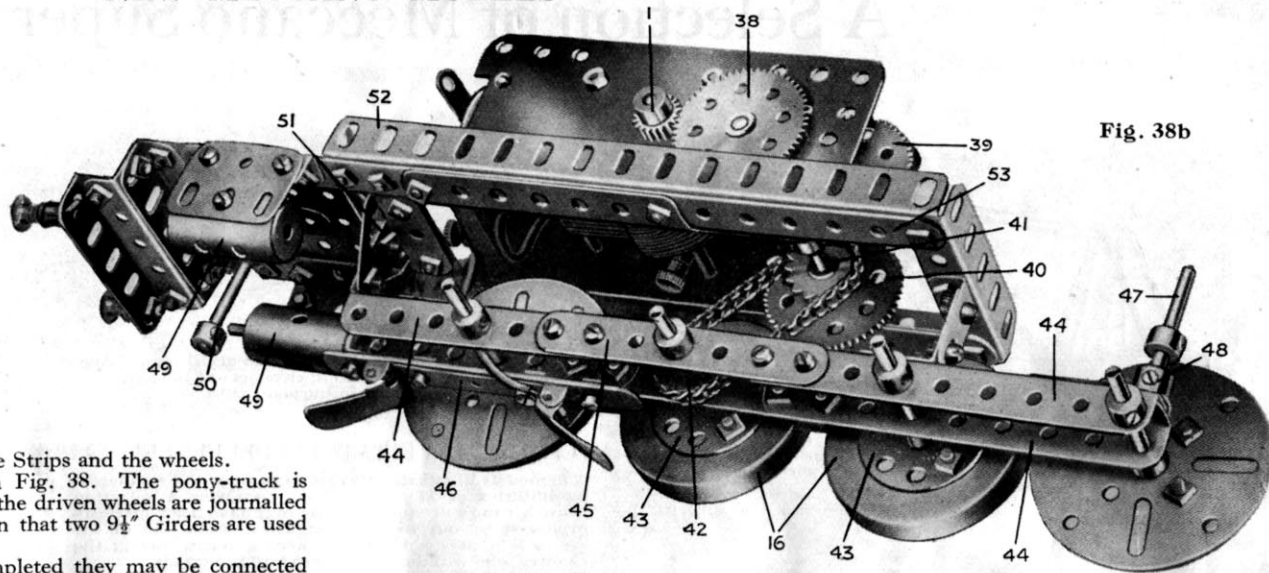

Fig. 38b

the framework, otherwise short circuiting will occur.

Rubber covered wire of the kind used to connect radio H.T. and L.T. batteries is best for making the various connections.

Having completed the model join one terminal of a 4-volt Accumulator to the centre rail of a length of electric railway track, and connect one of the outer rails with the remaining terminal of the accumulator. Place the loco on the track and make sure that the slippers of the Collecting Shoe 46 (Fig. 38a) are in contact with the centre rail. By moving the Motor switch lever the model will be set moving, either forward or reverse according to which way the Motor switch is moved.

Parts required :

4 of No. 1a	6 of No. 9b	3 of No. 18a	5 of No. 62b	7 of No. 111
1 " 2	16 " 9d	4 " 20	4 " 72	4 " 120a
1 " 1b	10 " 9c	8 " 24	5 " 81	2 " 126
12 " 2a	6 " 9f	3 " 26	8 " 94	16 " 137
2 " 3	4 " 10	3 " 27a	2 " 96a	12 " 147b
12 " 5	4 " 11	289 " 37	2 " 103	2 " 149
3 " 6	10 " 12	22 " 37a	10 " 103d	2 " 162
5 " 6a	4 " 12a	16 " 38	7 " 103f	4 " 163
2 " 8	2 " 12b	2 " 48	4 " 103h	6 " 164
2 " 8a	1 " 16	43 " 59	4 " 103k	1 4-volt Electric Motor
10 " 8b	4 " 16b	2 " 62	8 " 109	
2 " 9a	13 " 17			

Model No. 39 Orthopter Flying Machine

This machine has been christened an "Orthopter" because it is propelled by the operator rapidly raising and lowering a pair of hinged wings, just as a bird or winged insect (Orthoptera) does when flying.

The "wings" consist of $5\frac{1}{2}$ " Braced Girders pivotally attached to the body by means of four pairs of Angle Brackets and actuated by means of a $2\frac{1}{2}$ " Strip that is lock-nutted to one of the $2\frac{1}{2}$ " Strips secured in the nose of the "fuselage." Two pieces of cord secured to the other end of this Strip pass over a $\frac{1}{2}$ " loose Pulley and are led thence to the wing tips, so that when the pivoted Strip is moved up and down the wings rise and fall, or "flap" like those of a bird.

A $2\frac{1}{2}$ " x $\frac{1}{2}$ " Double Angle Strip is bolted vertically to the fuselage, and the $\frac{1}{2}$ " loose Pulley, over which passes the cords supporting the wings, is attached loosely to this by means of a $\frac{3}{8}$ " Bolt and lock-nuts.

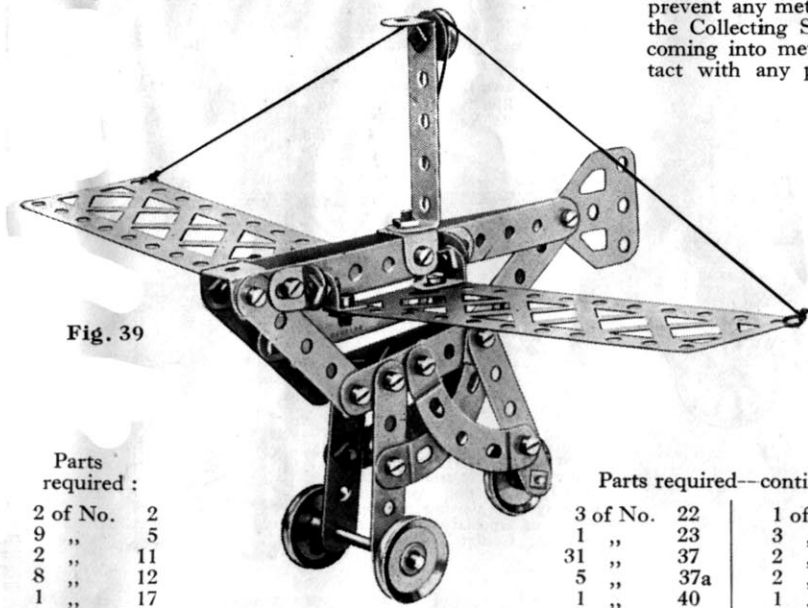

Fig. 39

Parts required :

2 of No. 2
9 " 5
2 " 11
8 " 12
1 " 17

Parts required--continued.

3 of No. 22	1 of No. 48a
1 " 23	3 " 90a
31 " 37	2 " 100
5 " 37a	2 " 111c
1 " 40	1 " 126a

A Selection of Meccano Super Models

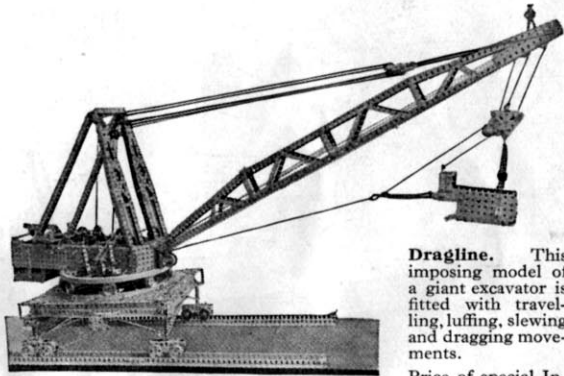

Dragline. This imposing model of a giant excavator is fitted with travelling, luffing, slewing and dragging movements.

Price of special Instruction Leaflet 3d.

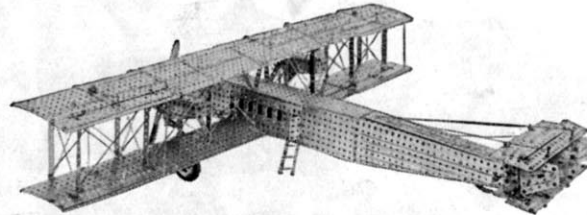

Three-Engine Biplane. This is a realistic model of an "Argosy" machine, fitted with ailerons, elevators and rudders.

Price of special Instruction Leaflet 3d.

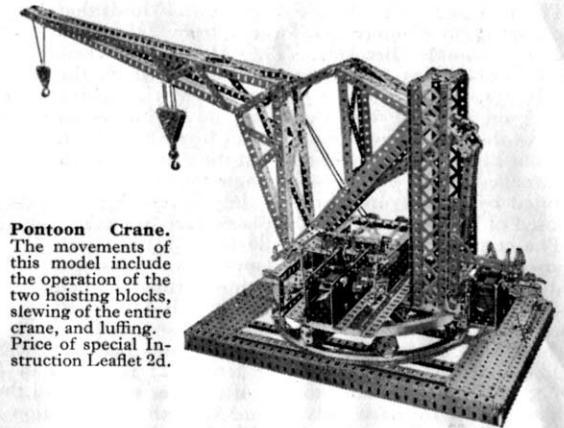

Pontoon Crane. The movements of this model include the operation of the two hoisting blocks, slewing of the entire crane, and luffing.

Price of special Instruction Leaflet 2d.

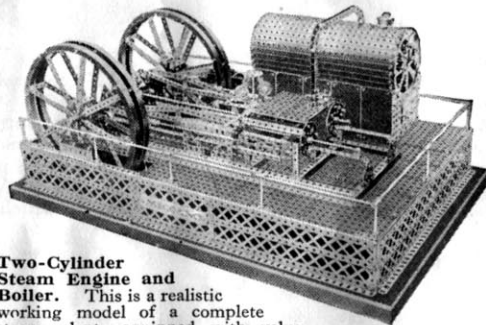

Two-Cylinder Steam Engine and Boiler. This is a realistic working model of a complete steam plant, equipped with valve gear, governor, balanced cranks, etc.

Price of special Instruction Leaflet 3d.

The models illustrated on this page show the wonderful possibilities of Meccano. They comprise a selection from a range of super models that have been specially produced by our expert designers. Each one in the series is a masterpiece and there is not a boy in the country who will not be eager to build them all. These models are so important that we have engaged expert engineers to describe them, and a special leaflet with beautiful half-tone illustrations and detailed instructions has been written for each of them. A descriptive leaflet, giving full particulars of all the models in the series and the prices of the special Instruction Leaflets that are published in connection with them, may be obtained free of charge from your dealer, or direct from

MECCANO LTD.

Binns Road - Old Swan - Liverpool

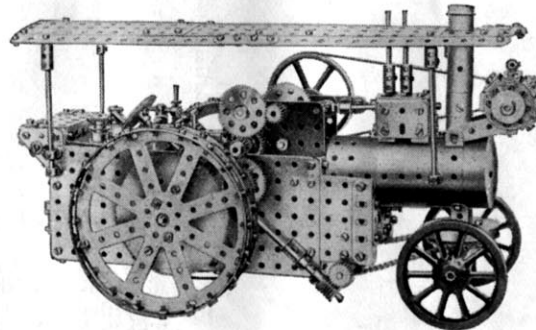

Traction Engine. This is a powerful model capable of hauling heavy loads. It is driven by a 6-volt Motor and is fitted with two speed and reverse gear box, crankshaft, piston, and valve motion, worm-and-chain steering, brake, "dynamo," etc. It is a fine example of the latest Meccano construction.

Price of special Instruction Leaflet 2d.

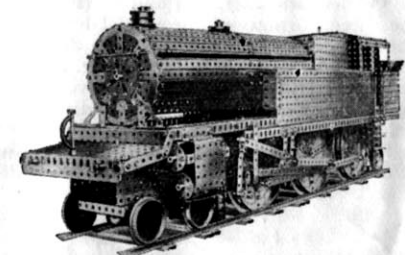

Baltic Tank Locomotive. The driving wheels are operated by an Electric Motor. An accurate reproduction of Walschaerts' Valve Gear is fitted.

Price of special Instruction Leaflet 3d.

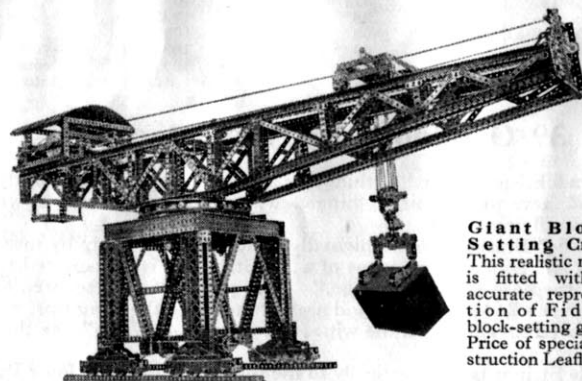

Giant Block-Setting Crane. This realistic model is fitted with an accurate reproduction of Fidler's block-setting gear.

Price of special Instruction Leaflet 6d.

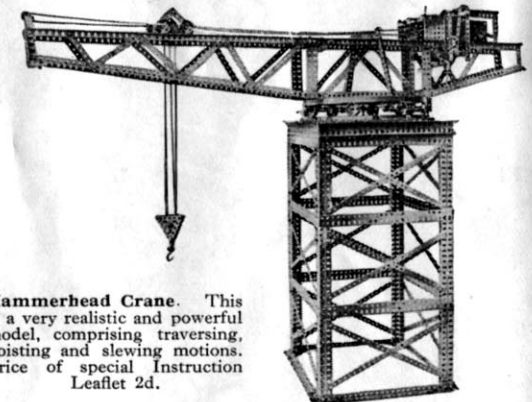

Hammerhead Crane. This is a very realistic and powerful model, comprising traversing, hoisting and slewing motions.

Price of special Instruction Leaflet 2d.

No. 1 Wobble Shaft Variable Speed Gear

The interesting model shown in Fig. 1 is of a new and very ingenious type of infinitely variable speed gear.

The $4\frac{1}{2}$ " Rod 1, which forms the "wobble shaft," is secured to a Universal Coupling that is fixed to a Threaded Pin bolted on the end Flanged Plate. The Bush Wheel 2 is secured to the driving shaft, that carries a hand wheel by rotating which the end of the wobble shaft 1 inserted in the Bush Wheel is caused to describe a circular motion. The wobble shaft itself does not rotate of course. Two $6\frac{1}{2}$ " Rods 3 are held in position in the Flanged Plates by Collars. Two Cranks are secured to each Rod, and each pair of Cranks carries a $3\frac{1}{2}$ " Rod 4 in their end holes.

The $1\frac{1}{2}$ " Strips 5 are free to slide on the Rods 3 and 4, and are moved simultaneously to and fro by means of the $3\frac{1}{2}$ " Strip 6, each end of which is bolted to Double Brackets held between the ends of the Strips 5. The handle provided at the centre of the Strip 6 consists of a Threaded Pin, the shank of which is employed to secure another Double Bracket which slides upon a further $6\frac{1}{2}$ " Rod. Each link 7 connecting the Rods 4 and the wobble shaft 1 consists of a 2" Strip bolted to a Crank that is placed between the lower ends of the $1\frac{1}{2}$ " Strips 5. These Cranks are free to slide on the Rods 4. A Crank 8, having its arm prolonged by a 2" Strip, is secured at one end of each $6\frac{1}{2}$ " Rod 3.

The Cranks on which the Pawls 9 are mounted are quite free to move about the driven shaft and are rocked to and fro by connecting links attached to the Cranks 8, and mounted loosely on the $\frac{3}{4}$ " Bolts carrying the Pawls 9. Each $\frac{3}{4}$ " Bolt is secured to its Crank by two nuts. The Pawls are held in engagement against the teeth of the Ratchet Wheel by pieces of Spring Cord.

When the 3" Strip 6 is pushed towards the Bush Wheel end of the model—where the motion of the wobble shaft 1 is at a maximum—the maximum throw will be imparted via the links 7 to the Rod 4, and the resulting motion of the Cranks 8 imparts a maximum throw to the Pawls operating the Ratchet Wheel. Consequently the driven shaft will revolve at its highest speed. If the Strip 6 is moved in the opposite direction the throw of the links 7 decreases and the speed of the driven shaft falls.

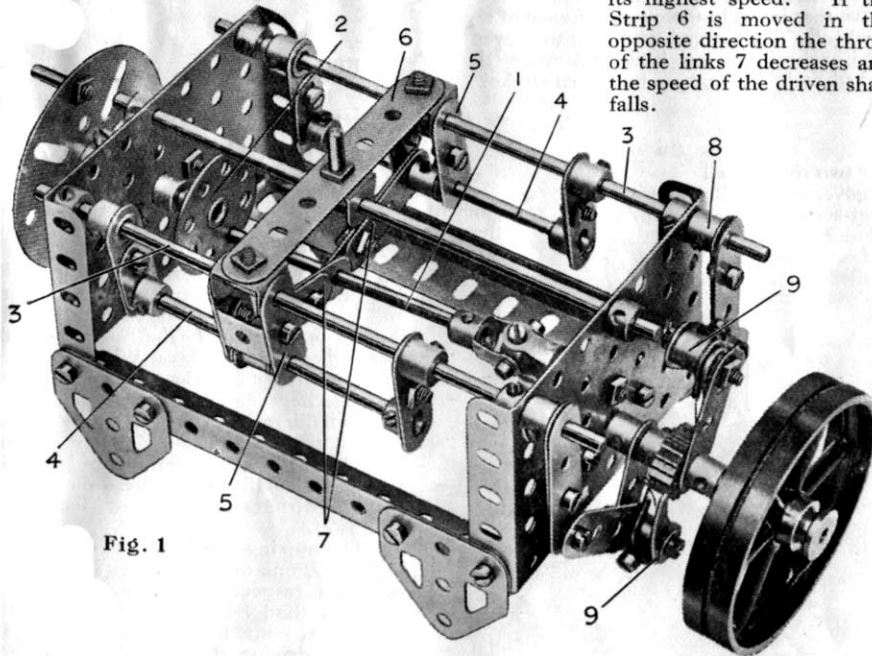

Fig. 1

No. 2 Infinitely-variable Speed Gear

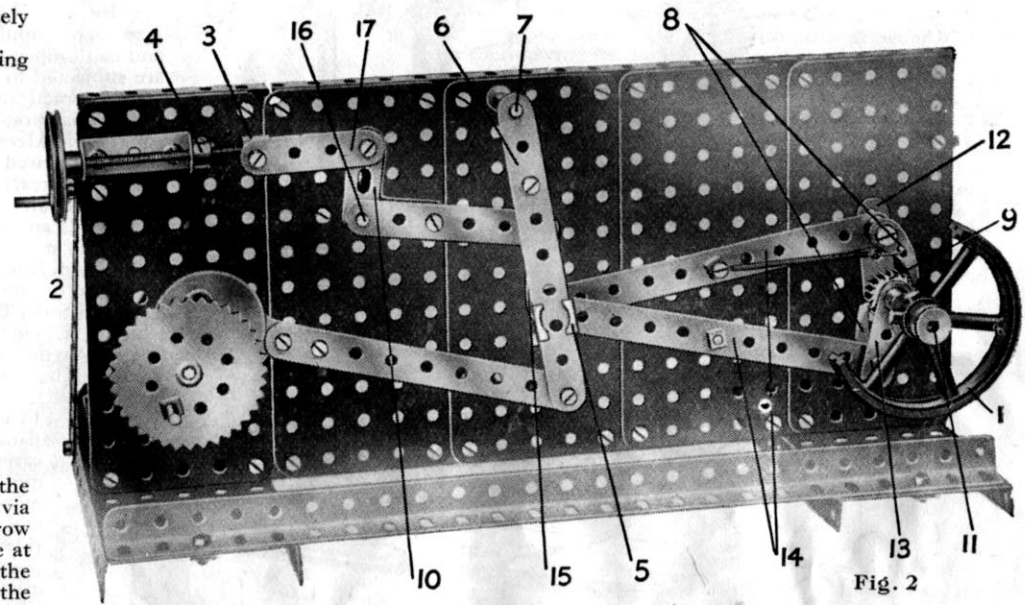

Fig. 2

This mechanism should prove of value wherever a variable gear is required, and many Meccano boys will no doubt find a use for it in their models.

The operation of the mechanism is as follows. If a heavy load is to be placed on the driven shaft carrying the Flywheel 1, then the hand wheel 2 should be turned in a clockwise direction. This will cause the Eye Piece 5 to slide up the $4\frac{1}{2}$ " Strip 6. If oscillations are now transmitted to the bottom of the $4\frac{1}{2}$ " Strip the Eye Piece with the Strips 14 attached will move through a comparatively small arc and maximum leverage will then be applied to the driven shaft. As the Eye Piece moves, the Pawls 8 will rotate the Ratchet Wheel 9, and working under these conditions the model may be said to be in "low gear."

When the hand wheel 2 is rotated in an anti-clockwise direction the Eye Piece 5 is pushed down to the bottom of the Strip 6. Then if the latter is oscillated, the Eye Piece with the Strips attached moves through a larger arc and consequently the Pawls rotate the Ratchet Wheel at a greater speed, but the leverage will be diminished and a smaller force will be exerted on the driven shaft. In this position the model is in "top gear."

The mechanism is constructed as follows. The Rod 11 is first placed in its bearings and a Crank 12 is then mounted upon it with its boss against the Flat Plate. This Crank must be free on the Rod. The Ratchet Wheel 9 is then locked to the Rod next to the Crank and a second Crank 13, with set-screw removed, is pushed into place. The Flywheel 1 lastly is secured to the Rod.

A $5\frac{1}{2}$ " Strip 14 is attached to each of the Cranks by means of the Pivot Bolts which hold the Pawls in place. The other ends of the Strips 14 are pivoted on a $\frac{3}{4}$ " Bolt. Before passing the Bolt through the Collar and Strips a $1\frac{1}{2}$ " Strip 15 should be placed upon it. The Eye Piece 5 is secured to the shank of the $\frac{3}{4}$ " Bolt. The other end of the Strip 15 is attached pivotally by means of a bolt and two nuts to the end of the 3" Strip that is secured to one arm of the Bell Crank 10. The latter rocks about a Rod 16 journalled in the framework.

The 2" Strip 17 is attached to the Bell Crank by a bolt and two nuts while the Threaded Boss 3 is connected to its other end by a bolt held in position by a nut screwed tightly against the Boss. A triple-throw Eccentric and a $4\frac{1}{2}$ " Strip connect the driving shaft and the Strip 6.

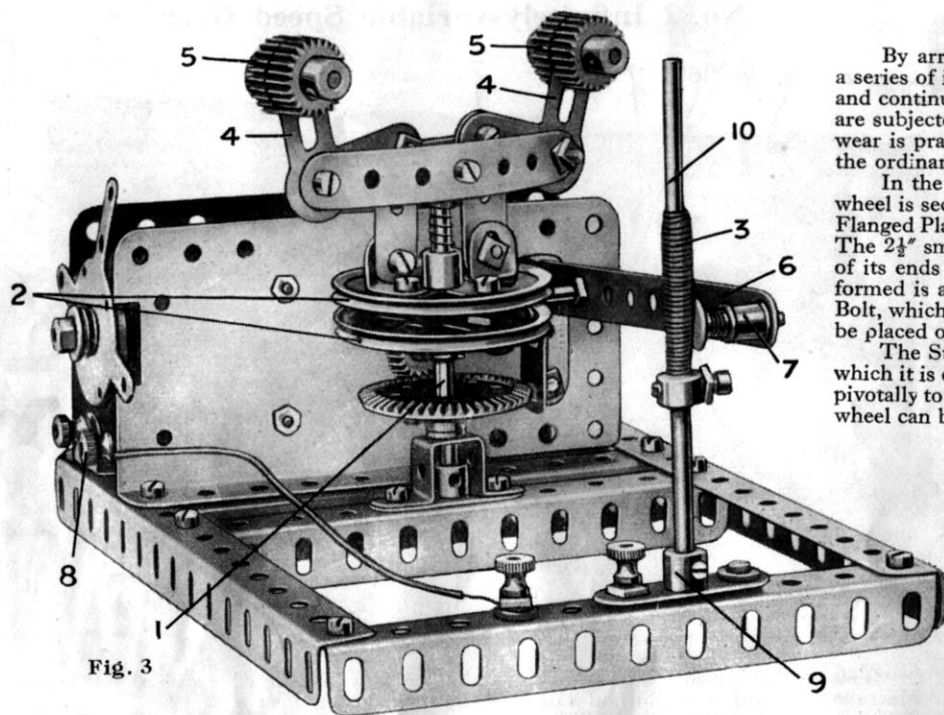

Fig. 3

No. 3 Centrifugal Governor for Electric Motor

This is a device for controlling the speed of the Meccano 6-volt Electric Motor, and consists of two simple Bell Cranks pivoted by $\frac{3}{8}$ " lock-nutted Bolts to the ends of two horizontal $3\frac{1}{2}$ " Strips that are secured to the governor spindle by a Collar (new style). Ordinary bolts are passed through the $3\frac{1}{2}$ " Strips and are inserted in the set-screw holes of the Collar.

The upper extremities of the Bell Cranks 4 are each weighted with two $\frac{3}{4}$ " Pinions, and links composed of $1\frac{1}{2}$ " Strips are attached pivotally by means of lock-nutted bolts to the other ends of the Cranks. The 2" Pulleys 2 are connected rigidly together by means of $\frac{1}{2}$ " Bolts. The latter are first secured to the upper 2" Pulley, and the lower Pulley is then secured to the shanks of the bolts by means of further nuts. The distance separating the two Pulleys should be such that the Threaded Pin carried by the Strip 6 may easily pass between them. The Strip 6 is pivotally attached by a bolt and two nuts to a $1\frac{1}{2}$ " Angle Bracket that is bolted to the side plate of the Motor. A Compression Spring is inserted between the boss of the upper Pulley 2 and the Collar carrying the $3\frac{1}{2}$ " Strips.

The $4\frac{1}{2}$ " Rod 10 is covered for a portion of its length with brown paper. A length of 27 B.I. Resistance Wire (Part No. 312) is laid on in a smooth spiral over the brown paper, and finished off a short distance from the top end of the paper.

The Double-arm Crank 9 is insulated from the Angle Girder to which it is bolted by 6 B.A. Bolts and Insulating Bushes and Washers. One of the 6 B.A. Bolts is provided with a Terminal. Another insulated Terminal is secured to the same girder and is connected to the Motor terminal 8 by a short length of wire. The remaining terminal of the Motor is connected to the frame of the model.

If the speed of the Motor increases the governor weights fly out and cause the Strip 6 to move up the resistance 3. This puts more resistance into circuit and therefore slows down the Motor. If the speed decreases, the contact 7 descends and decreases the resistance, and at its lowest point touches the Collar on the Rod 10. A maximum current is then supplied to the Motor.

No. 4 Worsman's Silent Feed

By arranging two or more ratchets to work alternately on a single shaft, a series of impulses may be imparted so as to produce a comparatively smooth and continuous rotary motion. In practice the teeth of the pawls and ratchets are subjected to excessive wear, but in the Worsman Silent Feed mechanism wear is practically negligible. It forms an excellent substitute for the ordinary ratchet motion when a light drive is required.

In the Meccano model of this interesting mechanism the Fly-wheel is secured to a $3\frac{1}{2}$ " Axle Rod that is journalled in the upright Flanged Plates, and the $7\frac{1}{2}$ " Strip 2 is mounted pivotally on the Rod. The $2\frac{1}{2}$ " small radius Curved Strip 1 has a $2\frac{1}{4}$ " Strip bolted to one of its ends and a $1\frac{1}{2}$ " Strip bolted to the other. The cam unit so formed is attached to the end of the $7\frac{1}{2}$ " Strip 2 by means of a $\frac{1}{2}$ " Bolt, which is secured to the unit by two nuts. Two Collars should be placed on the bolt between the cam unit and Strip 2.

The Strip 2 is rocked about its pivot by the Eccentric 3, to which it is connected by a 2" Strip. This Strip is attached pivotally to the Strip 2, and the motion imparted to the Fly-wheel can be modified by altering its point of attachment.

The second cam unit is attached pivotally to a $1" \times 1"$ Angle Bracket that is bolted to the flanges of the upright Plates. When the shaft carrying the Eccentric is set in motion the Fly-wheel is rotated intermittently by the Curved Strip 1, which when moving in one direction rides freely over the Fly-wheel but in the reverse direction grips the milled groove that is cut in the circumference of the Fly-wheel. The Curved Strip 4 is to prevent the Fly-wheel moving backward when the Curved Strip 1 is making its return stroke.

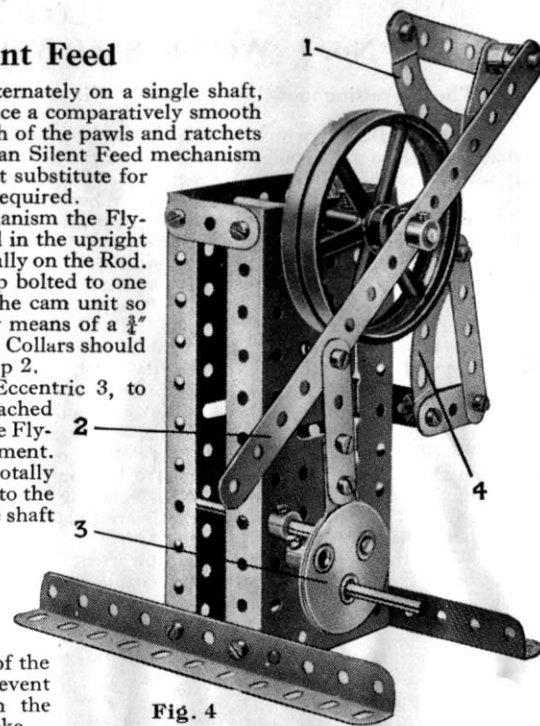

Fig. 4

No. 5 Two-speed Constant-mesh Gear Box

This illustration shows an extremely simple and efficient gear box of the constant-mesh type, one of the great advantages of which is that the shafts do not have to be moved in order to change gear; there is consequently less wear and tear on the gear teeth.

The driving shaft has two rubber shod 1" fast Pulleys 3 and 4 secured to it. Placed against these Pulleys, but loose on the shaft, are a 50-teeth Gear Wheel 1 and a 1" Gear Wheel 2. Also on the shaft are two Compression Springs mounted between Washers and placed one on each side of a Collar 6, which is also free on the shaft. The Collar 6 is connected to a lever 5 and the latter is attached pivotally to the base plate by a bolt and two nuts (see Standard Mechanism No. 262).

On moving the lever to one side or the other, one of the Springs is caused to press its respective gear firmly against a rubber-shod Pulley, and consequently the gear commences to revolve "solid" with the driving shaft, whilst the other gear continues to ride idly upon it.

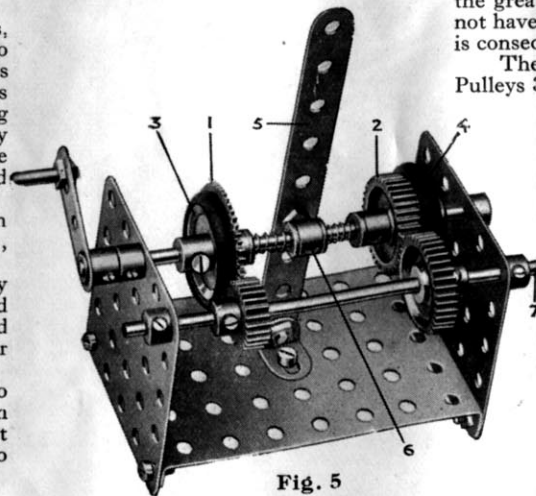

Fig. 5

No. 6 Automatic Speed Governor

Fig. 6 shows a speed regulating device that may be used with advantage to control the speed of the Meccano Clockwork Motor. The mechanism is based upon the centrifugal principle, and the apparatus is so arranged that the revolving weights 5 (Fig. 6a) tending to fly outward are brought to bear upon the inner surface of a Wheel Flange 6 (Fig. 6). The friction so produced checks the speed of the Motor. Incidentally, this type of governor is similar to that already fitted to Meccano Clockwork Motors and Hornby Trains, although the model is built on a much larger scale.

Actual tests carried out with the governor fitted to a clockwork motor yield varying results, since the period during which a motor will continue to operate at a single winding largely depends upon the amount of service that it has given, for a Clockwork Motor will run longer and more freely after it has been in use for some time. However, it is safe to say that the governor will increase the running time of any motor by 25 or 33 per cent. with very little waste of power. The advantages obtainable from such an arrangement applied to any model where it is desired to overcome a tendency to "race" are obvious.

Its construction is quite simple, as will be seen. A Bush Wheel 1 is secured to a shaft 2, which is driven from the main Motor spindle by means of the 57-teeth Gear Wheel and $\frac{1}{2}$ " Pinion shown. Two $1\frac{1}{2}$ " Strips 3 are mounted on Pivot Bolts secured in opposite holes of the Bush Wheel, and are spaced at the correct distance from the wheel by means of a Collar (without set-screw) and Washer placed on each bolt.

The weights consist of two $\frac{1}{2}$ " Pulleys 5 that are secured by their set-screws to the shanks of $\frac{5}{16}$ " bolts passed through the outer ends of the Strips 3, sufficient play being allowed to permit of their free rotation.

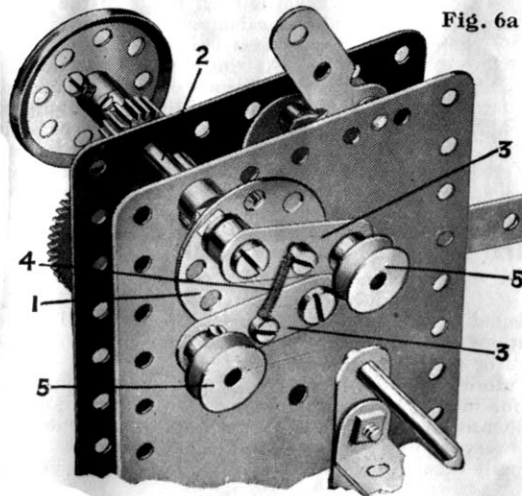

Fig. 6a

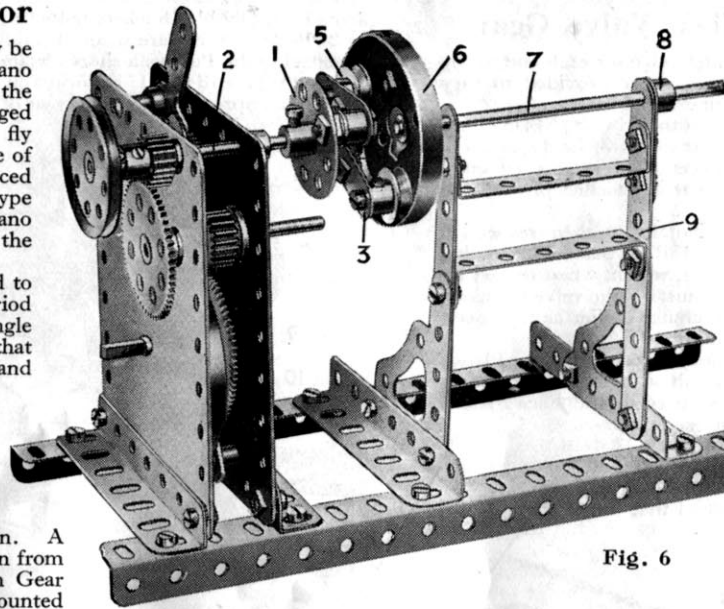

Fig. 6

When stationary, the $1\frac{1}{2}$ " Strips 3 are drawn together by a small piece of Spring Cord 4 (Fig. 6a) secured to the centre of each Strip by a nut and bolt. The Wheel Flange 6 is bolted to a Bush Wheel that is mounted on a shaft 7, the wheel flanges being placed so that its flange encompasses the weights 5. The shaft 7 is held rigidly in position by the set-screw of a Crank 8, which may be bolted to any suitable framework 9. Washers are placed beneath the heads of the two bolts securing the Wheel Flange to the Bush Wheel, to prevent their shanks protruding too far in the interior of the Wheel Flange.

On the speed of the Motor exceeding a certain limit, the centrifugal force exerted by the weights 5 overcomes the Spring Cord 4 and the Pulleys move outward until they make contact with the inner surface of the Wheel Flange 6. This results in the retarding effect already mentioned.

On the other hand, when an extra load is placed on the Motor the armature of the latter tends to revolve at a lower rate of speed and hence the weights 5 press less firmly on the inside of the Wheel Flange. This is due to the fact that the centrifugal forces controlling the movement of the weights decreases in direct proportion to the speed of rotation, and as a result of this, less braking effect is applied to the driving spindle and the Motor tends to keep a more or less constant speed.

This governor will be found very effective in operation and will give no trouble if constructed on the lines suggested.

No. 7 Internal Expanding Brake

When building such models as cranes, motor car chassis, electric lifts, etc., it is necessary to incorporate some form of brake mechanism in order to establish control over the working of the model. There are many types of brake gear, each having its peculiar advantages when used in the correct manner, but the two most popular types are known as external contracting and internal expanding respectively.

An external contracting brake is a fairly simple matter to reproduce in Meccano—a piece of cord tightening round the groove of a Pulley Wheel is an excellent example—but the design of an internal expanding brake is altogether another problem. This latter kind of brake receives a great deal of attention from Meccano model builders, however, and Fig. 7 shows a good example of the type. It is easy to construct, simple and efficient in operation and may be fitted to numerous models.

Two Collars serve as brake shoes and when applying the brake these are pressed against the inner side of a Wheel Flange 1 secured to the Rod 4, which is to be controlled. (In the illustration the tip of one of the Collars can be seen just over the edge of the Face Plate 3). The Collars are fitted with ordinary bolts in place of their grub screws, and these bolts are connected one to the other by a short length of Spring Cord. The same bolts serve to secure the brake Collars to $\frac{1}{4}$ " Bolts 2 passed through slots in the Face Plate 3. The latter is bolted rigidly to the framework of the model, the shaft 4 rotating freely in its boss.

Three Washers are placed on each of the Bolts 2 in order to space their heads at the correct distance from the Face Plate. Two $2\frac{1}{2}$ " Curved Strips 5 (small radius) are bolted to a 3" Strip 6 that pivots about the Rod 4, and the lower end of this Strip 6 is connected by cord or other means to the operating brake lever. On moving the lever the Strips 5 are rocked about the Rod 4 and the Bolts 2 are pushed outward along the slots in the Face Plate, thereby applying the brake shoes to the Wheel Flange 1. When the hand lever is released the brake is returned to the "off" position by means of the Spring Cord stretched between the brake shoes. A brake of this type would form an excellent braking unit for incorporating in a motor car chassis, while no doubt many other uses can well be found for it by an ingenious Meccano boy.

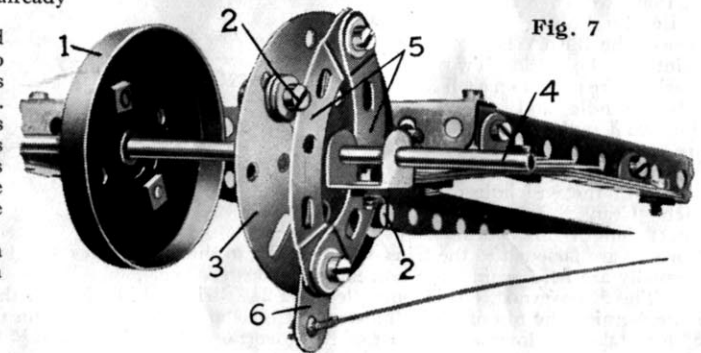

Fig. 7

No. 8 Demonstration Model of Corliss' Valve Gear

In the Corliss gear there is a separate exhaust and steam inlet valve for each end of the cylinder. Each valve is given an oscillatory movement and means are provided to vary automatically the cut off by a centrifugal governor as the engine speed alters.

A Bush Wheel 2 is free to turn about a Pivot Bolt secured to the $5\frac{1}{2}'' \times 3\frac{1}{2}''$ Flat Plates forming the sides of the cylinder block and links connecting the four valves 7, 7a, 11, and 11a are attached pivotally to the Bush Wheel by $\frac{3}{8}''$ Bolts. The Eccentric 1 is secured on a $4\frac{1}{2}''$ Rod and is connected to the Bush Wheel 2 by a $5\frac{1}{2}''$ Strip that is attached pivotally to the end of the Strip 14 by a Pivot Bolt.

The two exhaust valve Cranks 11 and 11a are attached pivotally to their respective links by lock-nutted bolts, the cranks being mounted on the ends of 3'' Rods that are journalled in the Flat Plates. These Rods represent the rotary Corliss valves, which, when rocked by the Bush Wheel 2, alternately open the ends of the cylinder to exhaust. The valve Cranks 7 and 7a are each operated by a trip mechanism, which trips the cranks earlier as the speed of the engine increases, so diminishing the amount of steam admitted.

The Face Plates 3 and 3a are mounted loosely on $4\frac{1}{2}''$ Rods journalled in the Flat Plates. Each trip 4 and 4a consists of two $1\frac{1}{2}''$ Strips and a Flat Bracket bolted together in the form of a triangle, the apex of which is pivoted on a Threaded Pin secured to the Face Plate 3 or 3a. In the construction of each of the trips 4 and 4a the set-screws extracted from Bush Wheels, etc., are used instead of ordinary bolts. A $\frac{1}{2}'' \times \frac{1}{2}''$ Angle Bracket is bolted to each trip as indicated in the illustration. Before placing the trips on the Threaded Pins the connecting links from the Bush Wheel 2 should be mounted on the Pins. Here it should be noted that the connecting links for the exhaust Cranks are slightly bent to form an efficient connection, as also is the connecting link to the Face Plate 3a, which has to be bent towards the Face Plate to clear the lower edge of the trip 4a.

Each Bush Wheel 5, 5a (shown partly cut away) has an ordinary bolt inserted in the set-screw hole, and both must be quite free on the valve spindles. A 2'' Strip is bolted to each Bush Wheel, so that the Bolt 6 on the boss of the Bush Wheel 5 is pointing—to use a clock face as a comparison—to 5 o'clock, while the Bolt 6 on the boss of the Bush Wheel 5a points to 10 o'clock. Two Washers are placed on each valve spindle and lastly the two Cranks 7 and 7a are secured in place. A $\frac{1}{2}'' \times \frac{1}{2}''$ Angle Bracket is bolted in the end hole of each Crank as shown. Short lengths of Spring Cord 18 are fastened to the trips 4 and 4a and to the Face Plates 3 and 3a, so that the trips normally are held against the bosses of the Bush Wheels.

The 5'' governor Rod is journalled in a $2\frac{1}{2}''$ Strip and in a hole of the $5\frac{1}{2}'' \times 2\frac{1}{2}''$ Flanged Plate forming the top of the cylinder, one Collar and three Washers on the lower end of the 5'' Rod take the downward thrust of the governor. The links 12 ($1\frac{1}{2}''$ Strips) are attached

pivotaly to Double Brackets bolted to the Bush Wheel 15 and at their lower extremities to the 2'' Pulley 10 that are secured rigidly together by $\frac{1}{2}''$ Bolts, a Collar and Washer on each bolt spacing the Pulleys a short distance apart. The drive for the governor is taken off the Sprocket Wheel 13 to a 1'' Sprocket on a short Rod that is journalled in a Double Bent Strip bolted to an upright Strip at the rear of the model. The short Rod carries a $1\frac{1}{2}''$ Contrate 17 that meshes with a $\frac{1}{2}''$ Pinion on the 5'' Rod.

The Simple Bell Crank 9 is bolted to a Crank secured to the 3'' Rod carrying the Bush Wheel 8 and one of its arms is extended by a 2'' Strip that has a Threaded Pin bolted to it, so that the Pin rests in the space between the Pulleys 10. Two Collars (new style) are attached in diametrically opposite holes in the Bush Wheel 8 and the $1\frac{1}{2}''$ Rod 16 is attached to the 2'' Strip by means of an End Bearing, while the 2'' Rod 15a is attached to the Strip on the Bush Wheel 5a in a similar way.

In the illustration the Crank 7a is about to be lifted by the Angle Bracket on the trip 4a engaging that on the Crank as the trip rises. As the trip moves, it rides up the Bolt 6, which thrusts it outward to the left. Presently the Crank 7a is released and flies back under the action of a piece of Spring Cord attached to a Crank secured to the valve spindle at the rear of the model. This Crank normally is held by the Spring against a stop consisting of a Threaded Pin. (The Crank 7 is controlled in a similar manner).

In the case of the left-hand valve the Crank 7 is drawn downward by the trip 4 instead of upward as in the case of the right-hand valve. When the left-hand valve is open to steam the right-hand exhaust valve is open, and vice versa.

As the governor weights fly out with increase of engine speed the Pulleys 10 rise and pull up the arm of the Bell Crank 9, so partially rotating the Bush Wheel 8. This in turn alters the position of the Bush Wheels 5 and 5a, so that the trips ride up their respective bolts and trip the Cranks 7 and 7a earlier in the stroke and cause the engine to work with a shorter cut off. The Angle Brackets on the trips and Cranks 7 and 7a must be adjusted very carefully.

The Corliss valve gear was invented by an American engineer Corliss in 1849 and is used in one of its many modifications on most of the best stationary engines. It is not, however, popular for locomotive or marine engine work.

A form of gear that is coming more and more into favour for use on locomotives is called the Walschaert gear, while for many years marine engines have been equipped with the very simple but efficient Stephenson gear. This latter was originally invented for locomotives and for a long period was very popular for this class of engine, but nowadays it has lost favour and is now used but rarely except in connection with marine engines of the reciprocating type.

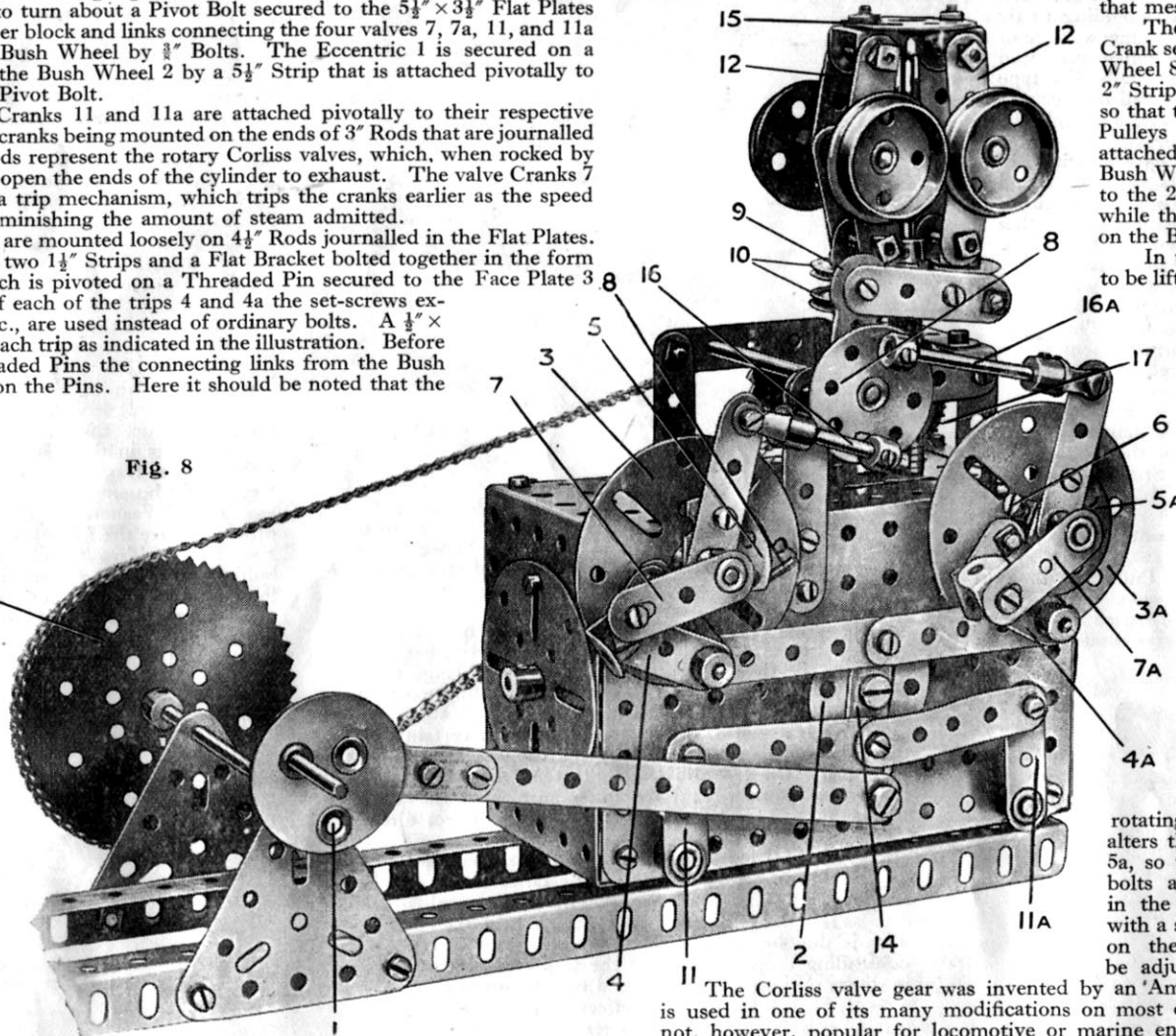

Fig. 8

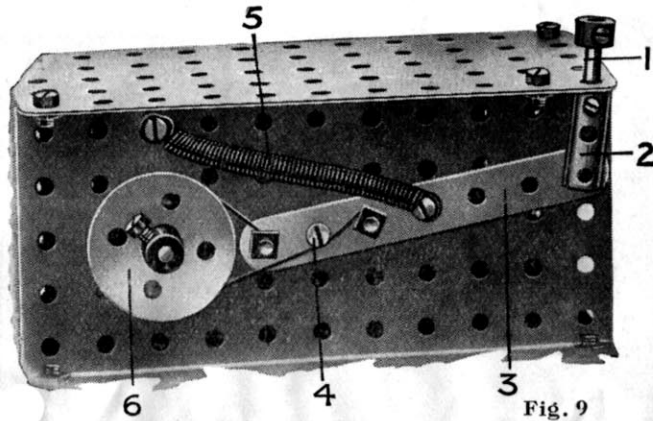

Fig. 9

No. 9 Push Button Brake Control

The Strip 3 pivots upon the shank of a grub screw inserted in the threaded bore of the Strip Coupling 2, and the Strip is also mounted pivotally on a $\frac{3}{8}$ " Bolt 4 secured to the frame by means of two nuts arranged one on each side of the Flanged Plate (see Standard Mechanism No. 262).

A Cord tied to the Strip 3 passes round a Flanged Wheel 6 on the shaft to be controlled, the other end of the cord being secured on the opposite side of the pivot 4. The Spring 5 normally keeps the push-button 1 raised, and the cord grips the Flanged Wheel 6. By gently depressing the Button and Rod 1 the cord becomes slack and the Wheel 6 is free to revolve.

No. 10 Safety Catch for Winding Gears

The spring 3 is mounted on the Crank Handle 1 between the Collar 4 and a washer. The spring normally holds the Collar 2 against the inner side of the plate. It will be noted that the set-screw of the latter Collar has been replaced by a $\frac{3}{8}$ " Bolt, and should the Crank Handle commence to rotate, the head of this bolt strikes against the stop 5.

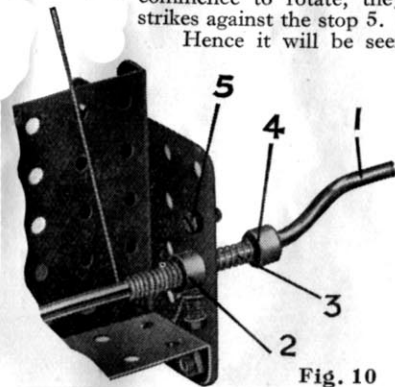

Fig. 10

Hence it will be seen that in order to operate the model it is necessary to push the Crank Handle inward slightly. Immediately pressure is removed from the handle 1, the Collar 2 slips back to its normal position, and the $\frac{3}{8}$ " Bolt strikes the stop.

No. 11 Siemens' Chronometric Governor

In almost every type of engine, certainly in all steam engines, an efficient means of regulating the speed must be provided, and perhaps one of the most ingenious and effective methods is the Siemens' Chronometric Governor, of which a Meccano model may be constructed as shown in Fig. 11.

The $\frac{3}{8}$ " Bevel Wheel 2 is secured near the lower end of the $3\frac{1}{2}$ " Rod 1. The Face Plate 3 is fastened to the lower end of a $1\frac{1}{2}$ " Rod that is journaled as shown, and a $\frac{7}{8}$ " Bevel Wheel is secured near its upper end. The extreme ends of both the upper $3\frac{1}{2}$ " Rod and lower $1\frac{1}{2}$ " Rod are inserted in opposite ends of a Coupling, in the centre transverse hole of which is secured a 2" Rod carrying the $\frac{7}{8}$ " Bevel Gear 4. The two first-mentioned Rods are free to rotate in the ends of the Coupling and the Bevel 4 meshes with the two other Bevels.

When the handle 1 is rotated the drive is transmitted via the Bevels 2 and 4 to the third Bevel on the vertical $1\frac{1}{2}$ " Rod, and therefore the latter is driven in the reverse direction to that in which the handle 1 is turned. The Bevel 4 is quite free to rotate about its Rod, of course.

The pendulum 5 consists of a 5" Rod weighted with four Flanged Wheels and suspended by means of a ball-and-socket joint. The latter consists of a Swivel Bearing 6 secured to a $1\frac{1}{2}$ " Rod that is journaled in the $5\frac{1}{2}$ " x $\frac{1}{2}$ " Double Angle Strip 7 and also in a Double Bent Strip 8. As the Rod 5 must rotate freely in the collar of the Swivel Bearing 6, the set-screws inserted in the collar are provided with nuts that are locked against the sides of the collar to prevent the shanks of the screws touching the Rod 5.

Another Swivel Bearing 9 is free to turn about a Pivot Bolt, the shank of which is gripped in the boss of an Eye Piece (new style). The set-screws in this Swivel Bearing should be locked in a similar manner to those of the Bearing 6 so that their shanks do not grip the Pivot Bolt. The Eye Piece slides on a $2\frac{1}{2}$ " large radius Curved Strip 8, which is rigidly attached to the Face Plate 3 by means of two $\frac{1}{2}$ " x $\frac{1}{2}$ " Angle Brackets.

The Crank 10 is mounted on a spindle that in practice operates the throttle valve. It is connected to the 2" Rod 11 and the latter is attached pivotally to the Crank by means of an End Bearing, its other end being attached to the 2" Rod of the Bevel 4 by a Swivel Bearing. The movement of the Crank 10 is limited by stops in the form of two $\frac{3}{4}$ " Bolts secured to each end of a $1\frac{1}{2}$ " Strip, and another Crank secured to its spindle carries a balance weight or counterpoise consisting of a 1" Pulley Wheel bolted to a 3" Strip.

The following is a brief summary of the action of the model. A certain amount of energy is required to maintain the pendulum 5 at a constant angle with the vertical. Since the three Bevel Wheels form an epicyclic train, either the Bevel 2 and the lower Bevel fixed to the Rod of the Face Plate 3 must turn at the same rate or Bevel 4 must run round the teeth of the lower Bevel. The latter is connected to the pendulum 5 and its rotation cannot be maintained without a constant expenditure of energy.

Therefore the tendency of the lower Bevel is to lag behind the Bevel 2 and cause the Bevel 4 to travel round its teeth. But this movement of the Bevel 4 is checked by the counterpoise.

The governor is brought into action when the velocity of the engine is sufficient to keep the counterpoise raised slightly.

Because the lower Bevel is connected to a heavy revolving mass it can only change its velocity gradually, but the counterpoise is in equilibrium. Hence the slightest increase in velocity of Bevel 2 will be sufficient to raise the counterpoise further and so vary the steam valve opening.

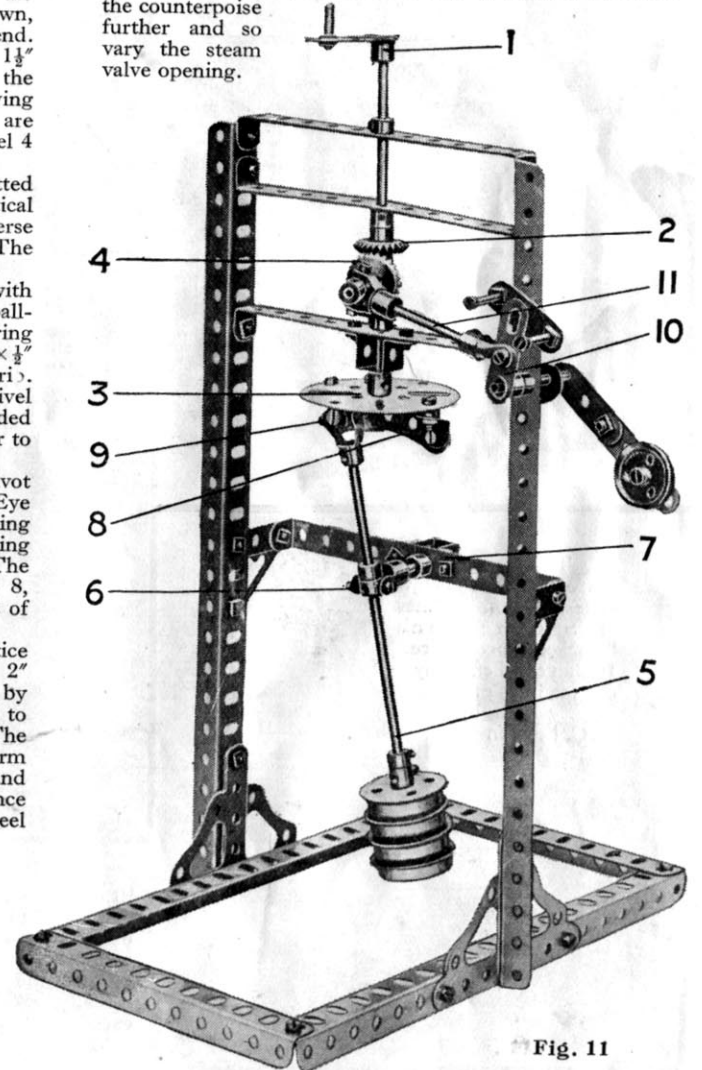
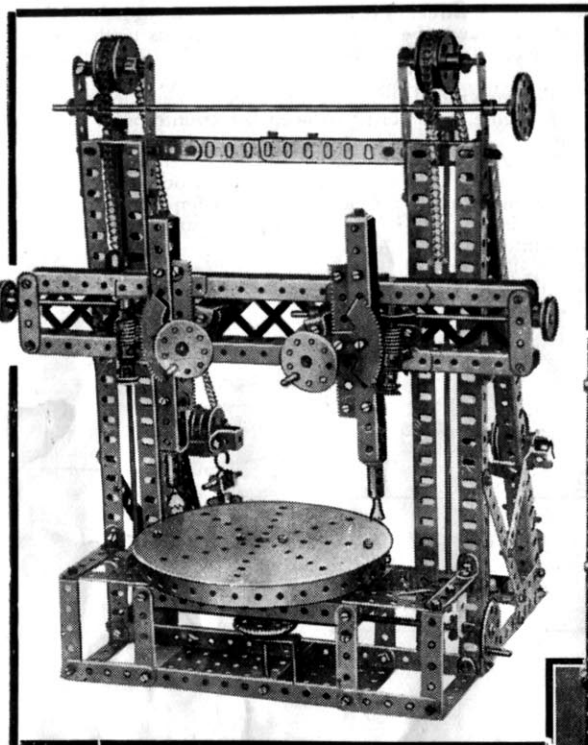
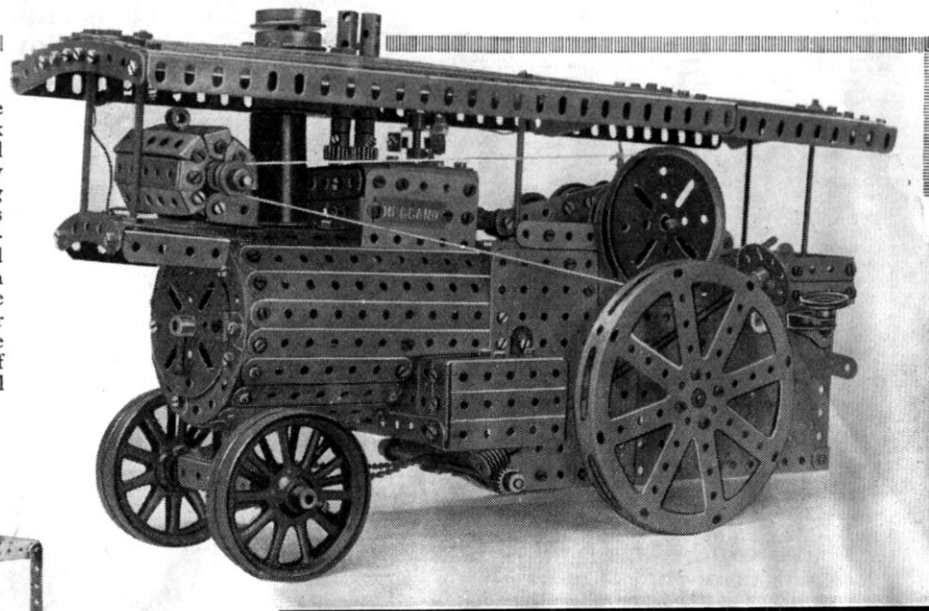

Fig. 11

A SELECTION OF PRIZE-WINNING MECCANO MODELS



The circular planing machine (left) was built by J. Sturrock (Barrow-in-Furness). The tool holders may be adjusted to any angle and the saddles moved along the balanced cross slide by means of Threaded Rods while the elevation of the cross-slide is regulated by Threaded Rods rotated from $\frac{1}{2}$ " Pinions and Contrate Wheels. Many other interesting features are included in the design of this realistic model machine tool.



The above model is a faithful reproduction of a powerful steam tractor. It was built by A. T. Locke (Shottery) and is driven by means of a Clockwork Motor. Steering is effected by chains attached to the front axle and actuated through worm and pinion mechanism. As will be seen, the model is equipped with cylinder, governor and "dynamo," the latter being driven from the engine flywheel, thus conforming to actual practice.

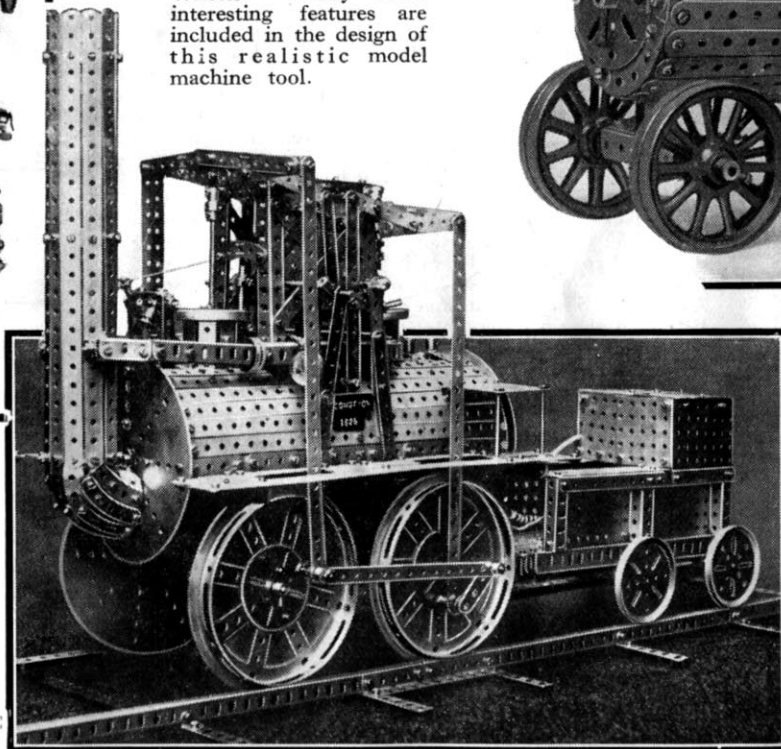

The above illustration shows a very fine model of Stephenson's "Locomotion No. 1." It was built by R. S. Miller (Newark) to a scale of 1-9. Note the queer position of the cylinders, with their vertical piston-rods and quaint "grasshopper" motion by which power is transmitted to the driving wheels.

On the right is a wonderful model of a sewing machine that actually works. The needle mechanism is very intricate and really excellent sewing may be done on the machine. It is undoubtedly a splendid tribute to the ingenuity and patience of its builder, Alex. Van Dam (Amsterdam).

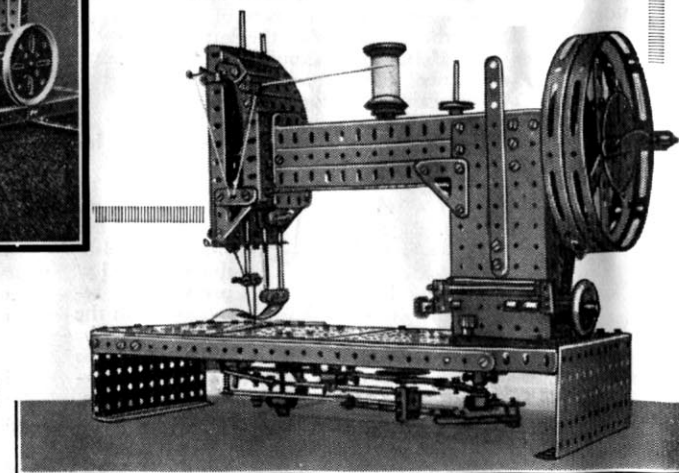

The cleverly-built model illustrated below is designed on the lines of Stephenson's "Rocket" locomotive. It is an excellent copy of its famous prototype. Built by N. C. Bowron (Bristol).

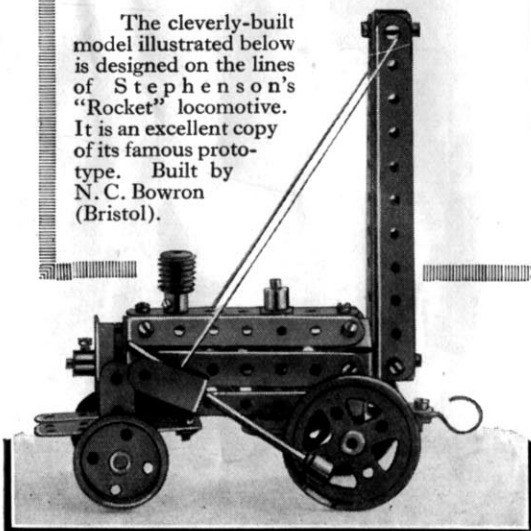

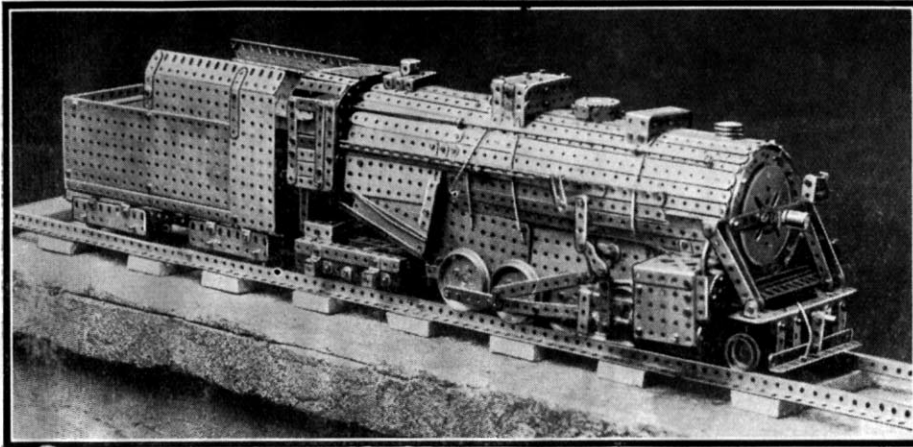

This particularly fine example of a model locomotive (above) was submitted by E. W. Baker (Frinton-on-Sea). The model represents a 2-8-4 booster-fitted engine in use on the Boston and Albany Railways, U.S.A. It is driven by a 6-volt Electric Motor, the necessary current being supplied by a Meccano Accumulator carried in the tender.

The realistic two-seater motor car (below) by J. Russel (Edinburgh) includes a dickie, luggage carrier, etc. The Motor 'bus (right) is modelled on the famous type so familiar in London, and appears almost as sturdy and comfortable to ride in as its prototype. Built by R. Webber (London).

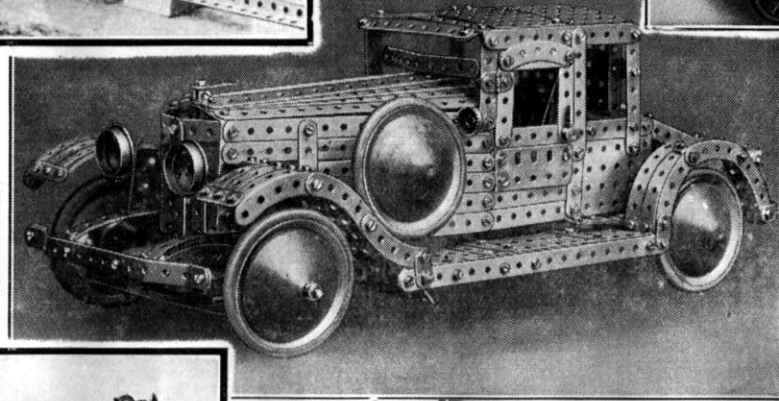
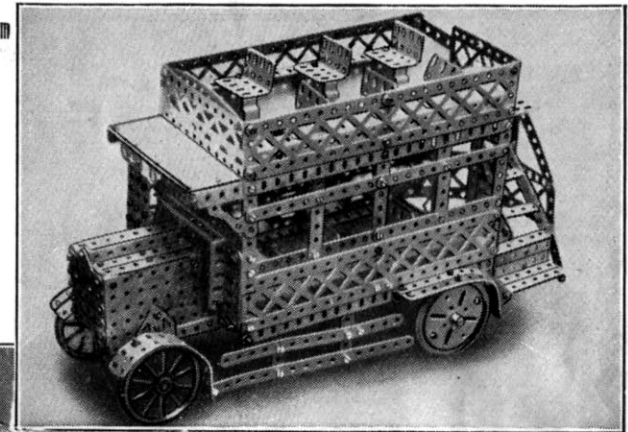

The pleasing model shown below is of a popular type of street tramcar, and was built by H. Dean (Manchester). It is an excellent example of neat, straight-forward construction.

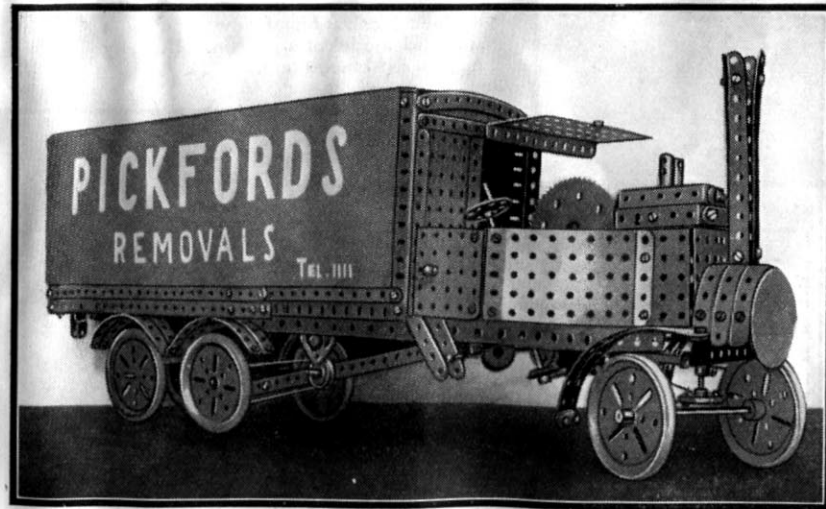

The reproduction on the left shows a very fine model of a six-wheeled steam wagon by F. R. Higgs (Leicester). The mechanism includes Sprocket Chain drive and worm and pinion steering gear.

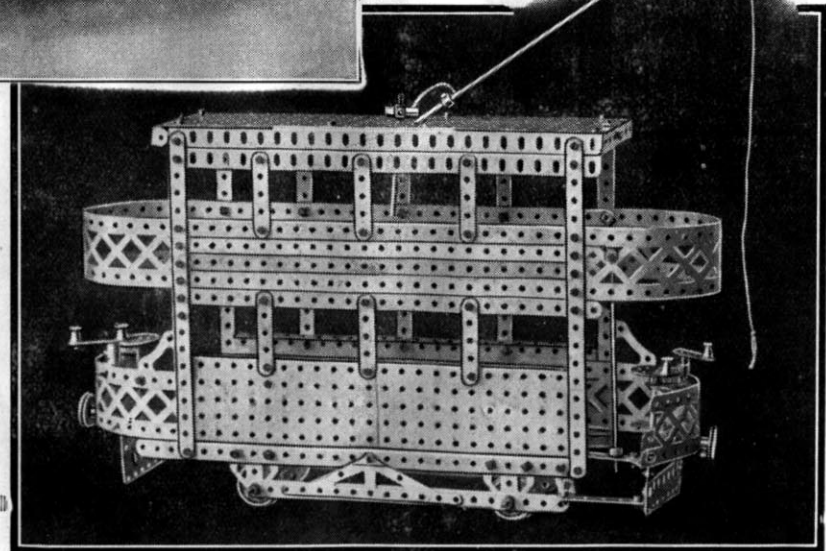

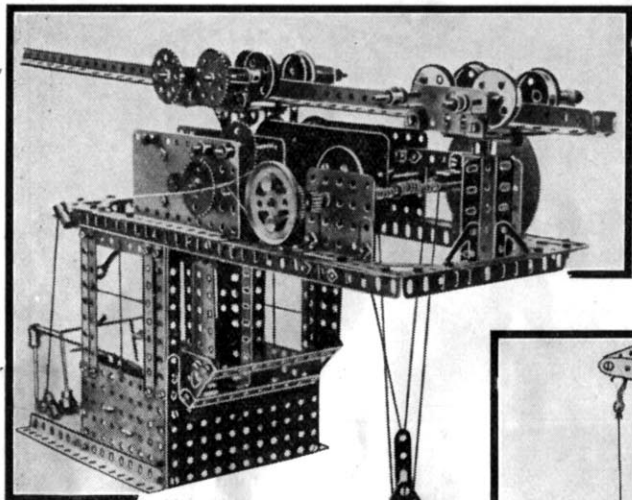

The combined locomotive and crane shown below was built by R. J. Webb (Wallasey). It is of a type used sometimes in place of the ordinary railway breakdown crane, and is mounted on roller bearings. When not in use the jib is lowered on to a cradle mounted on top of the engine tank.

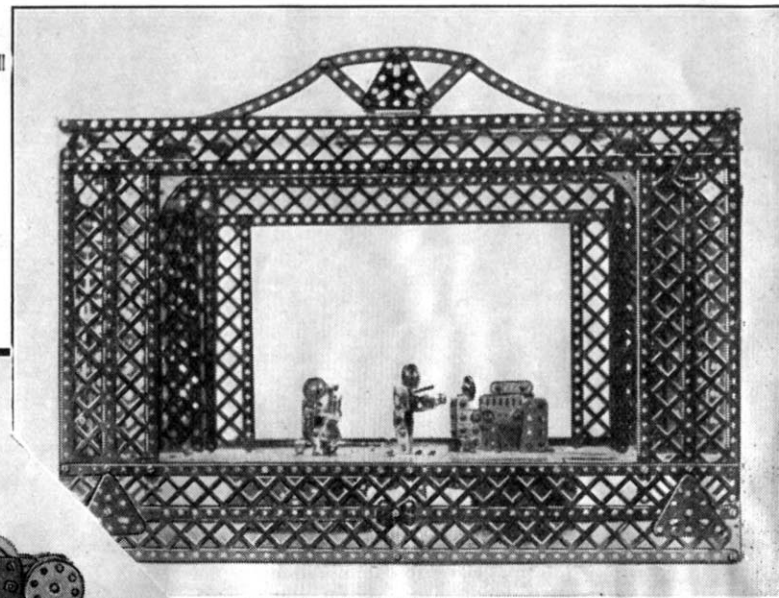

The ingenious model theatre (above) was built by M. Saxby (Hawkes Bay, N.Z.). The "orchestra" comprises a pianist, violinist, and a cellist, and the figures may be set in motion by means of cords worked from behind the scenes. The illustration below shows a splendid model of a galleon. Built by A. Jones (Manchester).

This cleverly designed model of a mono-rail electric crane (above) was constructed by C. Roger (Paris) and is of the type used in large locomotive shops, etc.

The lower illustration shows a model of the famous Panderno bridge in Italy. The builder (M. Cavillini, Rome) has chosen an ideal site for his model.

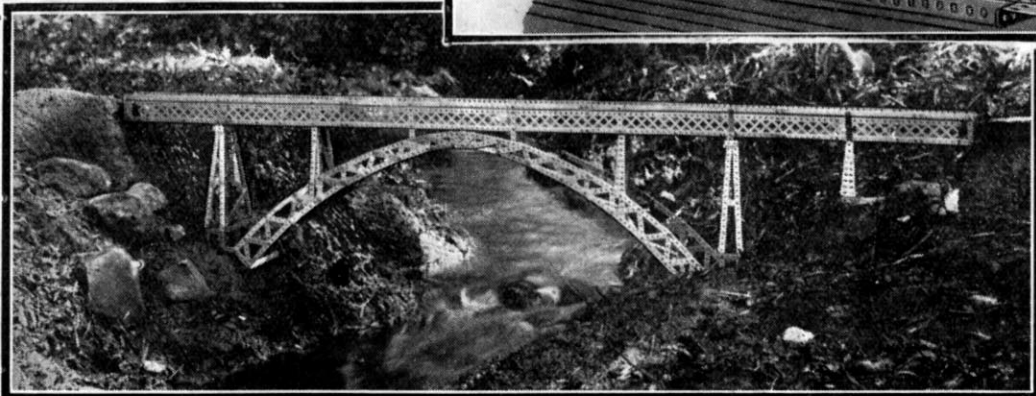
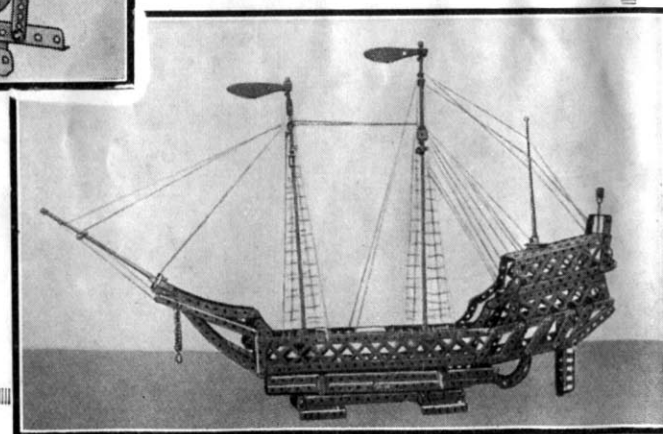
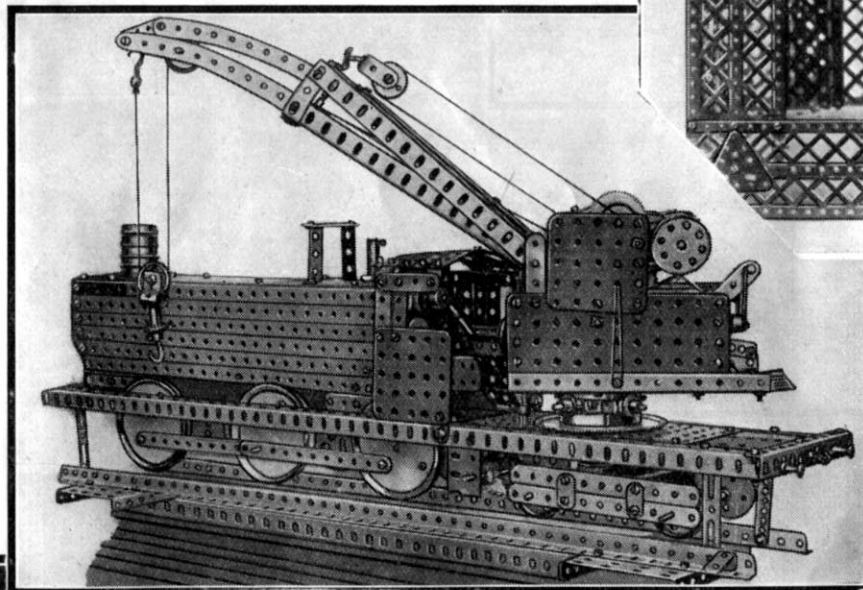

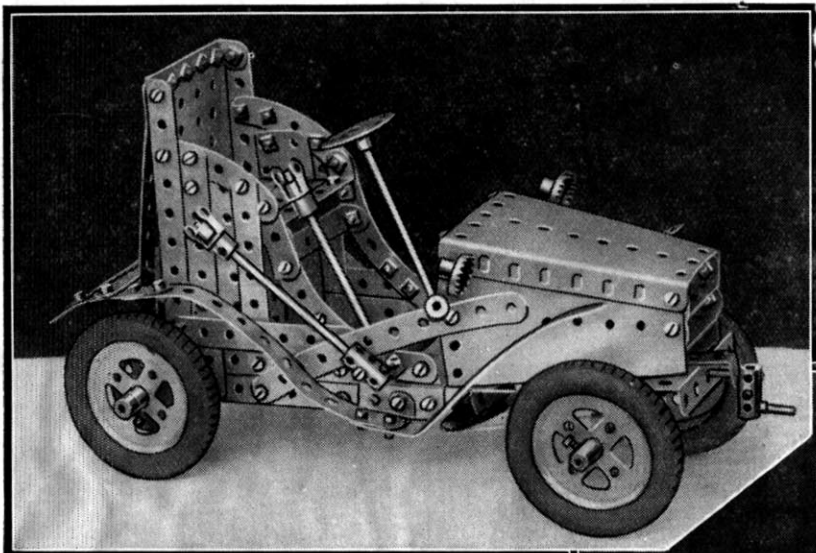

The photograph reproduced below was faked so that the designer (J. W. Vipond, Sunderland) appears to be standing with one foot upon his handiwork. Quite apart from the novelty of the photograph, the model is one of considerable interest. It has a hinged door, starting handle and radiator bars. The inscription on the sides of the lorry, together with the Dunlop Tyres and miniature sacks, give a most realistic finish.

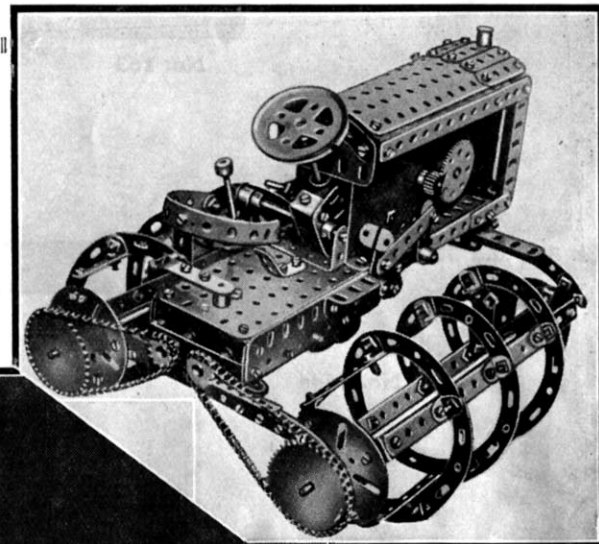

The interesting model shown above was submitted by W. R. H. Temple (Shanklin). It is patterned on the "Swift" motor car of 1904 and affords a striking illustration of the rapid development of motoring during the past twenty years or so.

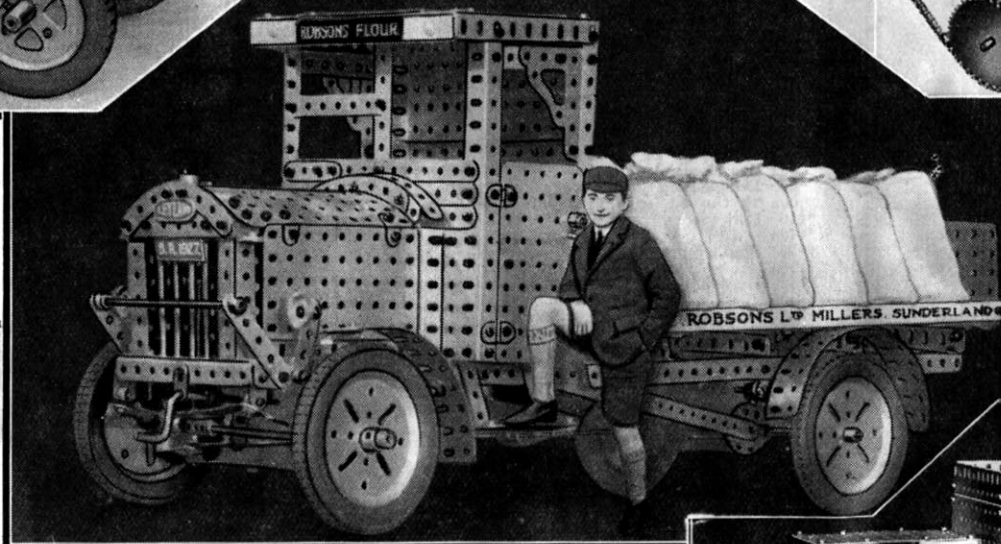

Above is a fine model of a motor snow plough built by W. B. Cole (Felbridge). The ploughs are operated by frictional driving mechanism. Note the realistic arrangement of the controls, etc.

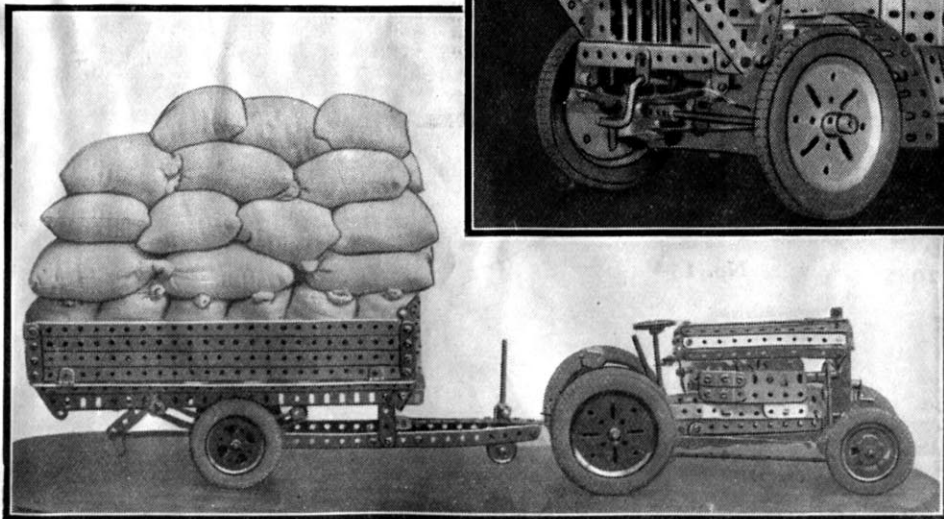

The fine models on the right and left were built by G. V. Hudson (London) and H. T. Bates (West Bromich) respectively.

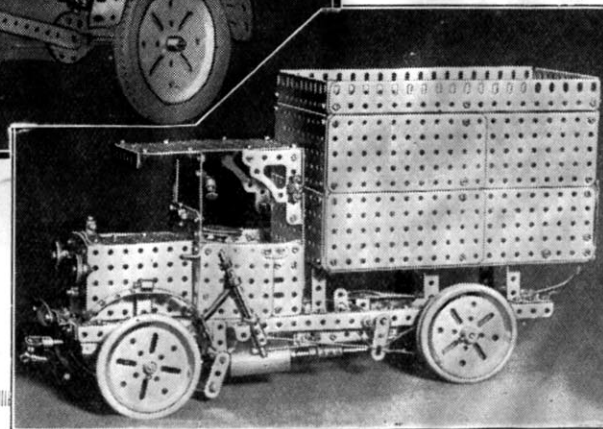

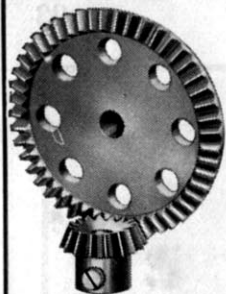

Nos. 30a and 30c



No. 165



No. 163

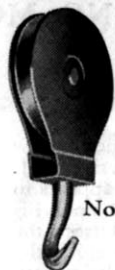

No. 151



No. 152



No. 153



No. 62b



No. 164

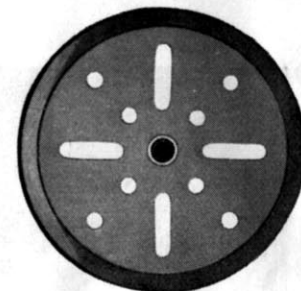

No. 19b



No. 154a

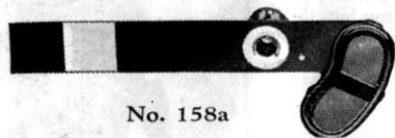

No. 158a



No. 156



No. 154b



No. 50a



No. 26a



No. 166



No. 116a

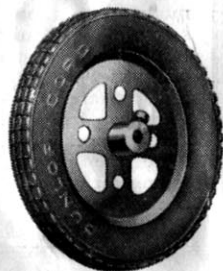

No. 142a

New and Improved Meccano Parts

On this page we illustrate most of the recent additions to the Meccano system. Every Meccano boy will find these parts useful in building the larger and more interesting models. They are real engineering parts in miniature.

	s.	d.		s.	d.
19b 3" dia. Pulley Wheel ...	each	7	154a Corner Angle Brackets, right-hand $\frac{1}{2}$ doz.	6	
20b Flanged Wheels, $\frac{1}{2}$ " diam. ...	"	4	154b " left-hand "	6	
26a Pinion Wheels, $\frac{1}{2}$ " diam., $\frac{1}{4}$ " wide ...	"	6	156 Pointers, 2 $\frac{1}{2}$ " overall, with boss each	4	
30a Bevel Gears, $\frac{1}{2}$ " 16 teeth ...	"	6	†157 Fans, 2" diam. ...	4	
30c " " 1 $\frac{1}{2}$ " 48 teeth ...	1	6	†158a Signal Arms, Home ...	5	
50a Eye Pieces, with boss ...	"	4	†158b " Distant ...	5	
62b Double Arm Cranks ...	"	3	159 Circular Saws ...	1	0
90a 2 $\frac{1}{2}$ " Curved Strips, 1 $\frac{1}{4}$ " radius ...	"	1	†162 Boiler, complete with ends ...	1	0
*116 Fork Pieces, Large ...	"	3	†163 Sleeve Pieces ...	pair	6
*116a " Small ...	"	3	†164 Chimney Adaptors ...	each	2
†138 Ship's Funnels ...	"	3	165 Swivel Bearings ...	"	6
†138a " Cunard Type ...	"	9	166 End Bearings ...	"	3
142a Dunlop Tyre, 2" int. diam. ...	"	4	†167 Geared Roller Bearings ...	20	0
142b " 3" int. diam. ...	"	6	†167a Roller Race, geared, 192 teeth ...	4	6
†150 Crane Grabs ...	"	7	†167b Ring Frames for Rollers ...	3	0
†151 Pulley Blocks, Single Sheave ...	"	8	167c Pinions for Roller Bearings 16 teeth ...	1	0
†152 " " Two Sheave ...	"	9	†168 Ball Bearings, 4" diam. ...	3	0
†153 " " Three Sheave ...	1	0	†169 Digger Buckets ...	2	0

* These parts are available with nickel finish only.
 † These parts are available with enamel finish only.

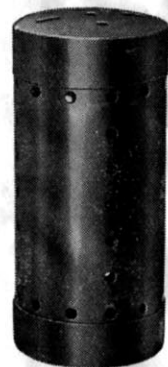

No. 162



No. 150



No. 138a



No. 20b



No. 159

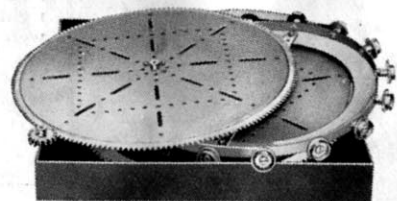

No. 167



No. 89a

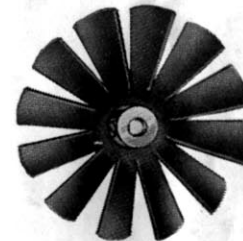

No. 157



No. 168

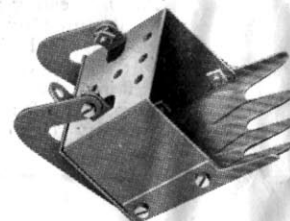

No. 169

Uses for the New Parts

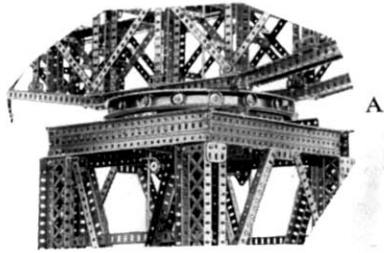

A



B

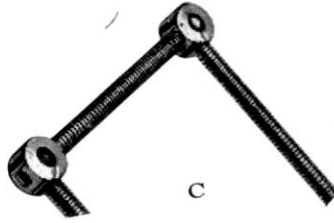

C

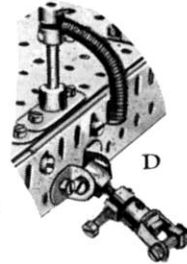

D

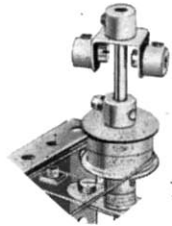

E

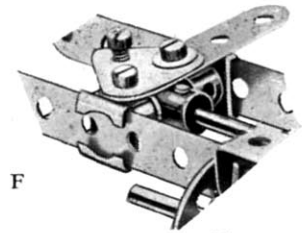

F

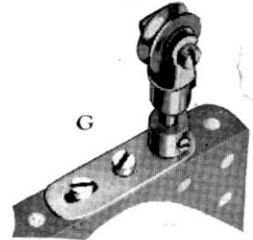

G

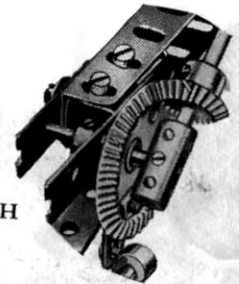

H

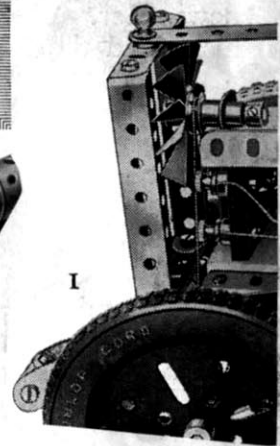

I



P

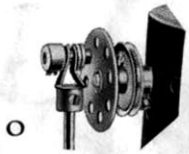

O

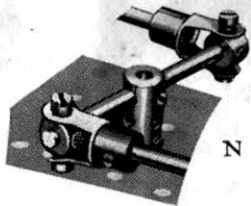

N

Here are some examples of the uses of the new Meccano parts. Each example will probably suggest innumerable other ways in which the particular part may be employed.

- (A) The Geared Roller Bearing (part No. 167) facilitates the construction of large models of the swivelling type. This illustration shows the unit used as a swivelling base for the boom of the Giant Block-setting Crane.
- (B) The centre collar or "spider" of the Universal Joint or Swivel Bearing may be used, in conjunction with four Threaded Pins, to form a hand wheel. (C) It is also useful for joining Rods when constructing handrails, etc.
- (D) No. 62b, Double Arm Crank, used as a support for a Meccano Rod. In all cases where it is necessary to connect a Rod to a Plate this part can be employed with advantage. It may be used also to reinforce journal bearings.
- (E) Two $\frac{3}{4}$ " Flanged Wheels butted together form an efficient belt pulley.
- (F) The Eye Piece with boss is specially designed to slide freely on a Meccano Strip. This illustration shows how it may be used as a crosshead guide shoe in models of steam engines, etc.
- (G) No. 116a, Small Fork Piece, used as a support for a $\frac{1}{2}$ " Pulley.
- (H) Nos. 30a and 30c, $\frac{1}{2}$ " and $1\frac{1}{2}$ " Bevel Gears, used as part of the steering mechanism of a motor chassis.
- (I) No. 157, Fan, 2" diam., used as a radiator cooling fan in the Meccano Chassis.
- (J) No. 166, End Bearing used as a crosshead to connect a piston rod to the connecting rod.
- (K) Another use for No. 50a, Eye Piece. Here it serves as a connection between a rocking lever and a Bush Wheel. As the latter rotates the Eye Piece slides to and fro, imparting a varying movement to the lever.
- (L) Two $\frac{3}{4}$ " Flanged Wheels and a Sleeve Piece form a realistic cylinder.
- (M) Channel Bearing attached to side of Motor to form bearings for the reduction gearing.
- (N) Two Swivel Bearings used to convert a thrust on a sliding lever to a pull on another lever.
- (O) End Bearing used to attach the connecting rod of a steam engine to the crank pin.
- (P) A convenient handle formed from a new style Collar and two Threaded Pins.

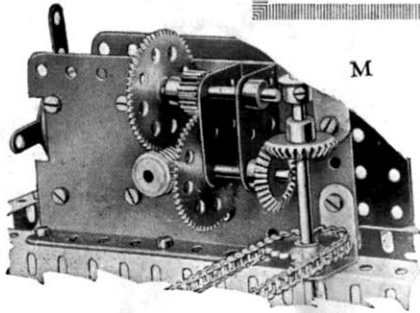

M

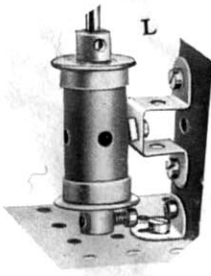

L

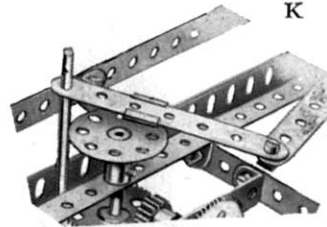

K

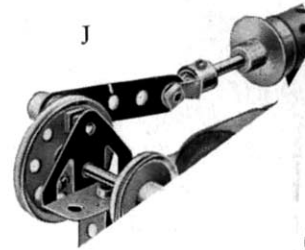

J

MECCANO



MAGAZINE

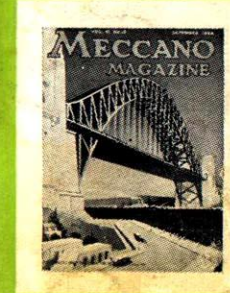

Price 6d.

Price 6d.

A Fine Engineering Monthly for Boys

The "Meccano Magazine" is the Meccano boy's newspaper. He reads it regularly and corresponds with his friend the Editor when he feels inclined.

The Magazine tells him of the latest Meccano models ; what Meccano Clubs are doing ; how to correspond with other Meccano boys ; the Competitions that are running. It contains splendid articles on such subjects as Railways, Famous Engineers and Inventors, Electricity, Bridges, Cranes, Wonderful Machinery, Aeroplanes, Latest Patents, Radio, Stamps, Photography, Books and other topics of interest to boys, including suggestions for new Meccano

parts and correspondence columns in which the Editor replies to his readers' enquiries. The publishing date is the 1st of each month.

Write to the Editor, "Meccano Magazine," Old Swan, Liverpool, enclosing 6d. in stamps. He will then forward a specimen copy of the "M.M.," post free. If you wish to become a regular subscriber the rates are 4/- for six issues or 8/- for twelve issues, post free.

If you prefer to do so, you may order the Magazine from your Meccano dealer or from any newsagent or bookstall, price 6d. *Place a standing order to-day.*

Meccano Limited

Old Swan

Liverpool