

MECCANO

HORNBY'S ORIGINAL SYSTEM—FIRST PATENTED IN 1901

STANDARD MECHANISMS

IMPORTANT
MECHANICAL
MOVEMENTS
CONSTRUCTED
AND
DEMONSTRATED
WITH
MECCANO

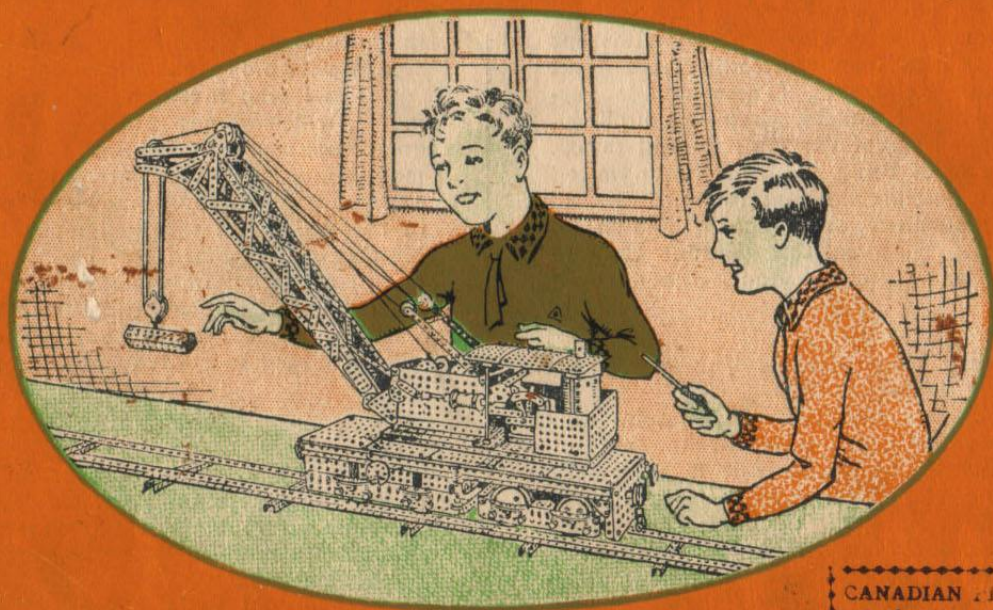

GEARS
CLUTCHES
DRIVE-CHANGES
BELTS
PULLEYS
LEVERS
BRAKES
SCREW-GEARING
ETC.

Price 1/-

CANADIAN PRICE
35 cents

Copyright by MECCANO LTD., LIVERPOOL, throughout the World

Model-Building REAL ENGINEERING



with MECCANO IN MINIATURE

MECCANO is based on a standard system of equidistant holes spaced half an inch apart and comprises a great number of mechanical elements. These include Perforated Strips, Plates, Angle Brackets, Cranks, Couplings, Pulley Wheels, and Gear Wheels of various sizes and ratios. These elements are capable of being used in an unlimited number of ways, making possible the construction in model form of almost any movement or structure known to Mechanics or Engineering. They do this without the aid of elaborate machines and precision tools that would otherwise be necessary.

Inventing New Models

Model-building with Meccano is really fascinating. As long as one is occupied by reproducing the hundreds of models shown in the Instruction Manuals it is extremely simple and easy, and no undue brain work is necessary. No Meccano boy is content to build only the models illustrated in the Manuals, however, for every thinking boy is keen to invent and likes to build models from his own ideas.

With this in mind, and to assist boys to base their models on correct engineering practice, we have collected and classified a number of Meccano movements that have to a certain extent become standardised. That is to say, these movements may be applied to more than one model—

in most cases without any alteration, but in some few instances with only slight alterations, to the standard movement.

Those who invent with Meccano will find these movements, which we now publish as "Standard Mechanisms," of great assistance in helping to perfect their models. The movements have been arrived at by careful thought and experiment, and some knowledge of the principles involved in many of them will well repay the study of any boy interested in engineering. The various devices have been arranged so that immediate reference may be made to any particular motion that it is desired to incorporate in a model. There is no finality in examples of this kind, and others will be added in subsequent editions of this book.

The Value of Meccano

While the greater proportion of boys—or even men—in every generation possess a desire to know just *why* the "wheels go round," it has never been possible, prior to the introduction of Meccano, for the unskilled to make mechanical models.

When you build models with Meccano you use real engineering parts in miniature, for they act in a manner precisely similar to the corresponding elements in actual practice. This means that with Meccano you can accomplish more than with any other system of model construction.

Other systems attempt to attain the same object by different methods, and avail themselves of constructive elements that are not based on correct engineering principles. It is important to realise this, for if you commence with badly-designed parts you can only build a very limited number of models. Even these will be constructed incorrectly and will give you faulty ideas of the principles of Engineering.

For these reasons Meccano becomes something more than a toy—it is an educational medium of very real value. Professors of Engineering, bridge-building experts, draughtsmen, and others who are in a position to judge, have from time to time pronounced on the Meccano system. All have declared it to be conceived on sound lines and based on true engineering principles.

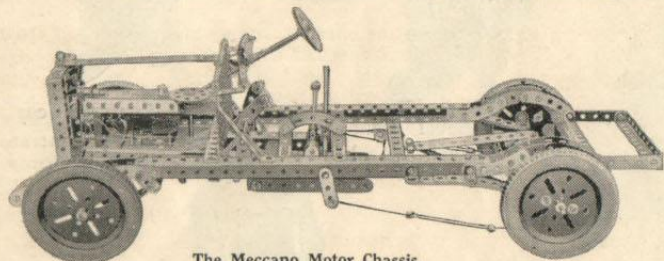

The Meccano Motor Chassis complete with Gear Box, Clutch, Differential and Ackermann Steering

We have numerous records in our files of large engineering firms who employ Meccano for designing movements or engineering structures that they are about to build. Famous inventors use it for experimenting and for working out ideas, while in school and colleges it is used to demonstrate all branches of mechanics.

Meccano Models are real Models

There is no limit to the number of models that may be built with Meccano, and all are real working structures. The Meccano Clock is a real clock—it keeps accurate time. The Meccano Loom is a real loom, and it weaves beautiful material for hat-bands or neck-ties. The Meccano Motor Chassis—with Ackermann steering gear, gear-box, clutch, and differential—so closely resembles a real motor car that it is used for teaching students at numerous Schools of Motoring.

It is the same with all other Meccano models—they are all accurate reproductions of the real thing, and they all work because they are based on correct engineering principles.

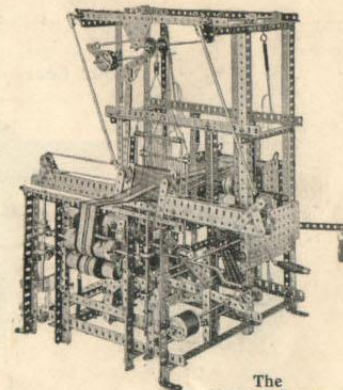

The Meccano Loom

Meccano Standard Mechanisms

CONTENTS

For easy reference purposes, the various mechanisms have been grouped under the following SECTIONS:—

	Page		Page
I. Gear Ratios : Methods of Speed Reduction and Acceleration	3	VIII. Steering Gear	29
II. Belt and Rope Mechanism	4	IX. Screw Mechanism	32
III. Pulleys and Pulley Blocks	5	X. Overhead Trolleys and Trucks for Gantries, etc.	35
IV. Levers	8	XI. Traversing Mechanism	37
V. Clutches, Reversing and Drive-Changing Mechanism	9	XII. Grabs, Buckets and Dredging Apparatus	40
VI. Brakes and Governing Appliances	19	XIII. Miscellaneous Appliances	41
VII. Roller and Ball Bearings, etc.	24	Index	48

Section I. GEAR RATIOS.

Methods of Speed Reduction and Acceleration

Spur Gear

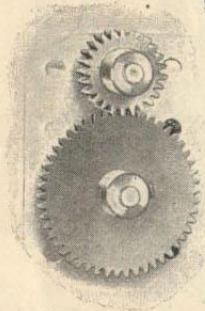

S.M. 1— $\frac{3}{4}$ " Pinion and 50-teeth Gear Wheel. Ratio, 2 : 1.

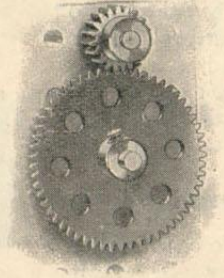

S.M. 2— $\frac{1}{2}$ " Pinion and 57-teeth Gear Wheel. Ratio, 3 : 1.

Further examples of Gear Ratios :

$\frac{1}{2}$ " Pinion and $3\frac{1}{2}$ " Gear Wheel. Ratio, 7 : 1.
Ratios of 1 : 1 may be obtained by using two 1" Gear Wheels or two $\frac{1}{2}$ " Pinions.

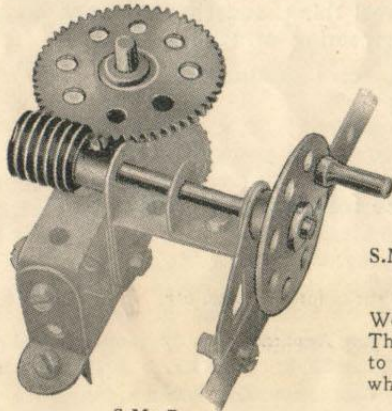

S.M. 5

S.M. 5—Worm Gearing. Worm Wheel and 57-teeth Gear Wheel. Ratio, 57 : 1.

Worm Wheel and $\frac{1}{2}$ " Pinion. Ratio, 19 : 1.
The number of revolutions of a Worm Wheel to one revolution of the Gear Wheel or Pinion which it drives corresponds with the number of teeth on the driven wheel.

S.M. 6

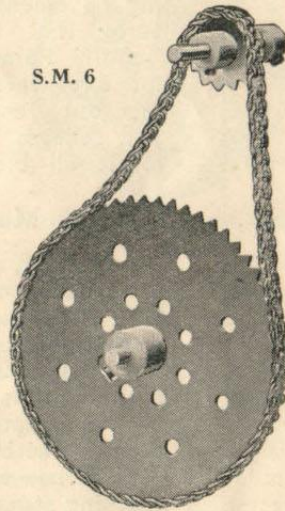

S.M. 6—Chain Gear
 $\frac{3}{4}$ " and 3" diam. Sprocket Wheels. Ratio, 4 : 1.
1" and 2" diam. Sprocket Wheels. Ratio, 2 : 1.
 $\frac{3}{4}$ " and $1\frac{1}{2}$ " diam. Sprocket Wheels. Ratio, 2 : 1. etc., etc.
Ratios of 1 : 1 may be obtained by gearing any two Sprocket Wheels of like diameter.

For Shafts at Right Angles

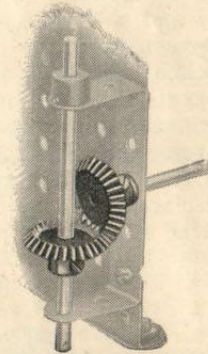

S.M. 3—Bevel Gear
Two $\frac{7}{8}$ " Bevel Wheels: Ratio, 1 : 1.

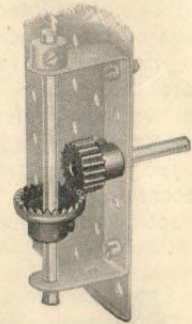

S.M. 4—Contrate Gear
 $\frac{1}{2}$ " Pinion and $\frac{3}{4}$ " Contrate Wheel. Ratio, Approx. $1\frac{1}{2}$: 1.

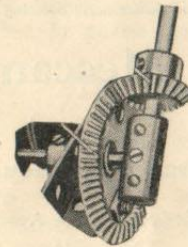

S.M. 7—Bevel Gear
 $\frac{1}{2}$ " and $1\frac{1}{2}$ " Bevel Wheels: Ratio, 3 : 1.

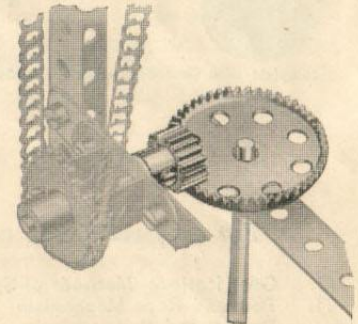

S.M. 8—Contrate Gear
 $\frac{1}{2}$ " Pinion and $1\frac{1}{2}$ " Contrate Wheel. Ratio, approx. $2\frac{2}{3}$: 1.
 $\frac{3}{4}$ " Pinion and $1\frac{1}{2}$ " Contrate Wheel. Ratio, 2 : 1.

Section II. BELT AND ROPE MECHANISM

In Meccano models, cords usually take the place of belts for this method of power transmission. Miniature belting may be made, however, from strips of canvas, indiarubber, etc., in which case Flanged Wheels should be used, either singly or in pairs (as in S.M.18), instead of grooved pulleys. The Meccano Spring Cord also forms an excellent means of connection between pulleys.

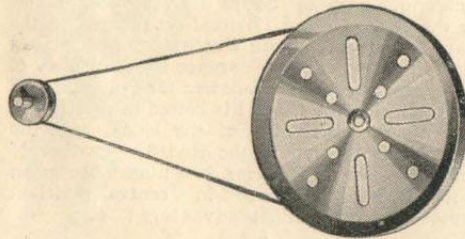

S.M. 15—Open Belt Gear. A wide range of speeds may be procured with Meccano Pulleys and belt gear. This detail illustrates the $\frac{1}{2}$ " and 3" Pulleys, giving great difference in speed between the two shafts.

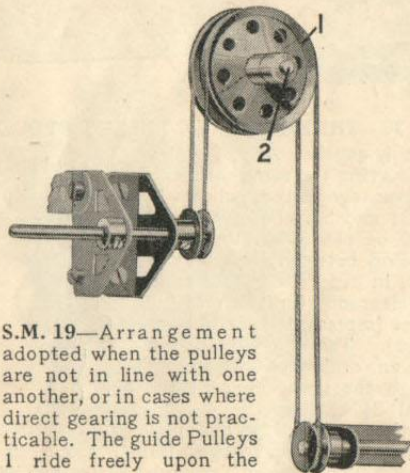

S.M. 19—Arrangement adopted when the pulleys are not in line with one another, or in cases where direct gearing is not practicable. The guide Pulleys 1 ride freely upon the axle 2.

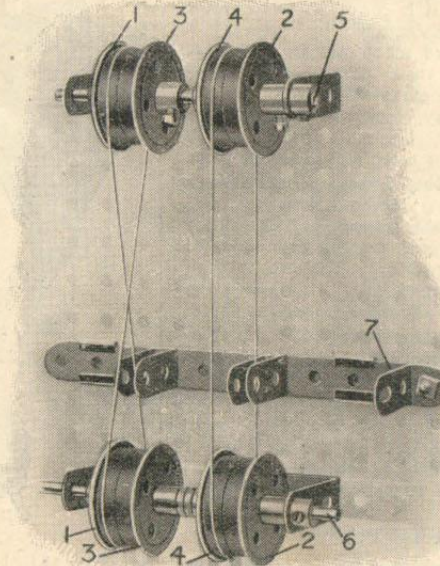

S.M. 18—Belt Reversing Gear. Two pairs of Flanged Wheels, 1 and 2, are fixed, and two pairs, 3 and 4, are loose on a driving shaft 5 and a driven shaft 6. The wheels 1 are connected by a crossed belt, thereby reversing the motion of the driven shaft 6 (as in S.M.17), while the wheels 4 are connected by an open belt. The operation of a lever 7 brings one of the belts on to a pair of fixed pulleys, at the same time throwing the other on to a loose pair, or vice versa, thereby reversing the action of the driven shaft 6.

S.M. 18a—Belt Clutch. In the above illustration, the pulleys 4 and 2 also demonstrate the principle of a belt clutch. The driven shaft 6 may be thrown into gear with the shaft 5 by moving the belt on to the fixed pair of wheels 2, and by reversing the operation it may be thrown out of gear again without stopping the driving shaft 5.

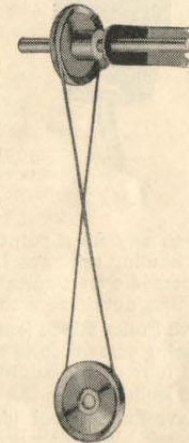

S.M. 16—Driving two shafts at right-angles to one another.



S.M. 17—Method of reversing motion of driven shaft by means of a crossed belt.

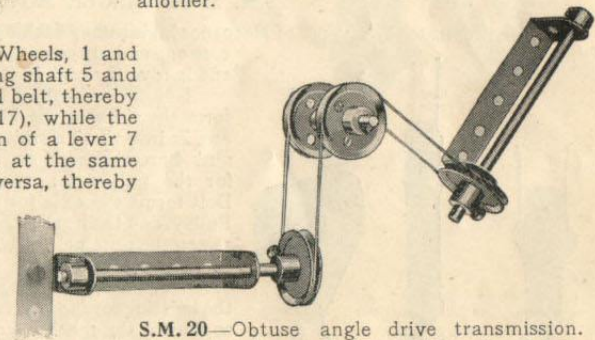

S.M. 20—Obtuse angle drive transmission. May also be used for right-angle drives, instead of bevel gears.

Section III. PULLEYS AND PULLEY BLOCKS

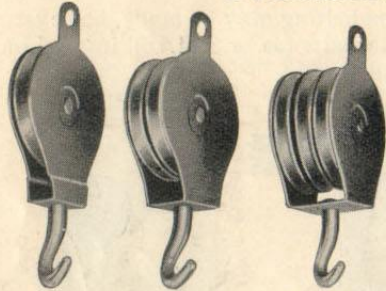

S.M. 29

S.M. 30

S.M. 31

S.M. 29-31—PULLEY BLOCKS

We illustrate the three Standard Meccano Pulley Blocks. These are suitable for use in cranes and other models where it is required to obtain a mechanical advantage by means of pulley and cord mechanisms. In large models where these parts would prove too light, or in cases where they are not available, pulley blocks may be built up from ordinary Meccano parts, as is shown by other examples on this page.

S.M. 29—Single Sheave Pulley Block (part No. 151).

If the hoisting cord is passed round the sheave of this pulley block and then secured to any fixed point, a theoretical mechanical advantage of two will be obtained by hauling upon the free end. Alternatively, the end, instead of being fixed, may be passed over a suitable pulley, returned, and attached to the lug of the Pulley Block, thus obtaining a theoretical mechanical advantage of three.

S.M. 30—Two Sheave Pulley Block (part No. 152). When suspended by two loops of cord, each loop being passed round one of the sheaves, this Pulley Block gives a theoretical mechanical advantage of four. If in addition the end of one of the loops is brought down and attached to the lug of the Pulley Block, the theoretical mechanical advantage is increased to five.

S.M. 31—Three Sheave Pulley Block (part No. 153). This part is useful where it is required to raise a fairly heavy load. When suspended by three loops of cord, each loop being passed round one of the sheaves, it provides a theoretical mechanical advantage of six, or if the end of one of the loops is brought down to the lug, the theoretical mechanical advantage is seven.

S.M. 33-35—SINGLE MOVABLE PULLEYS

We illustrate three types of Meccano single pulley tackle which may be used in place of Part No. 151. In each case one end of the cord is secured to the tail of a standing block and the other end is rove through its pulley and leads down as the running or hauling-end.

S.M. 35 is shown dismantled in S.M. 35a. Two Flat Trunnions 1 and 1a form the sides of the block, which is built up by inserting three $\frac{3}{8}$ " Bolts 2 and 2a into the Trunnion 1 and securing them by nuts 3. Three further nuts 4 are threaded on to the bolts 2 and adjusted to provide clearance for the pulley 5; the Trunnion 1a is then bolted into position. A $\frac{3}{8}$ " Bolt forms the axle for the $\frac{1}{2}$ " Pulley, and the hook is held between the nuts on the bolt 2a.

In each of these three arrangements, provided that the hoisting cords are arranged as shown, the mechanical advantage is two, that is, a 10 lb. weight should (theoretically) be lifted with a force of 5 lb.

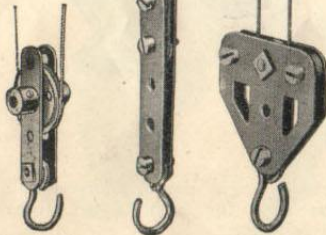

S.M. 33

S.M. 34

S.M. 35

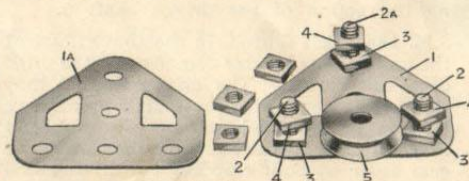

S.M. 35a

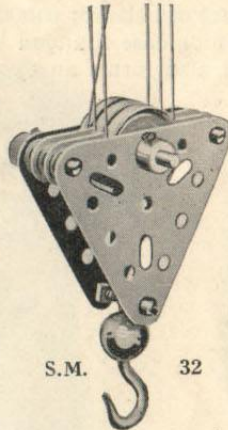

S.M.

32

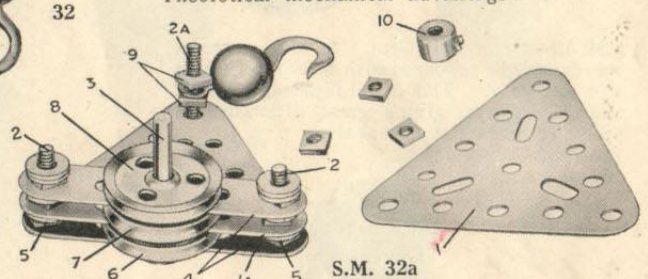

S.M. 32a

S.M. 32—THREE SHEAVE PULLEY BLOCK

This block is constructed from two $2\frac{1}{2}$ " Triangular Plates 1 and 1a held together by $\frac{3}{8}$ " Bolts 2. Three 1" loose Pulleys are pivoted on the Rod 3, which is journalled through the centre holes of the Plates and fitted with Collars on each end. Two $2\frac{1}{2}$ " Strips 4 are used as guides for the Cord. The $\frac{3}{8}$ " Bolts 2 are secured to the Plate 1a by nuts 5; two Washers are next placed on the bolts to ensure clearance for the Pulley 6. The same procedure is followed for Pulleys 7 and 8, after which the Plate 1 is bolted in position to form the opposite side of the block, and the Collar 10 is secured to the Rod 3. Another $\frac{3}{8}$ " Bolt 2a is inserted having two nuts 9, between which the hook is clamped in a central position. Theoretical mechanical advantage: 6.

S.M. 36—THREE SHEAVE PULLEY BLOCK

This is another type of pulley block having the same mechanical advantage as those shown in S.M. 31 and 32. Four Washers should be placed on the lower Axle Rod between each pair of Strips, in order to obtain sufficient clearance for the rotating sheaves (represented by 1" loose Pulleys). The Hook is placed upon an ordinary bolt passed through the lower ends of the central $2\frac{1}{2}$ " Strips.

Further examples of single and double sheave pulley blocks built up from 1" loose Pulleys journalled between Triangular Plates, will be found in S.M. Nos. 204 and 205 (see page 36).



Section III. Pulleys and Pulley Blocks—(continued)

S.M. 38—MOVABLE PULLEY BLOCK FOR CRANE

A hoisting-cord is led over one of the pulleys in the jib-head, around the sheave of a movable pulley block, over a second jib pulley, and back again to the movable pulley block, where it is secured. In this way a theoretical mechanical advantage of three is obtained, for the movable pulley is supported by three cords. The 1" pulley forming the sheave of the pulley block is mounted on a 1" Rod journalled on two $2\frac{1}{2}$ " Strips.

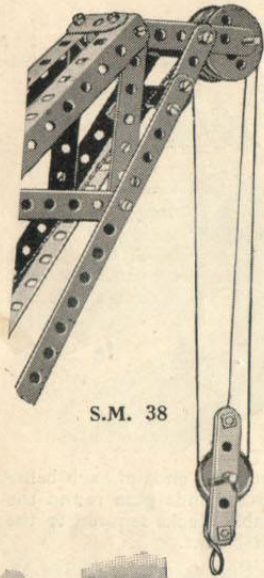

S.M. 38

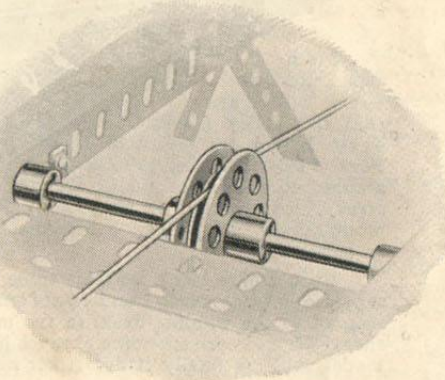

S.M. 39

S.M. 39—GUIDE PULLEY

This is constructed by clamping a 1 in. loose Pulley between two Bush Wheels. The deep groove so obtained is a great improvement, especially when used in models where the cord is liable to be jerked off an ordinary pulley.

**S.M. 39a—
DEEP-GROOVED PULLEY**

A larger deep-grooved pulley may be constructed by bolting a Wheel Flange between two Face Plates. With this arrangement the cord is led round the periphery of the Wheel Flange and is held in place by the protruding edges of the Face Plates. A two-sheaved deep-grooved pulley is shown in S.M. 205.

S.M. 41—VARIABLE PULLEY BLOCK

A 1 in. Pulley 4, from which a load hook 5 is suspended, is carried in two Cranks 6 connected to a $3\frac{1}{2}$ in. Rod 7 slidable in two Double Brackets 8. The Rod 7 is supported by the Sprocket Chain 9 to which it is connected by a Collar and Set Screw.

By attaching the other end of the chain to some resistance, such as a Meccano Spring, the weight of a load on the Hook 5 may be calculated by noting the distance through which the Chain is pulled. The movement of the Chain may be employed to operate a suitable indicator, such as a pointer with graduated dial similar to that provided in Model No. 6.24, Automatic Weighing Crane.

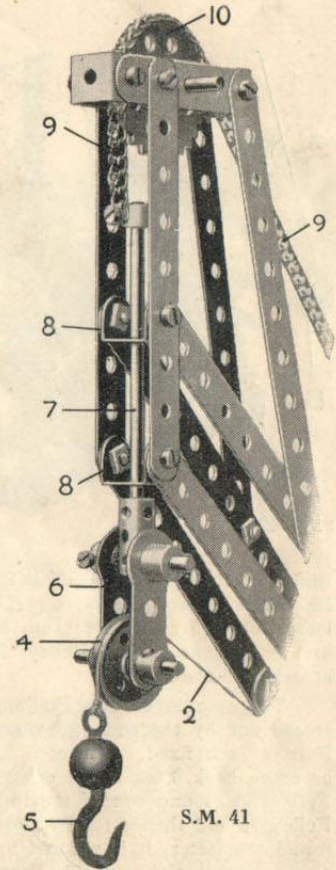

S.M. 41

S.M. 40—GUIDE PULLEYS

Hoisting-cords may be directed to a jib-head by guide pulleys 9 constructed by butting two Flanged Wheels together. These are mounted on shafts 10 journalled in a Corner Bracket 11 and in two holes of a 3 in. Sprocket Wheel 7.

As the jib 5 swings about its pivot 8 the cords are retained in line with the 1" pulleys shown by one or other of the guides 9.

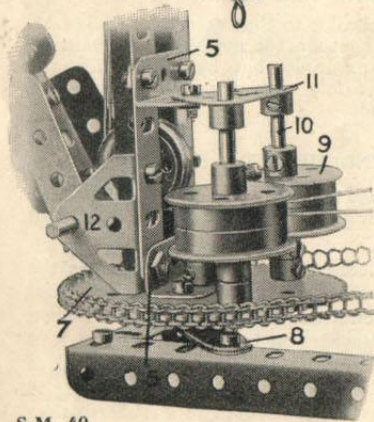

S.M. 40

Section III. Pulleys and Pulley Blocks—(continued)

S.M. 42—AUTOMATIC REVERSING HOIST

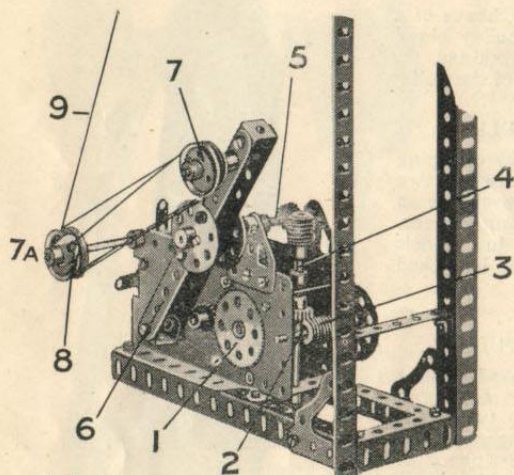

S.M. 42

Pinion on the $3\frac{1}{2}$ " Rod 5. This Rod 5 carries a rotating arm 6, built up from $5\frac{1}{2}$ " Strips secured rigidly to the Rod 5 by means of Bush Wheels. Two 1" loose Pulleys 7 are free to turn on a 2" Rod journalled in the arm 6 and two similar Pulleys 7a are mounted on a $4\frac{1}{2}$ " Rod attached to the Motor.

The spindle of the Pulleys 7 follows the circular path traced out by the end of the arm 6, while the spindle of the Pulleys 7a is fixed. The cord 9, which is attached to the lift or crane hook, etc., is led down and over one of the 1" loose Pulleys 7a, round one of the Pulleys 7, back to the remaining Pulley 7a and thence to the second 1" Pulley 7. After passing round the latter, it is secured to the Flat Bracket 8. As the arm 6 rotates, the cord 9 is alternately drawn in and paid out, thus working the lift cage or crane hook up and down.

The extent of the travel of the cage or hook may be varied considerably by altering the length of the arm 6 carrying the Pulleys 7, adding to the length to increase the travel and vice versa.

This is a simple device by means of which a lift, crane, or similar model may be made to work for an indefinite period without attention.

The drive is taken from the Motor armature via a $\frac{1}{2}$ " Pinion engaging with the 57-teeth Gear Wheel 1, and a $\frac{1}{2}$ " Pinion on the opposite end of the Rod carrying the Gear 1 meshes with another 57-teeth Gear on the 2" Rod 2. On the Rod 2 is a Worm 3 meshing with a $\frac{1}{2}$ " Pinion secured to a vertical 3" Rod 4, which carries at its upper extremity a second Worm meshing with a $\frac{1}{2}$ "

S.M. 43—PULLEY BLOCKS PIVOTED TO JIB-HEAD

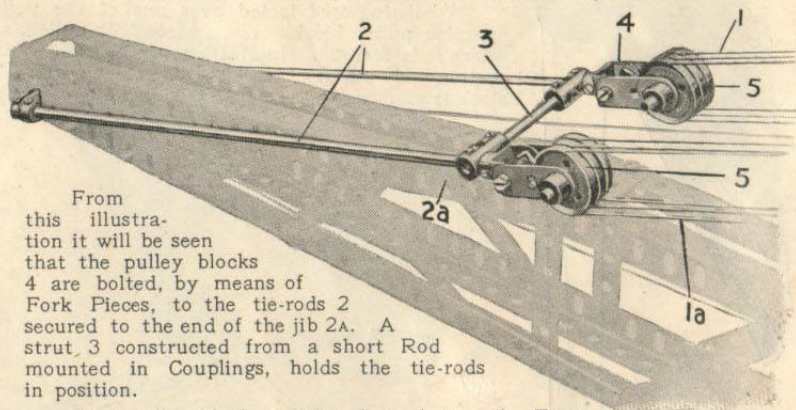

From this illustration it will be seen that the pulley blocks 4 are bolted, by means of Fork Pieces, to the tie-rods 2 secured to the end of the jib 2a. A strut 3 constructed from a short Rod mounted in Couplings, holds the tie-rods in position.

Each pulley block contains three sheaves 5. Two separate hoisting cords 1 and 1a are employed, the running ends of each being secured to the winding-drum in the model. The other ends pass round the sheaves 5 and corresponding sheaves in the immovable blocks secured to the model, and are finally tied to their respective fixed blocks.

The arrangement of the cords 1, 1a is similar to that described in S.M.31. Because both running ends are hauled in together, the mechanical advantage also is the same as in that example, but by duplicating the mechanism we are able to safely use increased power and consequently raise greater loads.

S.M. 44—SWIVELLING JIB-HEAD PULLEY

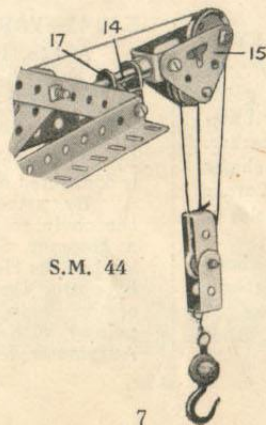

S.M. 44

The jib-head Pulley shown in S.M. 44 is capable of turning round on a swivel, thus enabling the hoisting block to be hauled in at any angle to the jib.

The supports for the 1" loose Pulley over which passes the hoisting cord, consist of two Corner Brackets 15 spaced apart by a Large Fork Piece, additional width being obtained between the Brackets 15 by slipping Washers on to the bolts. The Rod 14, to which the Large Fork Piece is attached, is journalled at the top of the jib in a Double Bracket 17, whilst its lower end passes through a Cranked Bent Strip secured to a 2" Strip that is bolted across the jib Angle Girders.

Section IV. LEVERS

S.M. 52-54—TYPES OF HAND LEVER

S.M. 52. The Rod 1, forming the lever, carries two Couplings 2 and pivots about a Rod 3. A Spring 4 is connected to a 2" Rod 5 mounted in the Couplings 2, whilst a second Spring 6 is carried on the lower end of the lever 1. One Spring slides up its respective Rod when the lever slopes towards it, whilst the other slides downward. The uppermost Spring, in consequence of its increased leverage, holds the lever in position until it is actually pulled over to its opposite position by hand, when the springs change places as described. A Bush Wheel 7 carrying two bolts 8 prevents the lever springing too far in either direction.

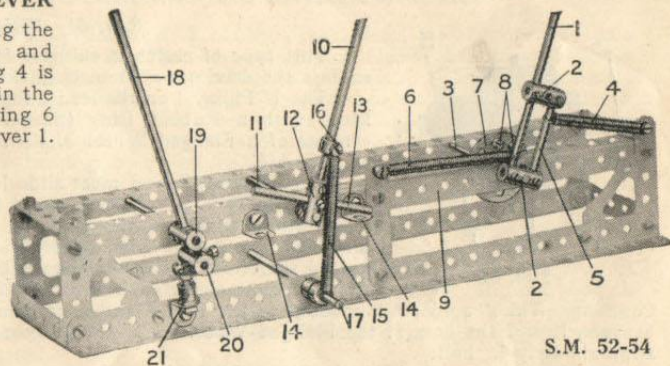

S.M. 52-54

S.M. 53. The lever 10 pivots about a Rod 11, and a 2½" Rod 13 secured in the Coupling 12 is arranged to strike one or other of the stops 14. A Spring 15 is fixed to a Collar 16 on the lever 10 while its lower end is attached to a Rod 17. If the lever is placed in a vertical position the pull of the Spring is neutral, but as soon as it passes the central position, the Spring pulls the lever over until the Rod 13 strikes one of the stops.

S.M. 54. The lever 18 passes through a Coupling 19 and carries a second Coupling 20. The latter presses upon a Spring Buffer 21, and carries two 7/32" Bolts on opposite sides. The thrust of the Buffer pushes the lever to one side or the other as soon as it passes the central or vertical position. The bolts mounted in the lower Coupling act as stops to prevent the lever moving too far.

S.M. 51—LEVERS IN PLATFORM SCALES

In S.M. 51 a series of levers of the third order are arranged so that a very slight movement of a heavy load is caused to move a balance arm through a considerably greater distance, with the result that a small weight applied to the balance arm is sufficient to counterbalance the heavy load.

In each of the smaller levers, the fulcrum is at E while the weight or load rests upon the centre. When the load is applied the movement of the end F operates the second pair of levers. The latter pivot about the points B and are connected at their other ends to the balance arm by means of a length of Sprocket Chain A. In these levers the load is brought to bear upon the points C, D.

Excellent illustrations of the use of the lever as a means of transmitting power will be found in the Meccano Bale Press (model No. 4.1 in the Instruction Manual), and the Punching Machine (No. 1.56). In each of these models a slight pressure on one point is caused to bear with greatly increased force on another.

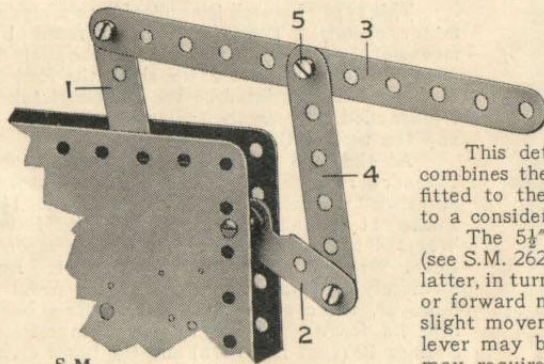

S.M.
55

S.M. 55—UNIVERSAL LEVER FOR CLOCKWORK MOTOR

This detail consists essentially of a single lever 3 which combines the functions of both the reversing and brake levers fitted to the Clockwork Motor, and so simplifies the control to a considerable extent.

The 5½" Strip forming the lever 3 is attached pivotally (see S.M. 262) to the reversing lever 1, and to a 3" Strip 4. The latter, in turn, is pivoted to the brake lever 2. A short backward or forward movement of the lever 3 effects the reverse, and a slight movement up or down stops or starts the Motor. The lever may be lengthened in either direction as circumstances may require, in order to permit of the distant control of the mechanism.

Section V.

CLUTCHES, REVERSING & DRIVE-CHANGING MECHANISM

S.M. 61—FRICTION CLUTCH

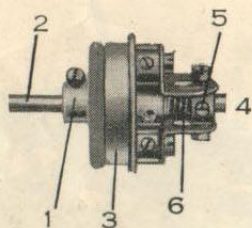

S.M. 61

Coupling. This "spider" is secured to the Rod 4 and a portion of a Compression Spring 6 is inserted between it and the boss of the Flanged Wheel. For this purpose it will be necessary to cut the spring approximately in half.

The Spring normally holds the Flanged Wheel in engagement with the Rubber Ring on the Pulley 1 but the Flanged Wheel can be forced back on the Rod 4 to an extent just sufficient to throw it out of gear with the clutch member 1. The end of Rod 2 should be allowed to just enter the boss of the Wheel 3, in order to obtain additional support.

The clutch withdrawal mechanism should consist of suitable arms or "claws" resting on the flange of the Wheel 3 and engaging its rim, so that on operation of a convenient hand or foot lever, the Wheel 3 may be forced back against the spring.

S.M. 62—GEAR CLUTCH

This type of clutch is applicable to a model motor chassis. The clutch is operated by means of the foot pedal 6 pivoted on the shaft 5, which on being pressed down, slides the Rod 2, to which it is connected by the Double Bracket 7 journalled between the Collar and set screw 8 and the boss of the Bush Wheel 9.

As the Rod 2 slides in its bearings the Threaded Pins 10 bolted to the Bush Wheel 9 are thrust further into the holes of the $1\frac{1}{2}$ " Pulley 11, and at the same time the Bevel Wheel 4 is drawn out of gear with a second Bevel Wheel 3 on the driving shaft 1. Immediately the pressure relaxes on the pedal 6 however, the counter shaft 2 is pushed back into its former position by the Compression Springs 12 (Part No. 120B) and the bevel drive 3 and 4 is again brought into gear.

S.M. 62

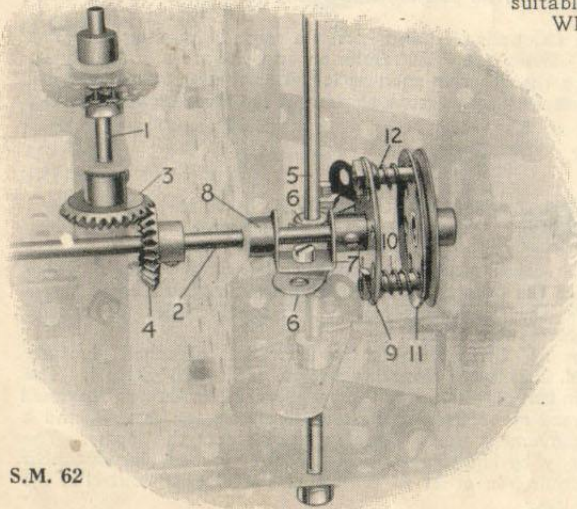

S.M. 63—DOG CLUTCH

This detail provides a typical illustration of Dog Clutch mechanism. The clutch member 1, carried on a short Rod which is slidable in its bearings, is brought into engagement with the clutch jaws mounted on a further Rod 2, by means of a lever 3. The latter is pivoted (by bolt and lock-nuts) to an Angle Bracket at 5, and also to a Single Bent Strip 4 loosely held between the clutch segment 1 and a Collar and set screw.

A considerable improvement is effected by connecting a Spring to the lever 3, in such a manner that it normally holds the clutch members together. This Spring re-engages the shaft 2 immediately pressure is relaxed on the lever 3.

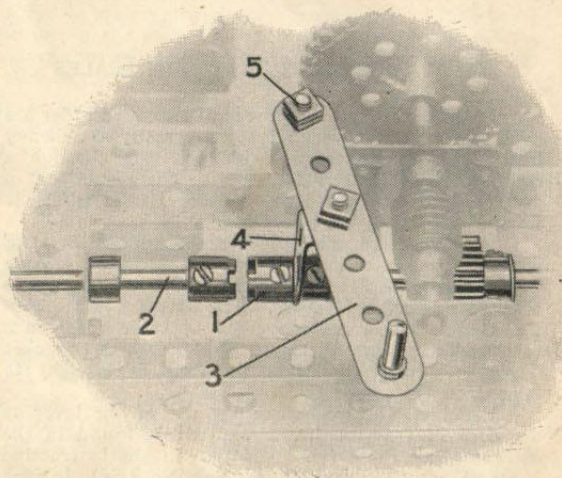

S.M. 63

Section V. Clutches, Reversing and Drive-Changing Mechanism—(continued)

S.M. 65—DRIVE-CHANGING AND REVERSING GEAR

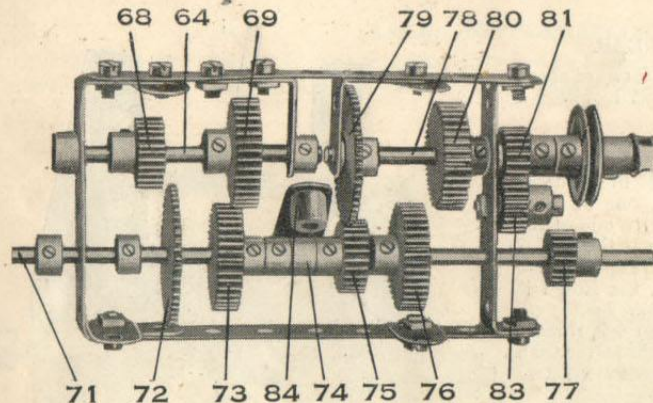

S.M. 64

S.M. 64—DRIVE-CHANGING AND REVERSING GEAR

S.M. 64 illustrates a compact example of a gear-box providing three speeds forward, neutral, and reverse gears. This type of gear box is particularly adaptable to model automobiles.

The Rod 64 forms the primary driving shaft. It is provided with a $\frac{3}{4}$ " Pinion 68 and a 1" Gear Wheel 69. The countershaft consists of a $6\frac{1}{2}$ " Rod 71 that is slidable in the end Double Angle Strips of the gear box. This Rod carries the following parts: two Collars (acting as stops to limit its sliding movement), a 50-teeth Gear 72, 1" Gear 73, two more Collars, one of which (74) is free on the Rod, $\frac{3}{4}$ " Pinion 75, 1" Gear 76, and $\frac{1}{2}$ " Pinion 77. The driven 3" Rod 78 carries a 50-teeth Gear 79, 1" Gear 80, and $\frac{1}{2}$ " Pinion 81. A Washer should be placed between the $\frac{1}{2}$ " Pinion 81 and the Double Angle Strip. This Pinion is in constant engagement with another $\frac{1}{2}$ " Pinion 83, which is free to turn upon a $\frac{3}{4}$ " Bolt secured to the end Double Angle Strip by two nuts.

An ordinary $7/32$ " Bolt passes through the elongated hole of the Crank 84 and enters the threaded bore of the Collar 74. A nut placed upon it is secured tightly against the Collar in order to prevent its shank touching the Rod 71. The Crank should be connected to any suitable hand lever.

The different speeds are obtained as follows. Assume that the sliding Rod 71 is at the furthest limit of its travel to the left. Then the drive from the engine is led through the following gears: 68, 72, 77, 83, and 81. This constitutes reverse gear, and the speed ratio between the driven shaft 78 and the driving rod 64 is 1 in 2. A slight movement of the gear change lever disengages the Pinion 77 from Pinion 83, and "neutral" gear results, the secondary shaft revolving idly. Further movement of the lever slides the Rod 71 further to the right and causes the following gears to be engaged: 68, 72, 75, and 79. This gives first speed forward, the ratio between shafts 78 and 64 being 1 in 4. Continuing the movement of the lever, the second forward speed is obtained, the drive now being directed via 69, 73, 75, and 79. Ratio: 1 in 2. When the lever is hard over and the Rod 71 at the limit of its travel to the right, the gears in engagement are 69, 73, 76, and 80. This represents top forward speed, with a ratio of 1 in 1.

A Crank 1, secured to the vertical shaft 2, carries a short Rod 3 loosely journalled in a Coupling 4 also secured to the shaft 2. The short Rod 3 protrudes slightly from the lower Collar 5 and enters a hole in the Bush Wheel 6 bolted to the Plate 7. The Rod 2 is loosely journalled through this Bush Wheel 6 and engages, by means of the Pinion and 57-teeth Gear Wheel 8 and 9, a further Rod 10. The latter carries in a Coupling 11 a short Rod 12 which engages between two Collars 13 on an intermediate driving shaft 14. This shaft 14 is thus moved to and fro in its bearings by lifting the Collar 15 and moving the Crank 1 to left or right until the Rod 3, actuated by a small Compression Spring 16 (Meccano Part No. 120B), snaps home into the next hole of the Bush Wheel 6. The central position of the Rod 2 enables the shaft 14 to revolve freely, but the movement of the Rod to the next hole in the Bush Wheel brings the Pinion 17 into gear with another Pinion 18, whilst a move of one hole in the opposite direction brings further Pinions (not shown in the photograph) secured to shaft 14 into engagement with Gear Wheels carried on a further driven shaft (also not shown).

Thus this movement may be utilised (a) to throw the Motor out of gear with—say—the road wheels of a tractor, (b) to drive the same forward at reduced speed, and (c) to reverse the direction of their rotation.

It should be noted that in our illustration a side plate corresponding to that shown at 19 has been removed in order to disclose the mechanism. Normally this plate is bolted to the Girders 20 and 21 and so forms a bearing for the shaft 14.

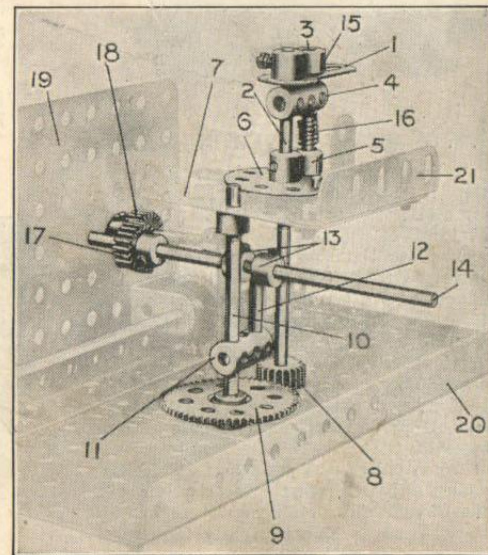

S.M. 65

Section V. Clutches, Reversing and Drive-Changing Mechanism—(continued)

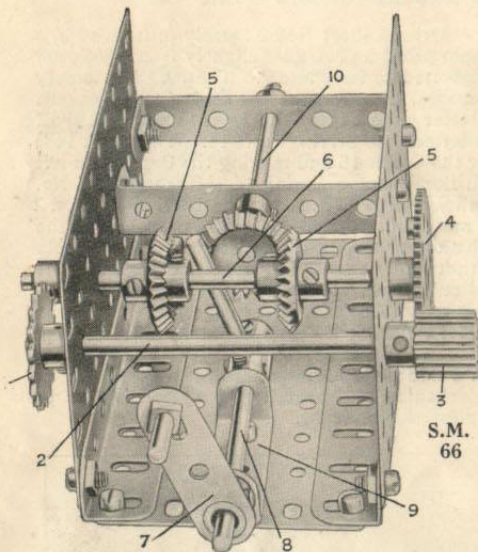

S.M.
66

S.M. 66—BEVEL REVERSING GEAR

The driving power is applied to the 1" Sprocket Wheel 1 and is directed via the $\frac{1}{2}$ " diam. $\frac{1}{2}$ " face Pinion 3 to the Gear Wheel 4 which is secured to the Rod 6 carrying two $\frac{7}{8}$ " Bevel Gears 5. The changing is effected by a lever 7, which is secured to a Rod 8 journaled in a $1\frac{1}{2} \times \frac{1}{2}$ " Double Angle Strip 9. A short vertical Rod secured to the Rod 8 causes the Rod 6 to move longitudinally in its bearings by striking one of the Collars secured against the faces of the Bevels 5. The direction of rotation of the driven Rod 10 is changed by bringing one or other of the Bevels 5 into engagement with the third Bevel, which is rigidly fastened to the Rod 10.

S.M. 67—TWO-SPEED REVERSING GEAR

This mechanism is designed to give a slow forward speed and rapid reverse, or vice versa, and either Rod 1 or Rod 2 may be used as the driving shaft.

The Rod 2 is capable of sliding in its bearings and is controlled by a suitable hand lever 3. This Rod carries two Contrate Wheels 4 and 5, which are $\frac{3}{4}$ " and $1\frac{1}{2}$ " in diameter respectively, and on operation of the lever 3, one of these Contrate Wheels is brought into engagement with one of the two $\frac{1}{2}$ " Pinions secured to the Rod 1. Hence if the Rod 2 is used as the driving shaft and the large Contrate Wheel 5 is thrown into gear with its respective Pinion, the Rod 1 is driven nearly three times as fast as the Rod 2.

Alternatively, if the small Contrate Wheel 4 is thrown into engagement, the Rod 1 revolves only a little faster than the driving Rod, the approximate ratio between the two being $1\frac{1}{2}:1$.

If the sliding Rod 2 is required to remain constantly in gear with toothed wheels on a further driving rod, the necessary adjustment may be obtained by securing upon it a $\frac{1}{2}$ " or $\frac{3}{4}$ " face Pinion and meshing the Pinion with a gear Wheel on the further Rod.

If desired a $\frac{1}{2}$ " diameter $\frac{3}{4}$ " face Pinion can be used in place of the two $\frac{1}{2}$ " Pinions on Rod 1, thus economising in parts.

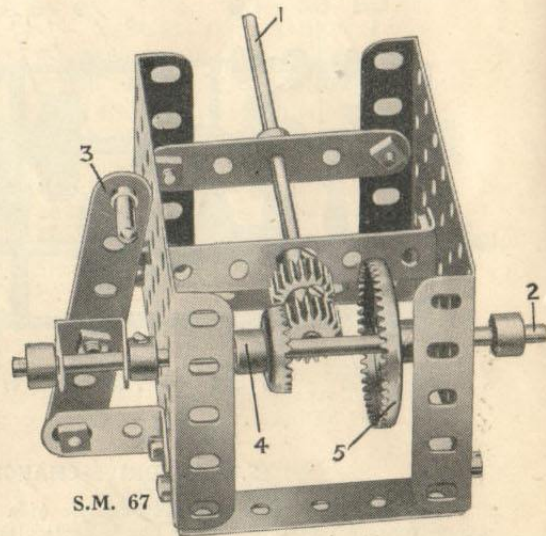

S.M. 67

S.M. 68—REVERSING GEAR

S.M. 68

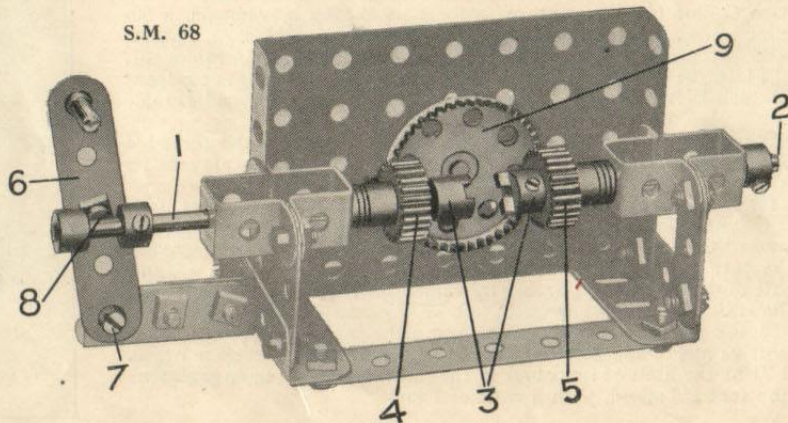

Either of the Rods 1 and 2 may be used as the driving shaft. Each carries at its inner end one segment of a Dog Clutch 3, and one $\frac{3}{4}$ " Pinion 4, 5. The Rod 1 is slidable in its bearings and is controlled by a lever 6 pivotally mounted at 7 and carrying a bolt 8, the head of which engages between two Collars on the shaft 1. In the first position of the lever the $\frac{3}{4}$ " Pinion 4 is caused to engage with a $1\frac{1}{2}$ " Contrate Wheel 9 whilst in its second position the Pinion is thrown out of engagement and the clutch members are combined. The Pinion 5 remains in constant engagement with the Contrate 9, and in the second position of the lever the Contrate merely revolves idly.

Section V. Clutches, Reversing and Drive-Changing Mechanism—(continued)

S.M. 69—DRIVE-CHANGING GEAR

The Rod 1 slides in its bearings and is controlled by a lever 2, which is pivoted at 3 and rests between two Collars and Set Screws 4 on the sliding Rod 1. The latter carries a Crank 5, the web of which engages

between two Bevel Wheels 6 secured to a short Rod 7 driven from the Motor 8, as shown in the sectional illustration (S.M. 69A). The Crank 5 is suitably spaced with Washers 5A.

On operation of the lever 2, one of the Bevel Wheels 6 may be brought into gear with one or other of the two further Bevel Wheels 9 mounted on secondary shafts 10. This provides for two independent drives, either of which may be connected with the Motor by moving the lever 2.

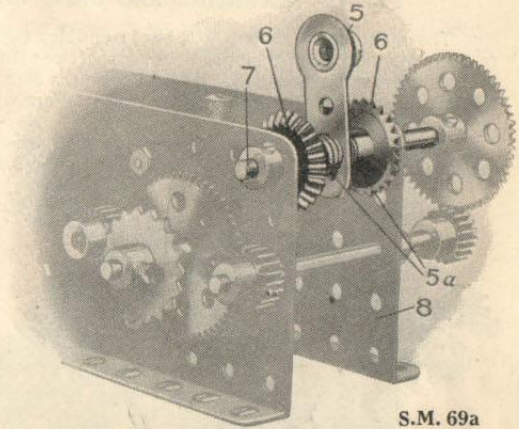

S.M. 69a

Detail of Drive-Changing Gear (S.M. 69)

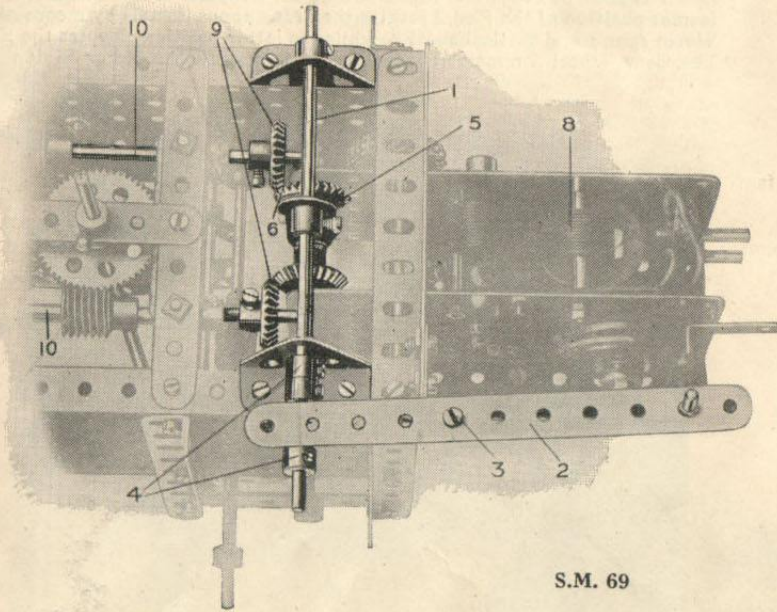

S.M. 69

S.M. 70—DRIVE-CHANGING GEAR

The driving Pulley 1 is mounted on a shaft 2 carrying a $\frac{3}{4}$ " Pinion 3 and $\frac{1}{2}$ " Pinion 4. These Pinions may be thrown in or out of engagement with the 50 and 57-teeth Gear Wheels 8 and 9 by sliding a handle 5, the Rod 6 of which carries a Crank 7 loosely journalled on the Rod 2 between the Pinion 4 and a Collar and Set Screw 10.

The Pinions 3 and 4 are so arranged on the shaft 2 that they cannot engage their respective Gear Wheels at the same time. This means that as one of the Pinions is moved into engagement with its Gear Wheel, the other is automatically thrown out of gear, and *vice-versa*.

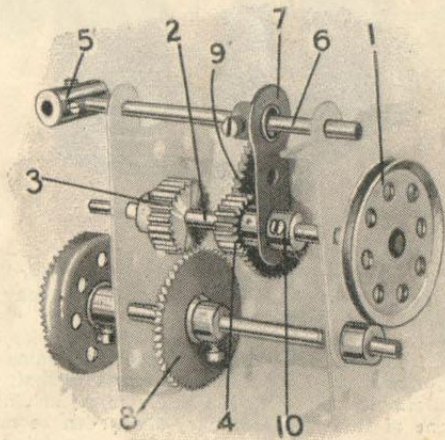

S.M. 70

Section V. Clutches, Reversing and Drive-Changing Mechanism —(continued)

S.M. 71—REVERSING AND DRIVE-CHANGING GEAR

The mechanism shown in S.M. 71 enables two or three different operations to be controlled from a single driving shaft separately or simultaneously and in forward or reverse direction. It is of compact construction, simple to control and reliable in action. The advantages that it offers when fitted to a crane or similar model are apparent.

The Rod 1, which takes the drive from the Motor, carries a $\frac{3}{4}$ " Pinion 2 secured in the position shown. A similar Pinion 3 is free to rotate on the Rod but

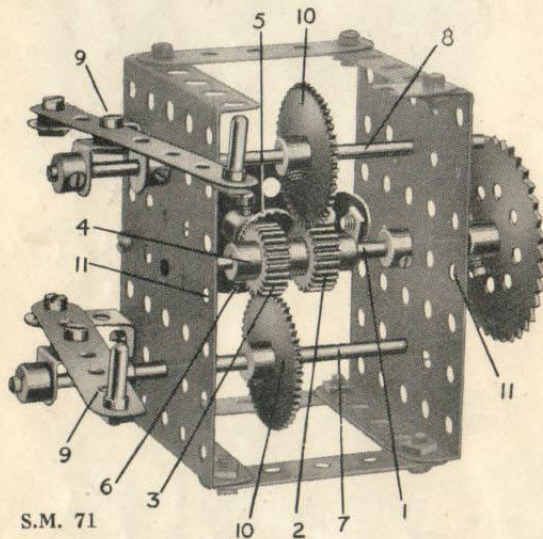

S.M. 71

is free to rotate on the Rod but is retained in position by a Collar and Set Screw 4. The Pinions engage with opposite sides of a $\frac{3}{4}$ " Contrate Wheel 5 and the latter is free to turn on a short Rod secured in the boss of a Bush Wheel 6. This wheel is bolted rigidly to the $2\frac{1}{2}$ " x $\frac{1}{2}$ " Double Angle Strip that connects the side Plates of the gear box.

It will be apparent that the Pinions 2 and 3 must rotate in opposite directions, for the former drives the Contrate Wheel 5 while the latter is driven by that wheel.

The secondary Rods 7 and 8 are slidable in their bearings and their movements may be controlled by suitable levers 9. Each Rod carries a 50-teeth Gear Wheel 10,

and on operation of its respective lever this Gear Wheel may be caused to engage with one or other of the Pinions 2 or 3, or it may be placed in neutral, i.e., in a central position between the Pinions.

A third shaft can be journaled in the holes 11 of the side Plates and controlled from the driving shaft 1 in exactly the same way. The gear box, therefore, enables the shafts 7 and 8 and the imaginary shaft journaled in the holes 11 to be driven simultaneously or separately from the single driving Rod 1. Moreover any one of the three secondary shafts can be reversed or thrown out of gear without affecting the operation of the remaining two or altering the direction of rotation of the Rod 1.

S.M. 72—DRIVE-CHANGING GEAR

On operation of the lever 1, the Rod 2 may be moved to and fro in its bearings, so causing the 57-teeth Gear Wheel 3 to engage with the $\frac{1}{2}$ " Pinion 4 or the $\frac{1}{2}$ " Pinion 5 with the Contrate Wheel 6.

The gear box shown is fitted to a model Pontoon Crane, in which the former position of the Rod 2 rotates the Crane about its axis by means of a Worm gear 7 and vertical shaft 8, while the latter position elevates the jib. The Gear Wheel 3 remains constantly in mesh with the Motor Pinion 9.

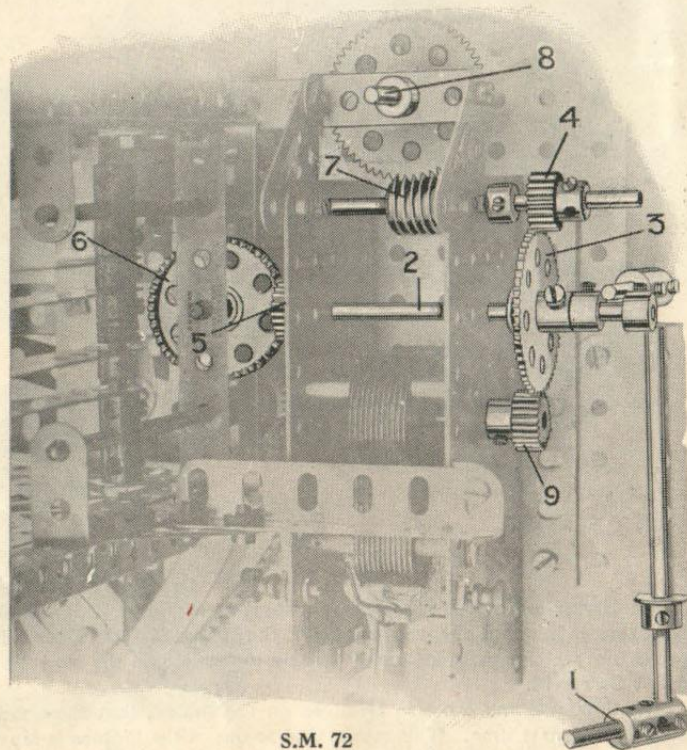

S.M. 72

Section V. Clutches, Reversing and Drive-Changing Mechanism—(continued)

S.M. 73-75—DOG CLUTCH MECHANISM

S.M. 73 shows the standard Meccano Dog Clutch, which consists of one male and one female section. The object of this part is to enable two shafts to be engaged with each other or disengaged whenever desired. The shafts must be mounted end to end and one must be slidable in its bearings so that the clutch sections can be thrown in or out of engagement on operation of a suitable lever.

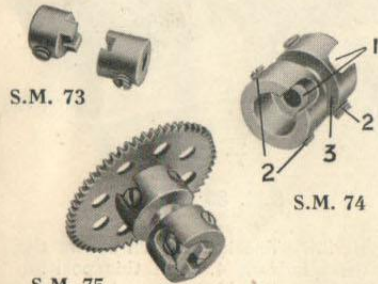

Alternatively, the clutch may be used in conjunction with the Socket Coupling (S.M. 74) to enable a Gear Wheel or Pinion, etc., to be mounted on a shaft so that it can either be carried round bodily with the shaft or allowed to remain stationary whilst the shaft carrying it turns in its boss. The slots 1 of the Socket Coupling enable the clutch sections or bosses of wheels to be inserted in the sockets without removing the set-screws. The grub-screws 2 secure the wheels or clutch sections in position by gripping them on opposite sides very tightly. For an explanation of the use of the groove 3, see S.M. 76-77.

S.M. 75 shows a Socket Coupling used to connect one section of a Dog Clutch to a 57-teeth Gear Wheel. The unit so formed should be mounted so that it can revolve freely about its shaft, and care should be taken therefore to see that the set-screws of the two parts do not touch the shaft. The other section of the Dog Clutch should be secured to the shaft. The unit may then be caused to revolve bodily with the shaft merely by moving it longitudinally so that the clutch jaws engage. The possibilities of such an arrangement when applied to gear boxes, etc., are indicated in S.M. 79-81a.

The Socket Coupling has many other uses, of course. It is often required in Meccano model-building to construct a length of hollow shafting, and this can be done by joining two or three Socket Couplings end to end by means of ordinary Couplings.

S.M. 76-77—GEAR CHANGE LEVERS

The groove in the Socket Coupling (S.M. 74) is provided to facilitate the operation of such units as S.M. 75. The groove engages with a pin or arm attached to the manipulating lever, so that on operation of the latter, the Socket Coupling may be moved along its shaft. Suitable levers are shown in S.M. 76 and 77. In the former the short Rod 1 engages with the groove and the Socket Coupling is moved on operation of the handle 2. The construction of the lever shown in S.M. 77 is identical at each end, and either of the two Threaded Pins may be used to engage the Socket Coupling.

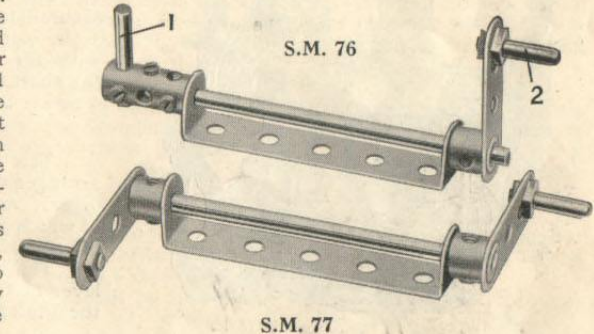

S.M. 78—GEAR CHANGING LEVER WITH QUADRANT

This is a type of hand lever particularly adaptable for effecting gear changes, such as those in S.M. 79-81a. A bolt 1 is screwed into the Collar 2 without touching the Rod 3, and is then secured by locking the nut 4 against the Collar. Two further Collars hold the Collar 2 in position. The shaft 3 may be moved longitudinally in its bearings on operation of the lever 5, which is connected to the Crank 6 by Rod 7. The Bolt 1 slides freely in the elongated hole of the Crank.

The lever 5 is spaced by Washers 8 so that a bolt 9 presses against a $2\frac{1}{4}$ " small radius Curved Strip 10, which forms the quadrant. The head of the bolt (which is of the new rounded-head type) tends to slip into the holes in the Strip 10 and thus retain the lever 5 firmly in any one of three different positions. The gearing on the shaft 3 should be arranged so that the different engagements are brought about at these three positions of the lever 5; then the gears will not easily ride out of engagement once the lever has been moved.

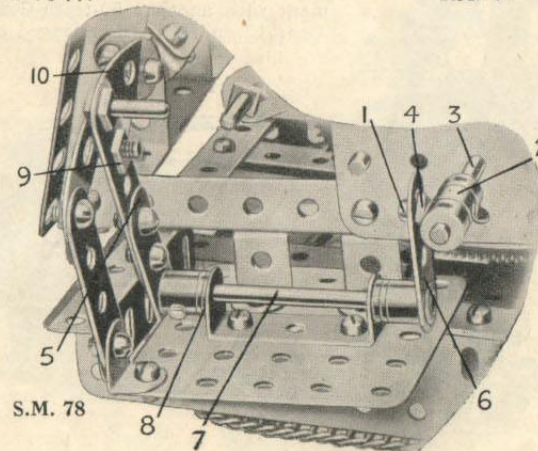

Section V. Clutches, Reversing and Drive-Changing Mechanism —(continued)

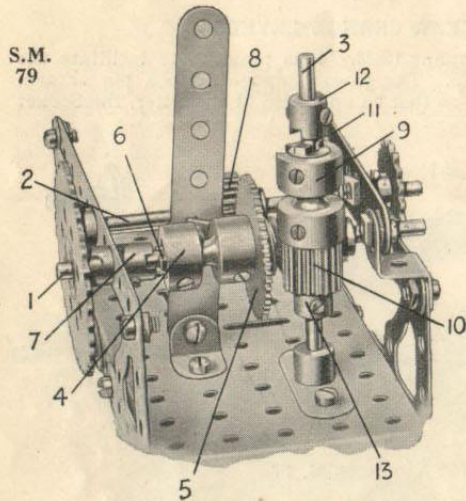

S.M. 79—DOG CLUTCH GEAR CHANGE

S.M. 79 shows how two separate drives may be actuated separately or simultaneously from a single driving shaft without sliding the latter in its bearings.

The Rod 1 forms the driving shaft, while 2 and 3 are secondary shafts. The Socket Coupling 4 connects a Gear Wheel 5 to a clutch member 6, the whole unit being free on the Rod 1. A movement of the control lever to the left brings the clutch member 6 into engagement with the clutch member 7, when the drive is transmitted to the shaft 2 via Pinion 8.

The Socket Coupling 9 connects a clutch section to the $\frac{1}{2}$ " Pinion ($\frac{1}{2}$ " face) 10, and on raising lever 11 the clutch section may be engaged with the clutch 12 secured to the shaft 3. Pinion 10 is in constant mesh with a Worm on the Rod 1. Collar 13 merely acts as a stop. Both operating levers are provided with a bolt the shank of which engages the groove of its respective Socket Coupling.

S.M. 80—DOG CLUTCH GEAR CHANGE

This is another example of gear changing by means of Dog Clutch mechanism. The lever 1 and connecting gear is arranged similarly to S.M. 76, and the upper end of the 1" Rod 2 engages with the Socket Coupling 3. The latter serves to connect a Gear Wheel 4 with a male Dog Clutch section 5, the whole riding as a unit upon the Rod 6. The Gear 4 may be driven continuously by a Pinion secured to the Motor armature 7. By moving the lever 1 the clutch member 5 may be brought into engagement with the female clutch member 8, which is secured to the shaft 6; as soon as this happens the Gear 4 and shaft 6 rotate bodily and the drive is transmitted to the model.

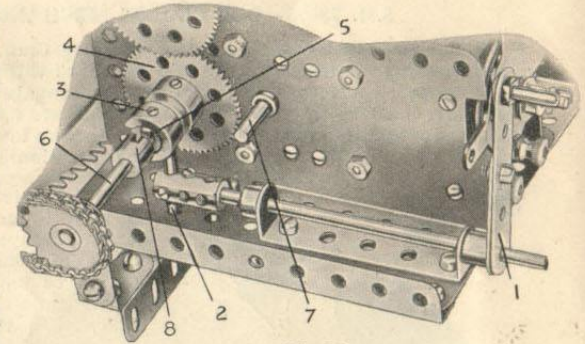

S.M. 80

S.M. 81—SLIDING GEAR CHANGE

This is a typical Meccano gear box. The particular arrangement illustrated is designed to operate a mechanical digger, and provides for four different motions, three of which are brought in or out of engagement on operation of a sliding layshaft.

The lever 1 is arranged as in S.M. 78 and operates the sliding layshaft 2. The illustration shows the lever in the central position, with the bolt 3 engaging the central hole of the quadrant 4. In this position the Pinion 5 engages with the Gear Wheel 6, which is secured to the winding shaft 7. If the lever 1 is moved to position A in the quadrant, the Pinion 5 is thrown out of engagement and the Bevel 8 brought into engagement with the Bevel 9, thus operating the traversing gear. If the lever 1 is moved to position B, the Pinion 5 is brought into engagement with another 50-teeth Gear 10 on a Rod which controls the racking gear. Gear 12 on Rod 2 is engaged constantly by the $\frac{1}{2}$ " x $\frac{1}{4}$ " driving Pinion 11.

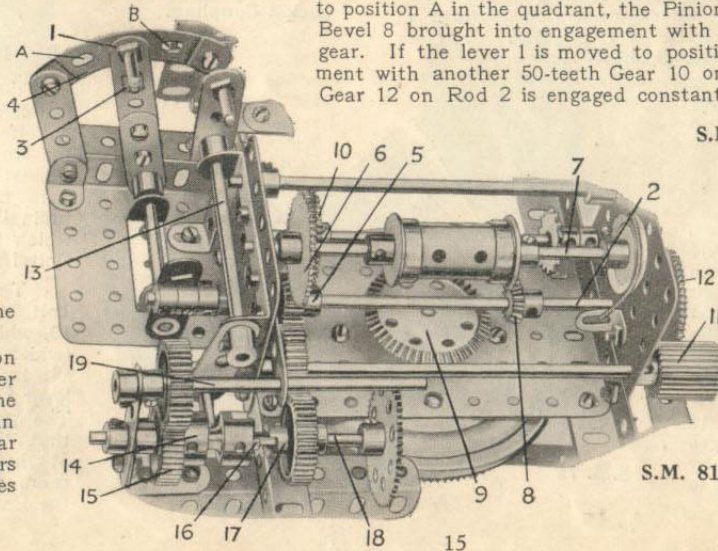

S.M. 81

S.M. 81a—DOG CLUTCH GEAR CHANGE

The fourth movement in the above gear box (S.M.81) is controlled by means of a sliding gear and Dog Clutch mechanism. The manipulating gear 13 is similar to S.M. 77, and the Threaded Pin at one of its ends engages the groove of the Socket Coupling 14, which connects the 1" Gear 15 with a Dog Clutch section 16. On operation of the lever the latter may be thrown in or out of engagement with the other Dog Clutch section 17 secured to the shaft 18, which is driven continuously. The Gear 15 is always in engagement with a similar Gear on the Rod 19; hence this Rod 19 may be set in motion merely by engaging the clutch.

Section V. Clutches, Reversing and Drive-Changing Mechanism—(continued)

S.M. 82—EPICYCLIC GEAR CLUTCH

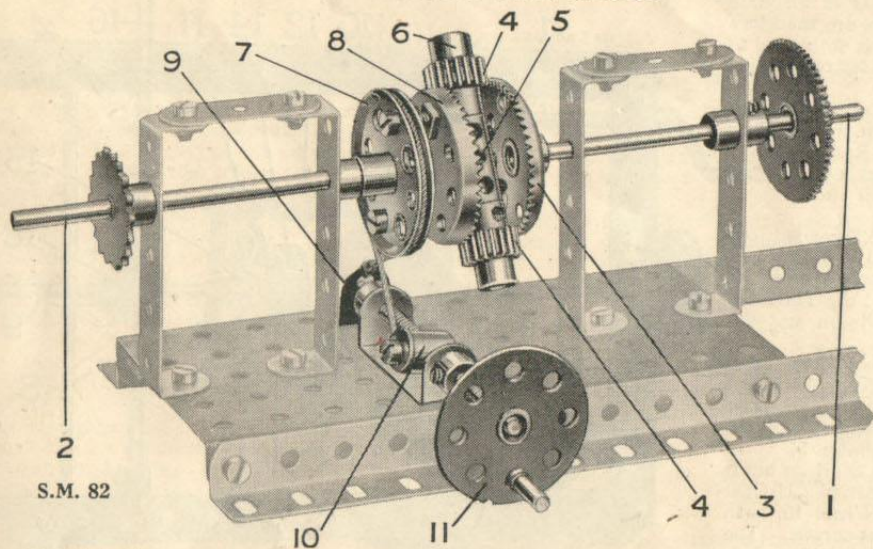

S.M. 82

Rod 1 is the primary, or driving shaft, and Rod 2 is the secondary, or driven shaft. The former carries a $1\frac{1}{2}$ " Contrate Wheel 3, which engages with $\frac{1}{2}$ " Pinions 4 mounted on 1" Rods secured in the ends of a Coupling 5. The Pinions are free to revolve, but are held in place by Collars 6. Rod 2 passes through the bosses of a Pulley 7 and the second $1\frac{1}{2}$ " Contrate Wheel 8, and its inner end is secured in the centre of the Coupling 5. The Pulley 7 and Contrate Wheel 8 are free to turn independently of the Rod 2, but they are secured together by two $\frac{1}{4}$ " Bolts, each of which is fitted with three nuts, one immediately behind Pulley 7 and one on each side of the Contrate 8.

The Wheel 7 is controlled by a friction brake consisting of a length of cord, one end of which is tied to an Angle Bracket 9 and the other end to a Threaded Boss 10 mounted on a Threaded Rod that carries a hand wheel 11.

If the brake is in the "off" position, that is with cord slack, the unit 7 and 8 is free to revolve about the Rod 2. Hence if power is applied to the Contrate Wheel 3 the Pinions 4 commence to turn upon their axes, driving the Contrate Wheel 8 in an opposite direction, and no movement is imparted to the Rod 2. If the hand wheel 11 is rotated, so gradually applying the brake, the Contrate Wheel 8 becomes increasingly difficult to turn, and the Pinions 4 commence to climb round its teeth, thereby rotating the Coupling 5 and the Rod 2.

It will be seen that by means of this clutch the power can be applied to the load very smoothly and without shock, for the Rod 2 commences to rotate immediately the resistance on the Pulley 7 becomes greater than the load (that is the resistance on Rod 2). The speed of the latter Rod increases in proportion to the increase in the resistance on Pulley 7. The gear ratio is 1 : 2 when the unit 7, 8 is immovable—that is, Rod 2 rotates once in every two revolutions of Rod 1.

S.M. 83—EPICYCLIC TRANSMISSION GEAR

This device is designed to provide a gear ratio of two to one between any two shafts. Its chief merits lie in the compactness of its construction and in the fact that the driving and driven shafts may be mounted in direct line with one another.

The handle 1 is secured to a 2" Axle Rod journalled in bearings 2. This Rod is free to rotate in the boss of a $1\frac{1}{2}$ " Contrate Wheel 3, but is secured in one end of the Coupling 4. A further Rod 5, which runs freely in the other end of the Coupling 4 and is journalled in further reinforced bearings 6, carries the $1\frac{1}{2}$ " Contrate Wheel 7 fixed in the position shown.

A $1\frac{1}{2}$ " Rod 8 gripped in the central transverse hole of the Coupling 4 carries a $\frac{3}{4}$ " Pinion 9, which is free to rotate about the Rod but is retained in position by a Collar 10. The Pinion is engaged by the teeth of both Contrate Wheels 3 and 7.

The Double Bent Strip forming the bearing 2 for the driving Rod is bolted to the plate by two $\frac{1}{4}$ " Bolts, the shanks of which enter holes in the Contrate Wheel 3 and so prevent the latter from rotating.

It will be found that the secondary shaft 5 rotates twice as fast as the driving Rod carrying the handle 1. Alternatively, by using the Rod 5 as the driving shaft, a one in two reduction gear will be obtained, for the 2" Rod will revolve once only to every two revolutions of the Rod 5. By repeating the device two or three times in a straight line, a very compact transmission gear may be obtained.

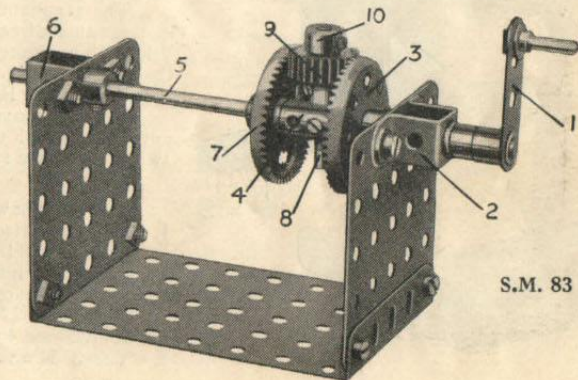

S.M. 83

Section V. Clutches, Reversing and Drive-Changing Mechanism—(continued)

S.M. 84—PLANETARY GEAR BOX

A planetary gear box of the type shown in S.M. 84 is unique so far as Meccano construction is concerned. In actual practice planetary or epicyclic gears are used to a large extent, but in almost every case an internal-toothed wheel or drum is employed to actuate the planet wheels or idler pinions. The Meccano gear box provides two speeds forward, reverse, and neutral gears.

The drive is taken from the Rod 1 and the motion is transmitted through the gear box to the driven Rod 2. A $\frac{1}{2}$ " Pinion on the driving Rod engages with the $3\frac{1}{2}$ " Gear Wheel 3, which is free to rotate independently about the Rod 2. The $2\frac{1}{2}$ " Rod 4 is journaled in one of the holes in the face of the Gear Wheel 3 and carries a $\frac{3}{4}$ " Pinion 5, 1" Gear Wheel 6 and $\frac{1}{2}$ " Pinion 7, all fixed to the Rod. Its other end is supported in a $2\frac{1}{2}$ " Strip 8 that is free to turn on the Rod 9.

The $\frac{3}{4}$ " Pinion 10 is immovable, being gripped by its set-screw to a 2" Threaded Rod secured to the Gear Wheel 3 in a hole opposite to the Rod 4. Two nuts, one placed behind the $3\frac{1}{2}$ " Gear Wheel and the other on the Threaded Rod immediately against the boss of the Pinion 10, are screwed up very tightly to secure the Pinion and the Threaded Rod rigidly to the wheel 3. Two Washers are placed between the Pinion and the $3\frac{1}{2}$ " Gear Wheel.

The other end of the Threaded Rod enters a Threaded Boss 11 secured to the Strip 8 by a $\frac{3}{8}$ " Bolt. The Coupling 12 is added to assist in balancing the weight of the Rod 4 and its components. The 50-teeth Gear Wheel 13, which forms the sun wheel, is secured to the driven Rod 2, and a Compression Spring is placed between it and the wheel 3. The spring normally holds the wheel 13 in gear with the $\frac{3}{4}$ " Pinion 5.

The Rod 9 is slidable in its bearings but is prevented from rotating. It carries a 1" Gear Wheel 14 and 57-teeth Gear Wheel 15, both secured in position by their set-screws. The Rod protrudes about $\frac{1}{8}$ " beyond the Gear Wheel 14. The operating lever 16, which pivots about a point 17, carries a Double Bracket fitted with a bolt that enters a Coupling 18 secured to the Rod 9.

The mechanism is shown in reverse gear with Gear Wheel 15 engaging Pinion 7. In this position Rod 2 rotates in the same direction as the driving Rod. "Neutral" is obtained by pushing the lever 16 forward so that the Gear Wheel 15 is disengaged from the Pinion 7; in this position the mechanism rotates bodily round the Rod 2 without turning the sun wheel 13. Additional movement of the lever brings Gear 14 into engagement with the corresponding Gear 6, thereby causing Rod 2 to turn slowly in an opposite direction to the driving Rod. This corresponds to a slow forward speed.

Further movement of the lever presses the protruding end of Rod 9 against the end of Rod 2 and throws the wheel 13 out of gear with the Pinion 5 and into engagement with the fixed Pinion 10. This locks the wheel 13 to wheel 3 and the two rotate as a single unit, thus producing, in effect, a straight-through drive. Rod 2 now rotates at maximum speed.

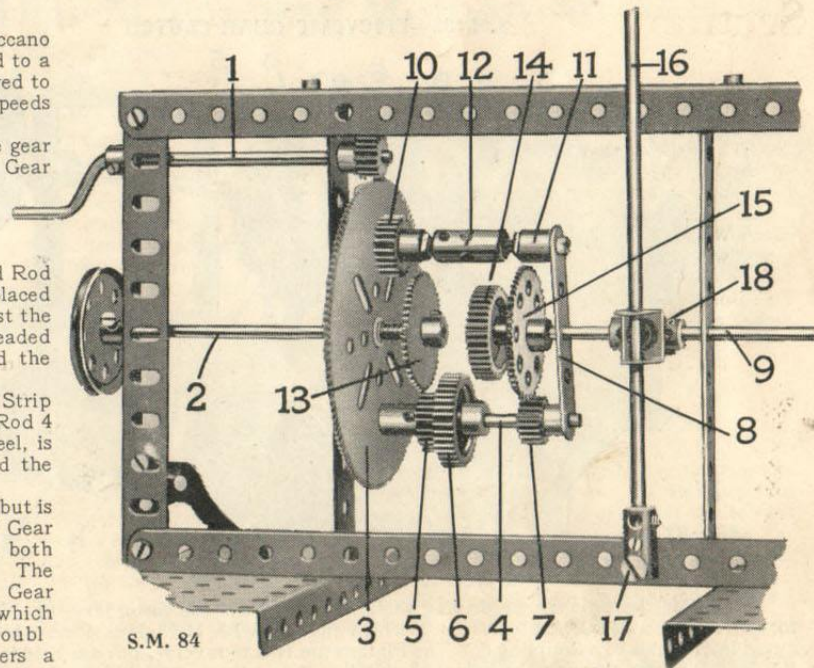

S.M. 84

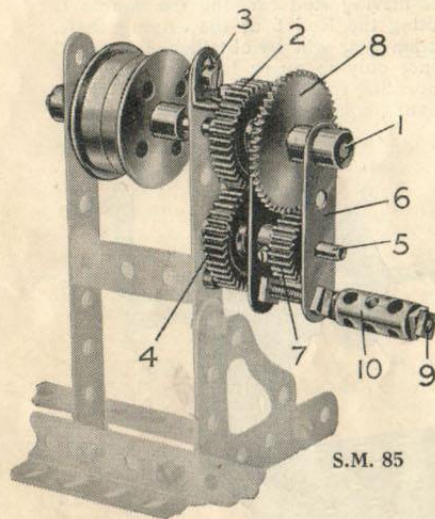

S.M. 85

S.M. 85—SUN AND PLANET GEAR

S.M. 85 shows how it is possible to obtain a gear reduction of 2 : 1 between an operating handle 10 and a driven shaft 1, while the latter forms the centre about which the handle revolves.

The shaft 1 is free to turn in a 1" Gear 2, which is secured to the framework by a bolt passed through an Angle Bracket 3 and inserted in the threaded bore in the wheel boss. The bolt is secured by a nut beneath the Angle Bracket and must be spaced by Washers to clear the shaft 1. A second 1" Gear 4 engages with Gear 2, and is secured to a $1\frac{1}{2}$ " Rod 5 journaled in 2" Strips 6 which are free to turn about the shaft 1. Washers are placed between the inner 2" Strip and the Gears 2 and 4 for spacing purposes. The Rod 5 carries a $\frac{3}{4}$ " Pinion 7 engaging with a 50-teeth Gear 8 secured to the shaft 1. The 2" Screwed Rod 9 serves to secure the Strips 6 in position, and is fitted with a Coupling 10 to form the handle.

Section V. Clutches, Reversing and Drive-Changing Mechanism—(continued)

S.M. 86—AUTOMATIC GEAR-CHANGE

S.M. 86 represents a gear box which, if called upon to withstand a sudden increase of load on the driven shaft, automatically changes over from high gear into low.

The driving shaft of the gear box is in two sections, 1a and 1b, and is connected to the Motor by means of Sprocket Chain or other suitable method. The countershaft 3 is connected in any convenient manner to the mechanism that is required to be set in motion. The 3" Rod 1a carries a Bush Wheel 4, which is coupled by two pieces of cord to a second Bush Wheel 5. The latter is free to ride up or down the shaft 1a.

Two 1½" Double Angle Strips secure the Bush Wheel 5 to a 57-teeth Gear 7 mounted on the end of the 3" Rod 1b. This Rod carries a 1" Gear 8 and a Compression Spring 9. The Spring tends to maintain the cords 6 outstretched as shown in the illustration, and in this position the Gear 7 is in engagement with a ½" Pinion 11 on the countershaft 3. This gives a speed ratio of 3 : 1.

The Gear 7 will continue to drive the Rod 3 considerably faster than the driving shaft so long as the load or resistance on that Rod remains light, but if the load is increased suddenly, the shaft 1a and Bush Wheel 4 commence to revolve faster than the Bush Wheel 5. But when this takes place the cords 6 are twisted slightly, with the result that the wheel 5, sliding on the Rod 1a, is drawn nearer to the wheel 4. This movement throws the Gear 7 out of engagement with the Pinion 11 and causes the Gear 8 to mesh with a similar Gear 10 on the countershaft 3, thus producing a low speed gear having a 1 : 1 ratio. To bring this about, however, the Spring 9 must be compressed; therefore the two 1" Gears will remain in engagement only while the load on the shaft 3 is greater than the pressure of the Spring.

Immediately the load drops below a certain amount, the Spring re-asserts its influence over the cords 6 and the gear is returned to its normal or "top" speed position.

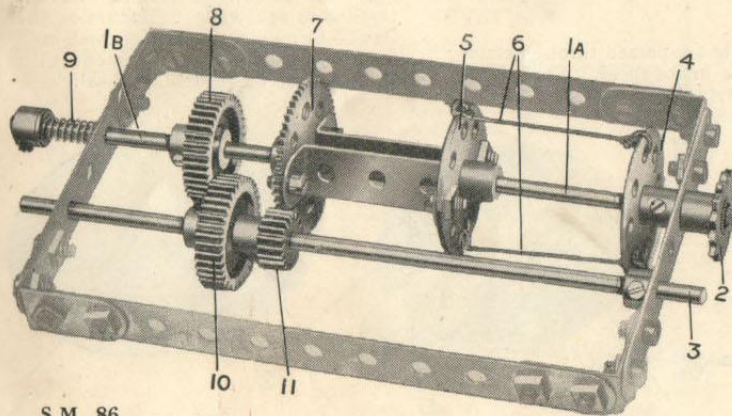

S.M. 86

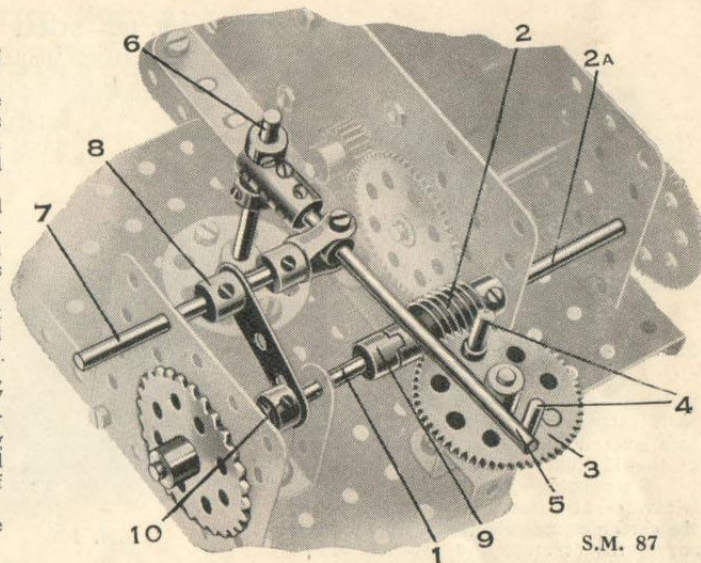

S.M. 87

S.M. 87—INTERMITTENT ROTARY MOTION

The device shown in S.M. 87 is designed to convert continuous rotary motion to intermittent rotary motion. Rod 1 is the driven shaft. The drive from the Motor is led by any suitable means to a Worm Wheel 2 that meshes with a 57-teeth Gear Wheel 3, in the face of which two Threaded Pins 4 are secured.

As the Gear Wheel 3 slowly rotates the Threaded Pins 4 alternately press against the end of a 3½" Rod 5, which is secured in a Coupling mounted on any suitable pivot 6. A Swivel Bearing forms a pivotal connection between the Rod 5 and a 2½" Rod 7. This Rod 7 carries a Crank 8, through the end hole of which is journaled the driven shaft 1. The latter slides in its bearings and carries on its inner end a Dog Clutch section 9, the corresponding clutch section being secured to the driving Rod 2a. The clutch is normally held in engagement by means of a Compression Spring mounted on the driven shaft and pressing against a Collar 10.

When one of the Pins 4 strikes the lever 5, the Rod 7 is pushed back in its bearings, the Spring on the Rod 1 is compressed and the clutch members 9 disengaged. The Motor then rotates independently until the Gear Wheel 3 has carried the Threaded Pin far enough to allow the Rod 5, through the action of the Spring on Rod 1, to slip back to normal position, when the Clutch is re-engaged. The cycle of operations is repeated when the second Threaded Pin strikes the Rod 5.

Section VI. BRAKES AND GOVERNING APPLIANCES

S.M. 102—STRAP AND WEIGHTED LEVER BRAKE

This brake is similar to that described in S.M. 81, except that the lever 1 carries a Flanged Wheel, which is secured by its set-screw to the shank of a bolt passing through a hole in the lever. The weighted lever so obtained imparts a continual pressure of the cord 2 about the 1" Pulley 3, and this pressure is designed to overcome any tendency of "back-slip" in the shaft secured to the Pulley.

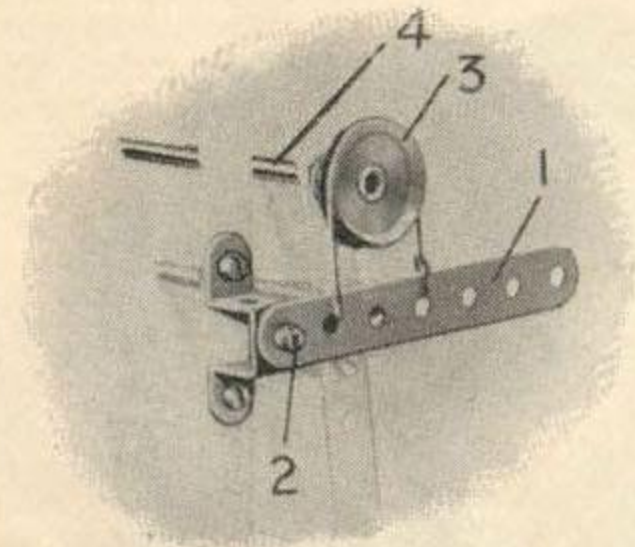

S.M. 101—STRAP AND LEVER BRAKE

A short cord, representing the strap which in actual practice is usually faced with leather or wood, is tied at both ends to a lever 1, and passes round the groove of the 1" Pulley 3 secured to a Rod 4. On pressing down the lever 1, which is pivoted at 2 (see S.M. 262), the grip of the cord increases about the Pulley 3 and so retards or stops the rotation of the shaft 4.

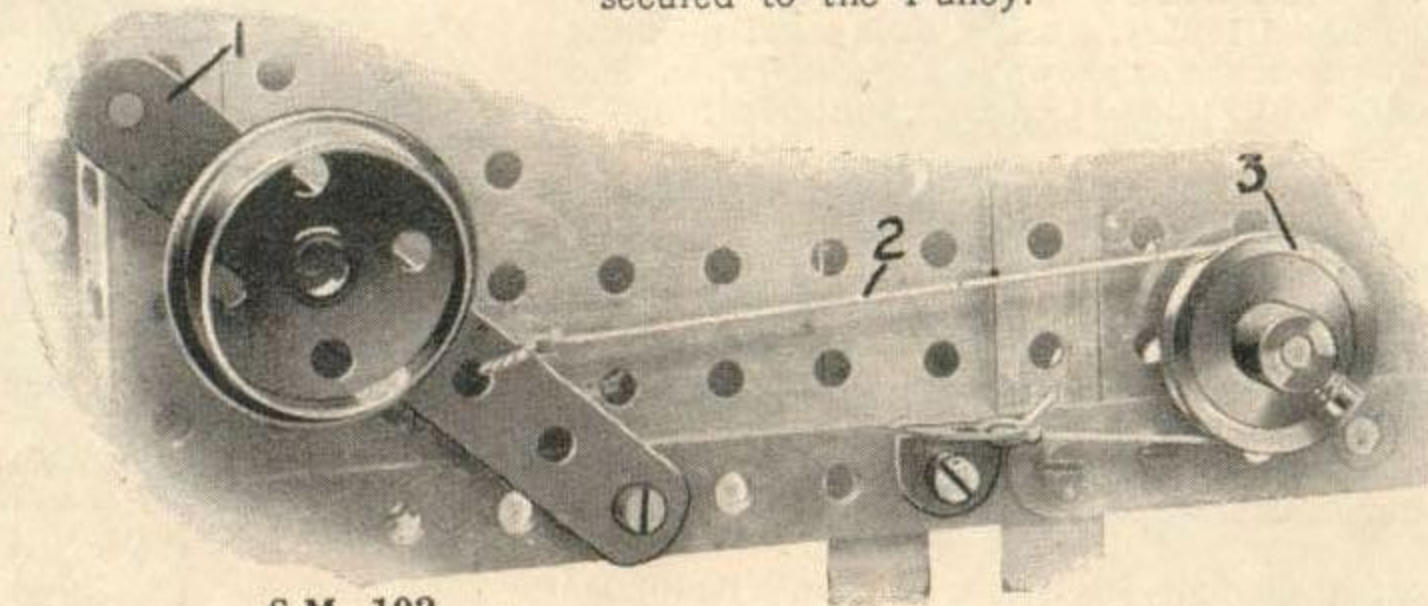

S.M. 102

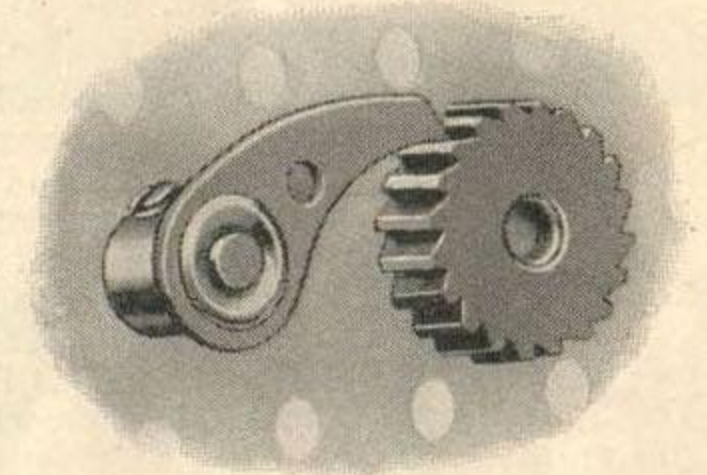

S.M. 103—PAWL AND RATCHET WHEEL

This illustrates the standard Meccano Pawl and Ratchet Wheel gear, which allows the shaft carrying the Ratchet Wheel to rotate in one direction only. The advantages of such an arrangement are obvious, especially when attached to model Cranes, hoisting-tackle, etc., where the Pawl and Ratchet gear prevents falling-back of the load as it is hoisted.

It is sometimes found advantageous to apply slight pressure on the Pawl—by means of a spring or weighted lever—to ensure its engagement with the teeth of the Ratchet Wheel.

S.M. 104—INTERNAL EXPANDING BRAKE

This brake is suitable for incorporation in the wheels of a motor car, etc. Two $\frac{1}{2}$ " Bolts are passed through slots in the Face Plate 1, through $1\frac{1}{2}$ " Strips 2, and are then secured in Collars 3, which form the brake shoes. Each bolt carries a Washer under its head and two on its shank between the Face Plate and the Strips 2. The latter are pivoted to a $2\frac{1}{2}$ " Strip 5 that turns about the axle 4. When the $2\frac{1}{2}$ " Strip is moved, the Collars are thrust outward along the slots and pressed against the inside periphery of a Wheel Flange 6 bolted to the inside of the road wheel (the latter is shown removed from the axle). Three Washers should be placed on the axle 4 between the Strip 5 and the Face Plate. The Collars 3 are connected by a short length of Spring Cord, which returns the brake to the "off" position when the Strip 5 is released.

The brake rod 7 consists of two Healds (Part No. 101). It is connected pivotally to the Strip 5 and to a Crank 8, which is secured to a Rod carrying the hand lever by which the brake is operated.

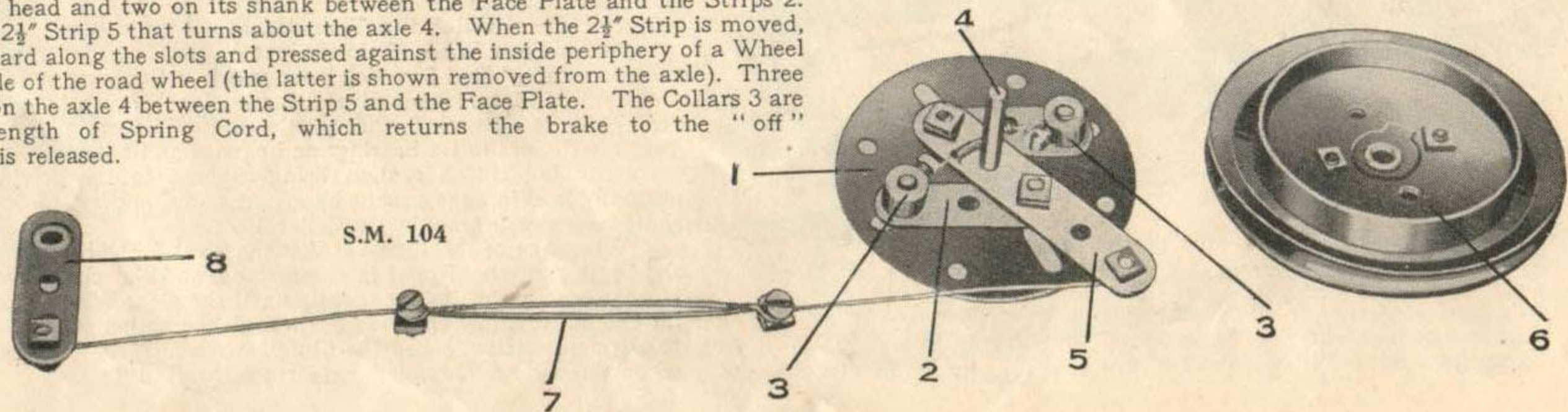

S.M. 104

Section VI. Brakes and Governing Appliances—(continued)

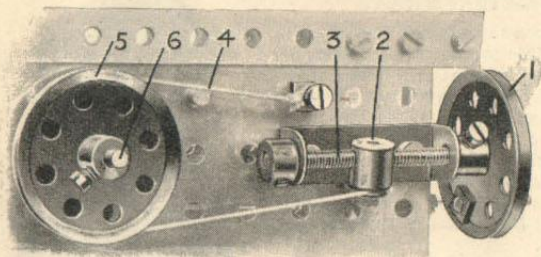

S.M. 105—STRAP AND SCREW BRAKE

Rotation of the hand-wheel 1 causes the Threaded Boss 2 to travel in either direction along the Threaded Rod 3, thus diminishing or increasing the grip of the cord 4 engaging the Pulley 5, which revolves with the driven shaft 6.

An advantage of this brake is that the speed of the shaft 6 may be varied as required, or the pressure of the cord 4 altered to meet different loads; the grip of the cord 4 about the Pulley 5 cannot vary when once set unless the hand-wheel 1 is turned.

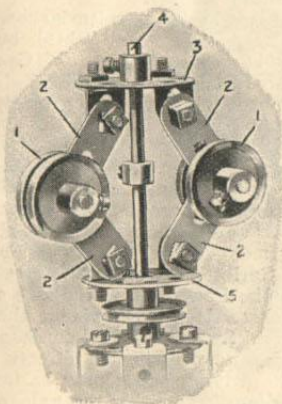

S.M. 107

S.M. 107—CENTRIFUGAL GOVERNOR

The weights 1 are carried on $1\frac{1}{2}$ " Strips 2 pivotally connected to a Bush Wheel 3 secured to the vertical Rod 4, and to another Bush Wheel 5 sliding freely upon the Rod 4. This latter Rod is driven by any suitable method from the engine or motor; as the speed at which it rotates increases, the weights 1 fly outward, with the result that the Bush Wheel 5 moves up the Rod 4. This movement of the Wheel 5 is employed to gradually apply a brake or some other retarding contrivance, so preventing any tendency of the engine or motor to "race."

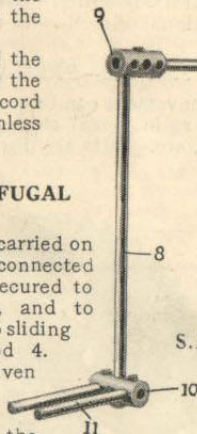

S.M. 108a

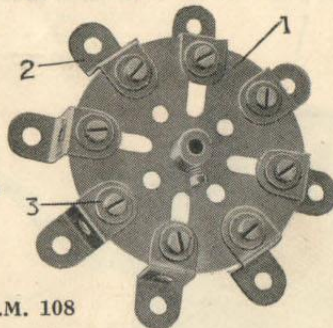

S.M. 108

latter is bolted on a 6" Rod 7, and a 5" Rod 8 is secured in a Coupling 9 on the end of the Rod 7. At the lower end of this 5" Rod is a Coupling 10 carrying two 2" Rods 11. The escapement 7 is mounted pivotally in the Clock case just above the escapement wheel, and the pendulum, suspended from a suitable pivot, passes through the fork 11. As the pendulum swings to and fro the arm 5 rocks about its axis, so allowing the Bracket 4 alternately to release a tooth of the escapement wheel 1.

S.M. 106—SCREW-OPERATED DOUBLE BAND BRAKE

This is an efficient type of brake which should prove useful in many Meccano models. The speed of the mechanism which it controls may be varied to accurate degrees and when fully contracted it forms a powerful and rigid brake.

Rotation of the hand-wheel 1 brings together the brake bands 2 and 3, thus applying a firm grip on the drum 4 formed from two Flanged Wheels mounted on the driven shaft. The Strip 2 is bolted to a Threaded Crank 5 engaging the Threaded Rod 6 of the hand-wheel, and the Strip 3 presses against a Threaded Boss 7. The Threaded Boss revolves with the Rod 6, to which it is locked by means of a nut also mounted on the Rod 6 and screwed tight against the outer end of the Boss. The Rod 6 should be allowed sufficient play to move to and fro in its bearings as the brake bands contract or open. The brake bands are bolted at their lower ends to Double Brackets pivotally carried on $1\frac{1}{2}$ " Rods.

They may be lined with leather or other material at the points of contact with the brake drum, although such a lining is not essential in the Meccano model.

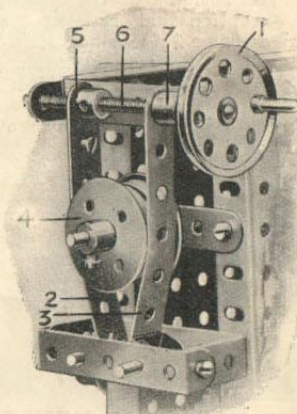

S.M. 106

S.M. 108 and 108a—CLOCK ESCAPEMENT

The commonplace, yet very ingenious, contrivance by which the speed of clock mechanism is controlled forms an interesting subject. S.M. 108 illustrates the escapement wheel, and S.M. 108a the crutch mechanism, from the Meccano Clock. The escapement wheel consists of a Face Plate 1, to which are attached eight $\frac{1}{2}$ " Reversed Angle Brackets 2. Washers 3 are placed beneath the heads of the bolts to ensure that the Brackets 2 are held very rigidly in place. The crutch is formed from Angle Brackets 4 bolted to the arm 5, which consists of two $2\frac{1}{2}$ " reversed Curved Strips bolted one on either side of the web of a Crank 6. The

Section VI. Brakes and Governing Appliances—(continued)

S.M. 109—STRAP AND LEVER BRAKE

This is similar to the brake described in S.M. 89 with the exception that the lever 1 operates in a quadrant 2 formed of two $2\frac{1}{2}$ " small radius Curved Strips connected to the frame by means of a $1\frac{1}{2}$ " Strip 3 and a Flat Trunnion 4. The lever should be gripped firmly by the Curved Strips so that it will remain in any required position.

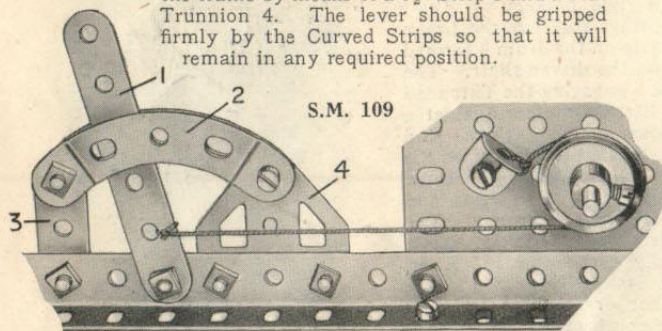

S.M. 109

S.M. 111—SAFETY CATCH FOR WINDING GEAR

The Compression Spring 3 is mounted on the Crank Handle 1 between the Collar 4 and a Washer, and normally holds the Collar 2 against the inner side of the plate. The latter Collar is fitted with a $\frac{3}{8}$ " Bolt, and should the Crank Handle commence to rotate, the head of this bolt strikes against the stop 5 and prevents further movement. Hence in order to operate the model it is necessary to push the Crank Handle inward slightly so that the $\frac{3}{8}$ " Bolt clears the stop 5.

The safety catch proves of value if used as an automatic brake for counter-shafts in models driven by a Meccano Motor. For example, suppose the Rod 1 operates the jib in a model crane that is driven by an Electric Motor. By means of a suitable hand lever the Rod 1 may be arranged so that it is in engagement with the main driving shaft only while the Spring 3 is depressed. On releasing the hand lever Rod 1 is thrown out of gear and the jib is locked in position immediately.

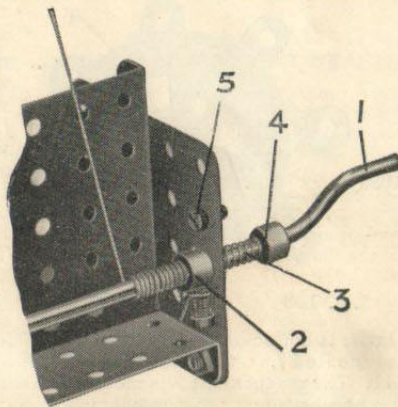

S.M. 111

S.M. 110—REVERSIBLE FRICTION BRAKE

This brake is arranged to apply to a shaft a braking effect in one direction only. The particular direction of rotation may be predetermined, however, by a simple movement of a lever. Thus the device forms a kind of ratchet, the controlling effect of which is more gradual and smooth than that obtainable in the more usual pawl and toothed-wheel method.

The $1\frac{1}{2}$ " Pulley 1 is secured to the shaft that is to be controlled and is engaged by a cord 2, the ends of which are tied to the ends of a $3\frac{1}{2}$ " Strip 3. The latter slides in an Eye Piece 4 secured to the frame. Two bolts are inserted in the Strip 3 to prevent it from sliding beyond certain limits.

With the lever 3 in the position shown, the wheel 1 is free to rotate in an anti-clockwise direction, but if it is turned clockwise a powerful retarding effect is generated. By sliding the Strip 3 until the other stop strikes the Eye Piece, the effects of the brake are reversed and the wheel 1 is then free to rotate in a clockwise direction only. The brake is entirely automatic, and is applied immediately the rotational direction is reversed.

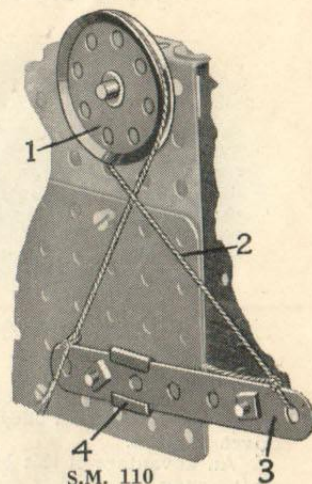

S.M. 110

S.M. 112—FREE WHEEL DEVICE

A "free-wheel" movement can be used in all models where it is required to transmit the drive in one direction only, as in model bicycles, clock-winding mechanisms, all models operated by treadles, pedal motors, etc. It is also invaluable for converting reciprocating motion into intermittent rotary motion.

The free-wheel mechanism is shown attached to a 3" Sprocket Wheel, but this may be replaced by a $3\frac{1}{2}$ " Gear Wheel, large Pulley, or Face Plate, etc. The Sprocket revolves freely on its axle, but is kept in position by the Ratchet Wheel secured to the axle on one side and a Collar on the other side.

Two Pawls are mounted pivotally on the face of the Sprocket by means of Pivot Bolts and lock-nuts and are held in engagement with the Ratchet by pieces of Spring Cord attached to set-screws in the Pawls and to the face of the Sprocket. It will be evident that the axle and Sprocket Wheel can each move independently in one direction only. The driving power may be imparted primarily to either the axle or the Sprocket, to suit requirements.

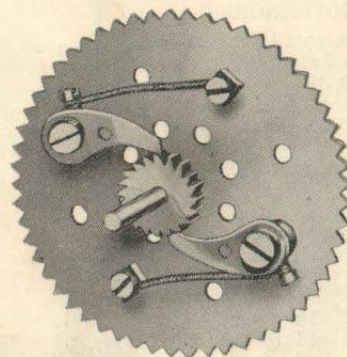

S.M. 112

Section VI. Brakes and Governing Appliances—(continued)

S.M. 113—SPEED GOVERNOR FOR ELECTRIC MOTOR

This is an accurate model of the governor device used in certain types of electric lift, and it can of course be used in all Meccano lifts, and in fact in all models that are driven by Electric Motors.

The governor consists essentially of two Simple Bell Cranks 4 pivoted to two horizontal $3\frac{1}{2}$ " Strips, which are secured rigidly by bolts inserted one in each side of a Collar secured to the governor spindle 1, two Washers on each bolt being used for spacing purposes. The 2" Pulleys 2 are connected by $\frac{1}{2}$ " Bolts but are spaced apart by nuts so that the Threaded Pin on the Strip 6 may easily pass between them. A Compression Spring is inserted between the Pulleys and the Collar carrying the $3\frac{1}{2}$ " Strips, and $1\frac{1}{2}$ " Strips are pivoted to the top Pulley 2 and to the Bell Cranks 4. The Strip 6 is pivoted to the Motor side plate and is provided with a contact stud (a Spring Buffer) 7.

A portion of the Rod 10 is covered with brown paper, stuck on with gum. A length of 27 B.I. Resistance Wire (part No. 312) is secured to the Collar 11 and is then laid on in a smooth spiral over the paper, and finished off a short distance from the top end of the paper. The Double-arm Crank 9 is insulated from the base and carries a terminal 12. Another terminal 13 is also insulated from the base and is connected to the Motor terminal 8, while the other Motor terminal is "earthed" by connecting it to the frame of the model. The Accumulator is connected to terminals 12 and 13.

If the speed of the Motor increases the governor weights 5 fly out and cause the Strip 6 to move up the resistance 3. If the speed increases beyond a certain limit—as may happen if the load on the Motor is suddenly

withdrawn—the contact 7 moves off the resistance on to the paper, thus breaking the circuit. If the speed decreases, owing to an increase in the load, etc., the contact 7 descends and decreases the resistance, and at its lowest point touches the Collar 11, when maximum current is supplied to the Motor.

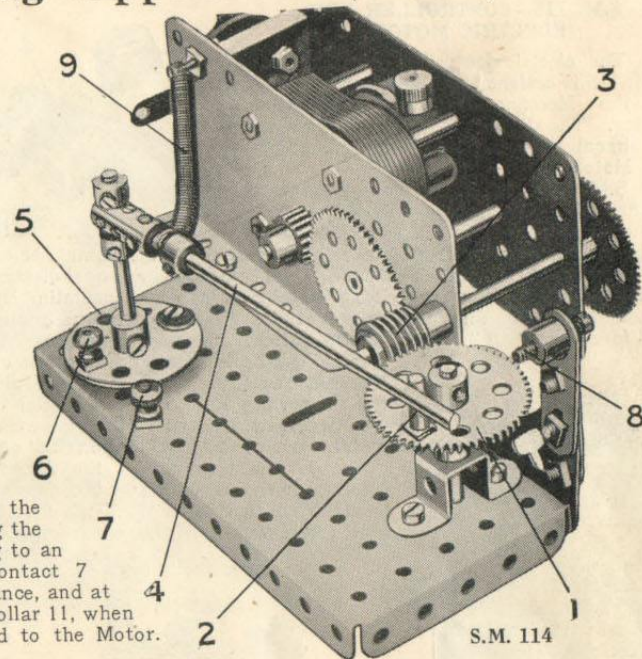
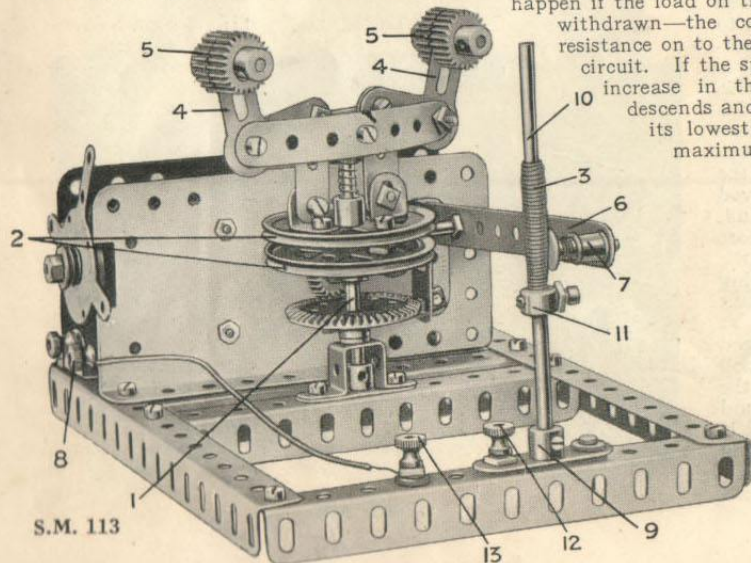

S.M. 114—AUTOMATIC SWITCH

The Motor in this device could be used to drive any Meccano model and the contact breaker used to light lamps, drive a secondary Motor, operate electro magnets, or to perform any other similar work at any pre-arranged intervals.

The 57-teeth Gear 1 meshes with a Worm 3 that is driven from the Motor. Rod 4 is mounted pivotally on a 2" Rod secured in the Bush Wheel 5, which is insulated from the base Plate by means of Insulating Bushes and Washers placed on 6 B.A. Bolts. The terminal 6 is mounted on the shank of one of these bolts.

A $\frac{3}{4}$ " Bolt 8 is mounted in a Threaded Crank, which is secured to a Corner Bracket that is insulated from the base Plate by 6 B.A. Bolts and Insulating Washers and Bushes. Normally the Rod 4 is held against Bolt 8 by a Spring 9, which is anchored to the Motor by an insulated 6 B.A. Bolt. As the Gear 1 rotates, the Threaded Pin 2 presses against the Rod 4, thus allowing current to flow from the terminal 6 along Rod 4, and back through the frame of the apparatus to the uninsulated terminal 7. When the Rod 4 comes to rest against the insulated stop 8, contact between the Rod and the Pin 2 is broken until the Pin, in moving round again touches the Rod.

Section VI. Brakes and Governing Appliances—(continued)

S.M. 115—CONTROLLER FOR ELECTRIC MOTOR

The electric controller illustrated in S.M. 115 is designed to regulate the speed of the Meccano low-voltage Electric Motor. The device may be incorporated in almost any model that is driven by the Motor.

S.M. 115 shows the complete unit connected to the Motor while S.M. 115A shows the controller dismantled. The resistances are formed from a length of Spring Cord, which must be opened out so that none of the coils are in contact. The Spring Cord is attached at equal distances to six B.A. Bolts 1, which are insulated from the Bush Wheel 2 by means of Insulating Bushes and Washers. The heads of the bolts form the contact studs. The seventh stud 3 is not connected in any way and forms the "off" position of the switch. The switch arm consists of a Double Arm Crank 4 carrying a Spring Buffer 5, the head of which presses lightly on the contact studs. The switch arm pivots on the upper end of the supporting Rod 6 and is retained in place by a Collar 7.

One of the Motor terminals is earthed by connecting it to the metal frame of the model, whilst the other terminal is connected direct to one terminal of the Accumulator. The remaining terminal of the Accumulator is connected to the terminal 8 which is mounted on the shank of the first contact stud. In order to limit the movement of the switch arm, a stop 9 consisting of a portion of a Spring Buffer is bolted to the Bush Wheel 2.

When the contact 5 is pressing on the contact stud 3, no current is supplied to the Motor. If the controller handle is moved to the next contact stud, the current must pass through the whole of the resistance before reaching the Motor, with the result that the latter runs at minimum speed. Speed can now be increased gradually by moving the contact 5 further round the Bush Wheel, until it reaches the stud carrying terminal 8, when maximum current is supplied to the Motor.

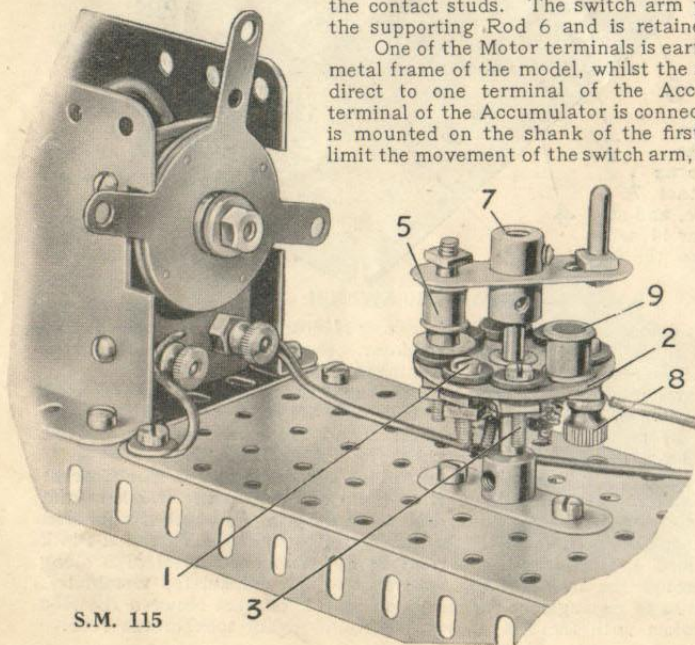

S.M. 115

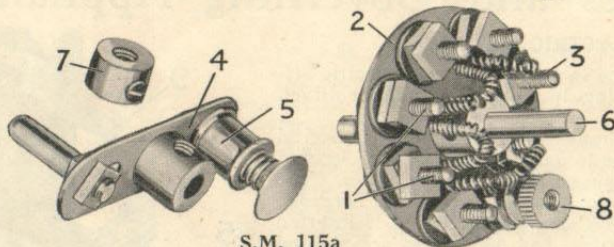

S.M. 115a

S.M. 116—AUTOMATIC SAFETY DEVICE FOR LIFTS

S.M. 116 shows an automatic locking device designed to prevent serious damage in the event of breakage of a lift hoisting cable.

Two Pawls 7 are secured to 2" Rods, which are journaled in 1" x 1" Angle Brackets 8. These Brackets are secured to the top of the lift by four 1" x 1/2" Angle Brackets 9, while Double Brackets 10 serve to strengthen the whole construction.

The hoisting cord 4, which may be controlled by any suitable machinery, is divided in two and connected to the set-screw of each Pawl 7. A piece of Spring Cord 11 secured between the Pawls tends to retain them in a horizontal position. When the cord 4 takes the weight of the lift, however, the Pawls are pulled downward and their ends brought clear of the Angle Girders 1. If the hoisting cord breaks the Spring 11 returns the Pawls to their original position, with the result that their ends engage the holes in the Girders 1 and the cage, instead of falling to the bottom of the shaft, becomes firmly locked in position.

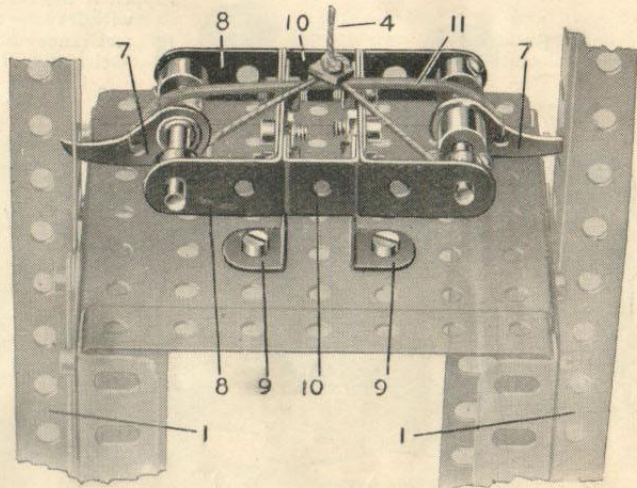

S.M. 116

Section VII. ROLLER AND BALL BEARINGS, Etc.

S.M. 131—BUILT-UP ROLLER BEARINGS

Where a heavy mass is to be rotated about an axis, it is necessary to devise some method of relieving the tremendous strain that would be imposed upon that axis. The usual procedure is to distribute the weight of the mass over wheels or rollers arranged at a distance from and rotating round the central pivot.

Standard Mechanism No. 131 is an excellent illustration of the type of roller, or wheel, bearings frequently used for the rotation of large cranes, revolving bridges, and other heavy structures. The lower, or stationary guide rails 1 are constructed from eight Channel Segments, and form a track upon which the wheel race 2 revolves. The fixed guide is shown in detail in S.M.131A; it will be noted that the Channel Segments are bolted to the base by means of $1" \times \frac{1}{2}"$ Angle Brackets 3. The Sprocket Chain 4 shown in this

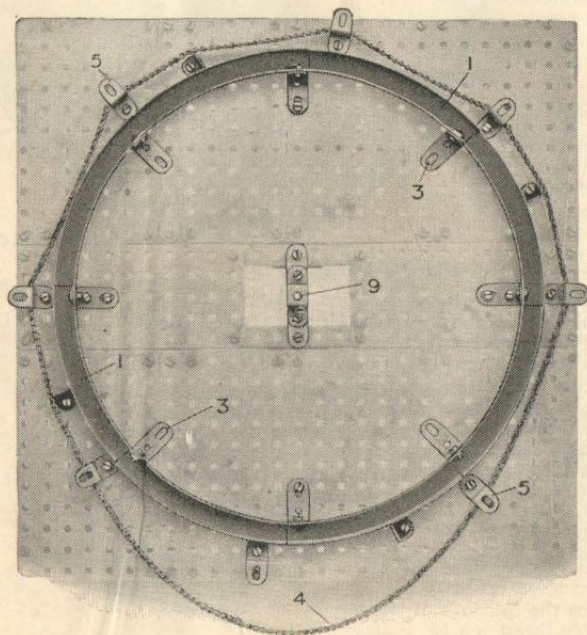

S.M. 131a

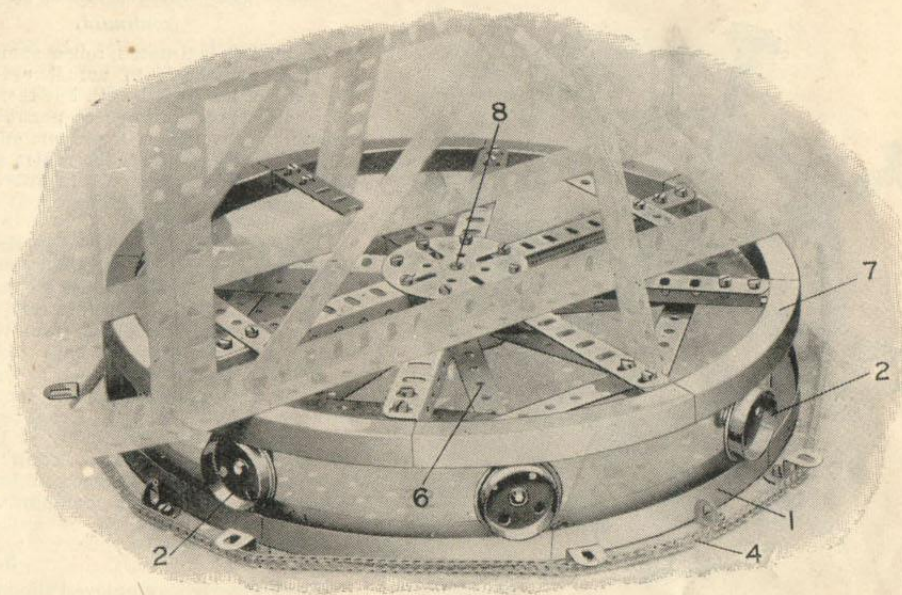

S.M. 131

figure illustrates a method of rotating the crane jib or other structure of which the track 1 forms the base; a vertical driven rod situated on the rotating structure carries a Sprocket Wheel placed *within* and engaging the chain loop 4. The latter is arranged round the series of Angle Brackets 5. On rotation of the Sprocket Wheel, the chain 4 tends to grip the brackets and becomes immovable, whereupon the Sprocket commences to travel *round the chain*, carrying the pivoted structure with it.

Eight Flanged Wheels forming the wheel race are mounted by means of $1\frac{1}{2}"$ Double Angle Strips to the spider-frame 6 (S.M. 131b). The revolving guide rail 7, shown in detail in S.M. 131c, is secured to the base of the upper or rotating part of the structure, and rests upon the wheels 2. A shaft 8 (S.M.131c) is journalled in the bearing 9 (S.M.131A) and forms a common axis for the spider-frame and revolving race 7, both of which rotate at different speeds. The shaft 8 should be secured in the Face Plate 10 forming the hub of the upper race 7, but the spider-frame 6 should be allowed to swivel freely upon it.

(Continued overleaf)

Section VII. Roller and Ball Bearings, etc.—(continued)

S.M. 131—Built-up Roller Bearings

(continued)

As already intimated, rollers sometimes take the place of wheels in actual practice. The rollers are of no great length but their diameters are usually made as large as possible, since an increase in size means a proportional decrease in friction. In addition, the rollers are tapered, as a rule, towards one end, in order that they shall describe a correct circle about the central pivot of the structure.

Rollers are also employed in smaller types of bearings, such as in shaft-journals, etc. Such bearings are similar in design and operation to the ordinary ball bearings (see S.M. 142), but the advantage obtained from the employment of rollers in place of balls exists in the fact that the surface of contact, or the area over which the strain is imposed, is increased considerably. Thus, in a journal-bearing, the rollers are placed longitudinally to the journal, and the latter is supported upon the entire length of each roller, whereas in ball bearings the contact surface is comparatively very small.

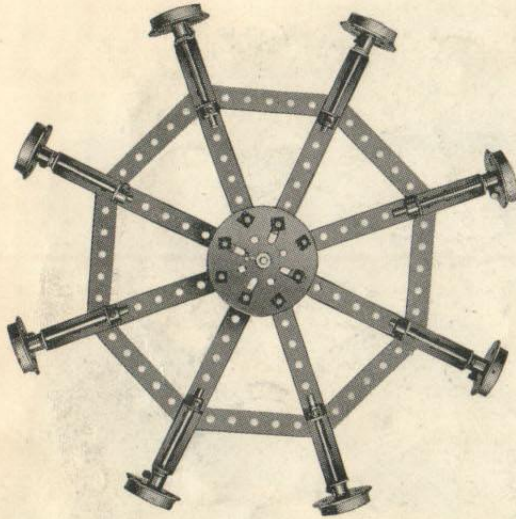

S.M. 131b

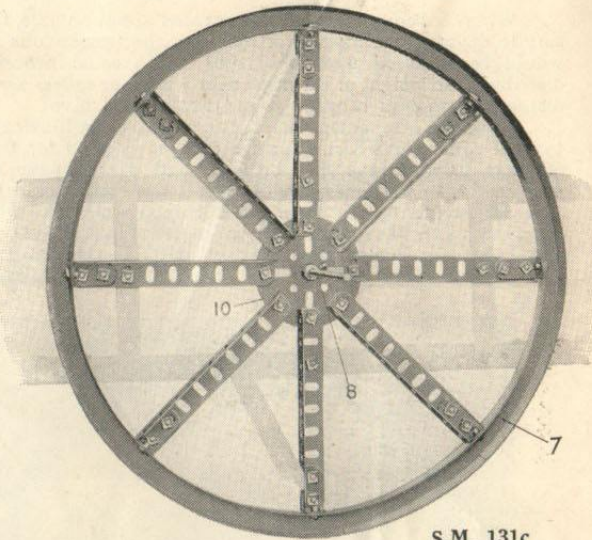

S.M. 131c

S.M. 132—KNIFE-EDGE BEARING

The knife-edge is employed almost universally in weighing-machines, balances, etc., where it is necessary to reduce friction in a moving lever to an absolute minimum. In the Meccano movement shown in S.M.132, the steel or agate prisms (or "knife-edges") are represented by two Centre Forks 1 secured in a Coupling 2 with their points resting between the teeth of two $\frac{1}{2}$ " Pinions 3 bolted to a short Rod rigidly held at either end in a Crank 4. The beam 5 is secured in the centre hole of the Coupling 2 and it will be noticed that the lever arms 6 and 7 are bolted in Couplings 8 at a lower level than the Coupling 2; the beam is shaped in this way in order to lower the centre of gravity at the fulcrum 1.

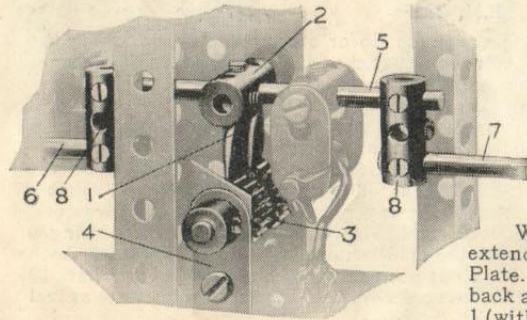

S.M. 132

S.M. 133—REINFORCED BEARING

Where a shaft is subjected to unusual pressure it is advisable to extend, or reinforce, the ordinary bearing afforded by a Meccano Strip or Plate. S.M.133 shows the method adopted to reinforce the bearings of the back axle of the Meccano Tractor. The axle is journaled through a $1\frac{1}{2}$ " Pulley 1 (with set-screw removed) securely bolted to the side plate 2. The recess cut in the boss of the Pulley to receive the set-screw forms a useful receptacle for oil when lubricating the axle.

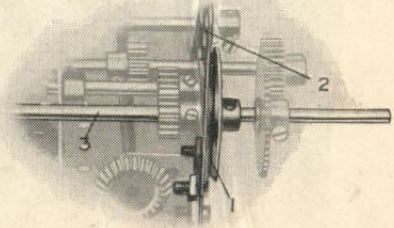

S.M. 133

Section VII. Roller and Ball Bearings, etc.—(continued)

S.M. 134—BUILT-UP BALL BEARINGS

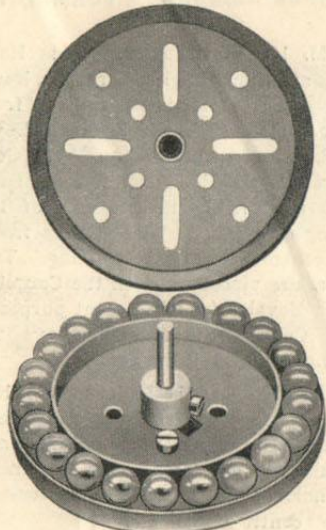

S.M. 134

This detail illustrates a built-up Meccano ball bearing. It is constructed from two 3" Pulley Wheels, one Wheel Flange, and twenty-one Steel Balls, and is applicable chiefly in models where a weight is required to impose vertically upon a pivot. The fixed ball-race is built up from the Wheel Flange and one 3" Pulley bolted together and secured to any suitable base. The balls are placed in the groove formed between the outer edges of this Pulley and the Wheel Flange, and the second Pulley, which should be bolted to the swivelling portion of the model, rests upon their upper surfaces. The lower Pulley is secured by its set-screw to the Axle Rod shown, while the other is allowed to turn freely. When the Pulleys are placed together, it is impossible for the balls to move out of position.

S.M. 135—BUILT-UP BALL BEARINGS APPLIED TO SWIVELLING CRANE

S.M.135 shows the jib of a small crane running on built-up ball bearings, such as described in S.M.134. The Rod 5, about which the jib pivots, is secured in the upper Pulley 1, which is bolted to the jib. The latter is rotated from the Crank Handle 8 by means of the Worm 7 engaging with the 57-teeth Gear Wheel 6 carried on the Rod 5.

The jib is secured to the base by a Collar bolted on the Rod 5 just beneath the platform. The worm gear ensures that the jib swivels only when required.

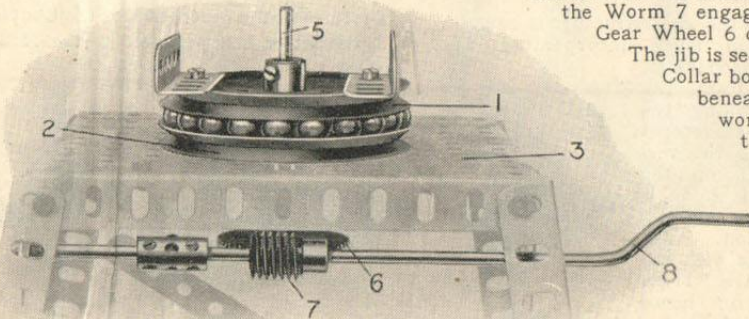

S.M. 135

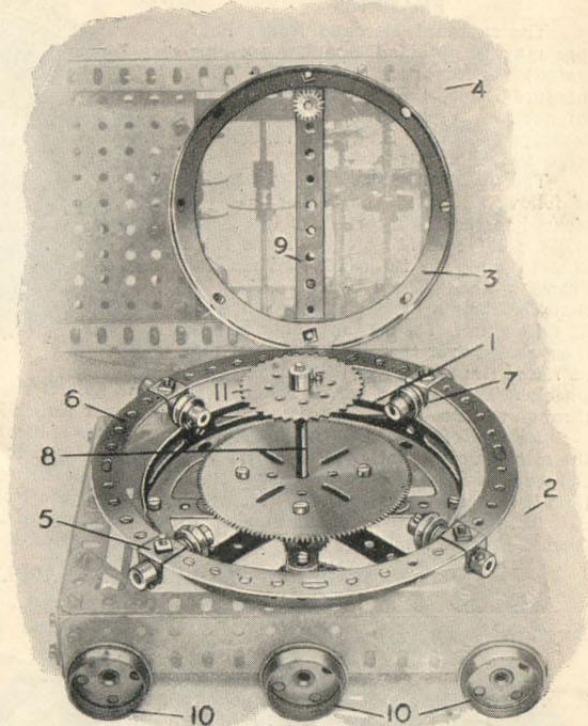

S.M. 136

S.M. 136—SMALL ROLLER BEARINGS

The swivel-bearing shown in this illustration is similar in principle to S.M.131, but is designed for lighter work. The Hub Disc 1 is bolted to the base 2 of the model and forms a guide upon which runs the wheel-race constructed from four 1/4" Pulleys 7, pivotally carried from a Circular Strip 6. A Circular Girder 3 bolted to the upper platform 4 of the model rests upon the Pulleys 7. The model pivots about the Rod 8, which passes through the Girder 9, but the weight of the rotating body is distributed over the Pulleys 7, so obviating the strain that would otherwise centre upon the pivot 8.

Section VII. Roller and Ball Bearings, etc.—(continued)

S.M. 137—STANDARD ROLLER BEARINGS

The standard Meccano Roller Bearings may be obtained complete (as illustrated) under part No. 167. They measure 12 ins. overall diameter and are intended to replace the built-up roller bearings shown in S.M. 131 in building large swivelling structures.

The Roller Bearings are assembled as follows: One of the Roller Races is secured to the fixed portion of the model and the $1\frac{1}{2}$ " Rod is fastened in the Bush Wheel bolted to its centre. The Ring Frame is then placed over the Race so that the flanges of the wheels run upon its raised rim. The second Roller Race is then placed over the Ring Frame so that its raised rim rests upon the flanges of the wheels. The $1\frac{1}{2}$ " Rod passes through the

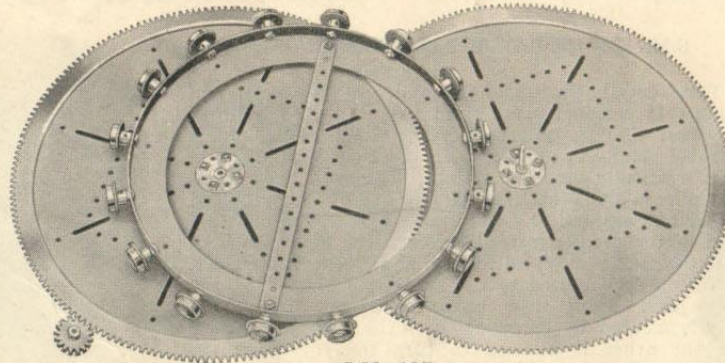

S.M. 137

centre hole of the $9\frac{1}{2}$ " Strip that is bolted across the Ring Frame, and through the Bush Wheel in the centre of the upper Roller Race.

Method of Rotation—If the driving mechanism is incorporated in the superstructure, a simple way to effect the rotation of the latter is to mount the special 16-teeth Pinion on a vertical driven Rod so that it engages with the teeth of the lower fixed Roller Race. The vertical Rod should be journaled suitably in the superstructure; then if it is set in motion, the Pinion travels round the Roller Race and carries the superstructure with it.

Alternatively, if the driving mechanism is in the fixed base of model, the Pinion should be secured to a Rod journaled in a vertical position in the base and caused to engage with the upper Roller Race.

S.M. 138—ROLLER BEARINGS APPLIED TO PONTOON CRANE

This shows a typical adaptation of the standard Roller Bearings. to turn round on the Flanged Wheels 1 on operation

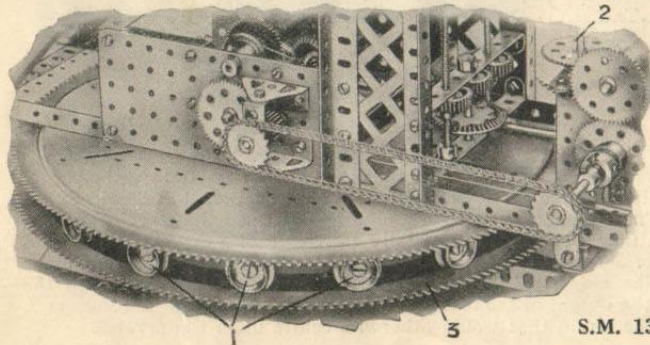

S.M. 138

In this case the superstructure is caused of a certain lever incorporated in the control mechanism.

The drive from the Motor controlling the rotational movement is directed to the vertical Rod 2, on the lower end of which is mounted the special 16-teeth Pinion. The latter engages with the teeth of the lower Roller Race 3; hence on rotation of Rod 2 the Pinion travels round the Roller Race, carrying the superstructure with it.

S.M. 139-141—BEARINGS FORMED BY COUPLINGS

S.M. 139 illustrates two Axle Rods driven at right angles through Bevel Gears. The power is transmitted from the Rod 1 through the 26-teeth Bevel Gear 2, to a corresponding Bevel Gear 3 secured to the Rod 4. One end of the Rod 1 runs freely in one end of the Coupling 6, while the Rod 4 runs freely in the centre hole of the Coupling. Two Washers are placed between the Coupling and the Bevel 3 for adjustment purposes, and a Collar 5 is secured above the Coupling to hold it in position.

S.M. 140.—This is similar to S.M. 139, with the exception that 26-teeth and 48-teeth Bevel Gears are employed and the Axle Rod 4 rotates in the end transverse hole of the Coupling 2 instead of in the centre hole.

S.M. 141.—In this example the Axle Rod 1 is stationary, whilst the Axle Rod 2 rotates in the centre hole of the Coupling 3, the latter being secured to the Rod 1.

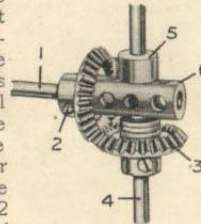

S.M. 139

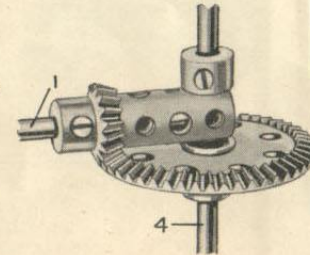

S.M. 140

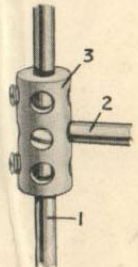

S.M. 141

Section VII. Roller and Ball Bearings, etc.—(continued)

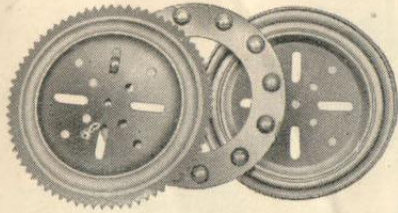

S.M. 142—STANDARD BALL BEARINGS

The illustration shows the standard Meccano Ball Bearing Unit (part No. 168), with the aid of which a structure may be turned about a central pivot freely and in a steadier manner than is possible with ordinary bearings. It is in three sections, namely, one Flanged Ball Race, one Geared Ball Race, and the Ball Casing complete with Balls. For the method of securing and operating the unit see S.M. 143 and 144.

S.M. 143—BALL BEARINGS APPLIED TO SWIVELLING CRANE

This shows the application of S.M. 142 to a small crane. The Flanged Ball Race 1 is secured by bolts to the $5\frac{1}{2}'' \times 2\frac{1}{2}''$ Flanged Plate 2, and the Geared Ball Race 8 is fastened to the swivelling structure. The Ball Casing is placed between these two parts so that the Flanged Ball Race rests upon the Balls. Hence the weight of the structure rests entirely upon rolling surfaces, with the result that friction is reduced to a minimum. A short Rod passed through the centre of the Ball Races 1 and 8 and maintained in its position by Collars, holds the unit together.

The superstructure is rotated by means of a Sprocket Chain passing round the teeth of the Geared Ball Race 8 and engaging a 1" Sprocket Wheel 3 which is secured to a Rod 4. At the bottom of the latter is a 57-teeth Gear Wheel 5 that is operated on rotation of the Worm on the Rod 6 of the hand wheel 7.

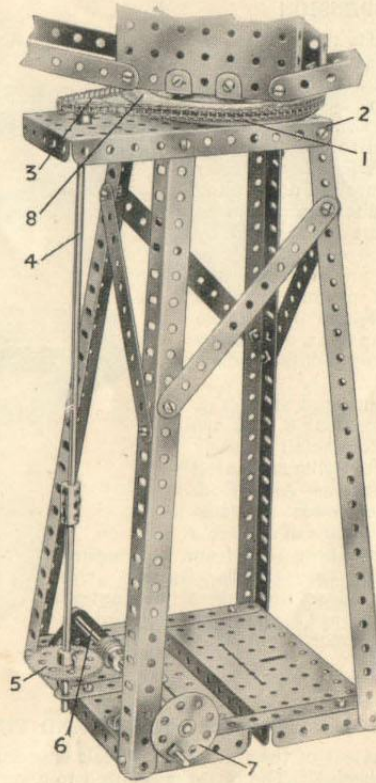

S.M. 143

S.M. 144—BALL BEARINGS APPLIED TO MECHANICAL DIGGER

This illustrates another example of the use of the Meccano Ball Bearing unit. It is shown applied to a model mechanical digger and in this case the Flanged Ball Race rests upon the Balls instead of the Geared Ball Race as in S.M. 143. In the illustration the Flanged Ball Race 1 is shown lifted clear of the Balls. Also, spur gearing is employed to rotate the superstructure instead of Sprocket Chain mechanism as in S.M. 143. The $3\frac{1}{2}''$ Gear Wheel 2, which replaces the Geared Ball Race, is secured to Girders 3 in the travelling base of the model by four $\frac{1}{4}''$ Reversed Angle Brackets 4. The $\frac{1}{2}''$ Pinion 5, which is secured to a Rod that is driven by any suitable means from the motive power carried on the superstructure, engages with the Gear Wheel 2 and thus effects the swivelling movement.

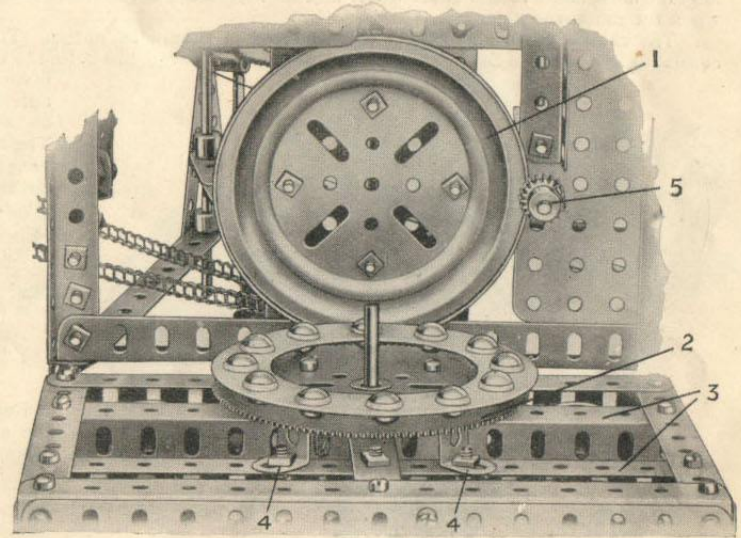

S.M. 144

Section VIII. STEERING GEAR

S.M. 161—MOTOR CHASSIS STEERING GEAR AND SPRING SUSPENSION

This is a very interesting model of "Ackermann" steering mechanism, and is shown fitted to a Meccano motor chassis. The steering wheel shaft, which may be situated at any convenient angle to the horizontal, rotates the Contrate Wheel on the Rod 2, by means of a $\frac{1}{2}$ " Pinion. An alternative method of connection may be employed, consisting of a Worm Wheel engaging with a 1" Gear Wheel or Pinion mounted on the shaft 2. The latter carries a Crank 3 pivotally attached to a bolt gripped in a Collar on a further Rod 4. A Coupling bolted to the other end of this Rod 4 is pivotally connected in a similar manner to the end of the short Rod 5, the outer end of which forms the bearing for one of the road wheels. This Rod 5 is secured in a Coupling 9 mounted on a 1" Rod journalled in a Crank 10. The latter is bent slightly as shown and secured to a reinforced cross-bar 8. The further road wheel 6 is connected to the first road wheel by means of a Rod 7, which is carried pivotally from the shanks of long bolts secured in Collars on short Rods mounted in the Couplings 9. In actual practice these short rods are situated at a slightly obtuse angle to the axles, in such a position that their centre lines, if produced, would meet on the centre line of the car. The actual meeting-point, as a rule, is slightly in advance of the rear axle. This slight difference of angle in the small levers invariably imparts a decreasing angular movement to the outer wheel and an increasing angular movement to the inner wheel when the car turns a corner.

The chassis springs shown in this illustration should be noted. The laminated springs 1, consisting of a series of Strips of varying sizes slightly curved, are bolted to the cross-bar 8, and are pivotally connected at their outer ends to Collars mounted on a transverse Axle Rod. Their other ends are suspended by means of a Double Bracket and short Rod from a Coupling pivoted to the chassis frame; this connection allows for lateral movement when the springs are flattened by sudden jolts, or shocks, imparted from the road wheels.

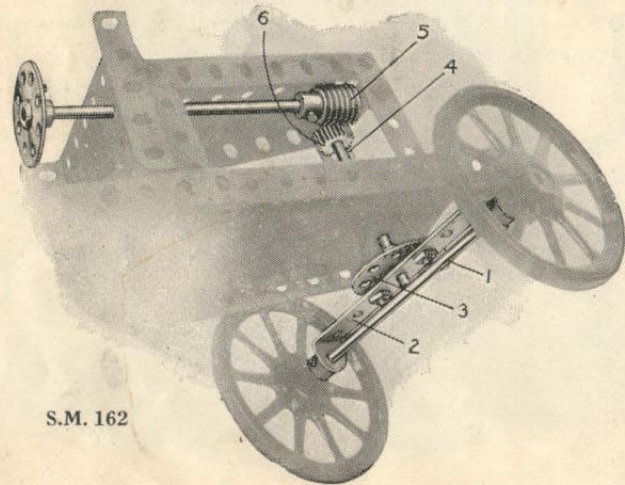

S.M. 162

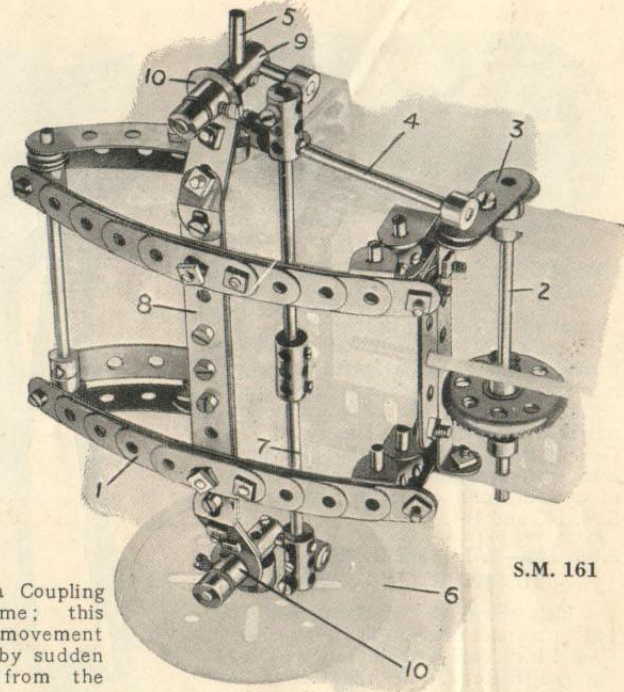

S.M. 161

S.M. 162—WORM AND PINION STEERING GEAR

The axle 1 of the front road wheels is journalled in a $3\frac{1}{2}$ " Double Angle Strip 2 bolted to a Bush Wheel 3. The latter is secured to a vertical shaft 4, which also carries a $\frac{1}{2}$ " Pinion 6. On operation of the steering wheel, the shaft 4 is rotated by means of the Worm Wheel 5 engaging the Pinion 6, consequently altering the position of the road wheels as desired.

This gear will be found very useful in constructing small models of motor cars, trucks, etc. The road wheels cannot be deviated from the line in which they are set unless the steering wheel itself is turned.

In another form of Worm and Pinion steering gear the shaft of the Pinion is journalled horizontally and carries a Crank or steering lever that is connected to stub axles arranged in a similar manner to that described in S.M. 161.

Section VIII. Steering Gear—(continued)

S.M. 163—STEERING GEAR

The axle 2 is carried from a Double Angle Strip 1 bolted to a Bush Wheel, as in S.M. 116, but is rocked about its pivot by means of a connecting Strip 3. The latter is pivoted at 7 to the Strip 1 by means of bolt and nuts (see S.M. 262) and at the other end 6 to a Crank 4 secured to the steering shaft 5.

Double Bent Strips form extended bearings for both the steering-column, and short Rod about which the Bush Wheel and Double Angle Strip 1 pivot.

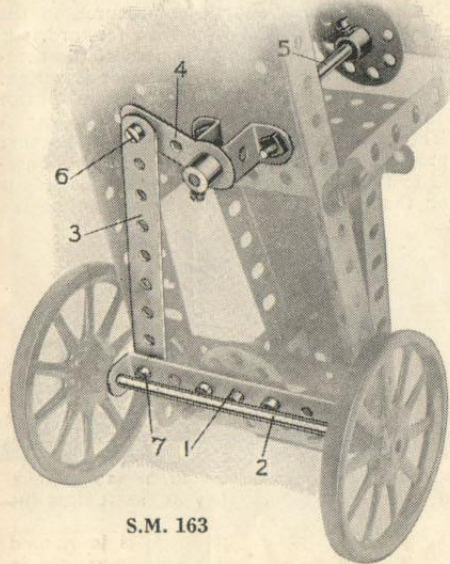

S.M. 163

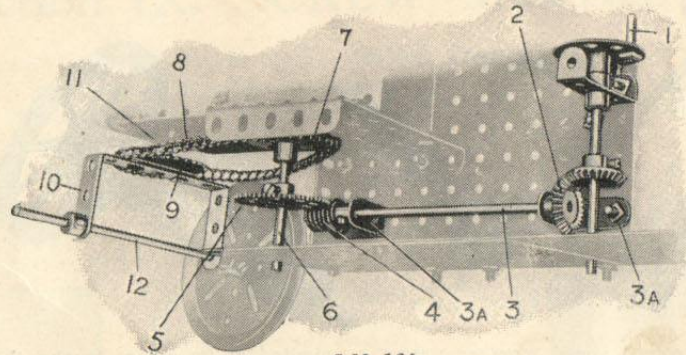

S.M. 164

S.M. 164—STEERING GEAR FOR TRACTOR

This type of steering gear is particularly suitable for use in model road tractors, etc. The hand wheel 1 rotates by means of Bevel Gears 2 a horizontal shaft 3 journalled in 1" x 1" Angle Brackets 3a. The shaft 3 carries a Worm Wheel 4 engaging with a 57-teeth Gear Wheel 5 on the vertical Rod 6. The 1½" Sprocket Wheel 7 secured to this Rod engages, through a Sprocket Chain 8, a similar Sprocket Wheel 9 bolted to the Double Angle Strip 10 and carried from a short Axle Rod 11 journalled in suitable bearings in the front of the tractor. The Strip 10 forms bearings for the axle 12 of the front road wheels. Washers should be placed on the bolts between the Sprocket 9 and Strip 10, in order to allow sufficient clearance for the Chain 8.

Several alternative methods of construction may be employed. For example, the Rod 6 may be placed in a horizontal position and a short length of chain wound upon it so that, as one end is hauled in, the other is paid out (see S.M. 166). The two ends of the chain are secured to the extremities of the Double Angle Strip 10.

S.M. 165—STEERING GEAR

The method adopted in guiding the road wheels in this model is as follows: the steering shaft 1 operates, through a Contrate gear 2, the cross Strip 3 bolted to a Crank secured to the vertical Rod 4. Cords 5 lead from the ends of this cross Strip to the ends of a Double Angle Strip 6 pivoted by bolt and nuts (S.M. 262) to the Double Bent Strip 7 and carrying the axle 8 of the road wheels.

It will be noted that the steering-shaft 1 is mounted at an obtuse angle to the Rod 4.

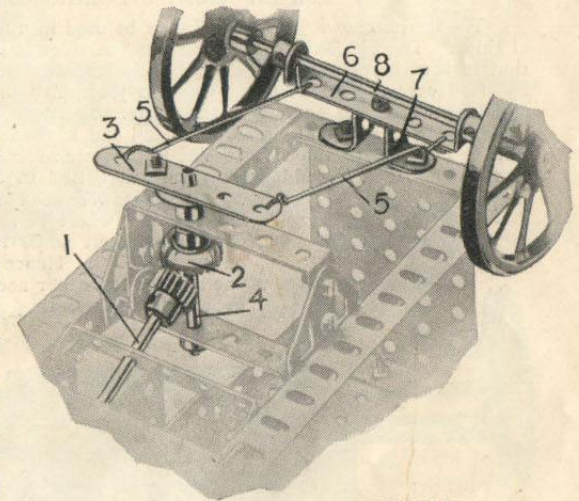

S.M. 165

Section VIII. Steering Gear—(continued)

S.M. 166—WORM AND CHAIN STEERING GEAR FOR TRACTOR

S.M. 166 shows an alternative form of steering gear to S.M. 164 for traction engines, etc. The steering wheel 1 is secured to a Rod 2 of any convenient length, and the Rod is journalled in Double Brackets bolted to the side frame plate of the tractor. It carries at its lower end a Worm engaging a $\frac{3}{4}$ " Pinion 4 on a Rod 5. This Rod 5 carries several Couplings and Collars, the heads of the grub screws of these serving to grip a 16" length of Sprocket Chain 6 that is wound round the Couplings five or six turns and thence passed round the 2" Sprocket Wheel attached to the front axle. The ends of the chain are of course joined together. By reason of this arrangement the front wheels may be directed either to right or left according to the direction in which the steering wheel is turned.

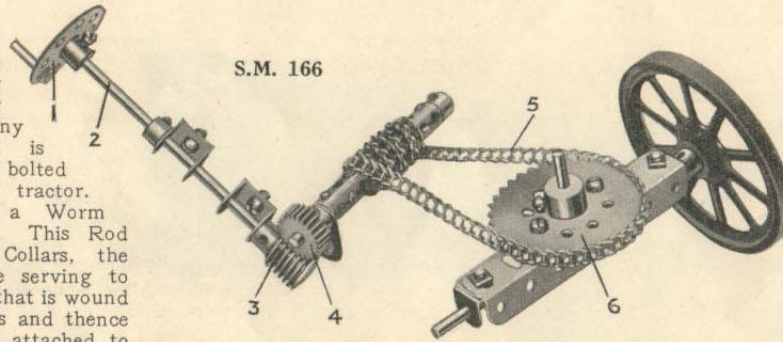

S.M. 166

S.M. 167—BOAT STEERING GEAR

The device shown in S.M. 167 may be used in numerous Meccano models of ships. The $5\frac{1}{2}$ " Strip that represents the tiller is bolted to a Bush Wheel that in turn is secured to the top of the Rod that carries the rudder. The $3\frac{1}{2}$ " Rod carrying the steering wheel is journalled in a Double Angle Strip and in a Trunnion secured to the Plate. A length of cord is taken round the steering rod several times, and each end is then passed over the 1" fast Pulleys and tied to the tiller. The Pulleys are secured to $\frac{3}{8}$ " Bolts journalled in Double Brackets, which, in turn, are bolted to $5\frac{1}{2}$ " Strips as shown.

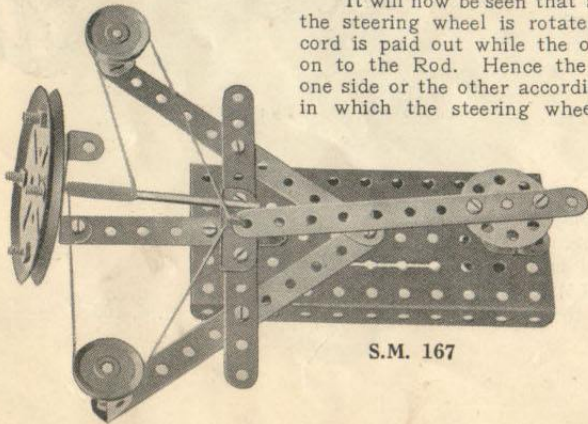

S.M. 167

It will now be seen that as the Rod carrying the steering wheel is rotated, one end of the cord is paid out while the other end is wound on to the Rod. Hence the tiller is pulled to one side or the other according to the direction in which the steering wheel is turned. The steering wheel may be placed quite conveniently on the bridge of a model ship and the cords taken to the tiller through suitable guides fixed to the deck or inside the hull.

S.M. 168—AEROPLANE CONTROL GEAR

S.M. 168 illustrates a typical control gear that may be embodied in the majority of Meccano aeroplanes.

The Meccano controls are mounted together on a $2\frac{1}{2}$ " x $2\frac{1}{2}$ " Flat Plate for convenience in fixing them in the fuselage of a model. The joystick 1 is a $1\frac{1}{2}$ " Rod held in the boss of a Swivel Bearing. The collar of the latter is secured to a 3" Rod 2 which is journalled horizontally and carries a Coupling 3. A $\frac{1}{2}$ " loose Pulley 4 is journalled on a $\frac{3}{4}$ " Bolt secured to the plate by two nuts, and is retained in position by means of a Collar. The rudder bar 5 consists of a $2\frac{1}{2}$ " Strip

pivoted at its centre to the Flat Plate.

The wire 6 is fastened at one end to a short lever secured at right angles to the under surface of the elevator; it is then attached to the joystick 1, led round the Pulley 4 and back to another short lever secured to the upper side of the elevator. Hence, when the stick is pushed forward, the elevator moves downward from its hinge, thus sending the nose of the aeroplane downward. When the stick is pulled back the elevator is raised.

The wire 7 is secured at its centre to the Coupling 3 and its ends, after being led round guide pulleys, are fastened to short levers projecting at right angles from the ailerons. The latter are connected together by another wire attached to further levers projecting from their opposite sides. Consequently, when the stick is moved to the left the aileron on the right side is pulled down, causing the wing on that side to rise. At the same time the aileron on the left side is pulled up, assisting the downward motion of the left wing and the machine banks. When the lever is pushed to the right, the reverse takes place. In a biplane, the aileron on each lower wing is connected by wires to the corresponding aileron on the upper wing, so that all the ailerons move simultaneously.

The ends of the rudder bar 5 are connected by wires 8 to levers projecting on opposite sides of the rudder, with the result that the rudder can be moved right or left by pushing the lever with either the right or left foot.

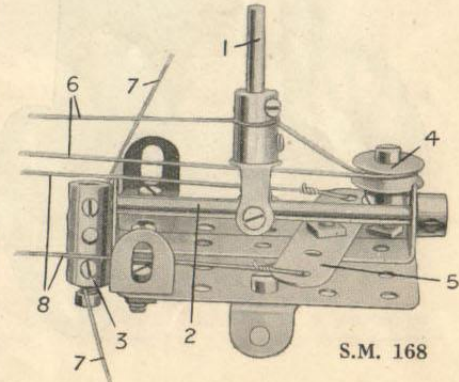

S.M. 168

Section IX. SCREW MECHANISM

The Threaded Rod is one of the most useful features of the Meccano system ; it readily lends itself to a wide variety of ingenious movements, and, as will be seen from the examples included in this section, it enables some very important mechanical movements to be reproduced with detailed accuracy. It also proves invaluable as a method of increasing the available power, although at a considerable loss of speed, in order to cope with exceptionally heavy loads.

S.M. 181—SCREW GEAR, OPERATING JIB OF CRANE

The Threaded Rod 1 passes through the central threaded bore of a Coupling 2, which is pivotally carried from the jib 3 on short Rods 4. The jib, in turn, is pivoted at 5 to the base 6.

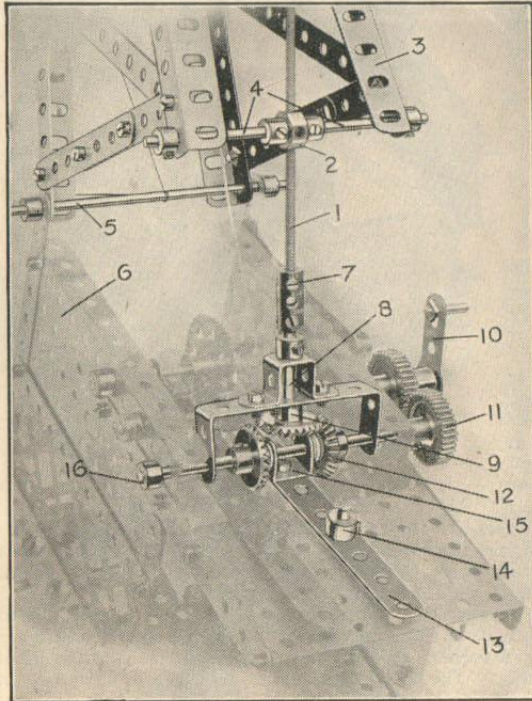

S.M. 181

The Rod 1 is secured in a Threaded Coupling 7 bolted to a short Rod 8 ; and the Bevel Wheel 9 on the latter is rotated from the operating handle 10 through 1" Gear Wheels 11 and bevel reversing gear 12 (see S.M. 66). The reverse is effected on operation of a lever 13 pivoted at 14 and bolted to a Double Bracket 15, which is carried on the shaft 16 and spaced by Washers between the two Bevel Wheels. The jib 3 is caused to rise and fall according to the direction of rotation of the Threaded Rod 1.

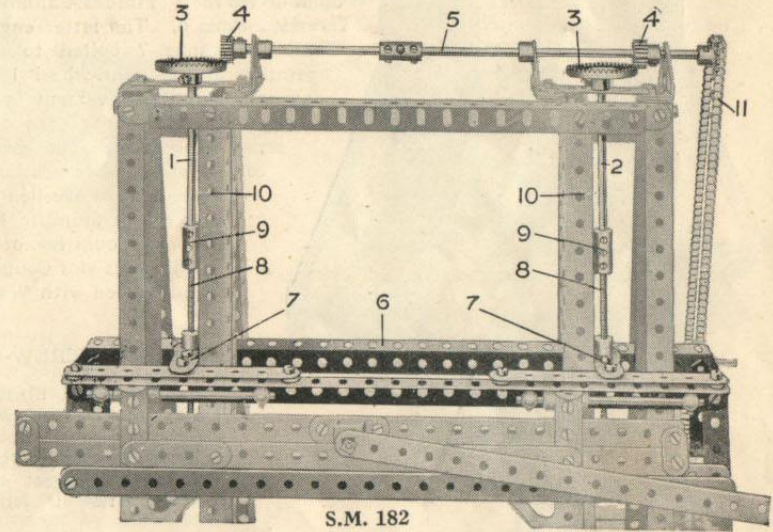

S.M. 182

S.M. 182—APPLICATION OF SCREW GEAR IN TRAVERSING MECHANISM OF MACHINE TOOLS

This detail shows a section of the Meccano Log Saw (Model No. 6.21). In this model Threaded Rods have been employed to adjust the position of the saw, in order that the logs may be cut in sections of any desired thickness.

A vertically adjustable frame 6, which carries the saw, slides on the upright members 10, and is operated from the Threaded Rods 8. These engage with the Threaded Cranks 7 bolted to the frame, and are connected at their upper ends to Axle Rods 1 and 2 by Couplings 9. Rods 1 and 2 are rotated simultaneously from the horizontal shaft 5 by means of 1½" Contrate Wheels 3 and ½" Pinions 4 ; and the frame 6 is raised or lowered according to the direction of rotation of the vertical Threaded Rods.

The shaft 5 is connected by Sprocket Chain 11 to a hand-wheel conveniently situated in the base of the model.

Section IX. Screw Mechanism—(continued)

S.M. 183—HOISTING GEAR OF CRANE DRIVEN BY SCREW MECHANISM

The hand-wheel 1 rotates a Contrate Wheel 2, secured to a shaft 2A, carrying a 57-teeth Gear Wheel 3 which drives the $\frac{1}{2}$ " Pinions 4 and 5 secured to the vertical Threaded Rods 6. The latter engage the bosses of two Threaded Cranks 7 bolted to a Bush Wheel 8. On operation of the hand-wheel 1 the Rod 9 is raised or lowered, and its movement is employed to draw in or pay out the hoisting cord of the crane by means of a series of Pulleys. The method by which the hoisting cord is operated is similar to that adopted in hydraulic cranes, and an excellent representation of the necessary gear will be found in Model No. 7.4 (Hydraulic Crane). It should be noted that the Rod 10 is journaled in the end of a Coupling 11 which is loosely mounted and spaced with Washers on the Rod 2A.

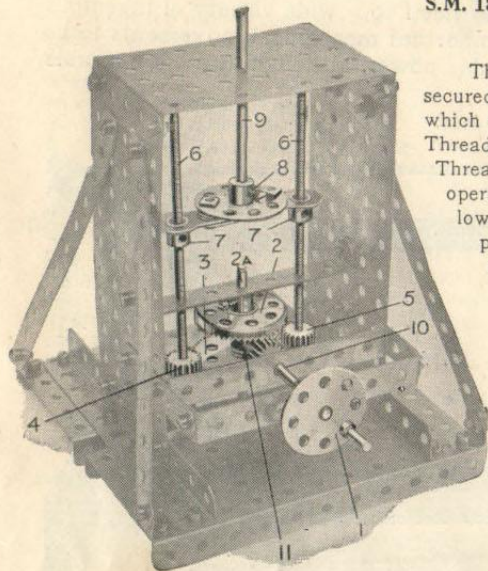

S.M. 183

S.M. 185—LATHE TOOL ADJUSTING DEVICE

The Threaded Rod 1, journaled in a Double Angle Strip 2 and held in place by a Collar 3, is rotated by the hand-wheel 4. The tool post 5 is secured to a Threaded Pin 6, which is screwed into a Threaded Boss 7 engaging the Rod 1. Consequently rotation of the hand-wheel causes the tool post to travel to and fro. Two $2\frac{1}{2}$ " Strips on the lathe saddle are bolted between the $1\frac{1}{2}$ " Strips 8 and form guides on which further $1\frac{1}{2}$ " Strips 9 are allowed to slide. The $2\frac{1}{2}$ " Strip 10 secured to the tool post slides between the $1\frac{1}{2}$ " Strips 8.

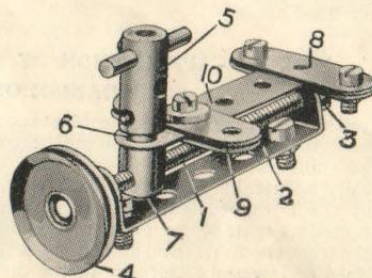

S.M. 185

S.M. 184—SCREW-OPERATED JIB-RAISING GEAR

This detail illustrates a method by which Screw Gear may be employed in elevating the jib of a heavy crane, or similar work, and incidentally forms a very fine model of the type of gear used in the majority of the world's largest cranes.

The drive is led by way of the $1\frac{1}{2}$ " Bevel Gear 1 and 1" Gear Wheel 2 secured to a short Rod to further

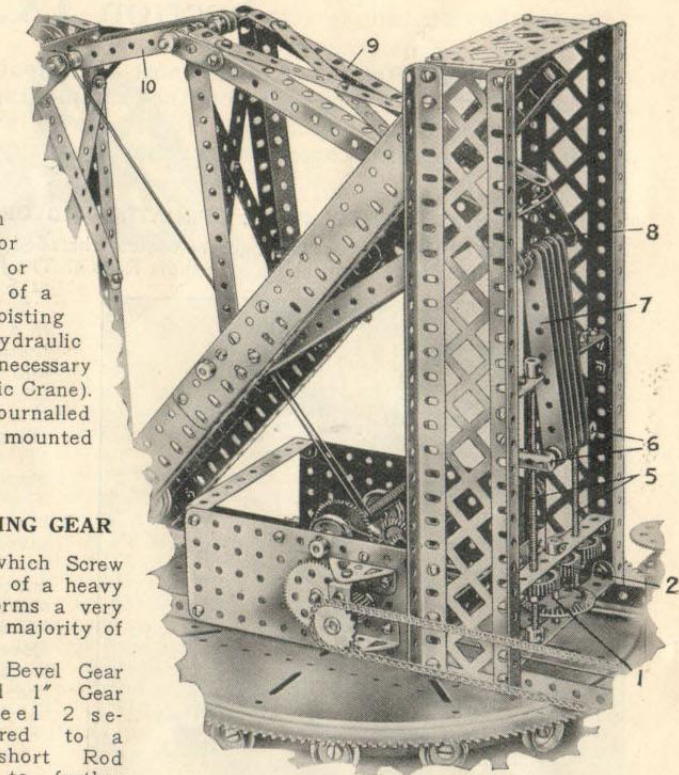

S.M. 184

Wheels carried on the vertical Threaded Rods 5. The latter engage the threaded borings of two Couplings 6, and as they rotate these Couplings are forced slowly up or down. The links 7, pivotally attached at their lower ends to a Rod secured between the Couplings 6 and at their upper ends to a Rod 8, transmit this movement to levers 9 which in turn are pivotally attached by a further series of links 10 to the jib of the crane. The jib is therefore raised or lowered in consequence of the movement of the Couplings 6.

Section IX. Screw Mechanism—(continued)

S.M. 186—ADJUSTING AND LOCKING DEVICES

S.M. 186 shows a screw adjustment fitted to the tail-stock of a lathe. The Threaded Rod 1 engages the boss of a Threaded Crank 2, bolted to the tail-stock 3 which slides between Angle Girders 4. The tail-stock is guided by means of a Double Angle Strip, bolted to its underside, engaging the Rod 5. The Threaded Rod 1 is secured by a Coupling 6 to the Rod 7, and is rotated by a hand-wheel 8.

The tail-stock is locked in position on turning the Threaded Boss 9, which engages the shank of a bolt passed through a $1\frac{1}{4}$ " Strip placed transversely beneath the Girders 4. As the Threaded Boss turns, the bolt presses against this $1\frac{1}{4}$ " Strip and causes it to grip the Girders 4, so holding the tail-stock rigidly in position.

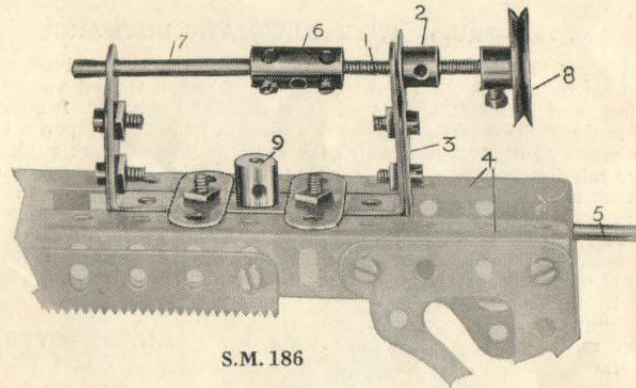

S.M. 186

S.M. 187—LOCKING DEVICE

This illustrates a method by which the table of a drilling machine, or similar apparatus, may be quickly and rigidly locked, in any position. The table 1 is bolted to a Crank 2 sliding on a vertical shaft 3. A $\frac{3}{4}$ " bolt 5 is inserted in the boss of the Crank, and carries a Collar 6 which is held in place on the bolt by a nut 7. The table is locked in the desired position by twisting the bolt 5 until it nips the shaft 3; a suitable handle is provided by a Threaded Pin 8 inserted in the Collar 6.

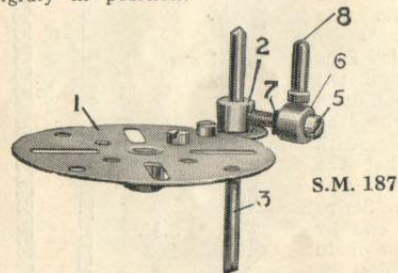

S.M. 187

S.M. 188—SCREW ADJUSTMENT

The Threaded Rod shown in this illustration is employed to adjust the elevation of a machine gun. The rod, engaging a Threaded Crank bolted to the swivelling base, passes through a Flat Bracket on the gun, and is held in place by two Collars. The adjustment is effected by rotating the $\frac{1}{2}$ " Pin shown.

S.M. 188

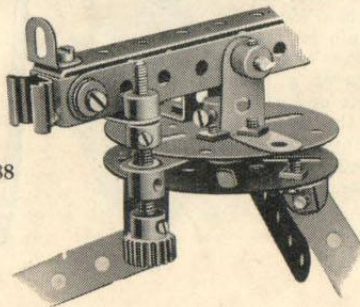

S.M. 189—SCREW ADJUSTMENT

Here the Threaded Rod is employed as a device for adjusting the table of a drilling or boring machine, etc. The table 1 is bolted to a Threaded Crank 2, the boss of which engages the vertical Threaded Rod 3. The latter carries a Pinion 5, which gears with the Worm Wheel 4 on the shaft of the hand-wheel 6. $2\frac{1}{2}$ " Angle Girders 8 bolted to the table and connected by a Double Bracket 7 slide upon the vertical Girders 9, and form guides to hold the table in position.

The table is raised or lowered according to the direction of rotation of the hand-wheel.

Note.—Where a Threaded Rod is required to rotate in bearings, it should be first connected by Couplings to ordinary Axle Rods, if possible, so that the latter may be journaled in the bearings instead of the Threaded Rod; it will be found that this results in better and smoother working.

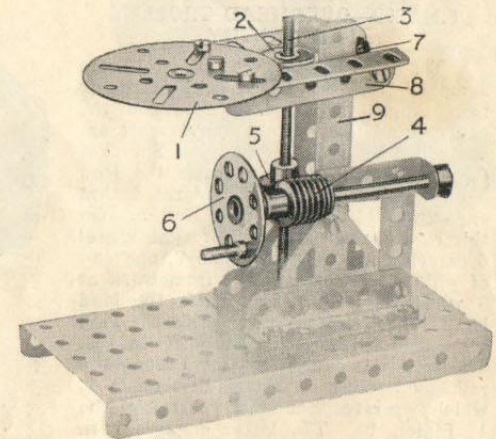

S.M. 189

Further examples of SCREW MECHANISM will be found in S.M. 105 and 106, (Section VI).

Section X.

OVERHEAD TROLLEYS & TRUCKS FOR GANTRIES, ETC.

S.M. 201—TRUCK, WITH AUTOMATIC DISCHARGE

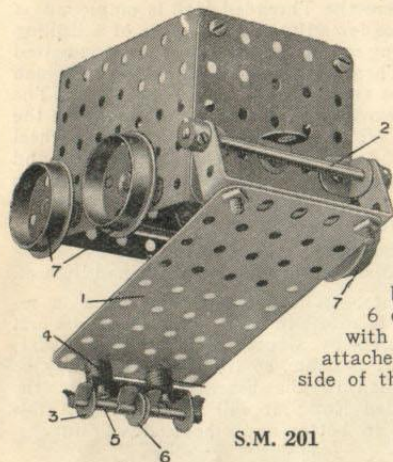

The $4\frac{1}{2}$ " \times $2\frac{1}{2}$ " Flat Plate 1, forming the bottom of the truck, pivots about the Rod 2, and carries a short Double Angle Strip 3, which is spaced away from the Plate by means of five Washers placed on each of the bolts 4. A short Rod 5 journalled in the Strip 3 carries a $\frac{1}{2}$ " loose Pulley 6, which runs upon a third rail laid in the centre of the track on which the Flanged Wheels 7 are guided. This centre third rail dips down the side of a chute placed beneath the truck runway, with the result that, on the truck reaching this spot, the bottom plate 1 falls open, since the Pulley 6 is no longer supported, and the contents of the truck are discharged. As the truck returns for a fresh load, the Pulley is forced up the sloping end of the centre rail, until the bottom of the truck is again closed. If desired the truck may be made to continue in the same direction after discharging, the bottom being closed by Pulley 6 coming into contact with a sloping rail attached to the far side of the chute.

S.M. 201

S.M. 202—OVERHEAD TROLLEY FOR GANTRY

The $\frac{3}{4}$ " Flanged Wheels 1, 1a are arranged to run on rails constructed from Angle Girders laid down on the gantry, and the various movements are controlled by hauling on endless Sprocket Chains. The chain 2 operates the Rod 3 on which is mounted a Worm 4 that engages a $\frac{1}{2}$ " Pinion on a Rod 5. On this Rod is secured a 1" Sprocket Wheel 6 carrying the hoisting chain 7, one end of which is secured to the framework at 8 while the other end carries the load hook. The Worm gear 4 holds the load suspended without the use of brakes. The trolley is caused to travel along the rails by hauling on the endless chain 9, which operates the Rod carrying the $\frac{1}{2}$ " Pinion 10. The latter engages with a Gear on the axle of the wheels 1a.

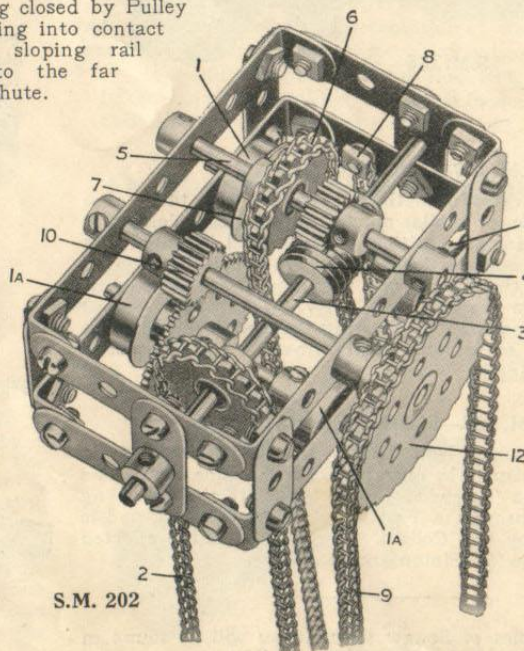

S.M. 202

S.M. 203—OVERHEAD TROLLEY, WITH CHAIN HOIST

S.M. 203 illustrates a device employed in many factories and workshops to facilitate the movement of heavy loads by hand power. The trolley runs upon overhead rails, and the load is raised by hauling upon an endless chain (represented by Sprocket Chain 27 in the model). It will be observed that the trolley is constructed from two $2\frac{1}{2}$ " \times $1\frac{1}{2}$ " Double Angle Strips bolted together at each end by two Flat Trunnions. The chain 27 rotates a Sprocket Wheel 28, on the shaft of which is a Worm 29 engaging a $\frac{1}{2}$ " Pinion on the Rod 26. A $\frac{3}{4}$ " Sprocket Wheel 30, also secured to the Rod 26, engages a further length of Sprocket Chain 25, one end of which is secured to the framework of the trolley, and the other carries the hooks supporting the load.

This Hoist is used to handle the material to be cut in the Meccano Stone-Sawing Machine (Model No. 6.42) and may be employed in all similar models.

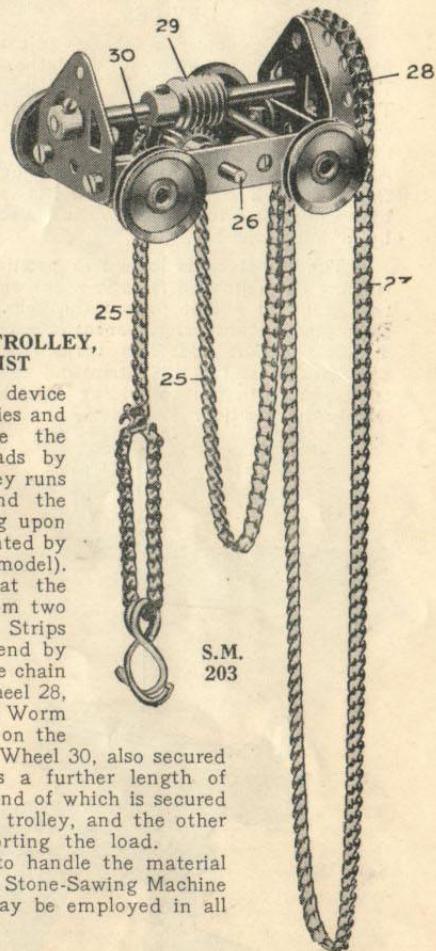

S.M. 203

Section X. Overhead Trolleys & Trucks for Gantries, etc.—(continued)

S.M. 204—OVERHEAD TRAVELLER FOR GANTRY

The axles 1 of the travelling wheels are journaled through the ends of four $2\frac{1}{2}$ " Strips 2 placed together and spaced by Washers in a central position in the trolley 4. Two pairs of 2" Strips 3 are bolted to the Strips 2 and are connected at their lower ends by Curved Strips 6. $\frac{1}{2}$ " loose Pulleys 12 on short Rods 7 form guides for the hoisting cord 9, which passes round a 1" Pulley 13 in the pulley block 8. The latter is constructed from two Triangular Plates spaced apart by Collars 10 and secured by $\frac{3}{4}$ " Bolts 11. The Hook 14 is suspended from a 1" Axle Rod 15.

The trolley is caused to travel along the rails by means of the cord 5, both ends of which are secured to the framework 4 (see S.M. 215).

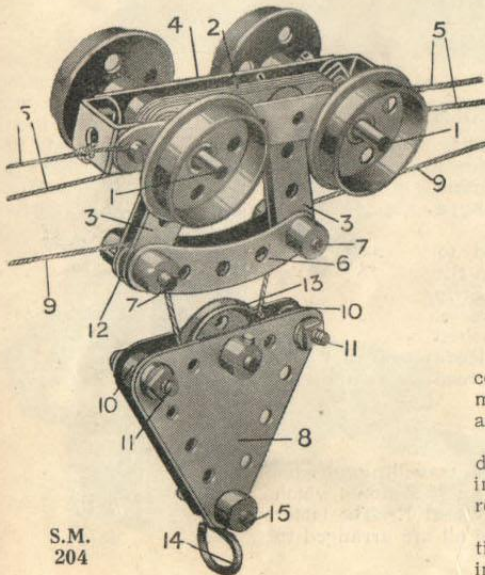

S.M.
204

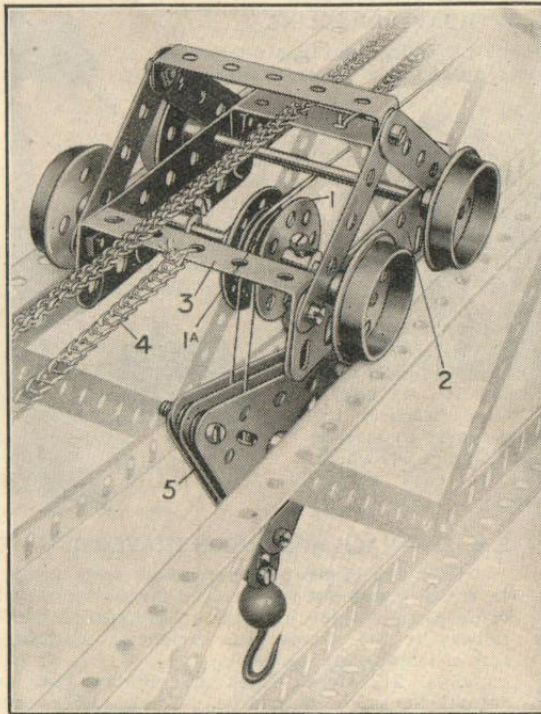

S.M. 205—OVERHEAD TRAVELLER FOR GANTRY, AND TWO-SHEAVED DEEP GROOVED PULLEY

The wheel-base 2 is constructed from two $3\frac{1}{2}$ " Flat Girders connected by $2\frac{1}{2}$ " \times 1" Double Angle Strips 3. The traversing movement is imparted by means of a Sprocket Chain 4, the ends of which are connected to the Bent Strips 3 (see S.M. 215).

A feature of this trolley is the two-sheaved pulley 1 with specially deep grooves. This is built up in a similar manner to that described in S.M. 39, but in this case the 1" loose Pulleys 1A should be free to rotate at different speeds between the Bush Wheels.

The pulley block 5 is similar to that described in S.M. 32 (Section III), except that in this case there are only two movable sheaves instead of three.

S.M. 206—OVERHEAD TRAVELLER FOR GANTRY

The trolley in this illustration is constructed from two $3\frac{1}{2}$ " Strips 1 connected by $1\frac{1}{2}$ " \times $\frac{1}{2}$ " Double Angle Strips 2. The axles 3 and 3A of the running wheels carry two $2\frac{1}{2}$ " Strips 9 held between Collars and set-screws 10. The hoisting cord 6 is led over a $\frac{1}{2}$ " loose Pulley 5, situated between the $2\frac{1}{2}$ " Strips 9 on the axle 3A, and passes round a second $\frac{1}{2}$ " Pulley carried on the shank of the bolt 11 in the pulley block 7; from thence it passes over a further $\frac{1}{2}$ " Pulley 5A on the axle 3.

The traversing movement of the trolley is obtained from the cord 8, the ends of which are shown connected to the cross Strips 2.

The pulley block 7 is built up from two Flat Trunnions bolted together, Washers being placed between the Trunnions on the shanks of the bolts 12.

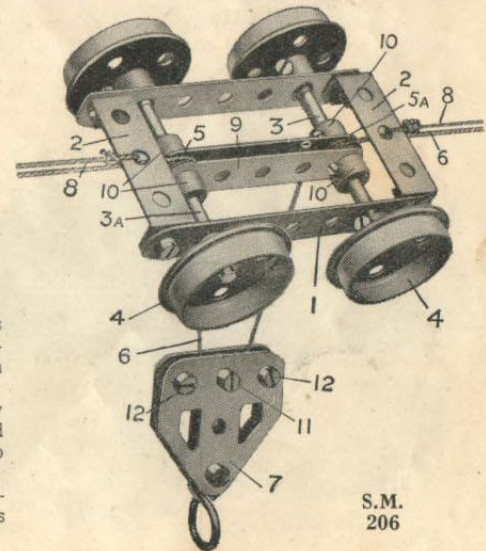

S.M.
206

Section XI. TRAVERSING MECHANISM

S.M. 211—TRAVERSING MECHANISM OF HEAVY DRAGLINE

S.M. 211 is an underneath view of the base of a heavy Dragline, and illustrates a type of traversing mechanism in which the driving power is coupled to sixteen travelling wheels running on a quadruple track.

The drive is led by way of a vertical shaft and Bevel Gears 6 and 7 on to the transverse $1\frac{1}{2}$ " Rod 5, and two $\frac{1}{2}$ " Pinions 4 on either end of this Rod 5 actuate further $\frac{1}{2}$ " Pinions 3, each of which is mounted separately on a short Rod. Four $\frac{3}{4}$ " Sprocket Wheels 2 secured to the shafts of the Pinions 3 are each connected by Sprocket Chain 1 to 1" Sprocket Wheels mounted on short Rods 8 journalled in the centre of the bogies 9. The eight wheel axles are all rotated in the same direction by means of $\frac{3}{4}$ " Pinions 10 gearing with 50-teeth Gear Wheels 11.

One of the four-wheeled bogies is shown in detail in S.M. 211A; the Crank 12, seen in this illustration, is bolted to two Double Brackets 13, and forms a socket to receive the upright columns 14, which are bolted to each corner of the base.

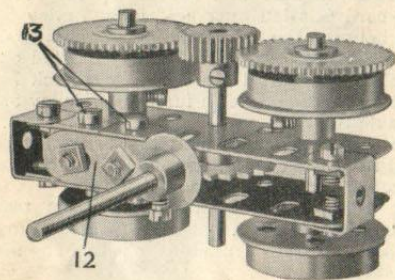

S.M. 211a

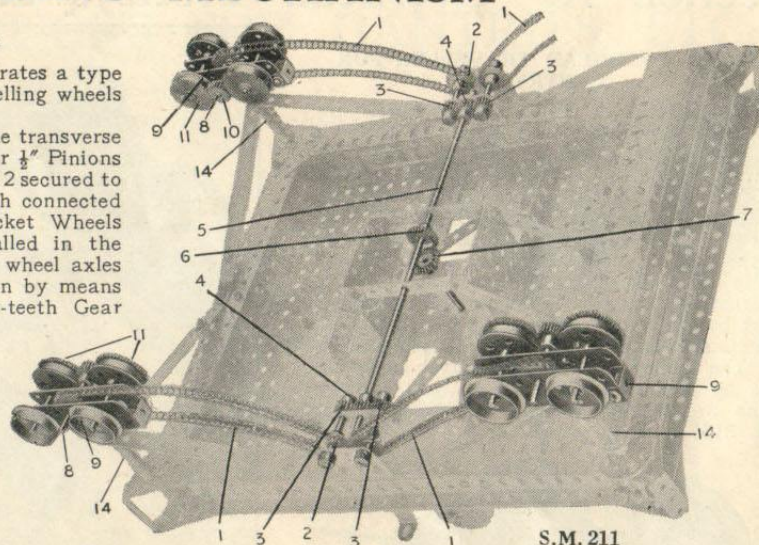

S.M. 211

S.M. 212—RACK AND PINION TRAVERSING MECHANISM

Rack and Pinion gear possesses a wide range of utility. In actual practice it is employed for an innumerable variety of purposes, ranging from the operation of a steep mountain railway to the simple gear sometimes used in opening a row of factory windows.

S.M. 212 shows Rack and Pinion gear adapted to actuate the saddle of a lathe. The saddle 1 rests upon the Girders 2, and is bolted to a $2\frac{1}{2}$ " x $\frac{1}{2}$ " Double Angle Strip sliding upon a Rod set longitudinally between the Girders. The shaft 3 of the hand-wheel 4, journalled in strips 5 bolted to the saddle, carries a $\frac{1}{2}$ " Pinion which engages the Rack Strips 6. As the hand-wheel rotates, the Pinion is forced along the Rack, carrying the saddle with it.

S.M. 213—TRAVERSING MECHANISM

This illustrates the foot of a crane or similar model, in which the travelling wheel 1 is operated from a hand-wheel 2. The shaft 3 of the hand-wheel carries a $\frac{3}{4}$ " Pinion 4 which engages a 50-teeth Gear Wheel 5 secured to the axle of the Flange Wheel 1. The latter is one of four wheels similarly situated in the base of the model, and all are arranged to traverse a suitable stretch of track.

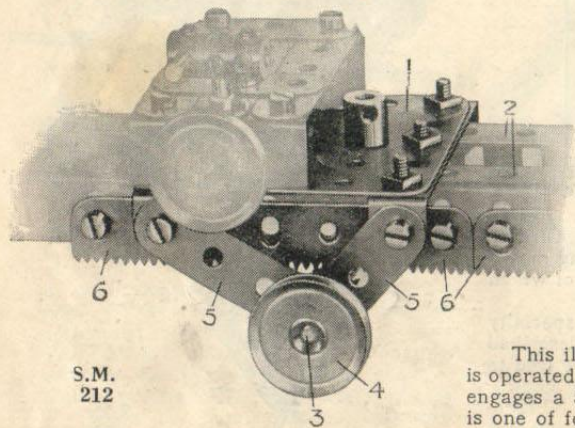

S.M. 212

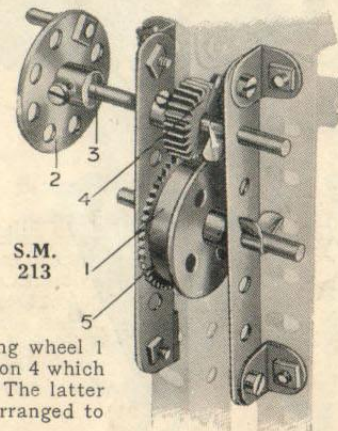

S.M. 213

Section XI. Traversing Mechanism—(continued)

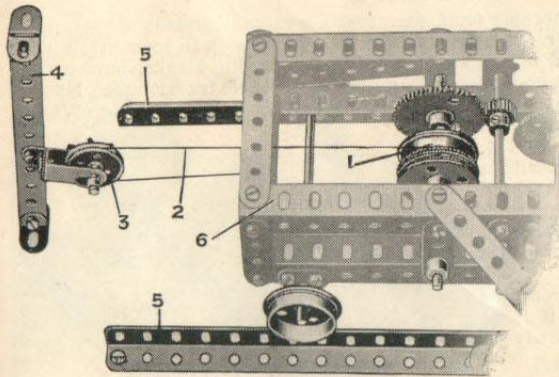

S.M. 214

S.M. 215—ENDLESS ROPE TRAVERSING GEAR

This movement may be employed in overhead cranes, gantries, endless-rope railways, transporters, conveyors, etc., and numerous other models where it is required to move a trolley or truck to and fro along a stretch of track. Its construction consists of an endless cord secured to the trolley and passing round a pulley at either end of the runway. One of the pulleys imparts the motive power, and the cord should be given an additional turn round this pulley to obtain sufficient "grip." Sprocket Chain may be used in place of the cord, when a more powerful and reliable drive will be obtained.

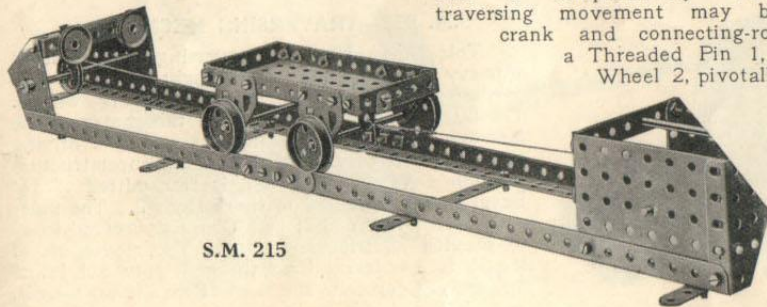

S.M. 215

S.M. 214—SELF-HAULED TRAVELLING CARRIAGE

In this interesting apparatus the moving machine pulls itself along, by means of a revolving drum 1 which slowly winds up a cord 2. The latter passes round a 1" Pulley 3, carried from the post 4 secured in position at the head of the track 5, and its end is attached to the framework of the carriage 6. S.M. 214 illustrates a section of the Coal-Cutting Machine (Model No. 7.2) in which this type of traversing mechanism is employed in moving the cutting tools slowly along the coal face as the coal is cut away.

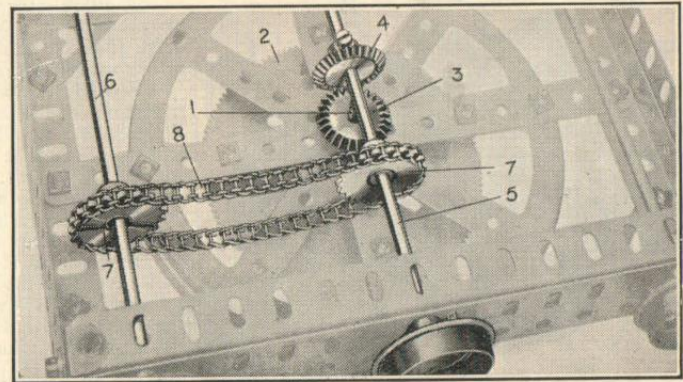

S.M. 216

S.M. 216—TRANSMISSION OF MOTIVE POWER TO ROAD WHEELS

S.M. 216 is an underneath view of the wheel-base of the Steam Shovel (Model No. 7.8). In this model the Motor is carried in the swivelling superstructure and the drive is led down to the road wheels by way of the vertical shaft 1. This shaft is journaled through the boss of the 3½" Gear Wheel 2, about which the superstructure pivots, and carries a Bevel Wheel 3 gearing with a similar wheel 4 on the transverse Rod 5. The latter forms an axle for the centre pair of the six road wheels. Motion is also imparted to a second pair of wheels on the axle 6 by means of 1" Sprocket Wheels 7 and Sprocket Chain 8.

S.M. 217—RECIPROCATING MOTION

Where a part of a machine is required to reciprocate over a comparatively short distance, the necessary traversing movement may be imparted by ordinary crank and connecting-rod gear. In S.M. 217

a Threaded Pin 1, secured to the Bush Wheel 2, pivotally carries a connecting Strip 3, which imparts to and fro movement to a carriage sliding on guide Rods 4.

Further examples of Reciprocating Drive mechanisms are given in S.M. Nos. 252 and 264 (Section XIII).

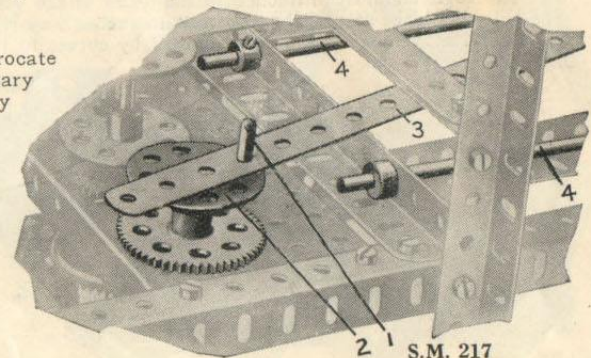

S.M. 217

Section XI. Traversing Mechanism—(continued)

S.M. 218—QUICK-RETURN MOTION

A quick-return gear adapted in actual practice to machine tools, etc., forms a valuable means of speeding-up production. When fitted to a planing-machine, for example, as in S.M. 218, this gear so controls the drive that the table carrying the material to be shaped moves slowly during the cutting stroke, but on the return movement, during which the cutting tool performs no work on the material, the table travels much faster.

A vertical driven shaft 5 carries a Bush Wheel 6, and a $\frac{3}{8}$ " Bolt passed through one of the holes in the Bush Wheel is secured in the boss of an Eye Piece 7. A $3\frac{1}{2}$ " Strip 3 passed through the Eye Piece pivots about an upright fixed Rod 4, and is attached at its outer end 2 by pivot bolt and nuts to a connecting lever 1. The latter, in turn, is pivotally connected to the underside of the table, which slides on the Girders 8.

The Bush Wheel 6 rotates in an anti-clockwise direction, rocking the lever 3 to and fro, and the swivel-guide 7 slides on the lever as it follows the movement of the Bush Wheel. Consequently, the guide 7 is at a greater distance from the fulcrum of the lever during the forward stroke than it is on the return, with the result that the point 2 moves slowly on the forward stroke and more rapidly on the return.

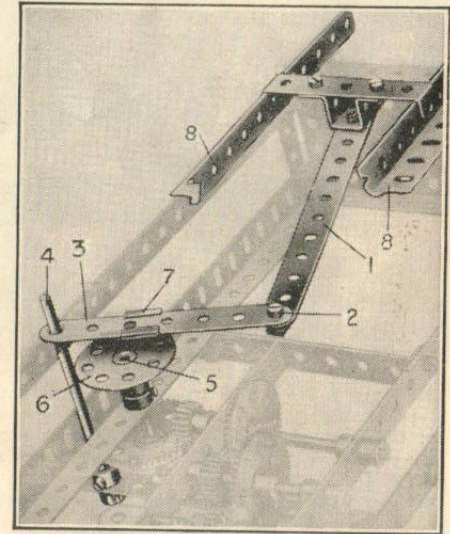

S.M. 218

S.M. 220—TRAVERSING MECHANISM

This shows how the traversing movement of a heavy structure may be brought about by imparting motion to numerous travelling wheels. The illustration is of one side of the gantry of the Meccano Giant Block-Setting Crane. The driving power is led down from the swivelling superstructure through a vertical rod, and is transmitted to $1\frac{1}{2}$ " Bevel Gears 1 secured to short Rods 2. The inner ends of the latter abut in a Coupling secured so as to provide additional support. The movement of the Rods 2 is transmitted through Universal Joints and Bevel Gearing to the axles of the driving wheels.

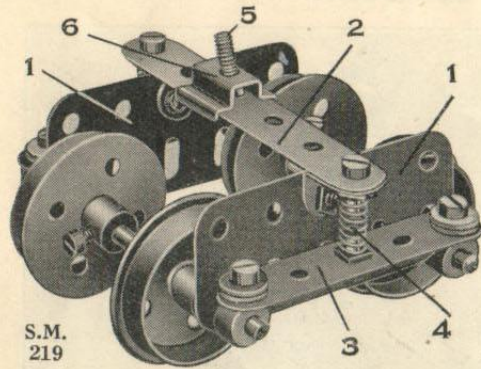

S.M. 219

S.M. 219—BOGIE WITH EQUALISING BEAMS

A simple but efficient four-wheel bogie of the type shown in S.M. 219 often is required when constructing Meccano locomotives, trams, and other vehicles that are designed to run on rails.

The bogie frame is built up from two $2\frac{1}{2}$ " Flat Girders 1 connected together by a 3" Strip 2. The axle boxes are represented by Collars, and each pair of Collars is connected by an equalising beam consisting of a $2\frac{1}{2}$ " Strip 3. A $\frac{3}{8}$ " Bolt secured in the centre hole of the latter enters the coil of a Compression Spring 4, which is retained in place by the shank of another $\frac{3}{8}$ " Bolt that serves to secure the Strip 2 to the Angle Bracket.

The equalising beam 3 is secured to the Collars by set-screws, and two Washers are placed under the head of each screw to prevent its shank touching the axle, which must be quite free to turn in the Collars. The axles are journaled in the elongated holes of the Flat Girders and since the weight of the vehicle is taken by the Spring 4, attached to the centre of the equalising beam, each axle is able to move in a vertical direction simultaneously with, or independently of, the other axle.

The bogie should be attached to the frame of the vehicle by means of the bolt 5 inserted in the Eye Piece 6. The bolt should be secured by two nuts in such a way that the bogie is quite free to pivot about it (see No. 262). The lateral movement of the bogie caused by curves in the track is allowed for by the Eye Piece 6 sliding on the Strip 2.

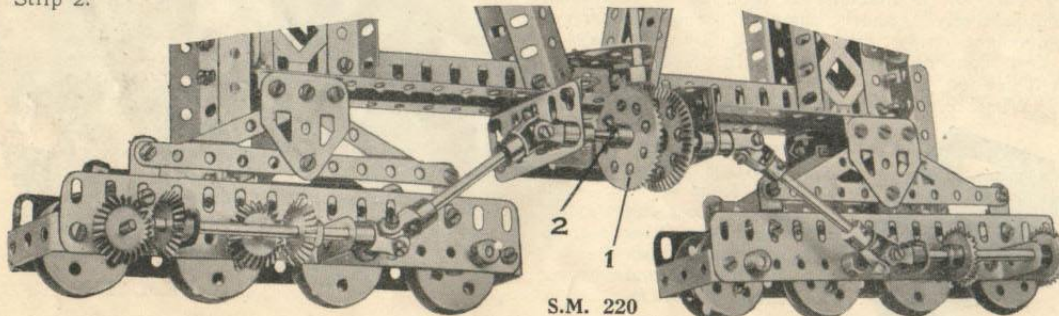

S.M. 220

Section XII. GRABS, BUCKETS and DREDGING APPARATUS

S.M. 231—SHOVEL FOR GIANT EXCAVATOR

This bucket is designed for use in Steam Shovels or other excavating machines. It is bolted to the arm 1, which pivots from a point in the jib of the excavator. The bottom Plate 2 of the bucket is hinged to the Rod 3, and is closed or opened as desired by means of a sliding Rod 4, operated by a cord 5. Thus, during the cutting stroke, the Plate 2 is held in a closed position by the end of the Rod 4 engaging a Flat Bracket 6. When the loaded bucket is moved over to the point where the material is to be dumped, its contents are released by pulling the cord 5. The bucket is raised or lowered by a cord 7 engaging a Pulley 8 pivotally carried on a Rod 9. The radius of the cut is regulated by altering the length of the arm 1, which is controlled by rack and pinion mechanism in the jib.

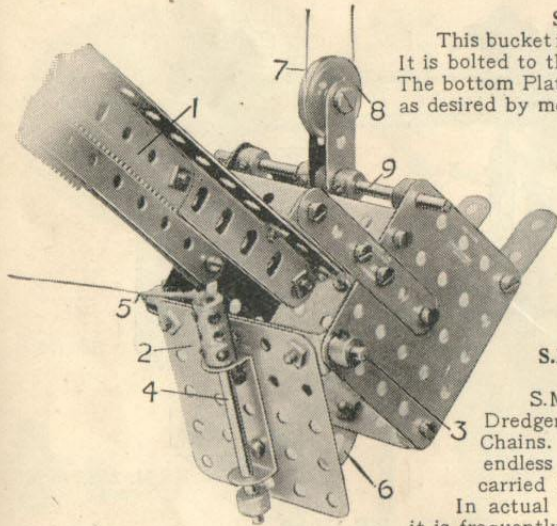

S.M. 231

S.M. 232—BUCKET DREDGING APPARATUS, or BUCKET CONVEYOR

S.M. 232 clearly shows the method by which Meccano Dredger Buckets (Part No. 131) may be secured to Sprocket Chains. Any number of buckets 1 may be connected to the endless chain 2, which passes round a Sprocket Wheel 3 carried in the end of the dredger arm.

In actual practice this mechanism is used for other work in addition to dredging; it is frequently employed, for example, in elevators and conveyors for coal slack, gravel, cement, and for loading similar materials in wagons, etc.

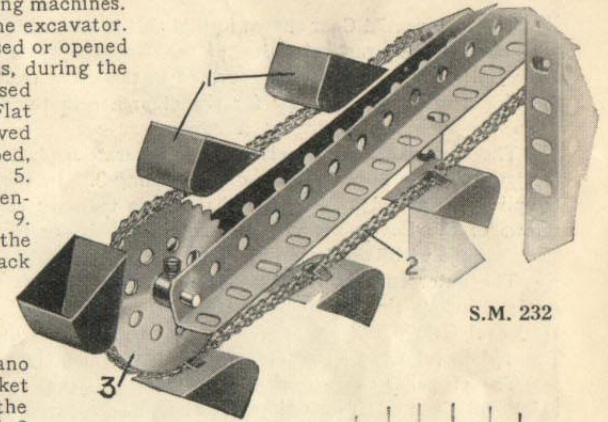

S.M. 232

S.M. 233—BUCKET FOR DRAGLINE EXCAVATOR

The construction of the bucket will be followed from the illustration. On the cutting stroke, the teeth 1 are drawn into the earth by means of the Chain 2, while a cord 3 sustains the bucket at the requisite angle. The apparatus is raised or lowered by means of the pulley block 4.

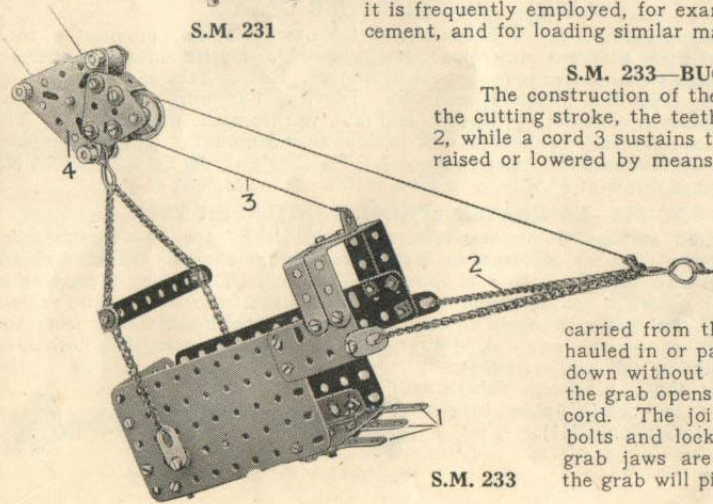

S.M. 233

S.M. 234—GRAB

The grab jaws are constructed from $2\frac{1}{2}$ " Triangular Plates 1 extended at their bases by $2\frac{1}{2}$ " Curved Strips 2. The grab is raised or lowered by means of four lengths of cord 3, while another cord 4 passes round a 1" Pulley carried from the cross-piece 5. If both the cords 3 and 4 are hauled in or paid out at the same speed, the grab travels up or down without the jaws moving, but if one cord ceases to move, the grab opens or closes according to the movement of the other cord. The joints marked "A" are all pivoted by means of bolts and lock-nuts (see S.M. 263). If the outer sides of the grab jaws are filled in with cardboard, or additional parts, the grab will pick up small loads of sand, marbles, etc.

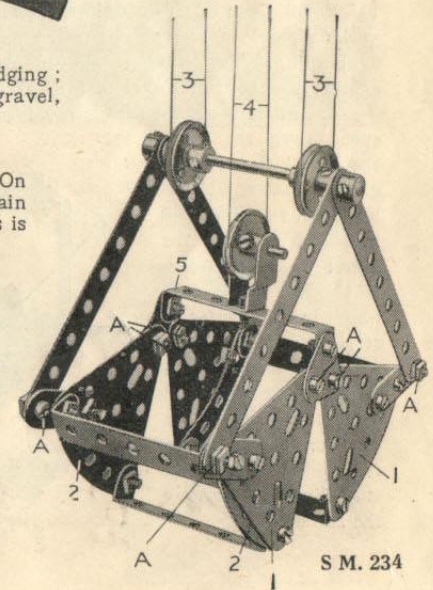

S.M. 234

Section XIII. MISCELLANEOUS APPLIANCES

S.M. 251—DIFFERENTIAL GEAR

The Differential Gear shown in S.M. 251 is undoubtedly one of the most interesting examples of the practical value of the Meccano system. As all Meccano boys are aware, differential gear is incorporated in the drive transmission on every motor-car; the object of this is to allow for the difference in the speed of the outer road wheel when the vehicle is turning a corner.

The back axle shaft consists of two separate Rods 1 and 2, the inner ends of which are journaled in opposite ends of a Coupling 3. In the centre transverse hole of this Coupling is secured a 2" Rod 4 that serves to carry the $\frac{7}{8}$ " Bevel Gears 5. The set-screws of the Bevels are removed so that they are free to turn about the 2" Rod. They engage with two similar Bevels 6 and 7 secured to the shafts 1 and 2 respectively.

The outer ends of the Rod 4 are passed through the elongated holes of 1" x $\frac{1}{2}$ " Angle Brackets that are secured rigidly by means of $\frac{1}{8}$ " Bolts to opposite holes in the $1\frac{1}{2}$ " Bevel Gear 8 and are spaced therefrom by means of Collars placed upon the bolts. The $1\frac{1}{2}$ " Bevel Gear is free to revolve independently about the axle shaft 2.

The propeller shaft 9 is secured in the $\frac{1}{2}$ " Bevel Gear 10 which engages with the $1\frac{1}{2}$ " Bevel Gear 8. Two Collars 11 should be secured to the shaft 2 to maintain the various gears in correct alignment and to prevent the gears 8 and 10 from slipping or binding. Two washers should also be placed against the boss of Bevel 6, for spacing purposes.

If one of the road wheels revolves at a greater speed than the other the Bevel Gears 5 begin to rotate and thereby adjust the difference in speed between the Bevel Gears 6 and 7. If the vehicle is running in a perfectly straight course the axles 1 and 2 and Bevel Gears 5, 6 and 7 must all rotate as one unit, since the road wheels are travelling at exactly the same speed.

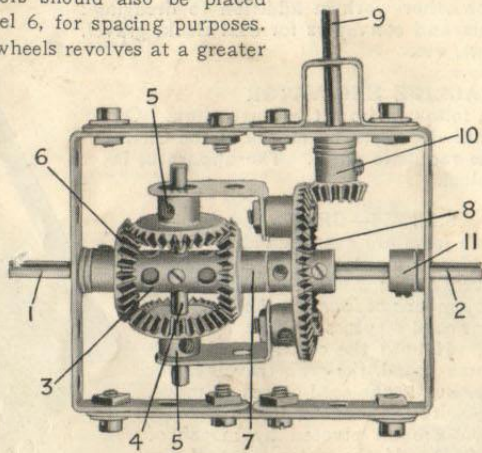

S.M. 251

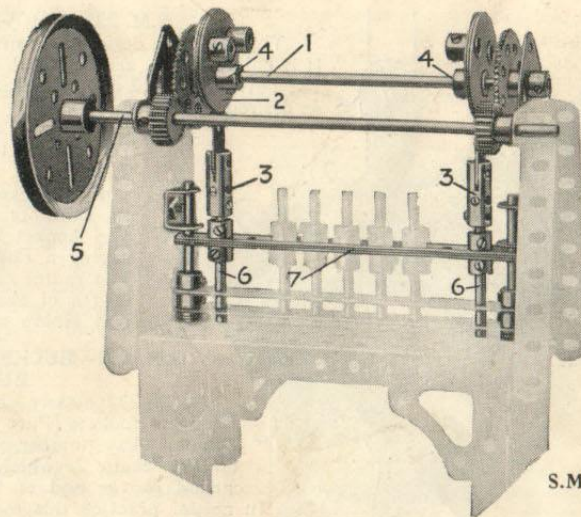

S.M. 252

S.M. 252—RECIPROCATING GEAR

The Meccano Triple-throw Eccentric, as the name implies, provides a total "travel," of three different dimensions, $\frac{1}{2}$ ", $\frac{3}{4}$ ", and 1". By its aid any continuous movement may be converted to reciprocating motion. S.M. 252 shows two Eccentrics operating the tools of a punching machine. The Rod 1 is journaled through the Eccentric bosses 4, providing $\frac{1}{2}$ " throws, and is driven from the main shaft 5. The Eccentrics 2 are pivotally connected to Strip Couplings 3 mounted on guide Rods 6, which carry the punches from a cross piece 7. The Single-throw Eccentric (part No. 170) provides a throw of $\frac{1}{4}$ " only, or a total rectilinear movement of $\frac{1}{2}$ ".

S.M. 253—LAMINATED SPRING, CANTILEVER TYPE

Laminated springs—sometimes referred to as "leaf" springs—may be constructed from a number of Meccano Strips of varying lengths. The Strips are slightly bent and bolted together as shown in S.M. 253. The spring illustrated is designed for use in a motor chassis; it is bolted to the framework of the vehicle by means of the Angle Brackets shown, and supports the road wheels from the Double Bracket at the end. A similar spring frequently in use has both ends attached to the vehicle, whilst its centre is secured to the road axle. This is known as the semi-elliptic type. (See S.M. 161, Section VIII).



S.M. 253

Section XIII. Miscellaneous Appliances—(continued)

S.M. 261—OVERHEAD GEAR FOR ELECTRIC LOCO

S.M. 261 illustrates a current collector, or pantograph, of the type used on electric locomotives employing the overhead wire system. Four 2" Threaded Rods 1 rigidly connected to the 2" Rods 2 and 2a by Collars 3 carry further Collars 3 in which the 2" Rods 4 must be free to turn. The Threaded Rods 5 enter four further Collars on the Rods 4 and grip the latter rigidly, and their other ends enter four more Collars mounted on a 2" Threaded Rod 6. The latter turns freely in all four Collars, and carries at either end a Threaded Boss 7. A piece of stout copper wire 8 is secured in these Bosses by grub screws 9.

The pantograph is prevented from sagging to one side by Sprocket Chains 10 and 11, which permit a vertically-folding or extending movement only. The chains are arranged oppositely—that is, while chain 10 passes under its respective Collar on Rod 2a and over the Collar on Rod 2, chain 11 passes over the Collar on Rod 2a and under that on Rod 2. A Spring Connecting the Rods 2 and 2a tends to raise the Rods 1, thus extending the pantograph, with the result that the copper wire 8 presses against the overhead wire. The pantograph is insulated from the loco roof by 6 B.A. Bolts and Insulating Bushes and Washers. The current is led to the Motor via the framework of the pantograph and the insulated wire 12.

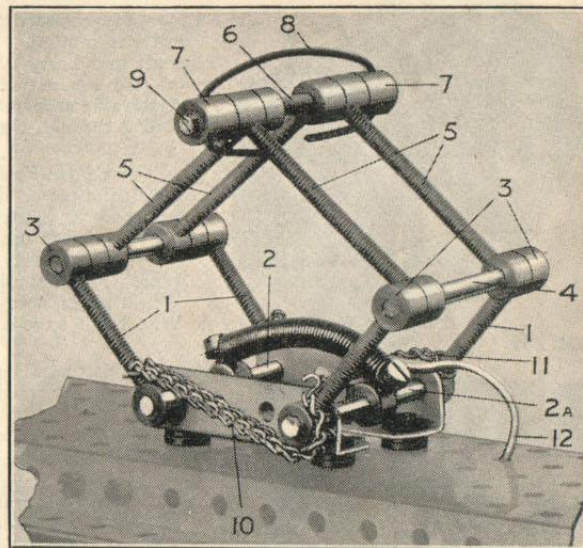

S.M. 261

S.M. 262—PIVOT, FORMED FROM BOLT AND NUTS

A simple type of pivot, or swivel-bearing, which proves extremely useful in Meccano models, is shown in S.M. 262. The bolt 1 passes through the Strip 2 and is securely held to Strip 3 by means of two nuts 4 and 5, which are screwed tight against opposite sides of the Strip. Sufficient space is left between the nut 5 and the bolt head to allow free movement of the Strip 2.

S.M. 263—BOLT AND LOCK-NUTS

Another form of pivot, or swivel-joint, may be constructed by first placing the Strips 2 and 3 (see illustration S.M. 262) on the bolt 1 and locking the nuts 4 and 5 on its shank. The nuts are turned in opposite directions until they securely grip each other in position on the bolt. This arrangement allows for free movement of both Strips, independently of the bolt.

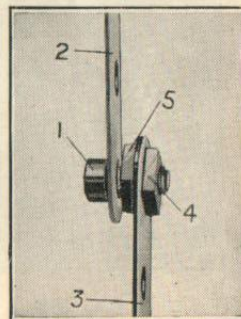

S.M. 262

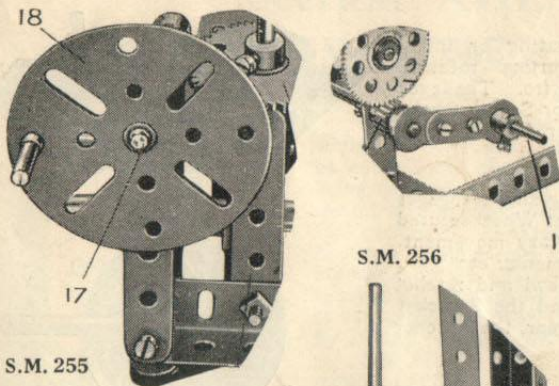

S.M. 255

S.M. 256

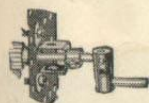

S.M. 257



S.M. 258

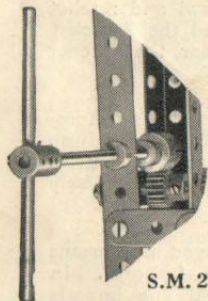

S.M. 259

EXAMPLES OF MECCANO HANDLES, etc.

S.M. 255—Hand-wheel, constructed from a Face Plate 18, rotating about the shaft 17, and carrying a Threaded Pin.

S.M. 256—Crank handle, composed of two Cranks bolted together, and short Rod 1.

S.M. 257—Crank handle, formed from a Coupling and short Rod.

S.M. 258—Hand lever. The Threaded Pin engages one of the screwed borings in the end of the Coupling.

S.M. 259—Double hand lever, consisting of a transverse Rod mounted in a Coupling.

Further examples are also shown in S.M. Nos. 5, 61, 63, 67, 72, 86, 137, etc.

S.M. 260—PEDESTAL

This detail illustrates an interesting adaptation of Meccano Couplings and Rods to form a firm base, or pedestal, for a vertical column, etc.

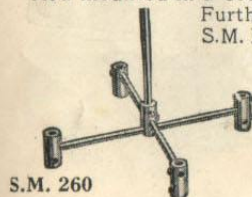

S.M. 260

Section XIII. Miscellaneous Appliances—(continued)

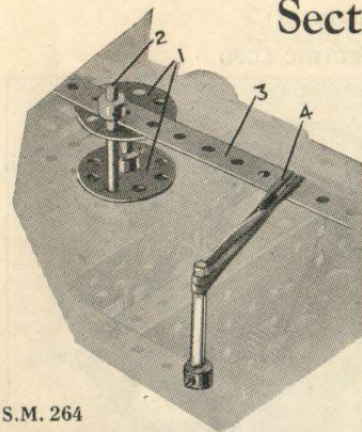

S.M. 264

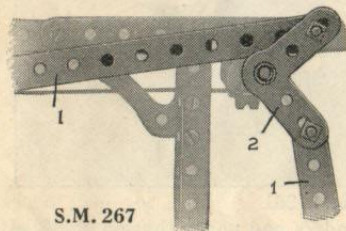

S.M. 267

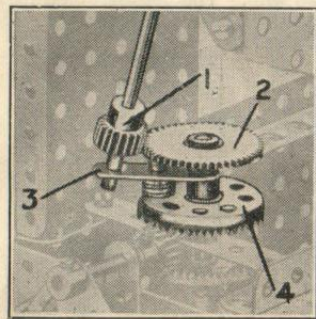

S.M. 268

S.M. 264—CAM, OR TAPPET

For converting a regular rotary motion into a reciprocating or intermittent motion. Two Bush Wheels 1 are mounted on a vertical rotating shaft and carry a short Rod 2 which pushes a lever 3 to and fro. The lever is held against the Rod 2 by means of a piece of elastic 4 (or Spring Cord). A suitable stop may be placed in position to prevent the lever following the Rod 2 through the full distance as the latter retreats.

S.M. 265—INTERMITTENT ROTARY MOTION

A Centre Fork, carried in a Coupling secured to a revolving shaft, engages for a brief period in each revolution with the teeth of a 2" Sprocket Wheel secured to a second shaft, so imparting to the latter an intermittent rotary movement. This device is useful in revolution indicators, measuring instruments, etc.

Intermittent rotary motion may also be obtained by pawl and ratchet gear. For example, if one of the Pawls in S.M. 99 is removed and the Sprocket Wheel given a to-and-fro motion by crank and connecting-rod gear, the Ratchet Wheel will have a motion similar to that in S.M. 265.

S.M. 266—CAM, OR TAPPET

This resembles S.M. 264 and converts a regular rotary motion into a reciprocating or intermittent motion. It consists of two 1½" Pulley Wheels 1, or Bush Wheels, carrying three Double Brackets 2 and secured to a revolving shaft 3. As the cam rotates, the Brackets 2 raise or lower a lever resting transversely upon the Rod 3.

The ECCENTRIC is a form of cam (see S.M. 252).

S.M. 267—BELL CRANK

The bell crank is a lever of the first order, and is employed as a means of increasing or decreasing movement or changing the direction of a force. In S.M. 267, the levers 1 are set at right-angles to each other, and one imparts motion to the other through the Bell Crank 2 (Part No. 128), to which the levers are pivotally connected by bolts and nuts (see S.M. 262).

S.M. 268—EPICYCLOIDAL GEAR

In epicycloidal gear one toothed wheel is caused to rotate about the circumference of another. The Pinion 1 in this detail engages with the Gear Wheel 2, and is carried on a shaft journaled in a 1½" Strip 3 bolted to a Contrate Wheel 4, which rotates freely upon the vertical Rod. The latter may be secured in position, so preventing the Gear Wheel 2 from turning, or it may be rotated at a different speed—or in an opposite direction—to the Contrate Wheel 4. The number of revolutions described by the Pinion 1 always exceeds that of the Contrate 4, but the speed ratio varies according to the sizes of the Pinion and Gear Wheel 2, and to the movement (if any) of the latter.

S.M. 269—MEASUREMENT OF ANGLES

The Meccano Protractor (Part No. 135) consists of a sheet of superfine Esparto board on which are printed graduated circular and semi-circular scales. These may be cut out and affixed to models in which it is desired to measure angles, degrees, etc. S.M. 269 shows the semi-circular scale 1 and the circular scale 2 attached to the sighting arm and fixed base respectively of a theodolite. Note the "plumb-line"—the Coupling 3 suspended by cord 4—by which the perpendicular is ascertained.

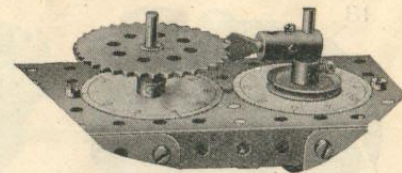

S.M. 265

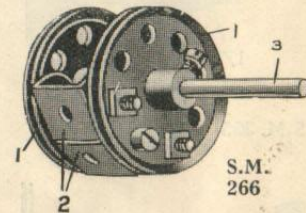

S.M.
266

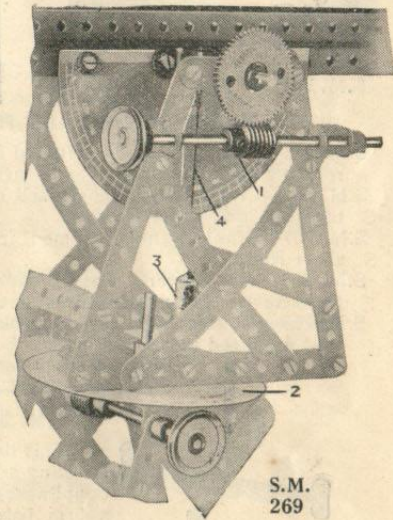

S.M.
269

Section XIII. Miscellaneous Appliances—(continued)

VARIABLE AND MULTIPLE DRIVING MECHANISM

S.M. 270—VARIABLE ROTARY DRIVE

S.M. 270 illustrates a method by which the length of a driven shaft may be varied while it is in motion. The detail shows the gear adapted to a drilling machine. It will be noticed that the vertical drill shaft is in two segments, the upper driven segment 10 being connected to the lower by means of a Bush Wheel 1 engaging two short Rods 2 mounted in another Bush Wheel 3, which is secured to the lower segment 4. The drilling tool carried on the latter is applied to the work on pressing a lever 5, and on release is returned to its former position by the Compression Spring 7 (Part No. 120B), which is mounted on the shaft 4 between a Collar 6 and the Double Angle Strip forming the bearing 8. The spring should be slightly stretched before being used in this apparatus. It will be noticed that the short Rods 2 adjust themselves to the movement of the drill by sliding in the holes of the Bush Wheel 1.

S.M. 270A is another view of the drill-adjusting device. The lever 1 is pivotally mounted at 3 by means of bolt and lock-nuts (S.M. 263) and engages with the Eye Piece 2. The latter is connected—also by bolt and lock-nuts—to a Double Bracket 9 (S.M. 270) mounted on the drill shaft 4. If a new type Eye Piece is used the Lever 5 must be spaced further away from the drill shaft.

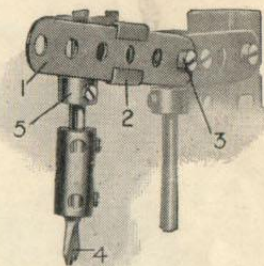

S.M. 270a

S.M. 271—MULTIPLE-DRIVE MECHANISM

This mechanism is frequently employed in multiple drilling machines and similar apparatus where a number of shafts are required to rotate at a uniform speed and in the same direction. A vertical Rod 5 carries a $1\frac{1}{2}$ " Contrate Wheel 7, which is driven by the $\frac{1}{2}$ " Pinion 8 secured to the belt pulley shaft. The Rod 5 is journalled through the bosses of two Face Plates 1 and 2, bolted to the upright column of the machine, and carries a 57-teeth Gear Wheel 4. The latter drives $\frac{1}{2}$ " Pinions 3 secured to the four counter-shafts 6, which carry the tools mounted in Couplings.

S.M. 272—UNIVERSAL JOINT

The Meccano Universal Coupling, or universal joint (part No. 140) is designed to connect two rotating shafts lying in different planes, or meeting at a varying angle. An example of the universal joint is found in all motor cars, where it forms a flexible connection between the propeller shaft and the main driving shaft from the engine, so allowing for such vertical movement of the back axle as may be set up by the roughness of the ground, etc., over which the car travels. S.M. 272 shows the Coupling attached to the gear box of the Meccano Motor Chassis. Another excellent illustration of the use of this part will be found in S.M. 220.

S.M. 273—SPEED INDICATOR

An efficient instrument for measuring the speed of any rotating shaft may be constructed on the "centrifugal governor" principle (see S.M. 107), by employing the movement of the weights to actuate a pointer moving over a graduated scale (see Model No. 4.35, Manual of Instructions).

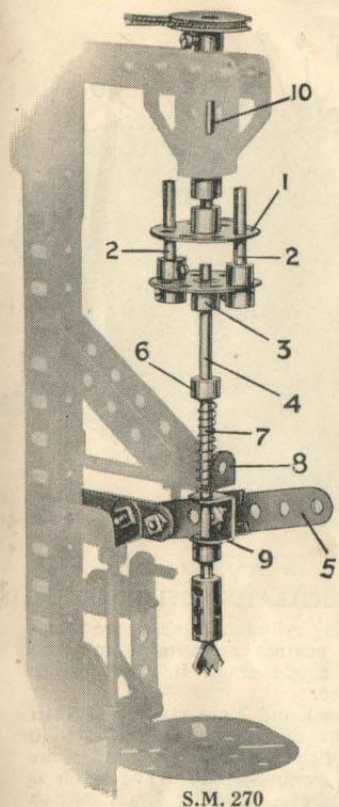

S.M. 270

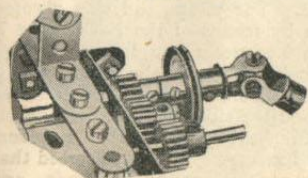

S.M. 272

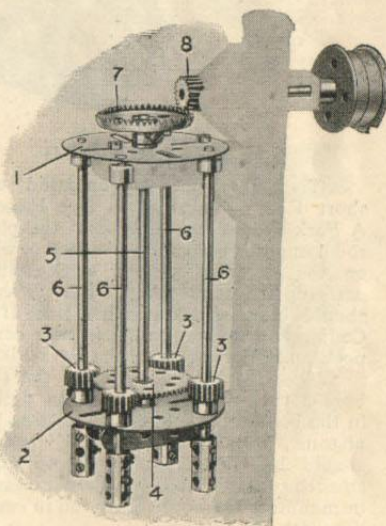

S.M. 271

Section XIII. Miscellaneous Appliances—(continued)

RECIPROCATING ENGINE MECHANISM

S.M. 274—BUILT-UP CRANKSHAFT

This is a typical Meccano crankshaft, complete with balanced cranks, eccentric, etc.

The end bearing for the crankshaft 1 is formed by a Trunnion 2. Collars 3 being secured to the shaft on either side of the bearing. The crank arms are built up from Cranks 5 and 5A bolted to opposite sides of a $2\frac{1}{2}$ " Triangular Plate 4, which forms a balance weight. The crank-pin 8 is secured in the bosses of the inner Cranks 5A, and carries the Coupling 9 secured to the connecting-rod 6. A Handrail Support 10 screws into the Coupling 9, but is spaced by Washers 11 in order that its bolt shall not grip the crank-pin. The Handrail Support is removed to admit oil through the Coupling to the crank-pin when lubricating the model.

The Eccentric 7 operates the valve mechanism, its arm being extended by a Strip 12, while the Sprocket Chain 13 rotates the engine governor (see S.M. 107).

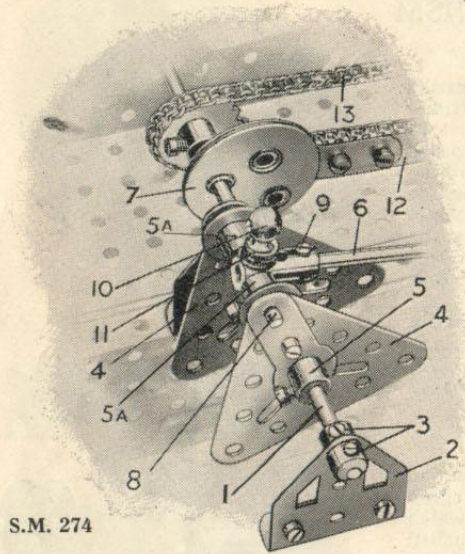

S.M. 274

S.M. 275—CROSSHEAD

The crosshead is composed of a short Rod 6 mounted in Eye Pieces 4. A Fork Piece 5 on the end of the piston rod 1 engages the transverse Rod 6, whilst on the latter is placed a Coupling 8 carrying the connecting-rod 2. Washers should be placed on either side of the Coupling 8 to retain it in the correct position in the centre of the Fork Piece.

The Eye Pieces 4 engage the slide-bars 3 ($3\frac{1}{2}$ " Strips) mounted in position in the base of the engine. The slide-bars, piston, and connecting-rod bearings should be oiled occasionally to ensure smooth running, and care should be taken in mounting the connecting-rod in correct line with the piston.

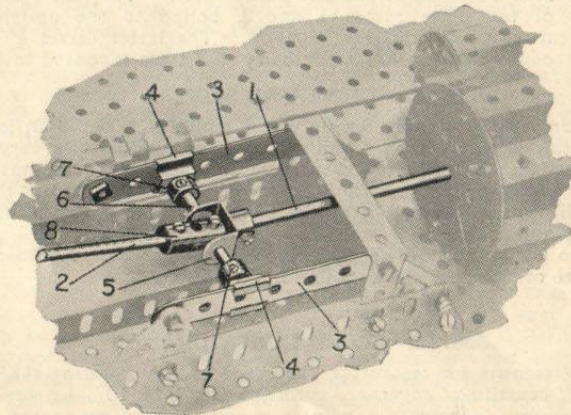

S.M. 275

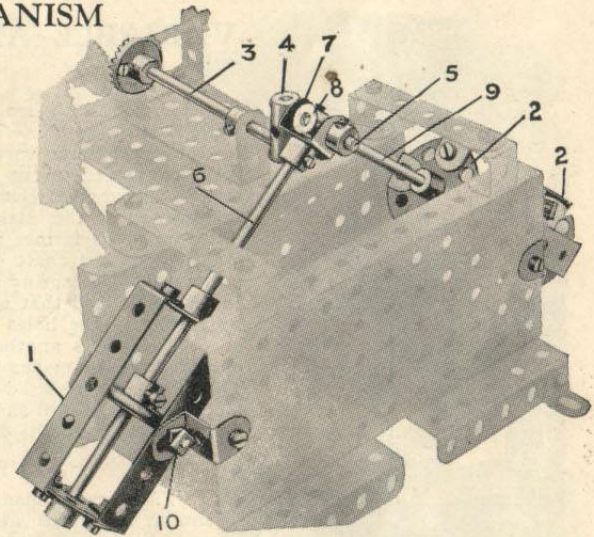

S.M. 276

S.M. 276—OSCILLATING CYLINDERS

Two oscillating cylinders, such as are found in small steam engines or pumps, may be connected to a single crank in the manner shown in S.M. 276.

The cylinders 1 and 2 are pivoted at their centres by means of bolts and lock-nuts 10 (see S.M. 263) and the piston rods 6 and 9 are journaled on the crank-pin 5. The latter is secured in the end of a Coupling 4 mounted on the crankshaft 3. The piston rod 6 is pivoted to the crank-pin by means of the Fork Piece 7, whilst the piston rod 9 carries a Coupling 8, through the transverse hole of which the crank-pin is journaled. Washers should be placed between the Coupling 8 and the sides of the Fork Pieces.

As the crankshaft rotates, the cylinders rock about their bearings. It will be noted that with this arrangement connecting-rods and crossheads are dispensed with.

Section XIII. Miscellaneous Appliances—(continued)

S.M. 277—WINDING GEAR FOR CRANES OR DERRICKS

The shaft of the winding handle 1, carrying a $\frac{1}{2}$ " Pinion 2, is engaged at one end by a $3\frac{1}{2}$ " Strip 4. The latter is bolted to the framework at 5 and is bent out a little to allow a Collar and Washer to be placed on the winding shaft between it and the frame of the gear-box. The Strip 4 thus serves as a spring which tends to retain the operating shaft in such a position that the Pinion 2 is out of engagement with the Gear Wheel 3 on the winding drum shaft. Consequently in order to rotate the drum the hand wheel 1 must be pressed inward while it is rotated; immediately it is released the Strip 4 returns it to its former position, throwing the Pinion 2 out of gear with the Gear Wheel 3.

On the other end of the drum 6 is mounted a Flanged Wheel 7 and Bush Wheel 8. These form a small drum about which the brake band 9 is wound. One end of the latter is tied to a Flat Bracket mounted on a Rod 10, whilst the other end is given a few turns round the Rod, and is secured to a bolt inserted in a Collar. On operation of a crank 11, the Rod 10 winds up the cord 9, so exerting a braking effect on the winding drum. A Ratchet Wheel 12 is secured to the shaft of the latter and is engaged by a Pawl 13. The necessary pressure is imparted to the Pawl by a piece of Spring Cord 14. The cord 15 secured to the Pawl is guided over a 1" loose Pulley 17, which revolves independently on the Rod 10 and is connected to a weighted lever 16. Normally the lever 16 rests against a stop 19; this allows the Pawl to engage the Ratchet Wheel 12. If the arm 16 is thrown over, however, its weight raises the Pawl clear of the teeth of the Ratchet and so leaves the winding drum free to revolve. This arrangement is useful when it is required to allow a load to run down by its own weight. A piece of cord 18 serves to anchor the weighted lever to the frame of the gear box.

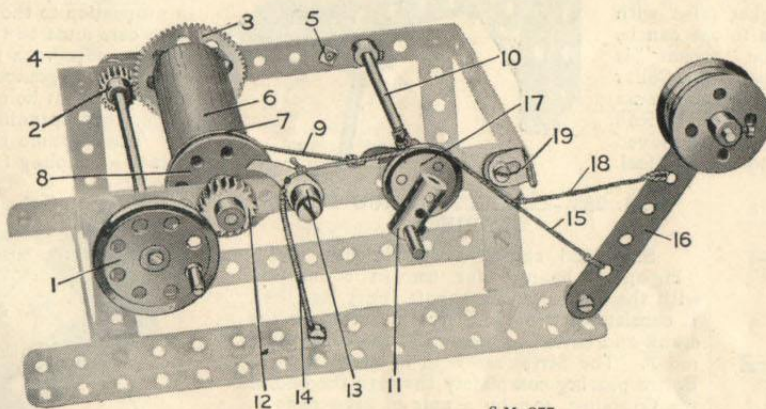

S.M. 277

S.M. 279—SUN AND PLANET MECHANISM

"Sun and planet" gear is used to convert the reciprocating motion of a piston into motion of rotation. The Strip 1 represents the connecting-rod, imparting reciprocating motion from the piston. This Strip is bolted to a 57-teeth Gear Wheel 2, which is free to move about a Pivot Bolt 3 secured to a 2" Strip 4. The Strip 1 should be spaced away from the Gear Wheel 2 by means of a Washer placed on each of the two bolts shown, in order that the Strip may clear the second Gear Wheel 5 when in motion, whilst another Washer should be placed on the Pivot Bolt 3 immediately behind the boss of the wheel 2. One end of the 2" Strip 4 is placed upon, and is free to revolve about, the driven shaft. (The Strip is spaced away from the Gear Wheel 5 by means of three Washers).

The Gear Wheel 2 does not revolve on its own centre but moves round the axis of the gear 5 with a slightly oscillating motion, and since the teeth of both wheels are in engagement, a rotary movement is imparted to the gear 5. The latter revolves twice on its axis to one circuit of gear 2, or two strokes of the piston.

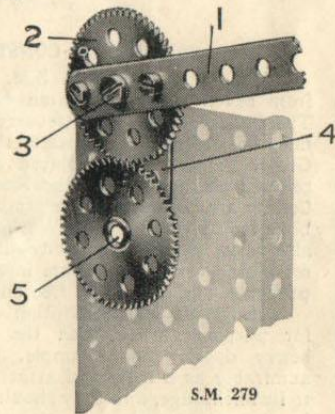

S.M. 279

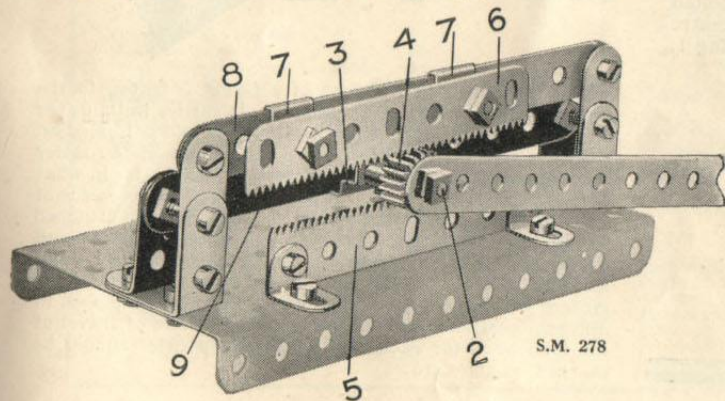

S.M. 278

S.M. 278—DEVICE TO INCREASE LENGTH OF A CRANK STROKE

S.M. 278 illustrates a form of rack and pinion mechanism with which the length of a crank or piston stroke may be doubled. The connecting- or piston-rod is placed on the end of a $\frac{1}{2}$ " Bolt 2, which passes through an Eye Piece 3 and carries on its shank a $\frac{1}{2}$ " Pinion 4. The latter rolls on a Rack Strip 5 secured by Angle Brackets to the base of the model. A second Rack Strip 6 bolted to two Eye Pieces 7 sliding on a $5\frac{1}{2}$ " Strip 8 also engages with the Pinion 4. At each stroke of the connecting-rod the Pinion 4 is caused to rotate, owing to its engagement with the Rack 5, and thereby thrusts the upper Rack Strip in the same direction as that in which the connecting-rod moves, but through a distance twice as great. Strip 8 is bolted at each end to $1\frac{1}{2}$ " Strips secured to the base by means of 1" Angle Brackets. A second guide Strip 9, secured at either end to a $1" \times \frac{1}{2}"$ Angle Bracket, supports the Eye Piece 3.

Section XIII. Miscellaneous Appliances—(continued)

S.M. 280—BALL-AND-SOCKET JOINT

As in actual engineering, a ball-and-socket joint—i.e., a joint that will enable a shaft to pivot freely in all directions—often is required in model building. Although it is not possible to actually reproduce a ball-and-socket joint with standard Meccano parts a close approximation to one can be obtained, as is shown in S.M. 280. In this the "socket" is represented by a Swivel Bearing 1 while the "ball" is a Collar 2 secured to the shaft 3. The Swivel Bearing is mounted on a short Rod which is free to turn in bearings 4. Hence the Rod 3, while rotating in the Collar of the Bearing 1, may be moved through any angle to the vertical.

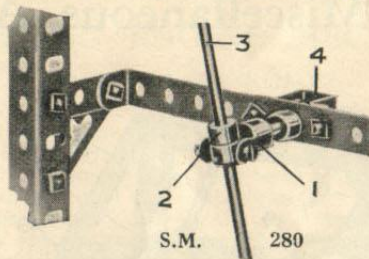

S.M. 280

S.M. 282—JIB RADIUS INDICATOR

The load capacity of a jib crane varies according to the particular angle of the jib, for the nearer the latter approaches the horizontal position the greater will be the strain upon it in proportion to the load. Therefore, when lifting a heavy load, care must be taken to see that the jib is at the proper angle to cope with that load. A radius indicator tells the operator at a glance the position of the jib, and the maximum load that he can handle safely without increasing its angle, thus speeding up luffing movements.

The Meccano radius indicator shown in S.M. 282 consists of a Coupling 1 that is free to turn about the $1\frac{1}{2}$ " Rod 2,

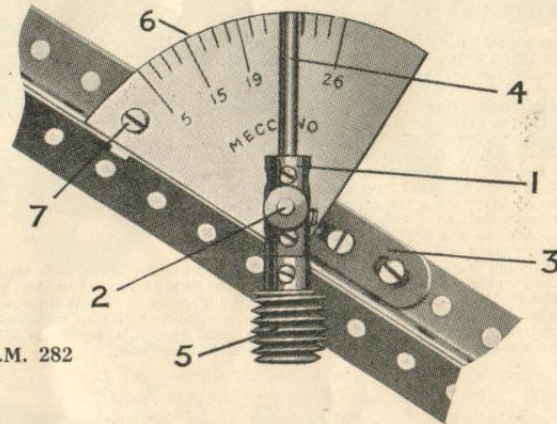

S.M. 282

S.M. 283—CONNECTING ROD END BEARING

S.M. 283 shows a simple but useful "big-end" bearing for use in connection with the Meccano Crankshaft (Part No. 134). It consists of two $1\frac{1}{2}$ " Strips mounted on the crank and bolted to the end of the connecting rod 2. The Strips are held in place by a $\frac{1}{2}$ " Bolt 3 passing completely through the end of the Coupling, and by a pair of set-screws 4, which serve also to grip the connecting rod in the Coupling. The position of the connecting rod in the centre of the crank is maintained by a Spring Clip 5 mounted between two Washers.

Alternatively two 1" Triangular Plates, used instead of the $1\frac{1}{2}$ " Strips, may be bolted to a second Coupling secured by its centre transverse hole at right-angles to Coupling 1.

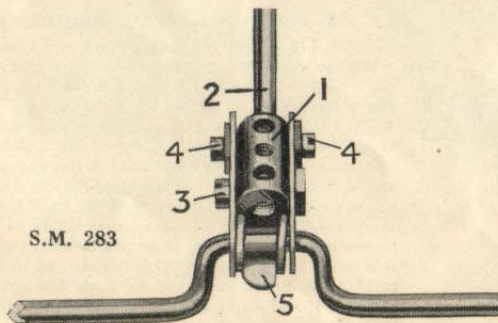

S.M. 283

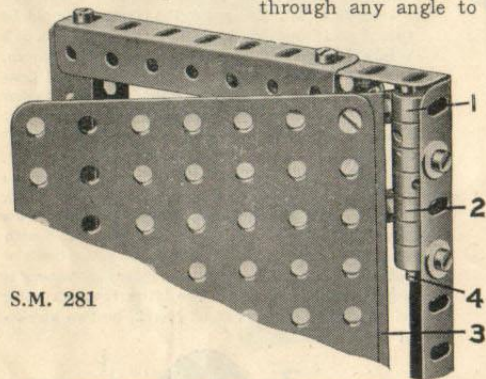

S.M. 281

S.M. 281—HINGE CONSTRUCTION

The hinge shown in S.M. 281 is built up from seven collars mounted on a $2\frac{1}{2}$ " Rod 4. The Collars 1 and 2 are secured to the door by means of ordinary bolts passed through the Angle Girder 3, nuts being placed on the bolts to prevent them touching the Rod 4. Two other Collars are secured to the jamb of the door by bolts suitably spaced by Washers. These bolts also serve to grip the Rod 4 in position. The remaining three Collars are inserted for spacing purposes, and should be free on the Rod.

Hinges of this description will prove useful for purposes other than the construction of heavy doors. For example, they will serve admirably as a means of attaching a lift-bridge to its anchorage, and they should be of assistance in the construction of tipping wagons with hinged sides, etc.

which is gripped in the boss of a Crank 3 bolted to the upturned flanges of the jib girders. It carries in its upper end a further $1\frac{1}{2}$ " Rod 4 and in its lower end a 1" Rod on which is secured the Worm 5. The weight of the latter serves to keep the Rod 4 always vertical, no matter in what position the jib is placed. A dial 6, shaped from a piece of stout cardboard, is bolted at 7 to an Angle Bracket attached to the jib. The Rod 2 passes through a hole in the dial and carries two or three Washers to space the Coupling 1 away from the card so that the Worm 4 will clear the edges of the girders forming the jib. The jib should now be placed in different positions and the radius of the circle of travel of the load hook for each position of the pointer should be marked on the card.

INDEX

Description.	Page.	S.M. No.
Ackermann Steering Gear ...	29	161
Adjusting Devices ...	33, 34	185, 186
Adjustment, Screw ...	34	188, 189
Aeroplane Control Gear ...	31	168
Ball and Socket Joint ...	47	280
Bearings, Ball, built-up ...	26	134, 135
" Ball, standard ...	28	142-144
" formed by Couplings ...	27	139-141
" Knife-edge ...	25	132
" Reinforced ...	25	133
" Roller, built-up ...	24	131
" Roller, small ...	26	136
" Roller, Standard ...	27	137, 138
Bell Crank ...	43	267
Belt and Rope Mechanism ...	4	15-20
Bogies ...	37, 39	211a, 219
Brake, Double Band, Screw-operated ...	20	106
" Internal Expanding ...	19	104
" Reversing Friction ...	21	110
" Strap and Lever ...	19, 21	101, 109
" Strap and Screw ...	20	105
" Strap and Weighted Lever ...	19	102
Bucket Conveyor ...	40	232
" for Excavator ...	40	233
Cams or Tappets ...	43	264, 266
Centrifugal Governor ...	20	107
Chain Gear ...	3	6
Clock Escapement ...	20	108
Clutch, Automatic ...	18	86
" Belt ...	4	18a
" Dog: see Dog Clutch Mechanism —	—	—
" Epicyclic Gear ...	16	82
" Friction ...	9	61
" Gear ...	9	62
Controller, Electric Motor ...	23	115
Conveyor, Bucket ...	40	232
Crank Stroke, to increase length of ...	46	278
Crankshaft, Built-up ...	45	274
Crosshead ...	45	275
Differential Gear ...	41	251
Discharge, Automatic ...	35	201
Dog Clutch Mechanism ...	9, 11, 14, 15	63, 63, 73-75, 79, 80, 81a
Dredging Apparatus, Bucket ...	40	232
Drive Changing Gear ...	10, 12, 13	64, 65, 69-72
End Bearing for Connecting Rod ...	47	283
Endless Rope Traversing Gear ...	38	215
Epicyclic Gear Clutch ...	16	82
" Transmission Gear ...	16	83
Epicycloidal Gear ...	43	268
Escapement, Clock ...	20	108
Flexible Coupling (Universal Joint) ...	44	272
Free Wheel Device ...	21	112

Description.	Page.	S.M. No.
Gear, Belt ...	4	15-20
" Belt Reversing ...	4	18
" Bevel ...	3	3, 7
" Chain ...	3	6
" Change, Automatic ...	18	86
" Change, Dog Clutch ...	15	79, 80, 81a
" Change, Levers ...	14	76-78
" Change, Sliding ...	15	81
" Change: see Drive-changing Gear —	—	—
" Contrate ...	3	4, 8
" Planetary ...	17	84
" Ratios ...	3	1-8
" Worm ...	3	5
Governor, Centrifugal ...	20	107
" Speed, for Electric Motor ...	22	113
Grab ...	40	234
Hand Lever, Types of ...	8	52-54
Handles, examples of Meccano ...	42	255-259
Hinge Construction ...	47	281
Hoist, Automatic Reversing ...	7	42
" Chain ...	35	203
Hoisting Gear Driven by Screw Mechanism ...	33	183
Indicator, Jib Radius ...	47	282
" Speed ...	44	273
Intermittent Motion ...	43	264-266
" Rotary Motion ...	18, 43	87, 265
Jib Raising Gear, Screw-operated ...	32, 33	181, 184
Knife-edge Bearings ...	25	132
Lever, Types of hand ...	8	52-54
" Universal, for Clockwork Motor ...	8	55
" Gear Change ...	14	76-78
" in Platform Scales ...	8	51
Lock Nuts, Bolt and ...	42	263
Locking Devices ...	34	186, 187
Measurement of Angles ...	43	269
Multiple Drive Mechanism ...	44	271
Oscillating Cylinders ...	45	276
Overhead Gear for Electric Loco ...	42	261
" Travellers for Gantry ...	35, 36	202, 204-206
" Trolley with Chain Hoist ...	35	203
Pantograph ...	42	261
Pawl and Ratchet Gear ...	19, 46	103, 277
Federal ...	42	260
Pivot formed from Bolt and Nuts ...	42	262/3
Planetary Gear Box ...	17	84
Protractor, The Meccano ...	43	269
Pulley, Deep-grooved (Single Sheave) ...	6	39a

Description.	Page.	S.M. No.
Pulley Deep-grooved (Double Sheave) ...	36	205
" Guide ...	6	39, 40
" Single Movable ...	5, 6	33-35, 38
" Swivelling Jib Head ...	7	44
" Blocks, Pivoted to Jib ...	7	43
" Standard ...	5	29-31
" Three-sheave ...	5	32, 36
" Variable ...	6	41
Quick Return Motion ...	39	218
Rack and Pinion Traversing Mechanism ...	37	212
Reciprocating Engine Mechanism ...	45	274-6
" Motion ...	38, 41, 43	217, 252, 264/6
Retarding Appliances: see Section VI —	—	—
Reversing Gear ...	10, 13	64, 65, 71
" Bevel ...	11	66
" Belt ...	4	17, 18
" Dog Clutch ...	11	68
" Two-speed ...	11	67
" Hoist, Automatic ...	7	42
Roller Bearings: see under Bearings —	—	—
Safety Catch for Winding Gear... ..	21	111
" Device for Lifts ...	23	116
Screw Gear ...	20, 32-34	105, 106
Shovel for Giant Excavator ...	40	231
Speed Indicator ...	44	273
Spring, Laminated Cantilever ...	41	253
" Semi-elliptic ...	29	161
Steering Gear ...	29-31	161-168
" Boat ...	31	167
" Worm and Chain ...	31	166
" Worm and Pinion ...	29	162
Sun and Planet Mechanism ...	46	279
" Winding Gear ...	17	85
Switch, Automatic ...	22	114
Tappets: see Cams ...	—	—
Transmission of Power to Road Wheels ...	38, 39	216, 220
Travelling Carriage, self hauled... ..	38	214
Travellers, Overhead, for Gantries ...	35, 36	202, 204-206
Traversing Mechanism ...	37-39	211-220
" Application of Screw Gear in ...	32	182
" Truck with Automatic Discharge ...	35	201
Universal Joint or Coupling ...	44	272
Variable Rotary Drive ...	44	270
Winding Gear for Cranes ...	46	277
Worm Gear ...	3	5

"MECCANO MAGAZINE"



The
World's
Best
Magazine
for Boys



Published
Monthly

Price
SIXPENCE



Aeronautics
Railways
Stamps
Latest
Patents
Electricity

The "Meccano Magazine" is the Meccano boy's newspaper. He reads it regularly and corresponds with his friend the Editor when he feels inclined.

The Magazine tells him of the latest Meccano models; what Meccano Clubs are doing; how to correspond with other Meccano boys; the Competitions that are running. It contains splendid articles on

such subjects as Railways, Famous Engineers and Inventors, Electricity, Bridges, Cranes, Wonderful Machinery, Aeroplanes, Latest Patents, Radio, Stamps, Photography, Books and other topics of interest to boys, including suggestions for new Meccano parts and correspondence columns in which the Editor replies to his readers' enquiries. The publishing date is the 1st of each month.

Wonderful
Machinery

Lives of
Famous
Inventors

Competitions

Write to the Editor, "Meccano Magazine," Old Swan, Liverpool, enclosing 6d. in stamps. He will then forward a specimen copy of the "M.M.," post free. If you wish to become a regular subscriber the rates are 4/- for six issues or 8/- for twelve issues, post free.

If you prefer to do so, you may order the Magazine from your Meccano dealer or from any newsagent or bookstall, price 6d. Order early to avoid disappointment.

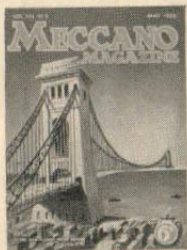

MECCANO PRICE LIST

COMPLETE OUTFITS

No. 00	Meccano	Outfit	3/6
" 0	"	"	5/-
" 1	"	"	10/-
" 2	"	"	16/-
" 3	"	"	27/6
" 4	"	"	50/-
" 5	"	" (Carton)	65/-
" 5	"	Presentation Outfit	95/-
" 6	"	Outfit (Carton)	115/-
" 6	"	Presentation Outfit	150/-
" 7	"	"	365/-

ACCESSORY OUTFITS

No. 00A	Meccano	Accessory	Outfit	1/6
" 0A	"	"	"	5/6
" 1A	"	"	"	7/-
" 2A	"	"	"	12/6
" 3A	"	"	"	23/6
" 4A	"	"	"	15/-
" 5A	"	"	" (Carton)	50/-
" 5A	"	"	" (Wood)	80/-
" 6A	"	"	"	200/-
Special	Inventor's	Outfit..	17/6

MOTORS, Etc.

Meccano	Clockwork	Motor	7/6
"	Electric	Motor No. 1 (6-Volt)	15/6
"	Accumulator	(6-Volt, 20 Amps.)	28/6
Resistance	Controller	3/6
Transformer	30/-

Patents and Designs
Great Britain

20,535/13	290,121
22,962/13	648,958
4,564/15	671,484
139,125	671,485
177,430	671,534
250,378	686,112
253,236	698,054

MECCANO

THE TOY THAT MADE ENGINEERING FAMOUS

Millions of boys in every country throughout the world play with Meccano. These are the Meccano Factories and distributing centres.

Patents and Designs
Great Britain

671,790	718,404
680,416	718,731
682,208	733,541
682,209	733,542
682,934	740,413
683,011	740,723



London Warehouse :
Meccano Ltd.,
5/6, Marshall Street,
London, W.1.

London Office & Warehouse :
Meccano Ltd.,
Walnut Tree Walk,
Kennington Road, London, S.E.11.

Meccano Agencies :

Algiers,	Amsterdam,
Auckland,	Barcelona,
Basle,	Bogota,
Bombay,	Brussels,
Buenos Aires,	Cape Town.

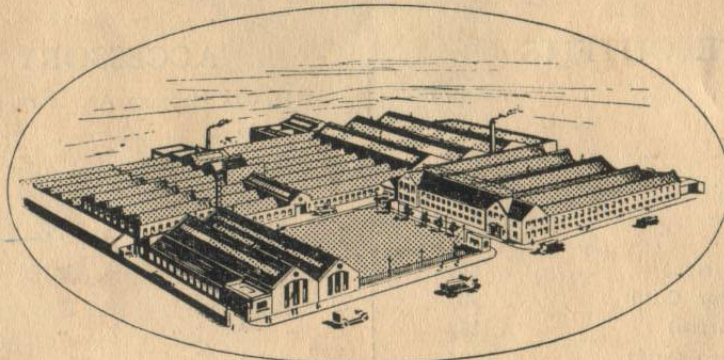

Head Office and Factory :
OLD SWAN, LIVERPOOL.

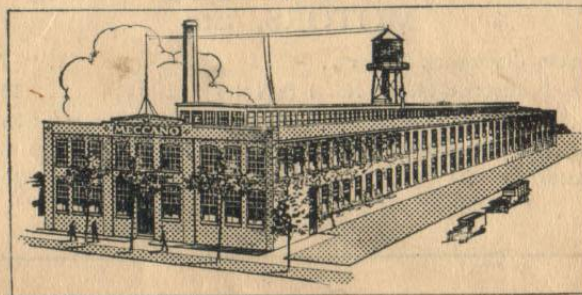

Meccano Company Inc.,
Elizabeth, New Jersey, U.S.A.



Meccano (France) Ltd.,
78-80 Rue Rebeval,
Paris XIXeme.

Meccano G.m.b.H.,
Alte Jacobstrasse 20-22 (Bergmannshof),
Berlin S.W.68.

Canadian Office and Warehouse :
Meccano Ltd.,
45, Colborne Street, Toronto.

Meccano Agencies :

Constantinople,	Malta,
Durban,	Monte Video,
Genoa,	Oslo,
Iquitos,	Stockholm,
Johannesburg,	Sydney.